



HAL
open science

Measuring and Monitoring Progress Towards the Circular Economy - Application to the Heavy Vehicle Industry

Michael Saidani, Bernard Yannou, Yann Leroy, François Cluzel

► **To cite this version:**

Michael Saidani, Bernard Yannou, Yann Leroy, François Cluzel. Measuring and Monitoring Progress Towards the Circular Economy - Application to the Heavy Vehicle Industry. PhD Student-Company Meeting Day, Apr 2018, Gif-sur-Yvette, France. hal-01954813

HAL Id: hal-01954813

<https://hal.science/hal-01954813v1>

Submitted on 20 Dec 2018

HAL is a multi-disciplinary open access archive for the deposit and dissemination of scientific research documents, whether they are published or not. The documents may come from teaching and research institutions in France or abroad, or from public or private research centers.

L'archive ouverte pluridisciplinaire **HAL**, est destinée au dépôt et à la diffusion de documents scientifiques de niveau recherche, publiés ou non, émanant des établissements d'enseignement et de recherche français ou étrangers, des laboratoires publics ou privés.

Towards a Circular Economy of Heavy Vehicles



Absence of EoL regulations, lack of infrastructures, illegal exports, env. burden, eco. loss, etc.

- Resources used
- Desk-based research
 - Field-based research
 - Research papers
 - Reports
 - Regulations
 - Websites
 - Databases
 - Internship
 - Interviews:
 - in person during planned meetings;
 - by audio;
 - Site visits
 - Thematic day: conference and workshop

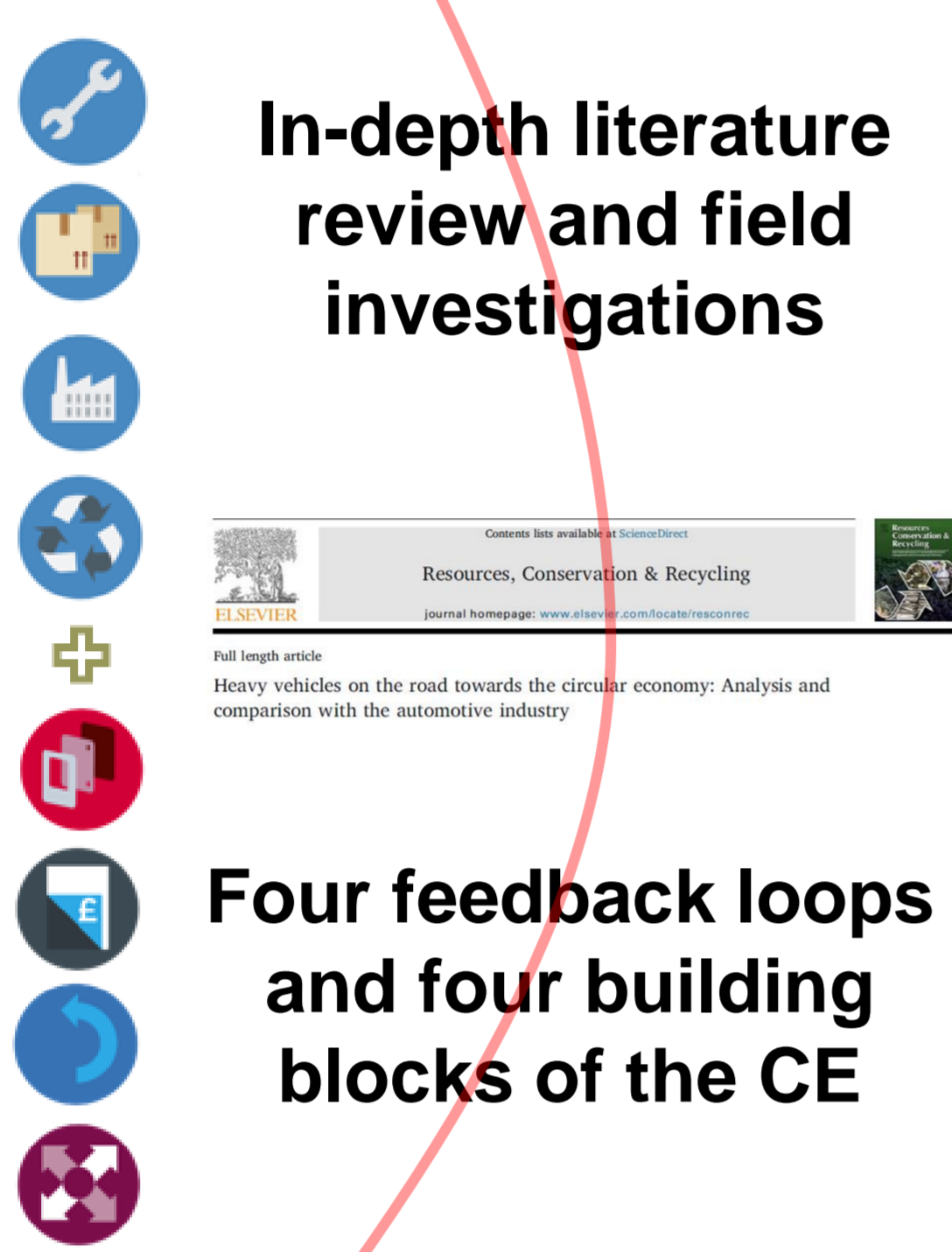

Identification of best practices and key action levers to close-the-loop

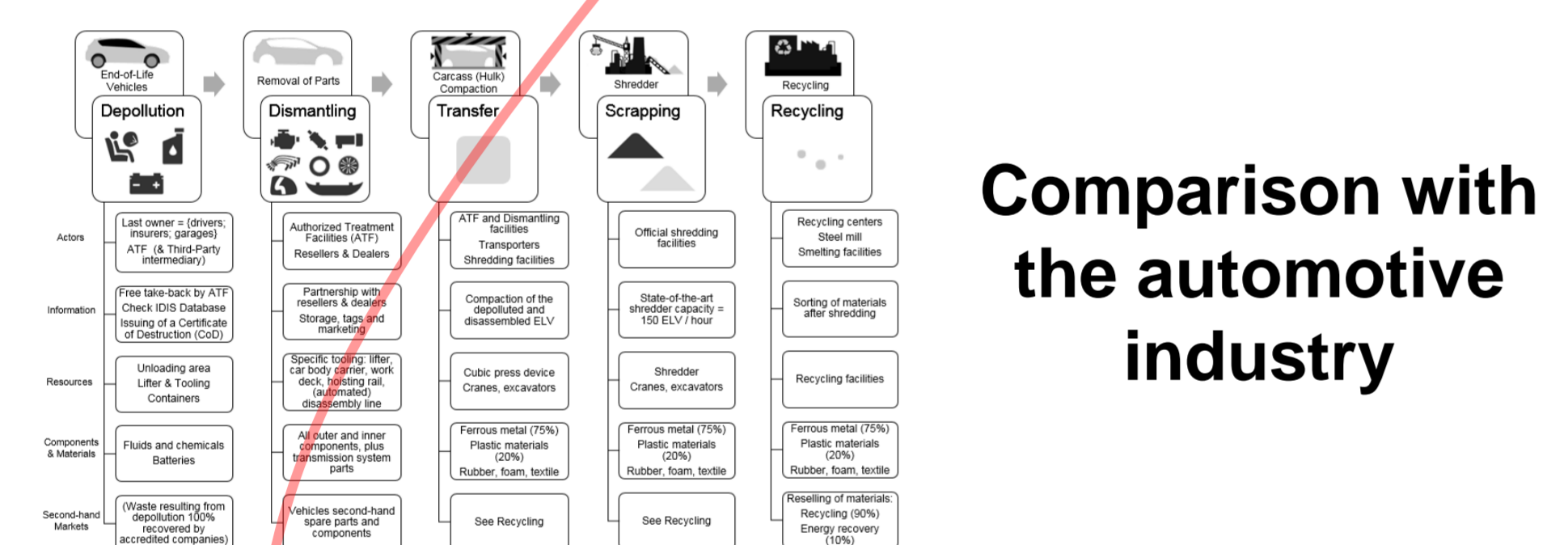
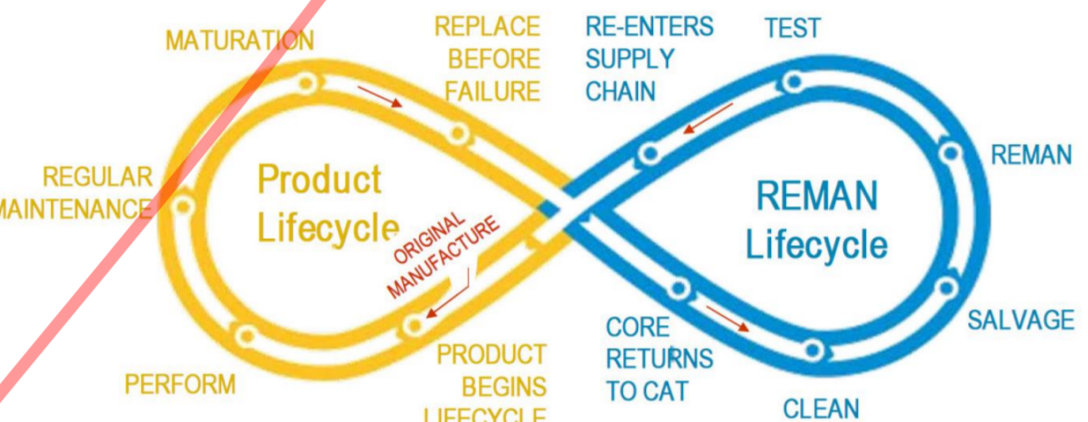

Application on an industrial pilot study with Manitou Reman

Features of the brand new heavy vehicle	Features of the used heavy vehicle	Economic and environmental costs of the dismantling operations
Parts breakdown	Bill of materials with mass, components geographical origin, production price and brand new selling price	Current stock vs. monthly sale
		Economic and environmental comparison between reuse, remanufacturing and recycling, for each component, where possible
		Selected end-of-life option

Eco, env, tech, org, analysis of the reconditioning of a used machine



Assess - Circularity Indicators adapted to Designers and Industrialists

Important degree of fuzziness and limitations
 Growing number of circularity indicators

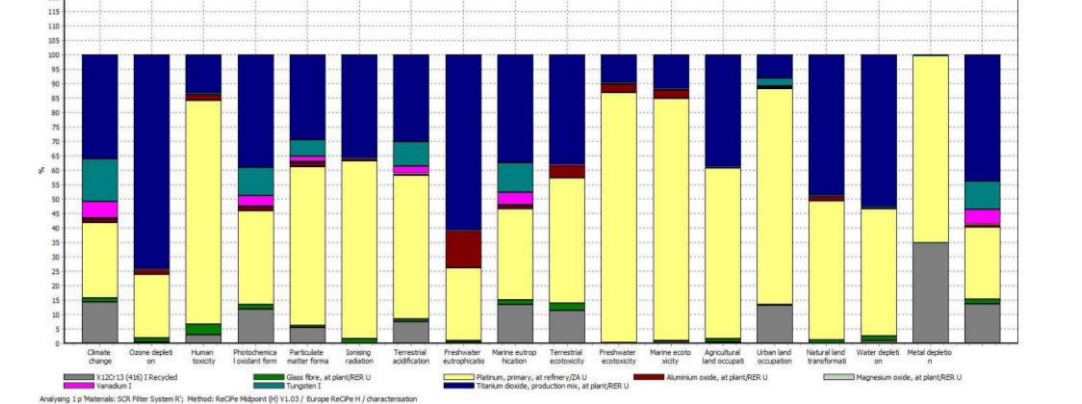
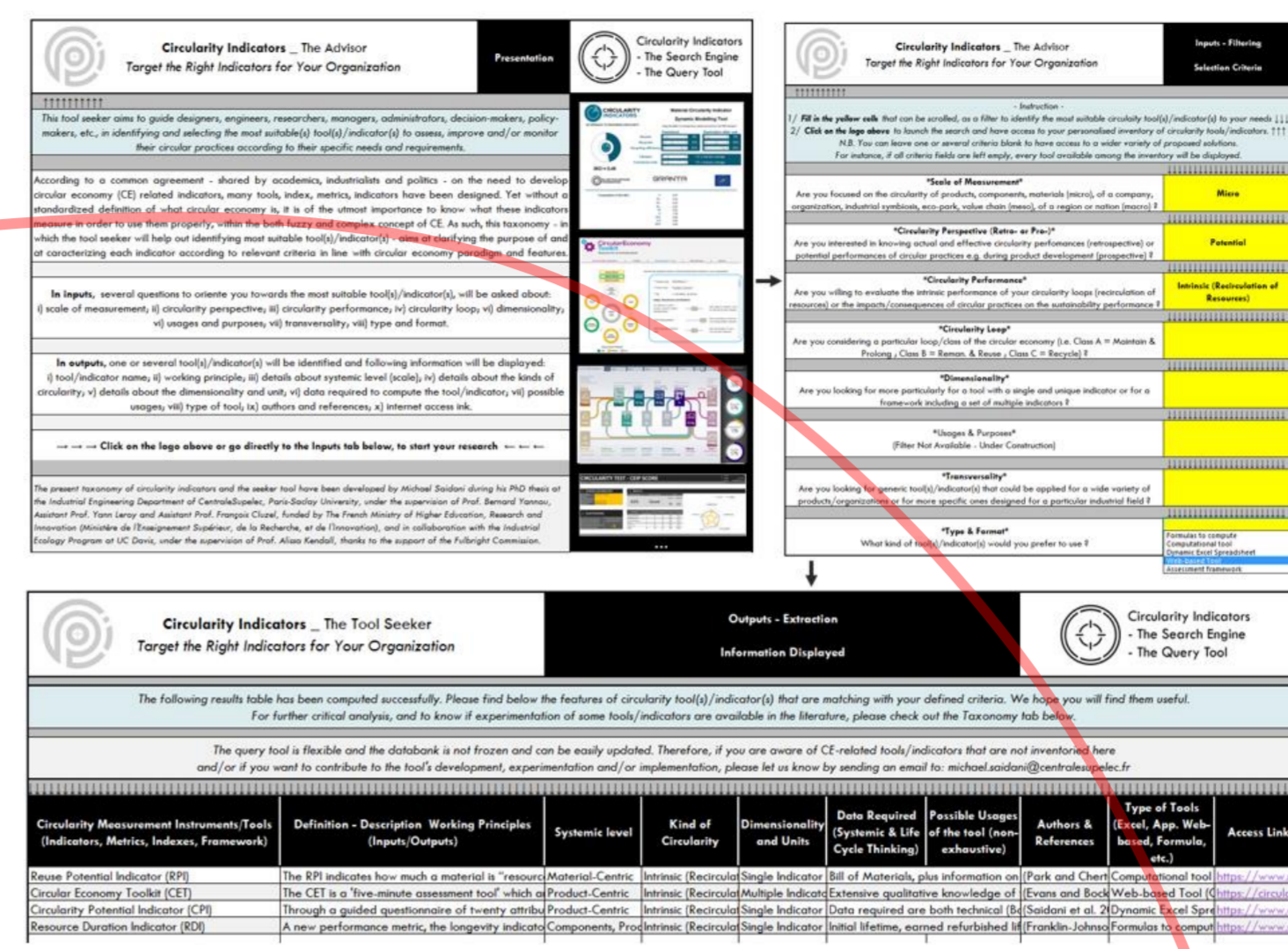
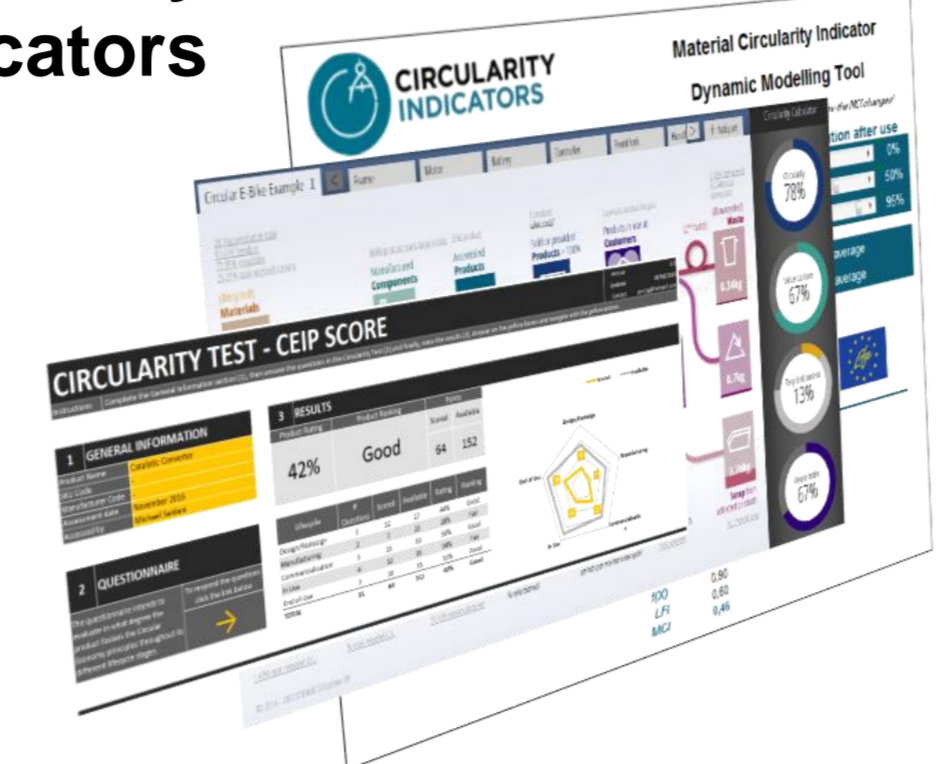

Life-Cycle Impact Assessment

Need-based taxonomy of 50 sets of CI
 "CI: The Advisor" Excel-based query tool

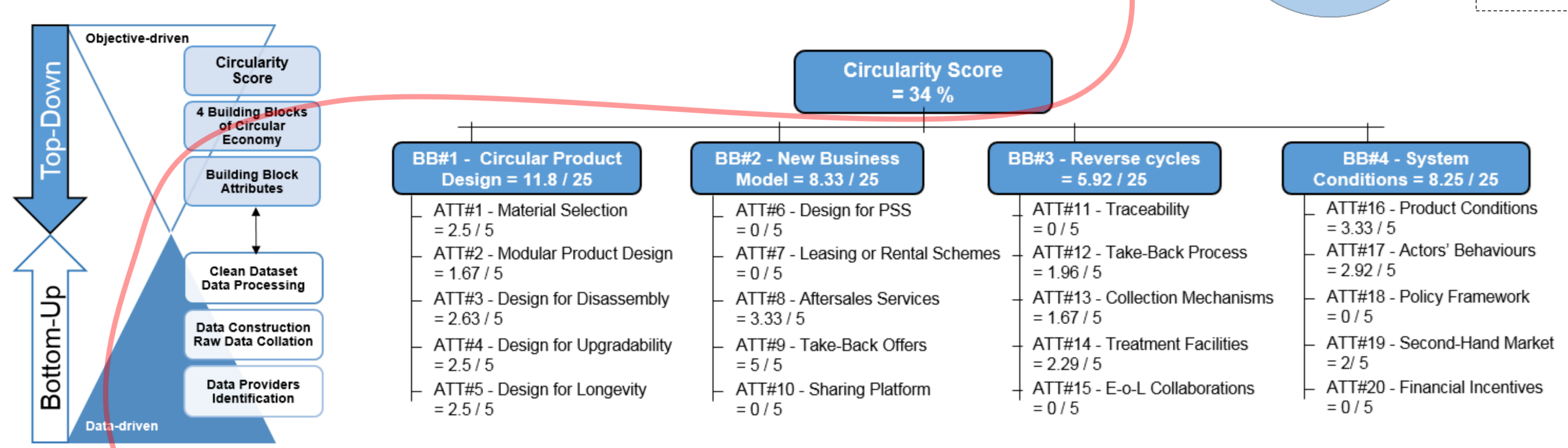

Development of a Circularity Potential Indicator, including 20 attributes, based on the 4 building blocks of the CE



LIEBHERR

Application on an Industrial Case Study

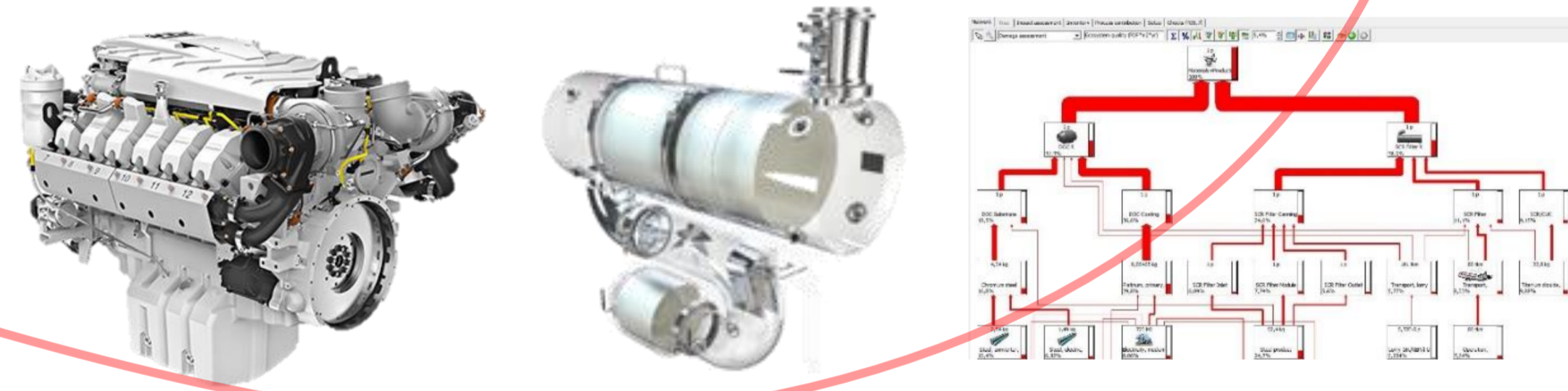

System Modeling

Improve - How to "Close-the-Loop" on Platinum from Catalytic Converters?

Highlight of important economic and environmental value buckets for European stakeholders

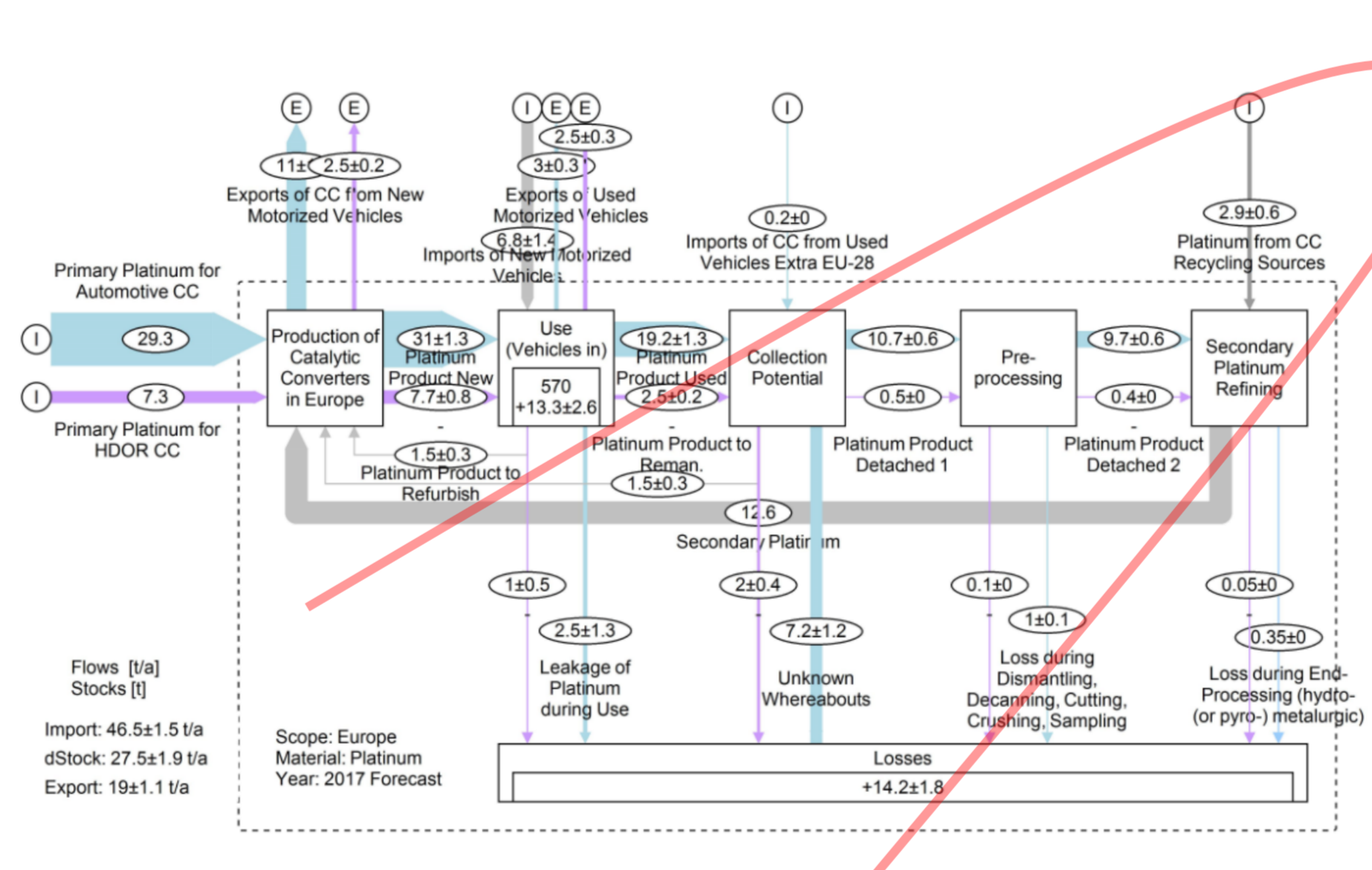

12th Society And Materials International Conference
 IF Steelman, m2p, ArcelorMittal, SAM 12

2017 Joint Conference ISIE and ISSST
 International Society for Industrial Ecology, International Symposium on Sustainable Systems and Technology (ISSST)

Presentations at French & International Conferences

Designing a multi-tool method to model and simulate circularity performance

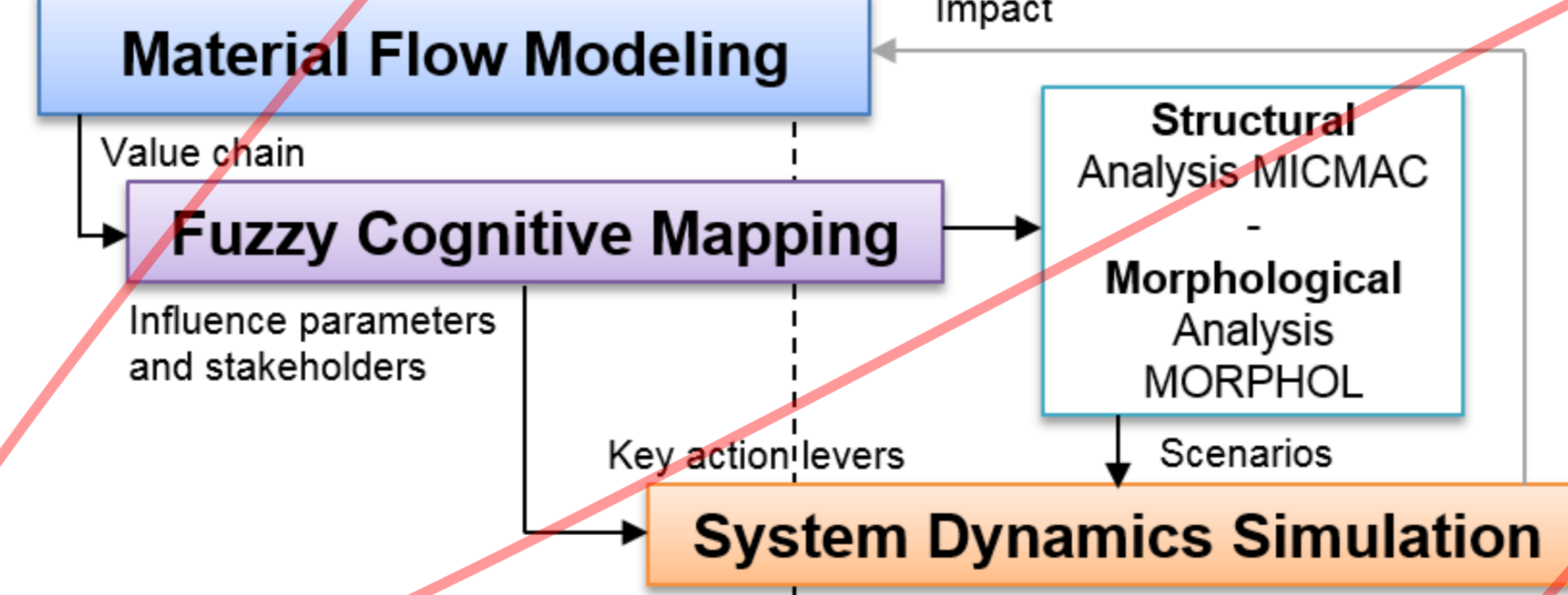

"What if?" scenarios to evaluate the environmental and economic impacts of CE related strategies

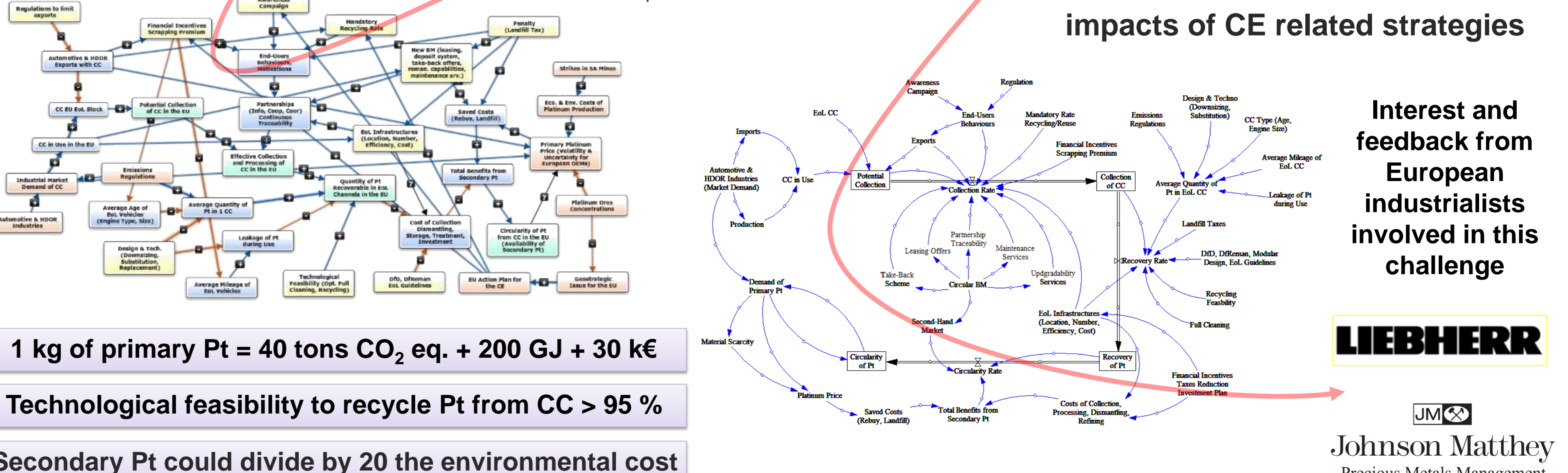

- 1 kg of primary Pt = 40 tons CO₂ eq. + 200 GJ + 30 k€
- Technological feasibility to recycle Pt from CC > 95 %
- Secondary Pt could divide by 20 the environmental cost

Interest and feedback from European industrialists involved in this challenge

