



HAL
open science

SLALOM: Open-Source, Portable and Easy-to-use Solar Cell Optimizer. Application to the Design of InGaN and CZTS Solar Cells.

Sidi Ould Saad Hamady, Nicolas Fressengeas

► To cite this version:

Sidi Ould Saad Hamady, Nicolas Fressengeas. SLALOM: Open-Source, Portable and Easy-to-use Solar Cell Optimizer. Application to the Design of InGaN and CZTS Solar Cells.. 35th European Photovoltaic Solar Energy Conference and Exhibition, Sep 2018, Bruxelles, Belgium. , 2018. hal-01948505

HAL Id: hal-01948505

<https://hal.science/hal-01948505>

Submitted on 7 Dec 2018

HAL is a multi-disciplinary open access archive for the deposit and dissemination of scientific research documents, whether they are published or not. The documents may come from teaching and research institutions in France or abroad, or from public or private research centers.

L'archive ouverte pluridisciplinaire **HAL**, est destinée au dépôt et à la diffusion de documents scientifiques de niveau recherche, publiés ou non, émanant des établissements d'enseignement et de recherche français ou étrangers, des laboratoires publics ou privés.

SLALOM: Open-Source, Portable and Easy-to-use Solar Cell Optimizer.

Application to the Design of InGaN and CZTS Solar Cells.

Sidi OULD SAAD HAMADY ^{(1,2,*),} Nicolas FRESSENGEAS ^(1,2)

¹ Université de Lorraine, Laboratoire Matériaux Optiques, Photonique et Systèmes, Metz, F-57070, France

² Laboratoire Matériaux Optiques, Photonique et Systèmes, CentraleSupélec, Université Paris-Saclay, Metz, F-57070, France

* sidi.hamady@univ-lorraine.fr

Summary

The development of new thin films solar cells is highly accelerated by using rigorous optimization approach. A large set of parameters is involved in the solar cell operation: active layer thickness, composition, bandgap, doping, contacts, etc. The study of the solar cell performances with respect to these linked parameters is necessary to better understand the underlying physics and to optimize the final device. We propose in this poster presentation (*) a new open-source solar cell optimizer: SLALOM for SoLAR ceLL multivariate OptiMizer. SLALOM implements, for the first time for solar cells, a rigorous multivariate approach while the standard optimization work used to use the one-by-one parameter procedure. SLALOM is implemented to be easily extended to any simulator, the core code itself does not depend on any particular engine. It can be adapted for any solar cell structure, runs locally or remotely on a calculation server, using the SSH protocol and includes a graphical user interface to real-time monitor the optimization. Two study cases, InGaN and CZTS solar cells, are presented to show the SLALOM ability to become a useful tool for the development of novel solar cells.

(*) Article independently submitted to EPI Photovoltaics

SLALOM: principle, implementation and application to InGaN and CZTS solar cells

CLASSICAL OPTIMIZATION METHOD: THE PARAMETRIC ANALYSIS

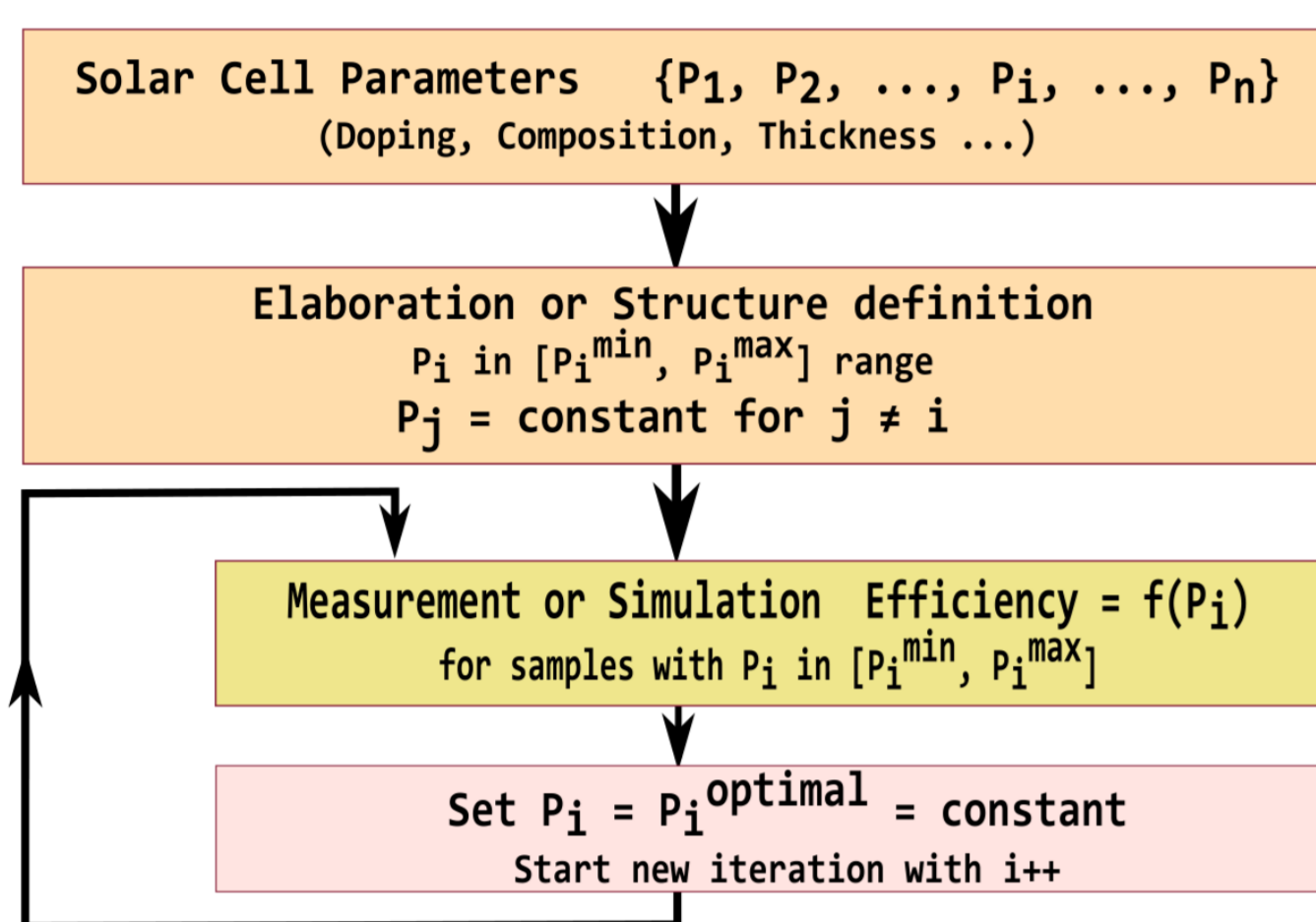

One-by-one parametric analysis steps (cf. figure):

- defining a set of technological and physical parameters: composition, doping concentrations, layers thicknesses...
 - defining the set of samples to simulate
 - simulating these samples to extract the photovoltaic efficiency
- The sample for which the efficiency is optimal is then identified and the varying parameter set to the optimal value. The procedure then iterates for the next parameter, keeping all other parameters constant...

Advantage:

→ simplicity

Disadvantages:

- mathematical uncertainty: at the end of the procedure, the highest obtained efficiency is not guaranteed to be the optimal one since the procedure ignores the interdependence between the solar cell parameters
- huge number of evaluations of the efficiency

SLALOM: RIGOROUS OPTIMIZATION METHOD

SLALOM (SoLAR ceLL multivariate OptiMizer):

- uses state-of-the-art mathematical optimization algorithms to find the parameter set that yields the optimal solar cell efficiency
 - takes the interdependence between the parameters into account
 - minimizes the computing time, if compared to the classical method
- Procedure steps:
- defining a set of parameters pertaining to the solar cell operation (e.g. composition, doping concentrations, layers thicknesses...)
 - using a semiconductor simulation engine that allows the numerical evaluation of the solar cell efficiency from its parameters (cf. figure)
 - using a mathematical algorithm designed to find the parameter vector that maximizes the efficiency using a numerical iterative procedure

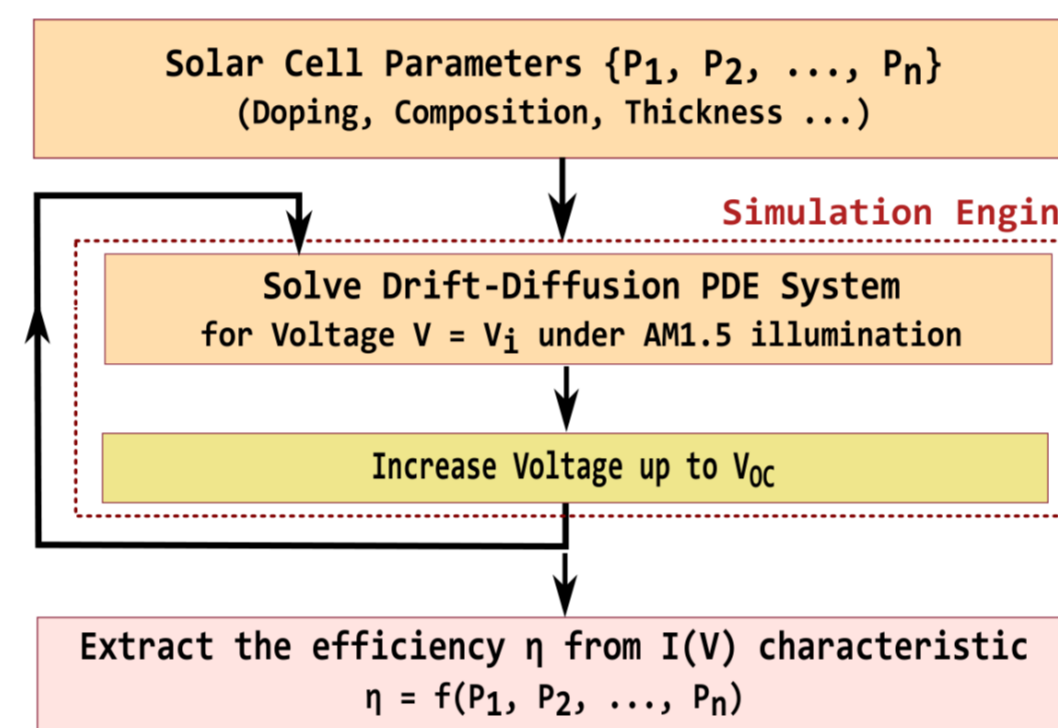

Used mathematical optimization algorithms:

- Sequential Least Squares Programming (SLSQP) method: starting from an initial guess, it uses Newton's method to find the optimum
- Broyden-Fletcher-Goldfarb-Shanno (BFGS) iterative algorithm: it uses a quasi-Newton method to find the optimum using gradient evaluations and approaching the second derivatives

SLALOM: IMPLEMENTATION

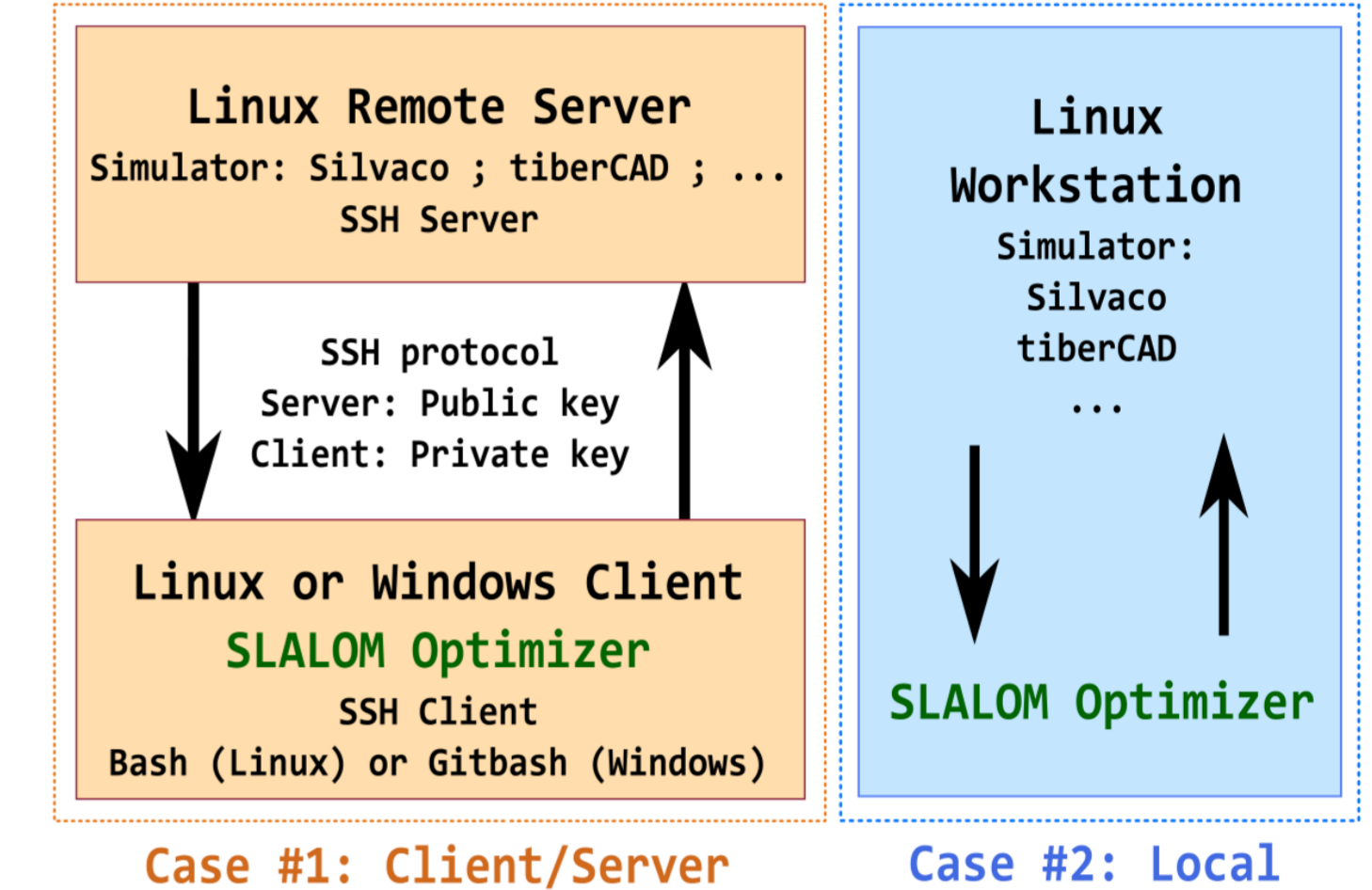

SLALOM is written in Python, It uses the SciPy and NumPy numerical packages, Tkinter for the user interface and Matplotlib for 2D curve plotting. Figures shows the SLALOM general architecture.

SLALOM modules:

- `slalom.py`: the SLALOM startup module: sets the parameters, the optimization method and controls the whole process
- `slalomCore.py`: the SLALOM core class: implements the optimization using mathematical algorithms and controls the device simulation engine
- `slalomDevice.py` is a class defining a set of devices (e.g. InGaN PN, CZTS NP...) for easier and more robust optimization work
- `slalomDeviceGui.py` is a class providing an interface to create a new device type

SLALOM is distributed under MIT license for free use, modification and redistribution. Its source code is freely available for download and use from:

→ <https://github.com/sidihamady/SLALOM>

→ http://www.hamady.org/photovoltaics/slalom_source.zip

APPLICATION TO INGAN AND CZTS SOLAR CELLS

InGaN and CZTS solar cells optimized using SLALOM.
The used backend simulator engine is Silvaco® Atlas®.

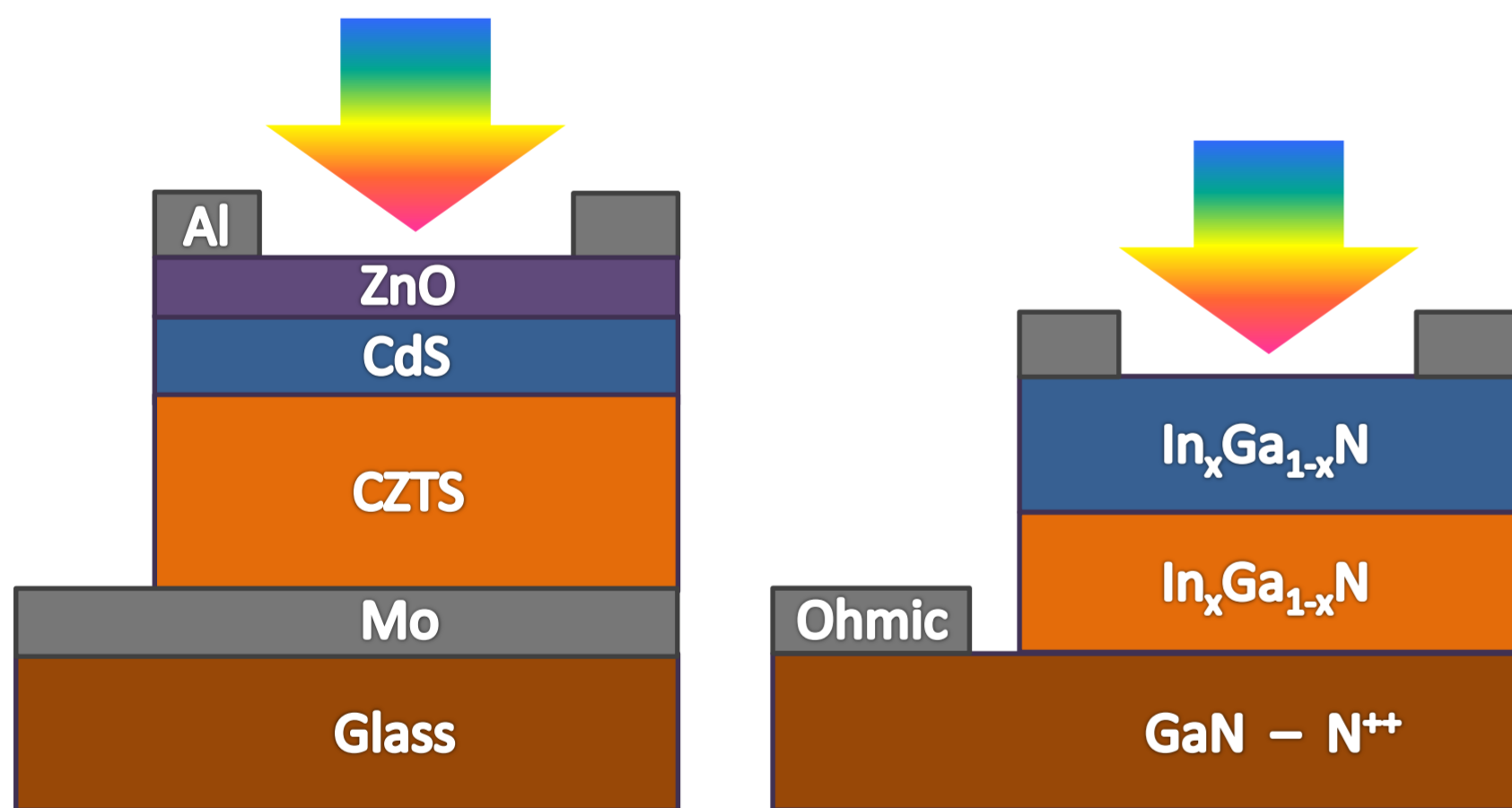

→ Illumination : 1 Sun with AM 1.5G Solar Spectrum.
→ InGaN Bandgap, Affinity, Effective density of states, Permittivity, Absorption, SRH, Auger and direct recombination, Band discontinuity, Tunneling current, Polarization/Piezoelectric parameters, ...: taken from literature and/or extracted from experimental data.

Parameters [1]	InN	GaN	CZTS
Bandgap (eV)	0.7	3.42	1.5
Affinity (eV)	5.6	4.1	4.5
Carrier lifetime (ns)	1	1	1000
Permittivity	15.3	8.9	10
N_c (cm ⁻³)	9.1×10^{17}	2.3×10^{18}	2.2×10^{18}
N_v (cm ⁻³)	5.3×10^{19}	4.6×10^{17}	1.8×10^{19}
Absorption	Extracted from experimental data [3]		
Mobility	Caughy-Thomas Model [4]		
Refractive Index	Adachi Model [5]		

[1] E Mattioli, C Neufeld, M Iza, S C Cruz, AA AlHeji, X Chen, RM Farrell, S Keller, S DenBaars, and U Mishra. High internal and external quantum efficiency InGaN/GaN solar cells. *Applied Physics Letters*, 98(2):021102, 2011.
[2] M Jiang and X Yan. Cu₂ZnSnS₄ thin film solar cells: present status and future prospects. *In Solar Cells-Research and Application Perspectives*. InTech, 2013.
[3] G Brown, J Ager III, W Walukiewicz and J. Wu. Finite element simulations of compositionally graded InGaN solar cells. *Solar Energy Materials and Solar Cells* 94 (3) (2010) 478-483.
[4] F Schwierz, An electron mobility model for wurtzite GaN. *Solid State Electronics* 49 (6) (2005) 889-895.
[5] AB Djurisic, EH Li, Modeling the optical constants of hexagonal GaN, InN, and AlN. *Journal of Applied Physics* 85 (5) (1999) 2848-2853.

OPTIMIZATION OF INGAN BASED SOLAR CELLS [6,7,8]

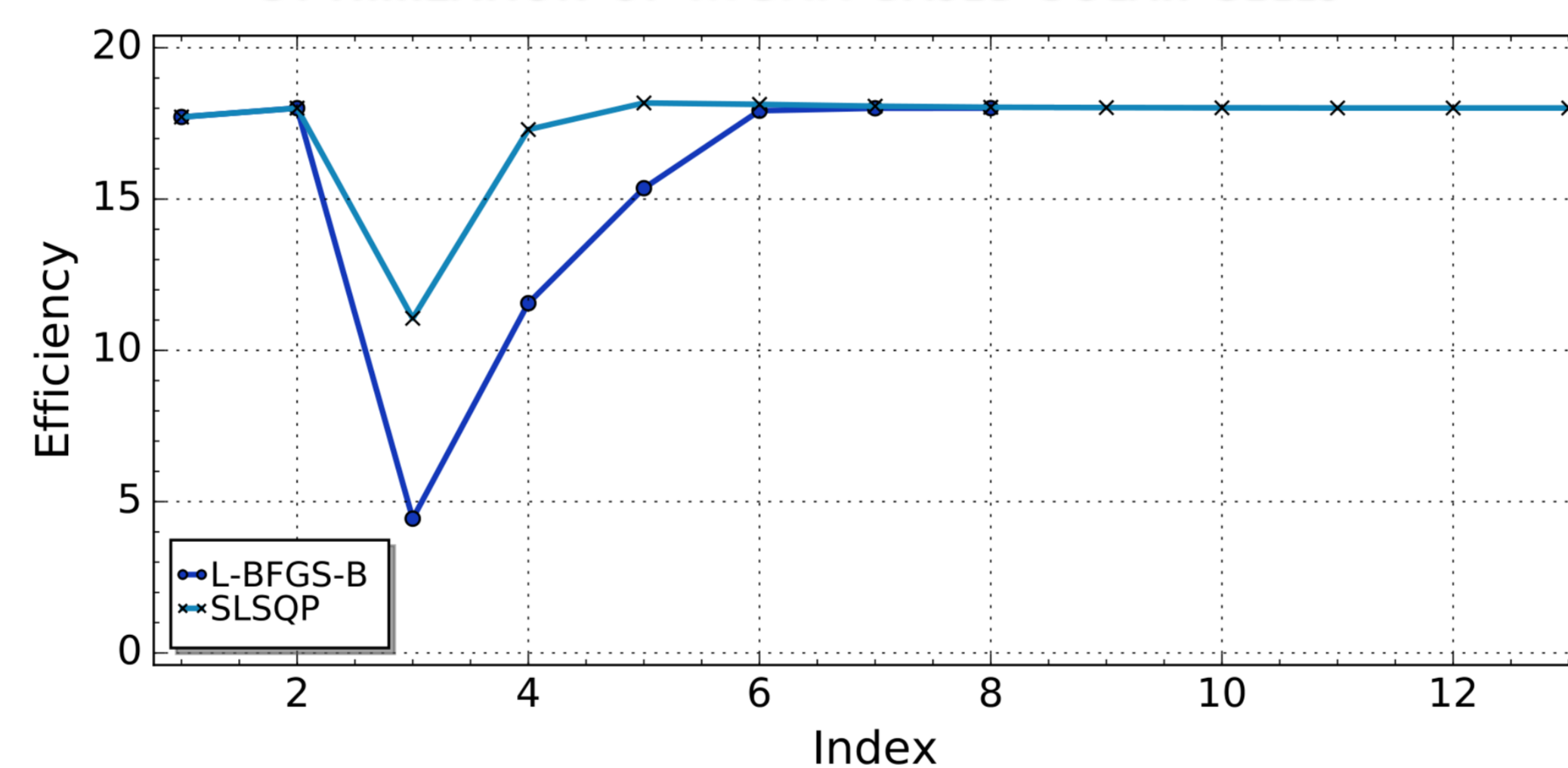

Efficiency of the InGaN PN solar cell determined by SLALOM using the L-BFGS-B and SLSQP methods: both methods converge to the same set of optimal parameters in about two hours for L-BFGS-B and one hour for SLSQP on a Red Hat Linux server with two 8-core Xeon processors and 32 GB of RAM. The InGaN simulation files for Silvaco® Atlas® are included in the SLALOM distribution.

The optimal set of parameters gives an optimal efficiency of about 18 %, a short-circuit current of 26.8 mA/cm², an open-circuit voltage of 0.85 V and a fill factor of 78 %, obtained for the following set of values: a P-layer thickness of 0.01 μm, an N-layer thickness of 1 μm, a P-layer doping of 10¹⁹ cm⁻³, an N-layer doping of 4×10¹⁶ cm⁻³ and an Indium composition of 56 %.

Current-voltage characteristic of the InGaN PN solar cell at the optimum:

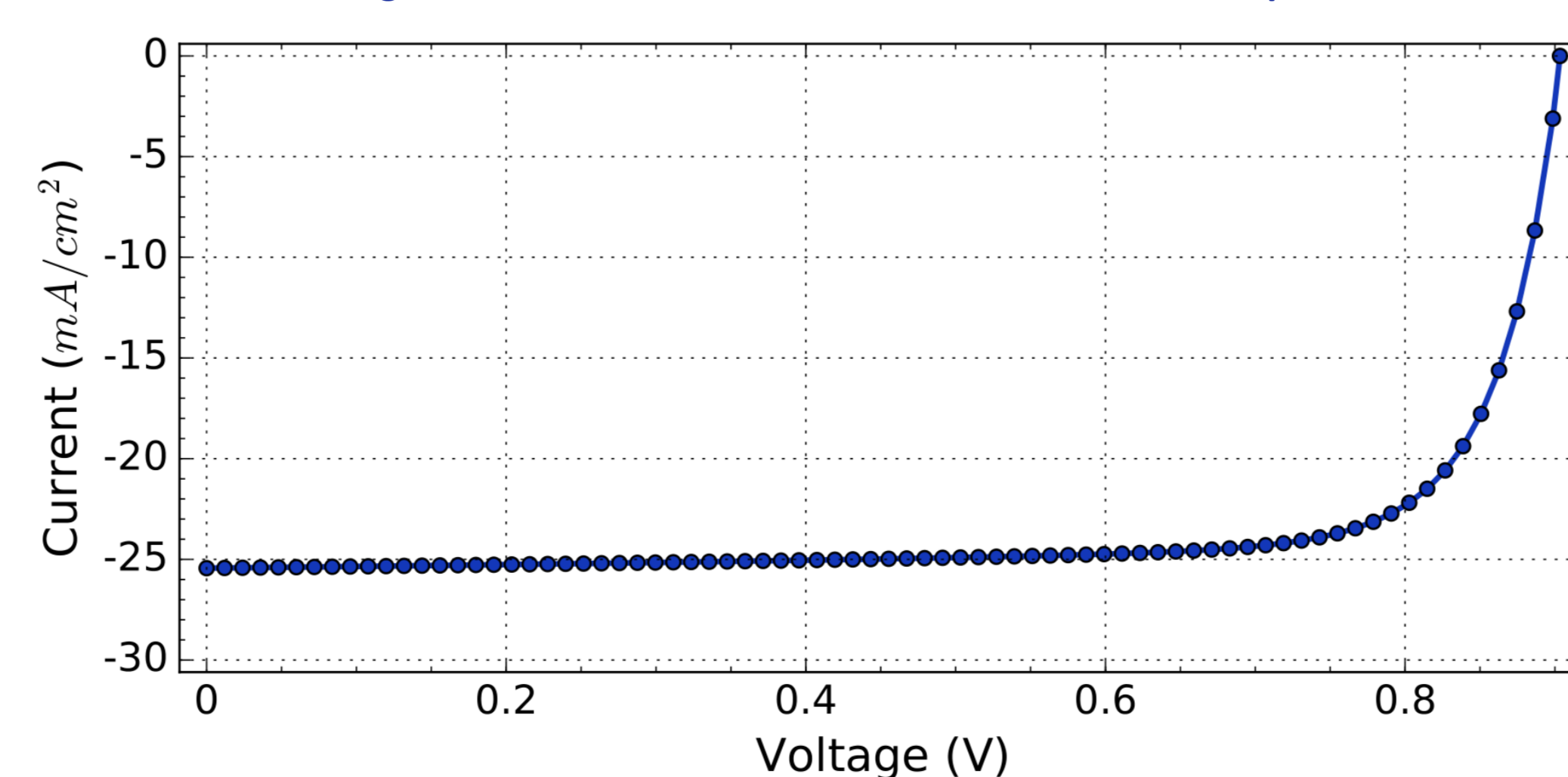

OPTIMIZATION OF CZTS BASED SOLAR CELLS

Copper Zinc Tin Selenide Cu₂ZnSnSe₄ (CZTS): abundance of elements and high photovoltaic performances. The CZTS simulation files for Silvaco® Atlas® are included in the SLALOM distribution.

The set of parameters chosen to be optimized are the CZTS absorber doping and thickness. The other data used in the simulation, such as the CZTS bandgap, mobilities and absorption coefficient and the CdS layer parameters, are fixed to their experimentally known values.

Optimal efficiency found by SLALOM: 20.5 % for a CZTS thickness of 1.3 μm and a doping concentration of 1.4×10¹⁵ cm⁻³. Efficiency is higher than the InGaN solar cell efficiency, showing the potential of this alternative material for photovoltaics.

The optimization duration was about three hours, more than ten times faster than rough parametric analysis.

Current-voltage characteristic for the optimal efficiency:

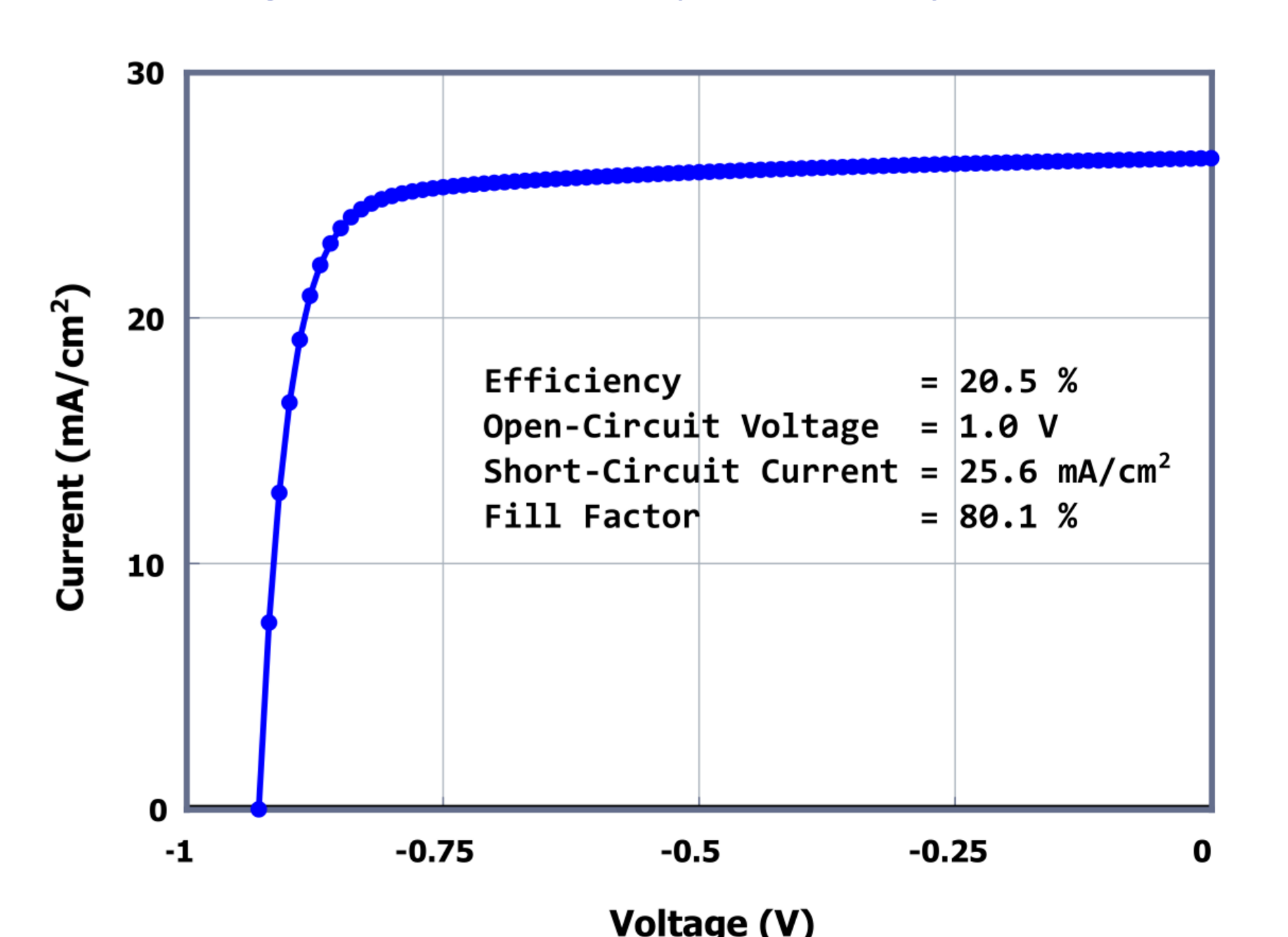

[6] S Ould Saad Hamady, A Adaine, and N Fressengeas. Numerical simulation of InGaN Schottky solar cell. *Materials Science in Semiconductor Processing*, 41:219-225, 2016.

[7] A Adaine, S Ould Saad Hamady, and N Fressengeas. Simulation study of a new InGaN p-layer free Schottky based solar cell. *Superlattices and Microstructures*, 96:121-133, 2016.

[8] Abdoulwahab Adaine, Sidi Ould Saad Hamady, and Nicolas Fressengeas. Effects of structural defects and polarization charges in InGaN-based double-junction solar cell. *Superlattices and Microstructures*, 107:267-277, 2017.