



HAL
open science

Combining Multi-Objective Optimization, Principal Component Analysis and Multiple Criteria Decision Making for ecodesign of photovoltaic grid-connected systems

Jorge Raúl Pérez-Gallardo, Catherine Azzaro-Pantel, Stéphan Astier

► To cite this version:

Jorge Raúl Pérez-Gallardo, Catherine Azzaro-Pantel, Stéphan Astier. Combining Multi-Objective Optimization, Principal Component Analysis and Multiple Criteria Decision Making for ecodesign of photovoltaic grid-connected systems. Sustainable Energy Technologies and Assessments, 2018, 27, pp.94-101. 10.1016/j.seta.2018.03.008 . hal-01948276

HAL Id: hal-01948276

<https://hal.science/hal-01948276>

Submitted on 7 Dec 2018

HAL is a multi-disciplinary open access archive for the deposit and dissemination of scientific research documents, whether they are published or not. The documents may come from teaching and research institutions in France or abroad, or from public or private research centers.

L'archive ouverte pluridisciplinaire **HAL**, est destinée au dépôt et à la diffusion de documents scientifiques de niveau recherche, publiés ou non, émanant des établissements d'enseignement et de recherche français ou étrangers, des laboratoires publics ou privés.





Open Archive Toulouse Archive Ouverte

OATAO is an open access repository that collects the work of Toulouse researchers and makes it freely available over the web where possible

This is an author's version published in: <http://oatao.univ-toulouse.fr/21109>

Official URL: <https://doi.org/10.1016/j.seta.2018.03.008>

To cite this version:

Perez Gallardo, Jorge Raúl  and Azzaro-Pantel, Catherine  and Astier, Stéphan  *Combining Multi-Objective Optimization, Principal Component Analysis and Multiple Criteria Decision Making for ecodesign of photovoltaic grid-connected systems*. (2018) *Sustainable Energy Technologies and Assessments*, 27. 94-101. ISSN 2213-1388

Any correspondence concerning this service should be sent to the repository administrator: tech-oatao@listes-diff.inp-toulouse.fr

Combining Multi-Objective Optimization, Principal Component Analysis and Multiple Criteria Decision Making for ecodesign of photovoltaic grid-connected systems

J. Raul Perez-Gallardo^{a,1}, Catherine Azzaro-Pantel^{a,*}, Stéphan Astier^b

^aLaboratoire de Génie Chimique, Université de Toulouse, CNRS, Toulouse, France

^bLAPLACE, Université de Toulouse, CNRS, Toulouse, France

A B S T R A C T

Photovoltaic grid-connected systems (PVGCS) promise to be a major contributor of the future global energy system. Even if no GreenHouse Gases (GHG) are emitted during their operation phase, emissions are generated by the use of fossil fuel-based energy during the manufacture, building and recycling of the components. An integrated ecodesign framework that simultaneously manages technical, economic and environmental criteria for the design and sizing of PVGCS (cradle-to-gate approach) is presented in this work. A Multi-Objective Optimization problem embedded in an external multi-objective Genetic Algorithm (NGSA II) optimization loop generates a set of Pareto solutions representing the optimal trade-off between the objectives considered. Then a decision-making tool (M-TOPSIS) selects the solution providing the best compromise. The Life Cycle Assessment (LCA) method was selected to assess the environmental impact. Five commercial PV technologies were evaluated to generate alternatives of PVGCS configurations through a set of 18 objectives (two technical and one economic criteria as well as the 15 midpoint categories of the IMPACT 2002+ method). After a statistical analysis of the first results, the Principal Component Analysis (PCA) method was applied to remove redundant objectives, thus leading to only four contradictory objectives. The results highlight the advantage of the use of thin-film PV modules over crystalline-Si based PV modules.

Introduction

Photovoltaic grid-connected systems (PVGCS), a “clean” energy supplier, represent an important alternative for dealing with the increasing demand for energy worldwide and the widespread damage caused by intensive use of fossil sources as well as for coping with the scarcity of fossil fuels by transforming incident solar energy to electricity [1]. Even if they do not generate any particulate matter emissions during the operation phase and require no fluid maintenance, emissions are generated by the use of fossil-fuel-based energy during the manufacture of the components, the building of the system and the subsequent recycling of the components [2,3].

The growing awareness in society for environmental issues has motivated the development of strategies that include environmental

consideration through the design process of a product or service especially for those labeled as eco-friendly. Integrating the environmental dimension into system design can yet result in a complex process. Indeed, the designer must ensure that the functions, techniques and technological solutions are integrated in an appropriate manner while respecting the best possible environmental performance over the whole life-cycle of the system. Ecodesign is the term used to group almost all the processes and approaches related to the integration of environmental considerations in the product or system design throughout their life-cycle [4] ensuring similar or improved services to the end customer [5,6].

Fargnoli and Kimura [7] evaluate some ecodesign tools considering six main properties able to address designers in choosing the most suitable design tools for the development of sustainable products,

Abbreviations: AA, Aquatic Acidification; AE, Aquatic Ecotoxicity; AEU, Aquatic Eutrophication; C, Carcinogen; CdTe, Cadmium-Telluride; CIS, Copper-Indium-Selenide; CUT, cut-off value; EPBT, Energy Payback Time; GA, Genetic Algorithms; GW, Global Warming; IR, Ionizing Radiation; LCA, Life Cycle Assessment; LO, Land Occupation; MCDM, Multiple Criteria Decision Making; ME, Mineral Extraction; NC, Non-Carcinogen; NR, Non-Renewable energy; OLD, Ozone Layer Depletion; PBT, Investment Payback Time; PC, principal component; PCA, Principal Component Analysis; PV, Photovoltaic; PVGCS, photovoltaic grid-connected systems; RA, Risk Assessment; RI, Respiratory Inorganic; RO, Respiratory Organic; a-Si, amorphous silicon; c-Si, crystalline-Silicon; m-Si, mono-crystalline; p-Si, poly-crystalline; TAN, Terrestrial Acidification/Nitrification; TE, Terrestrial Ecotoxicity; TF, thin film

Nomenclature

β	PV collector inclination angle, degree
A^+, A^-	ideal and non-ideal solution in M-TOPSIS method
a_{ij}	normalized result of alternative i into the criterion j
D	distance between PV sheds, m
D_{min}	minimum distance between PV sheds, m
D_i^+, D_i^-	Euclidean distance for ideal and non-ideal solution for alternative i
E_{max}	maximum PV collector height above ground, m
H	PV collector height, m
H_{max}	maximum PV collector height, m
K	number of PV sheds
L	solar field length, m
L_C	PV collector length, m
L_{max}	maximum solar field length, m

$Loss_{PV\eta}$	number of energy loss due to module efficiency, kWh
$Loss_{DC/AC\eta}$	number of energy loss due to DC/AC inverter efficiency, kWh
$Loss_{Shading}$	number of energy loss due to the shading effect, kWh
$Loss_{Mismatch}$	number of energy loss due to the mismatch, kWh
N_c	number of PV modules columns in the collector
N_r	number of PV modules rows in the collector
Q_{out}	yearly output energy of the field, kWh
Q_{MAX}	maximum incident energy that the PVGCS can receive, kWh
W	solar field width, m
W_{max}	maximum solar field width, m
v_{ij}	weighted normalized result of alternative i into the criterion j
w_j	weight of the individual criterion j
X_{ij}	value of alternative i into the criterion j

concluding that there is not one method that emerges significantly from others. This work highlights the advantages of using a quantitative method to assess the environmental performance of the product or service under study that has to be considered at the early design stage.

According to Sadler and Verheem [8], environmental assessment is defined as a systematic process for evaluating and documenting information on the potentials, capacities and functions of natural systems and resources in order to facilitate sustainable development planning and decision-making in general, and to anticipate and manage the adverse effects and consequences of proposed undertakings in particular. There are many different procedures and methods to assess the environmental issues or impacts such as Environmental Impact Assessment, Material Flow Analysis, Material Intensity per Unit Service, Risk Assessment (RA) and Life Cycle Assessment (LCA). LCA and RA methods are the most cited approaches in literature works to support decision-making in environmental management. The strengths and weaknesses of both methods have been reported by several authors [9,10]. It is generally highlighted that the boundaries of a risk analysis (including Risk Assessment and risk management) can be too narrow compared to those considered in LCA, encompassing the systemic environmental consequences of a typical product, process or service. The important distinction between LCA and more narrowly focused analytic approaches such as RA is the accounting of emissions and/or resource consumption such as extraction of raw materials, processing, distribution, use of the product, recycling and, disposal of final waste. This

motivates the choice of LCA as a systemic environmental assessment method. Let us recall that LCA is also widely used in industry [11,12] and allows comparing the assessment of the alternatives focused on a specific functional unit. It evaluates each life-cycle stage of the product under evaluation, classifies and characterizes the emissions in several and diverse environmental categories. More generally, LCA can be integrated into an environmental decision support tool combining social, political, economic and technical considerations, as highlighted in this work.

In the quest for more sustainable energy systems, the design of PVGCS is of tremendous importance. PVGCS, the most popular type of solar PV system, is integrated with three key elements: PV modules, DC/AC inverter, and mounting system. PV modules constitute the core of the system to convert solar energy into electricity. They are also the most sensitive component because the type of material used in their manufacture, the solar irradiance and weather condition principally affect their conversion efficiency. In general, the cost of the PV modules still dominates the price of large-scale PVGCS even if the prices of PV modules have been reduced substantially in recent years.

PV modules are grouped into first, second or third generation according to the technology used for solar cell manufacturing. The crystalline-Silicon technology (c-Si), i.e., the first generation includes modules made by silicon cells as mono-crystalline (m-Si) or poly-crystalline (p-Si). The so-called thin film (TF) PV modules are considered as second-generation of PV technologies. It includes three main families:

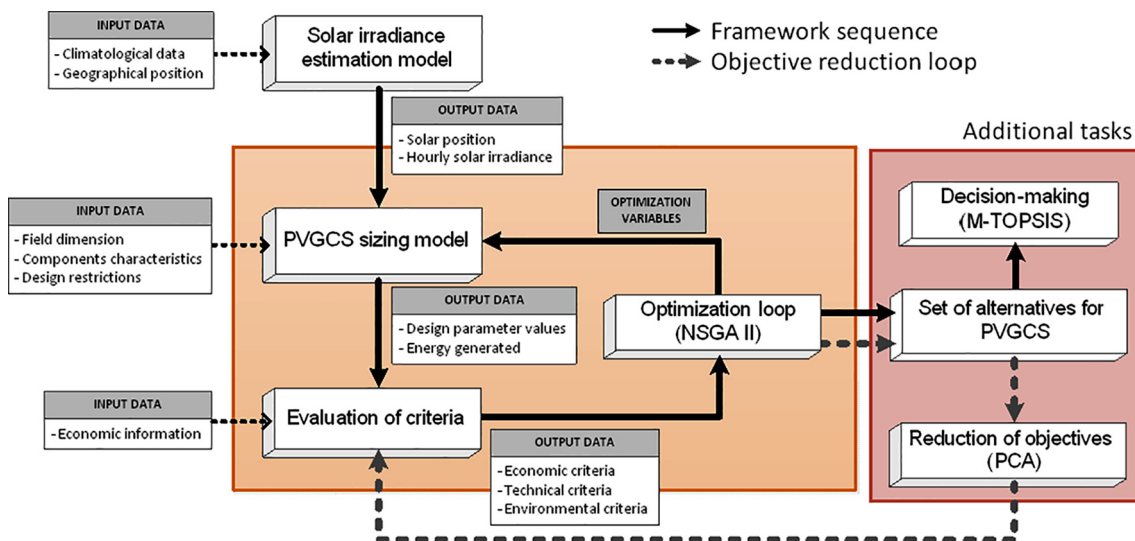

Fig. 1. Functional flow diagram of the Ecodesign methodology.

amorphous silicon (a-Si), Cadmium-Telluride (CdTe) and Copper-Indium-Selenide (CIS). There are four types of third-generation PV technologies: concentrating PV (CPV), dry-sensitized solar cells (DSSC), organic solar cells and, novel and emerging solar cell concepts. PV modules of first and second generations have currently the highest market share (more than 90%).

The main difference among PV technologies is related to the conversion efficiency of the PV module. Even if c-Si technologies have the highest performance, TF technologies have substantially improved their performance due to the advances in recent years [13]. The type of PV technology selected for a PVGCS has a big relevance depending on the context in which it will be used. At present, PVGCS larger than 50 megawatts in current net capacity use either c-Si or TF PV modules.

LCA analysis carried out for PV systems show that the PV modules contribute the most to the overall environmental impact. Among the common PV modules, the CdTe PV technology presents the best environmental performance whereas the m-Si PV module demonstrates the worst because of its high energy consumption during the solar cells' production process [14–16].

Despite the interest in considering environmental impact at the early design stage of a PVGCS, the majority of the reported works can be grouped into two categories, those considering the technical feasibility and/or economic concerns [17–21], and those relative to environmental assessment [22–24].

The main objective of this paper is to develop a methodology that includes environmental assessment in the early stages of the design and sizing of a PVGCS and takes the techno-economic aspects into account.

Methods and tools

Methodological framework

In any PV system, sizing represents an important part. Sizing of a PV system means determining how much energy is required and how many PV modules are needed to generate it. The design model which evaluates the techno-economic and environmental criteria simultaneously presented in detail in a previous work [25] was built in an open manner in order to interface easily with an external optimization loop. Fig. 1 shows the extended flow diagram of the methodology proposed for optimizing a PVGCS, taking into account both the Multi-Objective Optimization framework and the reduction of objectives via Principal Component Analysis (PCA).

The developed system is a simulation tool coupled with an optimization module for optimal configuration alternatives combining a Multi-Objective Optimization method, PCA and Multiple Criteria

Decision Making (MCDM) tools.

Solar irradiance estimation and mathematical sizing model

The first three models of the methodological framework are in charge of:

- estimating solar radiation received by the system according to the geographic location (see Perez-Gallardo et al. [25] for more details of this model);
- sizing the PVGCS based on a mathematical model that provides the annual energy generated from the characteristics of the system components and limitations on the design of the installation; and,
- evaluating the economic, technical and environmental criteria.

The multi-objective problem formulated for the ecodesign of PVGCS considers as techno-economic objectives the *output energy* (Q_{out}), the *Investment Payback Time* (*PBT*) and the *Energy Payback Time* (*EPBT*).

The losses inherent in any energy conversion have a variety of origins, e.g. shading between PV modules, the efficiency of elements, and array mismatch losses. So, Q_{out} can be expressed as:

$$Q_{out} = Q_{MAX} - (Loss_{PV\eta} + Loss_{DC/AC\eta} + Loss_{Shading} + Loss_{Mismatch}) \quad (1)$$

where Q_{MAX} is the maximum incident energy that the facility can receive. $Loss_{PV\eta}$, $Loss_{DC/AC\eta}$, $Loss_{Shading}$ and $Loss_{Mismatch}$ represent the number of energy losses due to the four most important causes (module efficiency, inverter efficiency, shading, and mismatch).

PBT refers to the estimation of the time to recover the initial investment is necessary for an investor:

$$PBT = \frac{\text{Initial investment}}{\text{Annual cash inflows}} \quad (2)$$

The initial investment of the project considers the purchasing cost of all the components that make up the installation (PV modules, cables, mounting system, etc.), the construction and the edification cost as well as the cost of connection to the grid. The annualized cash flow represents the income derived from selling all the energy production.

EPBT is the period needed by the renewable energy system to generate the same amount of energy (in terms of primary energy equivalent) as the amount that is consumed in its whole life cycle [26]. To convert annual power generation (kWh) of electricity to primary energy, the efficiency of power plants in the country under consideration is taken into account [27].

$$EPBT = \frac{\text{Primary energy required for manufacturing}}{\text{Annual primary energy produced}} \quad (3)$$

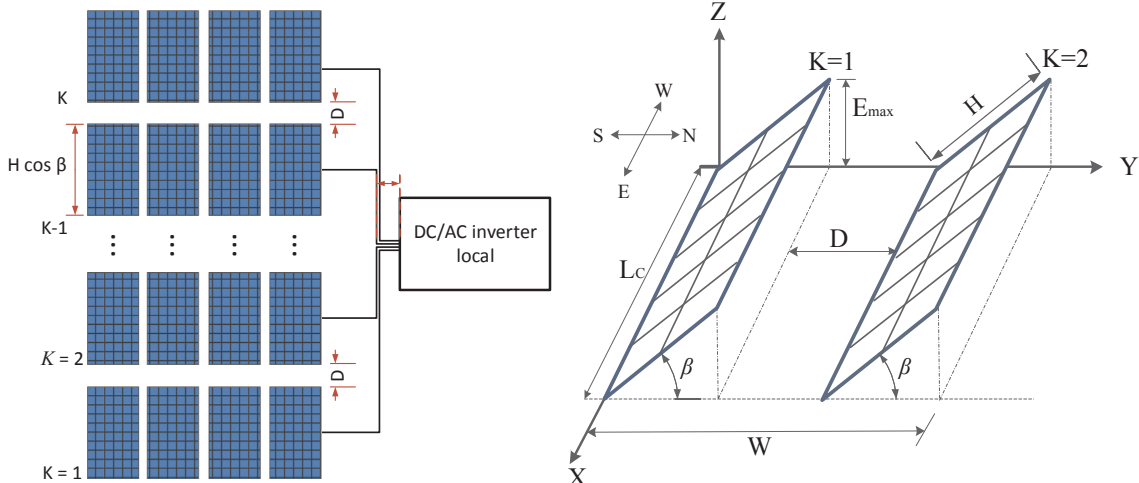

Fig. 2. Stationary solar collector field design used to formulate the multi-objective problem.

The environmental assessment was performed following the guidelines given by the LCA methodology [26] using the software tool SimaPro 7.3. To evaluate different PV technologies, the number of panels required to meet a given amount of energy is considered. The minimum number of panels required to meet a demand of 1 kWh with an average daily irradiance of 1 kWh/m² is computed. The functional unit is the demand of 1 kWh.

The system boundaries were the same as in Perez-Gallardo et al. [25]. The boundary includes the extraction of materials to the design of PV module. The recycling processes of the different components of PVGS are not included in this study due to lack of reliable information for all PV modules technologies evaluated. A 20-year operation period for the PVGS was selected. The 15 IMPACT 2002+ environmental midpoint categories [28] are used: Aquatic Acidification (AA), Aquatic Ecotoxicity (AE), Aquatic Eutrophication (AEU), Carcinogen (C), Global Warming (GW), Ionizing Radiation (IR), Land Occupation (LO), Mineral Extraction (ME), Non-Carcinogen (NC), Non-Renewable energy (NR), Ozone Layer Depletion (OLD), Respiratory Inorganic (RI), Respiratory Organic (RO), Terrestrial Acidification/Nitrification (TAN) and Terrestrial Ecotoxicity (TE).

The multi-objective problem has 18 objectives (Eq. (4)). The constraints represent the reliability and maintenance aspects as well as requirements related to the available area considered by Weinstock and Appelbaum [29]. The model considers a horizontal field without elevation, with a fixed length L and a fixed width W . It comprises K rows of solar collectors with a horizontal distance D between rows. Each collector has a length L_C , a height H , and is tilted at an angle β with respect to the horizontal. Each collector is an array of PV modules arranged in N_r rows and N_c columns. Fig. 2 shows the schematic representation of PVGS with the parameters considered in Eq. (4).

Minimize $\{-Q_{out}, PBT, EPBT, AA, AE, AEU, C, GW, IR, LO, ME, NC, NR, OLD, RI, RO, TAN, TE\}$

Subject to:

$$\begin{aligned} KH \cos \beta + (K-1)D &\leq W \\ D &\geq D_{\min} \\ H \sin \beta &\leq E_{\max} \\ H &\leq H_{\max} \\ 0^\circ &\leq \beta \leq 90^\circ \\ 2 &\leq K \in \mathbb{Z}^+ \end{aligned} \quad (4)$$

Multi-objective Genetic Algorithm

In many real-life problems, the objectives under consideration conflict with each other. A reasonable solution is to investigate a set of alternatives that satisfies the objectives at an acceptable level without being dominated by any other solution. Genetic Algorithms (GA) are well suited to solve Multi-Objective Optimization problems [30,31]. The ability of GA to simultaneously search different regions of a solution space makes it possible to find a diverse set of non-dominated solutions for difficult problems.

When moving from one Pareto optimal solution to another one, there is always a certain amount of sacrifice of one objective to achieve a certain amount of gain in another. For a given Pareto optimal set of solutions, the corresponding objective function values in the objective space are called the Pareto front. The ultimate goal of a Multi-Objective Optimization algorithm is to identify solutions in the Pareto optimal set. The MULTIGEN environment previously developed by our research group [32] was chosen as the Genetic Algorithm platform. A variant of NSGA-II developed for mixed problems and implemented in the MULTIGEN environment was selected.

Multiple-criteria decision-making

To select the alternative that represents the best trade-off among those of the Pareto front, an MCDM has proved to be a solution in

engineering applications. MCDM methods deal with the process of making decisions in the presence of multiple objectives. The objectives are usually conflicting and, therefore, the solution is highly dependent on the preferences of the decision-maker and must be a compromise. Environmental applications of MCDM are reviewed in [33,34]. Among those considered, TOPSIS (Technique for Order Preference by Similarity to the Ideal Solution) is attractive because it requires only subjective input from decision makers, via the assignment of a weight to each objective, which makes it popular in engineering applications and Ecodesign processes [35–37]. The basic idea of TOPSIS method is to choose a solution that is closest to the ideal solution (better on all criteria) and furthest away from the worst (which degrades all criteria). M-TOPSIS [38], a variant of TOPSIS, was adopted in this work. The steps of the M-TOPSIS procedure are listed below.

Step 1: Build the decision matrix. Establish a matrix which shows m alternatives evaluated by the n criteria chosen. Usually, the cost criteria are transformed into benefit criteria by the reciprocal ratio method as it shown in Eq. (5) [38].

$$X'_{ij} = 1/X_{ij} \quad (5)$$

In where X_{ij} represents the value of alternative i into the criterion j .

Step 2: Calculate the normalized decision matrix A . The values in the decision matrix X are transformed into normalized, non-dimensional values in order to convert the original values within the interval $[0,1]$ as follows:

$$A = [a_{ij}], \quad a_{ij} = X'_{ij} / \sqrt{\sum_{i=1}^n (X'_{ij})^2} \quad (6)$$

where a_{ij} stands for the normalized value; $i = 1, 2, \dots, m$; $j = 1, 2, \dots, n$

Step 3: Coefficient vector of the importance of each criterion. Assign weights of importance to a criterion relative to others. The weighted normalized matrix V is calculated by:

$$V = [v_{ij}], \quad v_{ij} = w_j a_{ij} \quad (7)$$

where w_j stands for the weight of the individual criterion j ; $i = 1, 2, \dots, m$; $j = 1, 2, \dots, n$.

Step 4: Determine the positive ideal (A^+) and negative ideal (A^-) solution from the matrix A :

$$A^+ = \{v_1^+, v_2^+, \dots, v_n^+\}, \quad v_j^+ = \{\max_i(v_{ij}), j \in J^+; \min_i(v_{ij}), j \in J^-\} \quad (8)$$

$$A^- = \{v_1^-, v_2^-, \dots, v_n^-\}, \quad v_j^- = \{\min_i(v_{ij}), j \in J^+; \max_i(v_{ij}), j \in J^-\} \quad (9)$$

where $J^+ = \{i = 1, 2, \dots, m\}$ when i is associated with benefit criteria; $J^- = \{i = 1, 2, \dots, m\}$ when i is associated with cost criteria. $j = 1, 2, \dots, n$.

Step 5: Calculate Euclidean distance:

$$D_i^+ = \sqrt{\sum_{j=1}^n (v_j^+ - v_{ij})^2} \quad (10)$$

$$D_i^- = \sqrt{\sum_{j=1}^n (v_j^- - v_{ij})^2} \quad (11)$$

for $i = 1, 2, \dots, m$.

Step 6: Calculate the relative closeness to the ideal solution, i.e. the distance between the ideal criteria set values (A^+) and non-ideal criteria set values (A^-). The ratio value of R_i is calculated as follows:

$$R_i = \sqrt{(D_i^+ - \min(D^+))^2 + (D_i^- - \max(D^-))^2} \quad (12)$$

where $i = 1, 2, \dots, m$.

Step 7: Rank alternatives in increasing order according to the ratio value of R_i . The best alternative corresponds to the M-TOPSIS coefficient R_i nearest to 0.

Principal Component Analysis (PCA) for Multi-Objective Optimization

Sabio et al. [39] and Gutierrez et al. [40] have pointed out that some of the environmental midpoint categories considered for the environmental assessment may be correlated. Another problem is the difficulty of visualizing the solution space because of the dimensionality of the problem. Thus, a multivariate statistical procedure will be useful and must be applied to reduce the objectives.

PCA constitutes an interesting alternative to identify the relationships that may exist between some objectives in order to eliminate redundant environmental impacts [40,41]. This action will facilitate the visualization and interpretation of the solution space. PCA allows identifying the correlated variables with a view to reducing the dimensionality taking into as much variation of the data set as possible. The original variables are reduced into a smaller set of uncorrelated linear combination, known as principal components (PCs). PCs are ranked according to the amount of variance they explain. Following the guidelines proposed by Sabio et al. [39] and Deb and Saxena [42], the same set of heuristic rules will be used to reduce the dimensionality of the problem based on the eigenvectors of the correlation matrix.

Results and discussion

The proposed methodology was applied to the following case study. A photovoltaic grid-connected power plant is considered to be installed near the city of Toulouse, France (43.4° N, 1.2° E). It is assumed that the DC /AC inverter has a nominal power of 300 kW DC with an efficiency of 97.5% and a lifetime of 10 years. A 20-year lifetime is assumed for PV modules and other electrical components. The dimensions and characteristics of the five PV modules used are those presented by Perez-Gallardo et al. [25] (see Table S1).

The available area was W_{max} (150 m) \times L_{max} (100 m). The technical constraints indicated in the mathematical formulation were fixed: the minimum distance between each shed was $D_{min} = 1.00$ m; the dimensions of the PV collectors had to respect $H_{max} = 3.00$ m and $E_{max} = 4.00$ m and the minimum number of sheds (K) was 2. No mix of technologies was allowed. The percentage of loss caused by the array module wiring and mismatch was set at 5%. The panels are mounted on a fixed structure. Table S2 shows the characterization values to perform the environmental assessment for the elements considered.

According to the methodological framework of Fig. 1, a Multi-Objective Optimization taking 18 objectives into account was performed. Each optimization case was run three times to guarantee the stochastic nature of the algorithm with a population size of 200 individuals during 400 generations. The common parameters of the GA used were determined following the guidelines suggested by Gomez [32]: a crossover rate of 90% and a mutation rate of 50%.

The selection of the best configuration of the PV grid-connected power plant involved a two-step application of the M-TOPSIS method: first, the best alternative in each of the five technologies was chosen (M-TOPSIS application 1); then, from these results, the best configuration was selected (M-TOPSIS application 2). The weight allocated to each objective under study was: 1 for Q_{outs} , PBT , and $EPBT$, and 1/15 for each of the environmental categories.

The best trade-off was found when a-Si modules were used, while c-Si technologies gave the worst compromise (See Table S3).

In order to decrease dimensionality and complexity in terms of calculation as well as to facilitate the analysis of the resulting Pareto-

optimal front, PCA was applied to the Pareto optimal set of the original problem. The results of the 15 environmental categories were standardized by subtracting the average of each column from each data point in the matrix so that PCA could work properly. Following the PCA guidelines described, the correlation matrix was generated (see Table S4). From Table S4, high correlation values between many of the categories can be observed. The *princom* function integrated into the Statics toolbox of MATLAB was used to generate the eigenvalues (see the first 10 of 15 eigenvalues in Table 1) and eigenvector matrix (see Table S5).

As it was mentioned above, PCA permits to explain the variance structure of a set of variables through a few linear combination (PC) of them in order to reduce the original data set and identify the relation that exists between the variables. Each PC corresponds to a percentage of the total variance among the variables and is ranked according to this percentage from the maximum to the minimum. In Table 1, PC_1 represents the linear combination that explains the maximum variance (79.85%), while the last four PCs (PC_7 – PC_{10}) contribute to less than 0.1%, i.e. the first six of 15 PCs represent almost 100% of the total variance among the data set. The next step is to define the number of PCs retained.

Applying the Kaiser-Guttman rule ($\lambda_e > 1$), only the first two principal components (PC_1 , PC_2) were kept for further analysis. A threshold cut-off value (CUT) adopted by Deb and Saxena [42] was considered for the second reduction. As the cumulative variance of the two remaining principal components (0.9144) was lower than the defined CUT (0.95), PC_1 and PC_2 were finally selected. The first and second columns in the eigenvector matrix give the weight used in the linear combination of the 15 environmental categories data in PC_1 and PC_2 respectively. The values of the eigenvector of PC_1 and PC_2 could be represented by a bi-dimensional plot in order to identify the relations between the 15 environmental categories.

Fig. 3a shows the corresponding screen plot while the bi-dimensional plot representing the component loadings of the environmental objectives projected onto the sub-spaces of the first two principal components is illustrated in Fig. 3b. As observed, the two-dimensional plot and the correlation matrix (Table S4) suggests that NC , IO , AE , TE , TAN , AA , AEU , LO , GW , NR , RI categories have a high correlation. Similarly, a high correlation exists between the OLD - RO and ME - C categories. The heuristic rules determine that only three environmental indicators (RI , OLD , ME) must be kept for further analysis. RI is replaced by GW (expressed in kg CO₂ equivalent). GW is, in fact, a significant indicator when energy systems are involved. A very slight difference between the values of the eigenvector PC_1 for RI and GW supports our decision.

Following the methodology proposed, a new set of optimizations was then carried out with only six objective functions: Q_{out} – PBT – $EPBT$ – GW – OLD – ME . M-TOPSIS was applied to select the best trade-off among the alternatives generated. A weight of 1 was allocated to Q_{out} , PBT and $EPBT$, and 1/3 to GW , ME and OLD . Table 2 shows the values of the six objectives function and the final ranking of the five PV module configurations.

The final ranking identifies the CdTe-based PV module configuration as the best option because it leads 3 of the 6 objectives under evaluation. It differs from the original ranking even though c-Si technologies continue having the worst compromise. PCA is then applied once more to the six remaining objectives in order to find a possible

Table 1
Eigenvalues for the 15 environmental categories.

	PC_1	PC_2	PC_3	PC_4	PC_5	PC_6	PC_7	PC_8	PC_9	PC_{10}
Eigenvalue (λ_e)	11.978	1.746	0.678	0.320	0.169	0.097	0.013	0.000	0.000	0.000
Variability (%)	79.852	11.637	4.520	2.130	1.124	0.647	0.088	0.001	0.000	0.000
Cumulative % (G_j)	79.852	91.490	96.010	98.140	99.265	99.911	99.999	100.00	100.00	100.00

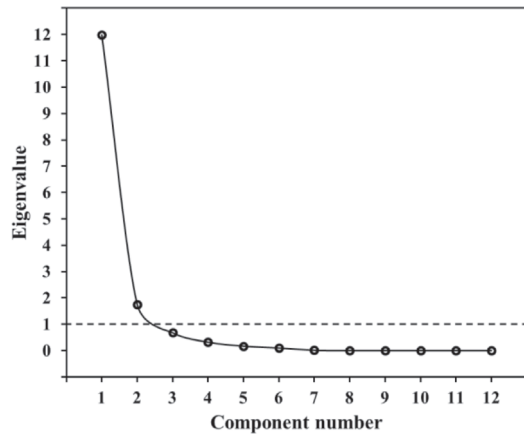

a) Screen Plot

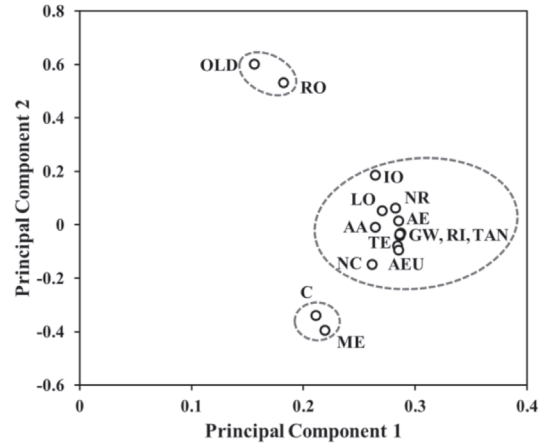

b) Bi-dimensional plot

Fig. 3. PCA for the 15 environmental categories.

influence of the other criteria to the final ranking and to continue reducing the complexity of the problem and the computational cost. The correlation matrix (Table S6), the eigenvalues (Table 3) and the eigenvectors matrix (Table S5) were generated according to PCA guidelines.

The results show that (*EPBT – PBT*) on the one hand and (*ME – GW*) on the other hand were correlated (see Fig. 4). This analysis led us to reject 2 objectives (*EPBT* and *ME*). A new multi-objective process was then conducted with only *PBT*, *GW*, *OLD* and *Q_{out}*. Table 4 shows the values of the objectives corresponding to the five configurations chosen by M-TOPSIS. The weighting for *Q_{out}* and *PBT* was equal to 1 and 0.5 for *GW* and *OLD*. The final ranking suggests that the best option is the a-Si-based configuration. By comparing the ranking of the five PV technologies selected according to the three multi-objective cases treated in this work (Table 5), it can be observed, on the one hand, that both a-Si and CdTe PV modules achieve a better compromise regardless of the number of objectives under study. On the other hand, c-Si PV technologies have the lowest rank in all the three cases. Even if the c-Si PV technologies are the most energy efficient options and have the lowest *PBT*, they are the least environmentally friendly.

It can be highlighted that the final ranking of the last case with 4 objectives is quite similar to the first case treated. The position between the c-Si technologies is the only difference. The main reason is probably the precision used to calculate the value of the M-TOPSIS score for establishing the final ranking. It can be concluded that only four objectives (2 techno-economic: *Q_{out}* and *PBT*; and 2 environmental: *GW* and *OLD*) are sufficient to size a PVGCS taking into account the 3 criteria simultaneously.

Recent advances in the efficiency conversion of the PV modules technologies, the commercialization of the next generation PV modules as well as the variation in the price of the components of a PVGCS may affect the ranking.

In order to assess in more detail the results obtained and to understand why PV modules based on c-Si have the worst environmental impacts, the manufacturing processes for the five PV technologies have

Table 2

Values of the six objectives and PV technologies ranking after applying M-TOPSIS.

PV Techno	<i>Q_{out}</i> (MW h)	<i>PBT</i> (year)	<i>EPBT</i> (year)	<i>GW</i> (kg CO ₂ eq)	<i>OLD</i> (CFC-11 eq)	<i>ME</i> (MJ)	Rank
m-Si	2,250.96	8.50	1.73	2,343,221	0.43	77,316.43	4
p-Si	1,615.37	10.34	1.90	1,983,472	0.41	69,675.70	5
a-Si	947.38	10.59	1.78	1,272,499	0.04	132,210.36	2
CdTe	1,384.24	10.49	1.31	1,429,545	0.06	48,175.48	1
CIS	1,524.48	9.29	1.72	1,778,691	0.08	124,433.07	3

Table 3

Eigenvalues for the 6 remaining objectives.

	PC ₁	PC ₂	PC ₃	PC ₄	PC ₅	PC ₆
Eigenvalue (λ_i)	3.252	1.023	0.904	0.751	0.070	0.000
Variability (%)	54.203	17.046	15.063	12.520	1.168	0.000
Cumulative % (G_j)	54.203	71.249	86.312	98.832	100.00	100.00

been studied. Figure FS1 (see supporting information), describes the process flows for each PV technology under study. Three main steps can be identified: (1) *production and preparation of raw materials*, (2) *solar cell/thin film manufacturing* and (3) *PV module assembly*. First, *GW* category has been considered since this impact is strongly linked to the supply of energy coming from fossil fuels. The energy mix used has a large influence on climate change. Fig. 5 shows the contribution of each of the three steps to the total value of the *GW* category for each PV technology. Even though the first step (*production and preparation of raw material*) has the highest contribution in all PV technologies, the c-Si contribution is the most significant one.

Furthermore, for c-Si technology, the *production and preparation of raw material* step can be divided into two sub-steps. The first sub-step involves the environmental impact related to the activities leading to solar-grade silicon (SoG-Si), while the second one considers the environmental impact generated by the activities which produce the silicon ingot and silicon wafers. The results of this analysis are presented in Fig. 6.

The highest contribution is found at *silicon ingot/wafer* production. Looking at the process followed to form the wafer, the high energy demand to achieve the formation of the ingot is the main cause. In the case of m-Si, the energy requirements are still greater due to high energy consumption involved during CZ crystal growth to obtain a regular, perfectly-ordered crystal structure.

It is important to mention that the decommissioning and recycling of PV modules were not taken into account since data on the environmental impacts associated with these end-of-life steps are relatively

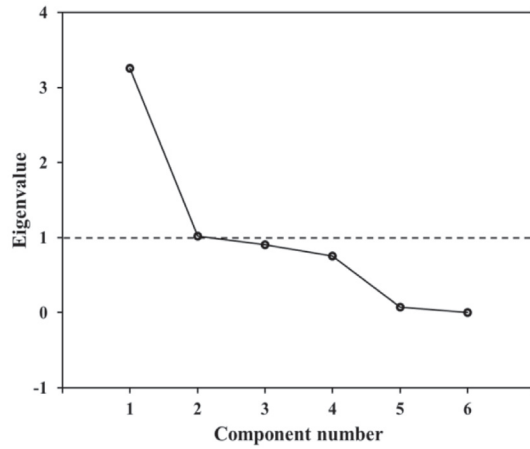

a) Scree Plot

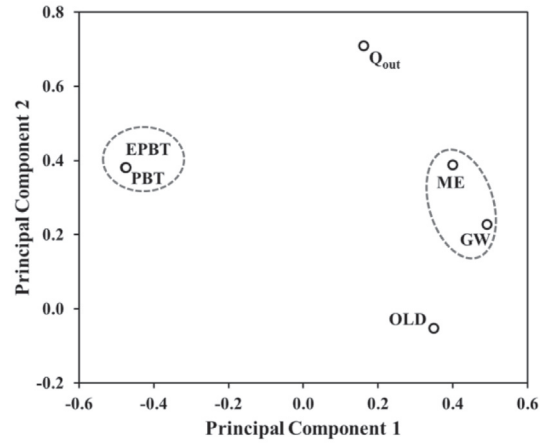

b) Bi-dimensional plot

Fig. 4. PCA for the 6 remaining categories: Output energy (Q_{out}), Investment Payback Time (PBT), Energy Payback Time ($EPBT$), Global Warming (GW), and Ozone Layer Depletion (OLD).

Table 4

Values of the six objectives and PV technologies ranking after applying M-TOPSIS.

PV Techno	Q_{out} (MW h)	PBT (year)	GW (kg CO ₂ eq)	OLD (kg CFC-11 eq)	Rank
m-Si	2,323.27	8.46	2,420,954	0.44	4
p-Si	1,668.83	10.28	2,051,091	0.42	5
a-Si	945.45	10.59	1,271,289	0.04	1
CdTe	1,483.10	10.40	1,532,570	0.06	2
CIS	1,625.54	9.20	1,903,321	0.09	3

Table 5

Ranking position of the 5 PV modules technologies at the three cases.

PV Techno	18 objectives ranking	6 objectives ranking	4 objective ranking
m-Si	5	4	4
p-Si	4	5	5
a-Si	1	2	1
CdTe	2	1	2
CIS	3	3	3

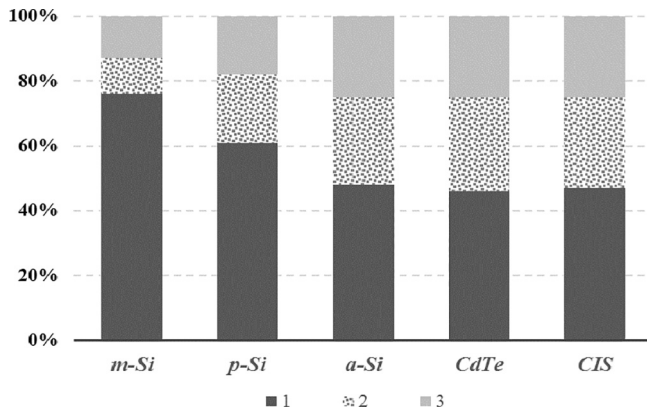

Fig. 5. Contribution of the three main steps of PV manufacturing process to GW category score for each PV technology under study (1) *production and preparation of raw materials*, (2) *solar cell/thin film manufacturing* and (3) *PV module assembly*.

scarce and are not yet included in the classical LCA database. We are aware, however, that the recycling process may also change the final classification because some PV module technologies contain hazardous

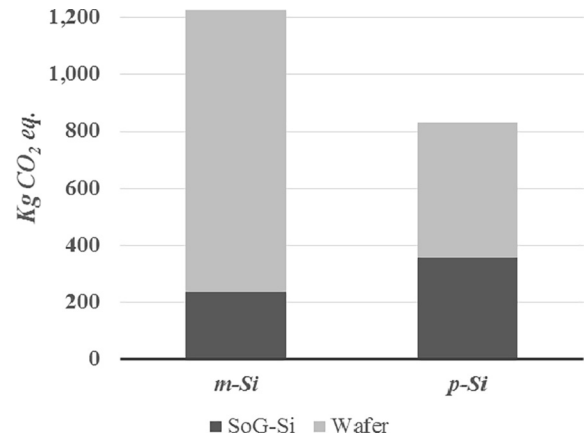

Fig. 6. Environmental contribution of the two sub-steps to *production and preparation of raw material* step for c-Si-based PV technology.

materials such as cadmium, tellurium, lead and selenium. For example, cadmium compounds are currently regulated in many countries because of their toxicity to fish and wildlife. Cadmium has also been associated with numerous human illnesses [43,44].

Conclusion

An ecodesign framework that considers simultaneously several technical, economic and life cycle environmental criteria was developed and tested through a case study. Different optimization cases have been investigated to evaluate the developed approach for sizing PV systems. Redundant environmental objectives were identified and grouped through PCA on a post analysis keeping only four objectives (Q_{out} , PBT , GW , and OLD). An MCDM tool based on M-TOPSIS allowed to select the alternative that provides a better compromise among all the objective functions that have been investigated.

The results presented in this paper highlight the advantage of second-generation PV modules (thin film) over c-Si-based PV modules. While the latter have better performance in energy generation, the environmental aspect is what makes them fall to the last positions. The recycling process of PV modules constitutes an important issue that must affect the final ranking.

Even though the mathematical design model used has its own limitations and assumptions for PVGCS sizing problems, it is enough flexible to fit new conditions, for instance to size PVGCS mounted on

single or double tracking system.

The methodology developed in this work can be useful for PVGCS designers to find the optimal configuration among a list of commercially available system devices, in such a way that the total benefit achieved during the system operational lifetime period is maximized with the lowest environmental impact. Likewise, it is a decision support tool for implementing strategies of renewable energy generation that can be considered as truly green.

This framework integrating Multi-Objective Optimization, PCA and MCDM can be useful for applying ecodesign policies to other renewable energy generation technologies.

Appendix A. Supplementary data

More information relative to the features of PV modules considering the environmental assessment as well as the correlation and eigenvectors matrix (Tables S1 – S7) can be found in Supporting information file

Supplementary data associated with this article can be found, in the online version, at <http://dx.doi.org/10.1016/j.seta.2018.03.008>.

References

- [1] EPIA. Solar photovoltaic on the road to large scale grid integration. Belgium; 2012.
- [2] Fthenakis VM, Kim HC, Alsema E. Emissions from photovoltaic life cycles. *Environ Sci Technol* 2008;42:2168–74.
- [3] de Wild-Scholten MJ, Alsema E. Towards cleaner Solar PV. *Refocus* 2004;46–9.
- [4] ISO/TR 14062. Environmental management, integrating environmental aspects into product design and development. Geneva, Switzerland; 2002.
- [5] Karlsson R, Luttrupp C. EcoDesign: what's happening? An overview of the subject area of EcoDesign and of the papers in this special issue. *J Clean Prod* 2006;14:1291–8. <http://dx.doi.org/10.1016/j.jclepro.2005.11.010>.
- [6] Borchardt M, Wendt MH, Pereira GM, Sellitto MA. Redesign of a component based on ecodesign practices: environmental impact and cost reduction achievements. *J Clean Prod* 2011;19:49–57. <http://dx.doi.org/10.1016/j.jclepro.2010.08.006>.
- [7] Fargnoli M, Kimura F. Sustainable Design of Modern Industrial Products. *Proc. LCE 2006 2006*;14062:189–94. Leuven, Belgium.
- [8] Sadler B, Verheem R. Strategic Environmental Assessment. Status, challenges and future directions. The Hague; 1996.
- [9] Linkov I, Seager TP. Coupling multi-criteria decision analysis, life-cycle assessment, and risk assessment for emerging threats. *Environ Sci Technol* 2011;45:5068–74. <http://dx.doi.org/10.1021/es100959q>.
- [10] Cowell SJ, Fairman R, Lofstedt RE. Use of Risk Assessment and Life Cycle Assessment in Decision Making: A Common Policy Research Agenda. *Risk Anal* 2002;22:879–94. <http://dx.doi.org/10.1111/1539-6924.00258>.
- [11] Heijungs R, Huppes G, Zamagni A, Masoni P. Life Cycle Assessment: Past, Present, and Future. *Environ Sci Technol* 2011;45:90–6.
- [12] Finnveden G, Hauschild MZ, Ekvall T, Guinée J, Heijungs R, Hellweg S, et al. Recent developments in Life Cycle Assessment. *J Environ Manage* 2009;91:1–21. <http://dx.doi.org/10.1016/j.jenvman.2009.06.018>.
- [13] Green MA, Emery K, Hishikawa Y, Warta W, Dunlop ED. Solar cell efficiency tables (version 43). *Prog Photovoltaics Res Appl* 2014;22:1–9. <http://dx.doi.org/10.1002/ppp.2452>.
- [14] Fthenakis VM, Kim HC. Photovoltaics: Life-cycle analyses. *Sol Energy* 2011;85:1609–28. <http://dx.doi.org/10.1016/j.solener.2009.10.002>.
- [15] Peng J, Lu L, Yang H. Review on life cycle assessment of energy payback and greenhouse gas emission of solar photovoltaic systems. *Renew Sustain Energy Rev* 2013;19:255–74. <http://dx.doi.org/10.1016/j.rser.2012.11.035>.
- [16] Sherwani AF, Usmani JA. Life cycle assessment of solar PV based electricity generation systems: A review. *Renew Sustain Energy Rev* 2010;14:540–4. <http://dx.doi.org/10.1016/j.rser.2009.08.003>.
- [17] Notton G, Lazarov V, Stoyanov L. Optimal sizing of a grid-connected PV system for various PV module technologies and inclinations, inverter efficiency characteristics and locations. *Renew Energy* 2010;35:541–54. <http://dx.doi.org/10.1016/j.renene.2009.07.013>.
- [18] Kazem HA, Khatib T. Techno-economical assessment of grid connected photovoltaic power systems productivity in Sohar, Oman. *Sustain Energy Technol Assess* 2013;3:61–5. <http://dx.doi.org/10.1016/j.seta.2013.06.002>.
- [19] Paudel AM, Sarper H. Economic analysis of a grid-connected commercial photovoltaic system at Colorado State University-Pueblo. *Energy* 2013;52:289–96. <http://dx.doi.org/10.1016/j.energy.2013.01.052>.
- [20] Bakhshi R, Sadeh J, Mosaddegh H. Optimal economic designing of grid-connected photovoltaic systems with multiple inverters using linear and nonlinear module models based on Genetic Algorithm. *Renew Energy* 2014;72:386–94. <http://dx.doi.org/10.1016/j.renene.2014.07.035>.
- [21] Wissem Z, Gueorgui K, Hédi K. Modeling and technical–economic optimization of an autonomous photovoltaic system. *Energy* 2012;37:263–72. <http://dx.doi.org/10.1016/j.energy.2011.11.036>.
- [22] Menoufi K, Chemisana D, Rosell JI. Life Cycle Assessment of a Building Integrated Concentrated Photovoltaic scheme. *Appl Energy* 2013;111:505–14. <http://dx.doi.org/10.1016/j.apenergy.2013.05.037>.
- [23] Desideri U, Proietti S, Zepparelli F, Sdringola P, Bini S. Life Cycle Assessment of a ground-mounted 1778kWp photovoltaic plant and comparison with traditional energy production systems. *Appl Energy* 2012;97:930–43. <http://dx.doi.org/10.1016/j.apenergy.2012.01.055>.
- [24] Ito M, Komoto K, Kurokawa K. Life-cycle analyses of very-large scale PV systems using six types of PV modules. *Curr Appl Phys* 2010;10:S271–3. <http://dx.doi.org/10.1016/j.cap.2009.11.028>.
- [25] Perez-Gallardo JR, Azzaro-Pantel C, Astier S, Domenech S, Aguilar-Lasserre A. Ecodesign of photovoltaic grid-connected systems. *Renew Energy* 2014;64:82–97. <http://dx.doi.org/10.1016/j.renene.2013.10.027>.
- [26] Fthenakis V, Frischknecht R, Rauei M, Kim HC, Alsema E, Held M, et al. Methodology guidelines on life cycle assessment of photovoltaic electricity; 2011.
- [27] Bhat IK, Prakash R. LCA of renewable energy for electricity generation systems—A review. *Renew Sustain Energy Rev* 2009;13:1067–73. <http://dx.doi.org/10.1016/j.rser.2008.08.004>.
- [28] Jolliet O, Margni M, Charles R. IMPACT 2002 + : A new life cycle impact assessment methodology. *Int J LCA* 2003;8:324–30.
- [29] Weinstock D, Appelbaum J. Optimization of Solar Photovoltaic Fields. *J Sol Energy Eng* 2009;131:31003. <http://dx.doi.org/10.1115/1.13142705>.
- [30] Coello Coello CA, Becerra RL. Evolutionary Multi-Objective Optimization in Materials Science and Engineering. *Mater Manuf Process* 2009;24:119–29.
- [31] Papandreou V, Shang Z. A multi-criteria optimisation approach for the design of sustainable utility systems. *Comput Chem Eng* 2008;32:1589–602. <http://dx.doi.org/10.1016/j.compchemeng.2007.08.006>.
- [32] Gomez A, Pibouleau L, Azzaro-Pantel C, Domenech S, Latgé C, Haubensack D. Multiobjective genetic algorithm strategies for electricity production from generation IV nuclear technology. *Energy Convers Manag* 2010;51:859–71. <http://dx.doi.org/10.1016/j.enconman.2009.11.022>.
- [33] Huang IB, Keisler J, Linkov I. Multi-criteria decision analysis in environmental sciences: ten years of applications and trends. *Sci Total Environ* 2011;409:3578–94. <http://dx.doi.org/10.1016/j.scitotenv.2011.06.022>.
- [34] Huang YP, Poh KL, B.W. A. Decision analysis in energy and environmental modeling. *Energy* 1995;20:843–55.
- [35] Boix M, Montastruc L, Pibouleau L, Azzaro-Pantel C, Domenech S. A multiobjective optimization framework for multicontaminant industrial water network design. *J Environ Manage* 2011;92:1802–8. <http://dx.doi.org/10.1016/j.jenvman.2011.02.016>.
- [36] Morales Mendoza LF, Perez Escobedo JL, Azzaro-Pantel C, Pibouleau L, Domenech S, Aguilar-Lasserre A. Selecting the best portfolio alternative from a hybrid multi-objective GA-MCDM approach for New Product Development in the pharmaceutical industry. 2011 IEEE Symp. Comput. Intell. Multicriteria Decis., IEEE 2011;2011:159–66. <http://dx.doi.org/10.1109/SMDCM.2011.5949271>.
- [37] Ahmadi MH, Dehghani S, Mohammadi AH, Feidit M, Barranco-Jimenez MA. Optimal design of a solar driven heat engine based on thermal and thermo-economic criteria. *Energy Convers Manag* 2013;75:635–42. <http://dx.doi.org/10.1016/j.enconman.2013.07.078>.
- [38] Ren L, Zhang Y, Wang Y, Sun Z. Comparative analysis of a NovelM-TOPSISMethod and TOPSIS. *Appl Math Res eXpress* 2007;2007. <http://dx.doi.org/10.1093/amrx/abm005>. 10 pages.
- [39] Sabio N, Kostin A, Guillén-Gosálbez G, Jiménez L. Holistic minimization of the life cycle environmental impact of hydrogen infrastructures using multi-objective optimization and principal component analysis. *Int J Hydrogen Energy* 2012;37:5385–405. <http://dx.doi.org/10.1016/j.ijhydene.2011.09.039>.
- [40] Gutiérrez E, Lozano S, Adenso-Díaz B. Dimensionality Reduction and Visualization of the Environmental Impacts of Domestic Appliances. *J Ind Ecol* 2010;14:878–89. <http://dx.doi.org/10.1111/j.1530-9290.2010.00291.x>.
- [41] Pozo C, Ruíz-Femenia R, Caballero J, Guillén-Gosálbez G, Jiménez L. On the use of Principal Component Analysis for reducing the number of environmental objectives in multi-objective optimization: Application to the design of chemical supply chains. *Chem Eng Sci* 2012;69:146–58. <http://dx.doi.org/10.1016/j.ces.2011.10.018>.
- [42] Deb K, Saxena DK. On finding pareto-optimal solutions through dimensionality reduction for certain large-dimensional multi-objective optimization problems emfo for many objectives; 2005.
- [43] Fthenakis VM. Life cycle impact analysis of cadmium in CdTe PV production. *Renew Sustain Energy Rev* 2004;8:303–34. <http://dx.doi.org/10.1016/j.rser.2003.12.001>.
- [44] Bernard A. Cadmium and its adverse effects on human health. *Indian J Med Res* 2008;128:557–64.