



**HAL**  
open science

## Plasma equilibrium reconstruction of jet discharges using the imas modelling infrastructure

R. Coelho, Zwingmann W., Blaise Faugeras, E. Giovannozzi, P. Mccarthy, E.  
P. Suchkov, F.S. Zaitsev, J. Hollocombe, N. Hawkes, G. Szepesi, et al.

► **To cite this version:**

R. Coelho, Zwingmann W., Blaise Faugeras, E. Giovannozzi, P. Mccarthy, et al.. Plasma equilibrium reconstruction of jet discharges using the imas modelling infrastructure. 27th IAEA Fusion Energy Conference FEC 2018, Oct 2018, Gandhinagar, India. hal-01947230

**HAL Id: hal-01947230**

**<https://hal.science/hal-01947230>**

Submitted on 6 Dec 2018

**HAL** is a multi-disciplinary open access archive for the deposit and dissemination of scientific research documents, whether they are published or not. The documents may come from teaching and research institutions in France or abroad, or from public or private research centers.

L'archive ouverte pluridisciplinaire **HAL**, est destinée au dépôt et à la diffusion de documents scientifiques de niveau recherche, publiés ou non, émanant des établissements d'enseignement et de recherche français ou étrangers, des laboratoires publics ou privés.

# PLASMA EQUILIBRIUM RECONSTRUCTION OF JET DISCHARGES USING THE IMAS MODELLING INFRASTRUCTURE

R. COELHO

Instituto de Plasmas e Fusão Nuclear, Instituto Superior Técnico, Universidade de Lisboa  
Lisboa, Portugal  
Email: rcoelho@ipfn.tecnico.ulisboa.pt

W. ZWINGMANN

Instituto de Plasmas e Fusão Nuclear, Instituto Superior Técnico, Universidade de Lisboa  
Lisboa, Portugal

B. FAUGERAS

CNRS Laboratoire J.A.Dieudonné, Université de Nice-Sophia-Antipolis  
Nice, France

E. GIOVANNOZZI

ENEA for EUROfusion  
Frascati (Roma), Italy

P. MCCARTHY

Department of Physics, University College Cork  
Cork, Ireland

E.P. SUCHKOV, F.S. ZAITSEV

Comenius University, EUROfusion CU Slovakia  
NIISI, Russian Federation

J. HOLLOCOMBE, N. HAWKES, G. SZEPESI, L. APPEL, S. SILBURN

Culham Centre for Fusion Energy, Culham Science Centre  
Abingdon, Oxfordshire, UK

G. POULIPOULIS

Section of Astrophysics, Physics Department, University of Ioannina  
Ioannina, Greece

D TERRANOVA

Consorzio RFX  
Padova, Italy

and JET contributors\* and EUROfusion-IM Team

## Abstract

The reconstruction of Tokamak plasma equilibrium is a fundamental step in the understanding of fusion plasma physics since it sets the starting point for all subsequent plasma modelling applications and experimental data interpretation. The verification and validation of the numerical codes used to reconstruct plasma equilibrium, using as many available input experimental data e.g. magnetic field or flux measurements, density and temperature diagnostics and polarimetry diagnostics, is essential both for physics model interpretation and when qualifying and extrapolating for ITER. In the framework of the EUROfusion Work Package on Code Development for Integrated Modelling, a scientific Kepler workflow for the reconstruction of Tokamak plasma equilibrium was prototyped, using the ITER Integrated Modelling and Analysis Suite (IMAS). The workflow can seamlessly use any sort of data from Tokamak experiments and call equilibrium reconstruction codes such as EQUAL, EQUINOX, NICE, EFIT++ and SDSS, all using the same physics and engineering data ontology and methods for accessing the data. In the paper, plasma equilibrium reconstructions on dedicated JET plasma

---

\*See the author list of X. Litaudon et al 2017 Nucl. Fusion 57 102001

· See <http://www.euro-fusionscipub.org/eu-im>

discharges are shown using at first magnetic data only and subsequently considering also other constrains such as Motional Stark Effect (MSE). Results with magnetics only give a good qualitative and quantitative agreement between the codes while including MSE, as anticipated, a substantial improvement of the core plasma profiles is achieved.

## 1. INTRODUCTION

The reconstruction of Tokamak plasma equilibrium is a fundamental step in the understanding of fusion plasma physics since it sets the starting point for all subsequent plasma modelling applications and experimental data interpretation. Indeed, reliable and robust reconstructions of the plasma shape and position are crucial when steering plasma control, ensuring that the target scenario requested is met and that no machine operational limits are reached with the consequent termination of the discharge. In addition, interpretative plasma scenario modelling including additional heating and current drive physics modules as well as plasma stability strongly rely on the reference plasma equilibrium reconstruction being considered. The verification and validation of the numerical codes used to reconstruct plasma equilibrium, using all many available input experimental data - e.g. magnetic flux loops and magnetic field measurements, density and temperature diagnostics, polarimetry diagnostics and, when available, MHD markers as proxies for the safety factor profile - is an ambitious milestone that should ultimately provide full consistency between diagnostic data and physics model interpretation. For such an ambitious goal, it is easily recognised that multi code verification and validation is substantially facilitated when all codes share a common data model, physics data conventions, input data provenance and software infrastructure. This is the case of the integrated modelling framework developed by the EUROfusion Work Package on Code Development for Integrated Modelling (EU-IM) [1] and also more recently of the Integrated Modelling and Analysis Suite (IMAS) framework [2,3] developed by ITER. These frameworks are ideal testbed facilities for the verification of physics codes on arbitrary devices since the inherent complexity of adhering and interfacing to different datastructures, physics units or data storage I/O is avoided. In addition, one can easily adopt a device independent approach while designing and developing the scientific workflow, focusing on the device only when fine tuning the relevant set of code parameters.

In this work, results from a scientific workflow developed for the plasma equilibrium reconstruction on arbitrary Tokamak devices are shown, addressing dedicated plasma discharges on JET Tokamak. The workflow prototype is orchestrated in Kepler [4] and is being tested simultaneously on an IMAS modelling infrastructure installed on the EUROfusion Gateway cluster on MARCONI-HPC [5] and also on the FREIA cluster at JET. In Section 2, a brief description of the IMAS software infrastructure is made together with an overview of the workflow developed and some of the functionalities included. In Section 3 some results from two different JET discharges are shown with different sets of codes and equilibrium reconstruction constrains. Lastly in the Conclusions a summary of the work is presented and a discussion on the future improvements of the software suite included in the workflow.

## 2. THE IMAS MODELLING INFRASTRUCTURE AND EQUILIBRIUM RECONSTRUCTION WORKFLOW

The ITER Integrated Modelling and Analysis Suite (IMAS), from a software perspective, is easily portrayed as a modular set of software components that enable the development and execution of coupled modeling applications and data processing. Pivotal to its design, the concept of a “*data model*” that encompasses in detail all possible aspects of an integrated Tokamak modeling simulator i.e. from actuators used for plasma operation to transport solver numerics, facilitates enormously the communication between different physics actors. From an interfacing point of view, physics or signal processing components in a workflow communicate primarily by exchanging objects from a data dictionary using multi-language (Fortran, C++, Python, Java, among others) implementations of input and output methods. Similarly to the concept of Consistent Physical Objects (CPOs) developed and used in EU-IM [6], in IMAS there are Interface Data Structures (IDSs) e.g. equilibrium, magnetics, interferometry, core\_profiles, core\_sources, that are exchanged by the various components in the scientific workflow [3]. The data dictionary is meant to be fully independent of any particular data structure in use at the various EU Tokamak device facilities and sufficiently flexible in design to be extended according to particular needs and to ensure that a one to one correspondence between the different data models is possible. Accessing experimental data from the devices’ databases and populating an IDS database is easily doable, including by coding the data mapping and data exchange directly into the platform’s data access layer, transparently to the user. This is done using a Universal Data Access (UDA) plugin developed to parse the data access requests from the IMAS data access framework and map these to the local, experiment specific, data infrastructure and access APIs. The data obtained, as mapped from the IDS request, is then transformed as

required (data-scaling, reshaping, etc.) before being passed back to the IMAS data access framework where it is returned as an IDS data object. The user only sees the IDS data object and is isolated from the source of the data, whether it has come from a local IDS database or remotely via the UDA plugin.

The layout of the workflow developed in IMAS, as observed from the KEPLER graphical user interface, is shown in Fig. 1. Provisioning of the experimental data is obtained using a dedicated script using the UDA plugin to download and assign automatically the experimental data IDSs and that can be easily embedded as an actor in the workflow. The workflow offers the possibility to perform single time or multi time calculations using a pool of reconstruction codes that currently includes EQUAL [7], NICE [8] and EQUINOX [9] codes but is easily extendable to other codes such as EFIT++ [10] or CLISTE [11] once IMAS compliant actors for these codes become available. The post processing, included in the “Reconstruct” actor composite shown in Fig. 1, includes for the moment the automatic calculation of a high resolution equilibrium obtained from the reconstructed equilibrium applying a cut-off to the boundary at a prescribed normalized poloidal flux. Post-processing may also include calls to the SDSS [12] code for the calculation of confidence bands on the profiles in a non-probabilistic approach.

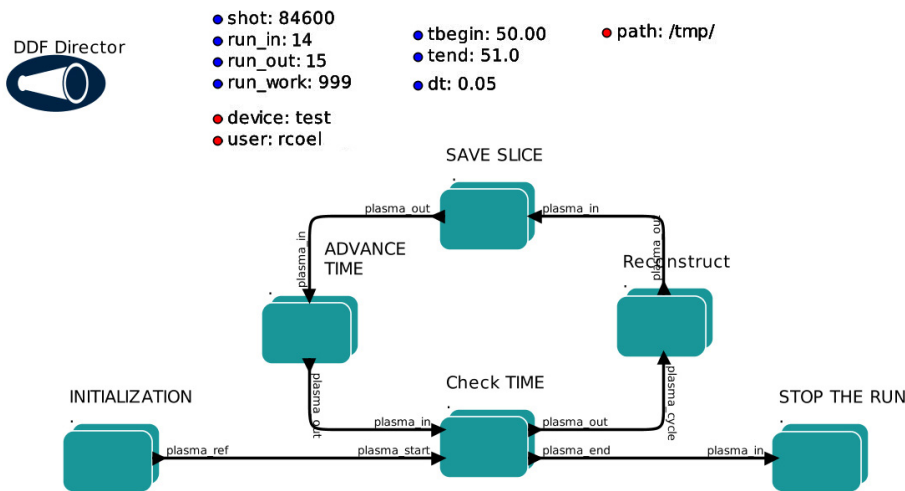

FIG. 1 – Layout of the equilibrium reconstruction workflow in Kepler. Workflow settings are available either on the canvas or on the appropriate composite actors (in green).

All codes featured in the workflow use the same categorization of physics and engineering data and the same methods for accessing the data, thus reducing one of the possible origins of mismatches on the reconstructed equilibria. The workflow orchestration and design can easily accommodate different types of use, e.g. reconstruction with magnetics data only or including additional diagnostic constrains. Simple switches with conditional logic are implemented that allow for using different codes in the pool set as shown in Fig. 2.

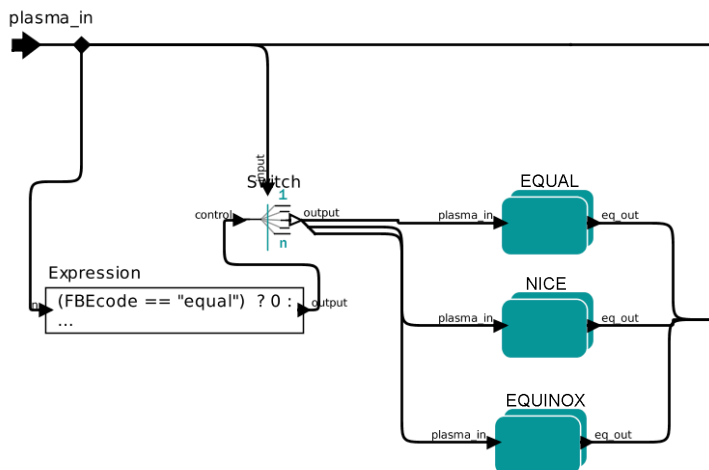

FIG.2 – Workflow selection of the currently available equilibrium reconstruction actors (set by parameter FBECODE).

### 3. EQUILIBRIUM RECONSTRUCTION RESULTS

As mentioned in Section 1, the underlying design of the modelling platform is flexible enough to allow for the same physics code to comply and run using different versions of the data model or workflow orchestration engine. In fact, different wrappers to the physics codes can easily be built with interfaces to the different type of hierarchical data models being used on input and output. Therefore, when comparing the physical results obtained by several codes, it is essential that all use the same underlying data model and that the data provenance is precisely the same. Taking this into consideration, two different JET plasma discharges were considered: #89140 and #84600. The former was analysed using both IMAS and EU-IM software infrastructures and the results shown correspond to the EU-IM case. The latter was analysed solely within IMAS, running either on the EUROfusion Gateway cluster installed in MARCONI HPC centre or on the FREIA cluster installed at JET. For #89140, EQUAL and EQUINOX codes were used and standalone EFIT results (data mapped into CPOs) ran on JET cluster are used as reference. For the #84600, EQUAL and NICE codes were used and an IMAS compliant EFIT++ version running on JET cluster is used as reference.

The JET hybrid discharge (#89140) was considered in order to highlight the influence of internal MSE data on the equilibrium reconstructions. As shown in Fig. 3, it has a plasma current and toroidal magnetic field of 1.4MA and 1.75T respectively and 12.5MW of NBI and 1.9MW of ICRH ([49-52s]). The discharge showed frequent (~200ms period) sawtooth activity during the NBI heated stage, as evidenced by the bursty behavior in the magnetic field perturbation with odd toroidal mode number (n-odd signal in Fig.3), a clear indication that the central safety factor  $q(0)$  should periodically drop below unity in between sawtooth crashes.

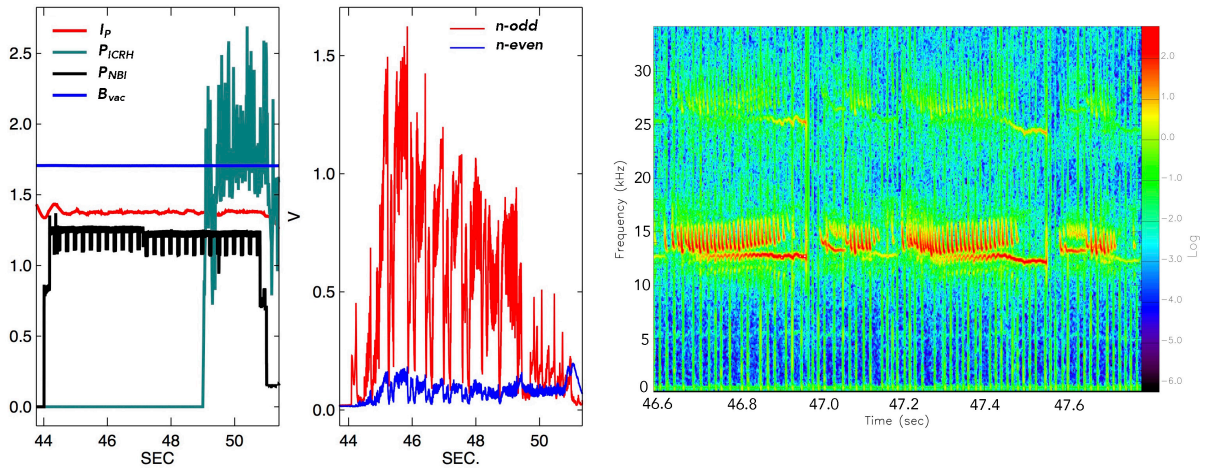

FIG. 3 – Details on JET plasma discharge #89140 (left), odd (red) and even (blue) toroidal mode number perturbed magnetic field amplitudes (middle) and spectrogram of Mirnov magnetic coil (right). Units and scale of plasma current ( $I_p$ ) are in MA, toroidal field ( $B_{vac}$ ) in Tesla, NBI power ( $P_{NBI}$ ) in 10MW and ICRH power ( $P_{ICRH}$ ) in MW.

The time chosen for the equilibrium reconstruction was  $t=47.45s$  since MSE measurements were available at that time and, coincidentally, a  $n=1$  sawtooth precursor was also present, indicating that a magnetic surface with safety factor  $q=1$  ought to be present and reconstructed by the codes. When using magnetics only, standard intra-shot EFIT fails to recover the  $q=1$  surface since  $q>1$  in the entire plasma volume. On the other hand, by properly tuning the codes with less aggressive profile regularizations (as done for EFIT and EQUAL but not on EQUINOX for comparison), one can recover  $q<1$  in the deep core although, as anticipated, the sawtooth crash cycle oscillations remain unresolved. The comparison between EFIT (labeled ‘EFTF’ to distinguish for magnetic only), EQUAL and EQUINOX is shown in Fig. 4, where the poloidal magnetic flux map is shown on the left together with profiles of plasma pressure (P), flux surface averaged toroidal current density ( $J_{phi}$ ) and safety factor (q). The time traces for the on axis safety factor is also shown on the right panel.

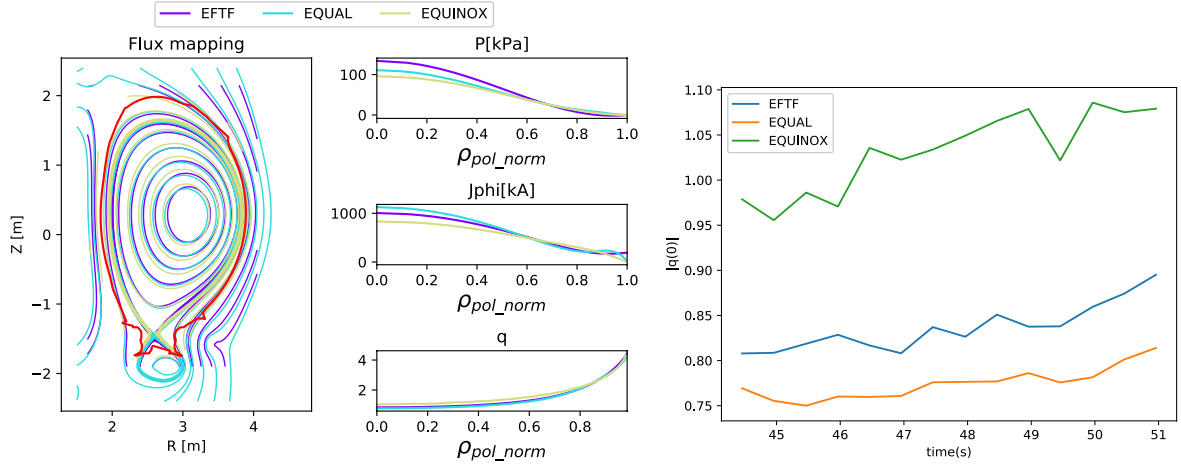

FIG. 4 – Plasma equilibrium reconstruction at  $t=47.45s$  using magnetic only for #89140 (left) and time traces of the computed safety factor on axis (right).

Good agreement is found with EFIT in the plasma boundary ( $<1cm$  for EQUAL,  $<2cm$  for EQUINOX at outer midplane) and divertor strike points ( $<2.5cm$ ) is found and fitting errors in the magnetics are below the experimental 5mT error (see Fig. 5). Even with magnetics only, the regularisations chosen in EQUAL allowed for some relaxation in the edge profiles and, in view of the ELMy character of the discharge, indicate some traces of a pedestal at the edge. This is however insufficient to resolve the pressure profile at the edge and kinetic pressure assisted reconstructions are mandatory which shall be included in future versions of the workflow.

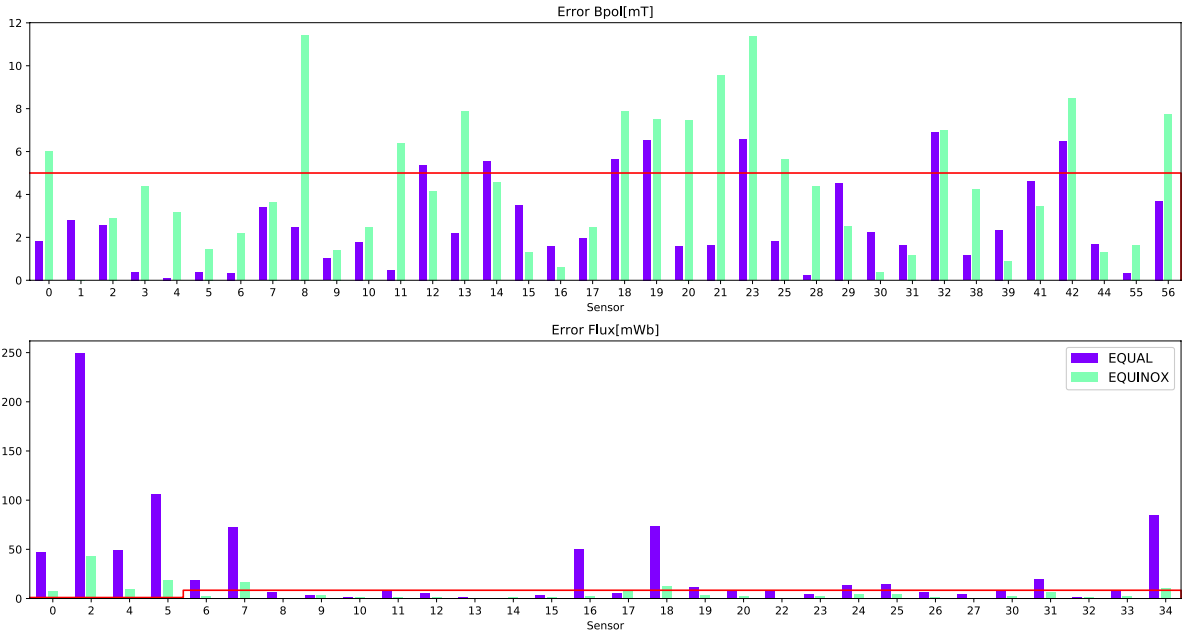

FIG. 5 – Fitting errors on magnetic sensors for equilibrium reconstruction at  $t=47.45s$  for #89140. Red signal indicates the absolute errors on the measurements.

When MSE data is included as a constrain, a clear improvement on the overall agreement in the  $q$ -profile ( $<5\%$  difference in  $q(0)$  among the 3 codes) is obtained as shown in Fig. 6. The  $q$ -profile is also in agreement with preliminary estimates of the  $q=1$  surface from the inversion radius in electron temperature profile as observed before and after the sawtooth crash occurring at  $t\sim 47.55s$ . Considering the relatively high experimental error on the magnetics, although mostly an “internal constrain” (edge channels not used as constrains), MSE assisted reconstructions may lead to some changes on the geometry of the plasma separatrix of the best fitted solution, with differences in X-point location and strike points observed to vary by less than 1.5cm when comparing magnetics only for instance with EQUAL code. The constant time traces and jump at  $t=49.5s$  indicated by EQUINOX are simply due to too coarse grid resolution and thus a very rough estimate.



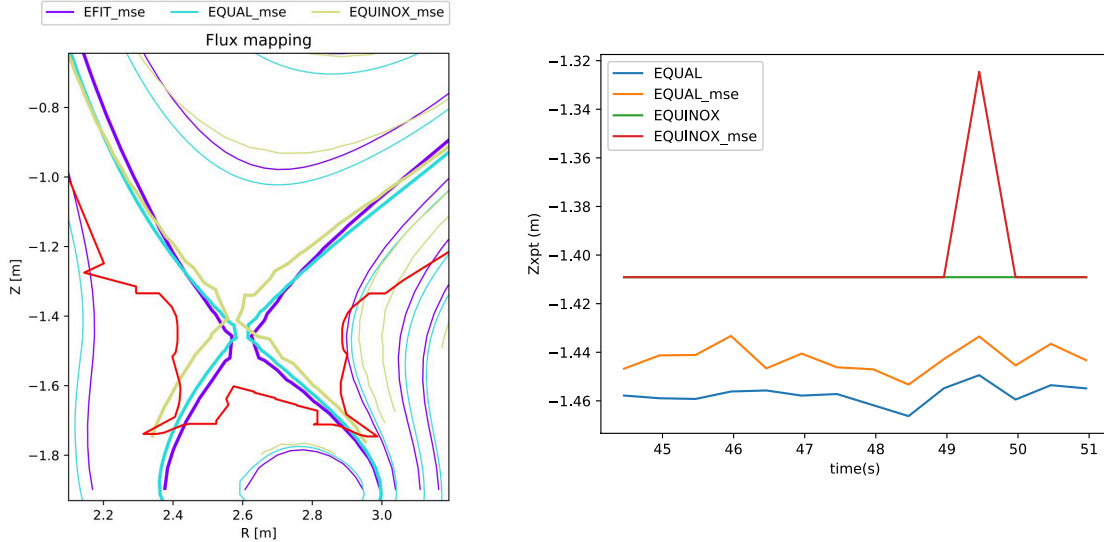

FIG. 6 – Details on divertor region for equilibrium reconstruction at  $t=47.45s$  for #89140 with MSE constrain (left) and time evolution of the lower X-point Z-coordinate with magnetics only and MSE assisted using EQUAL and EQUINOX (right). The jump at  $t\sim 49.5$  observed in EQUINOX with MSE data is simply a grid resolution artifact.

The JET discharge (#84600) was considered next in order to compare EFIT++, EQUAL and NICE codes, all running within IMAS software infrastructure, using only magnetics data. Although the experimental dataset used by the 3 codes is the same, different functional types (B-splines for EQUAL/NICE and first order polynomial for EFIT++) are used for  $dP/d\psi$  and  $FdF/d\psi$  ( $\psi$  is the poloidal magnetic flux) and slightly different regularisations (but all penalizing sharp gradients at the edge) are used. As shown in Fig. 7, discharge #84600 is characterized by plasma current of  $\sim 2MA$ , toroidal magnetic field of  $\sim 1.9T$  and NBI assisted heating starting at 9.5MW and dropping to  $\sim 6.5MW$ . Similarly to #89140, the discharge showed frequent ( $\sim 200ms$  period during 6.5MW NBI stage) sawtooth, eventually disappearing by  $t\sim 52.5s$ .

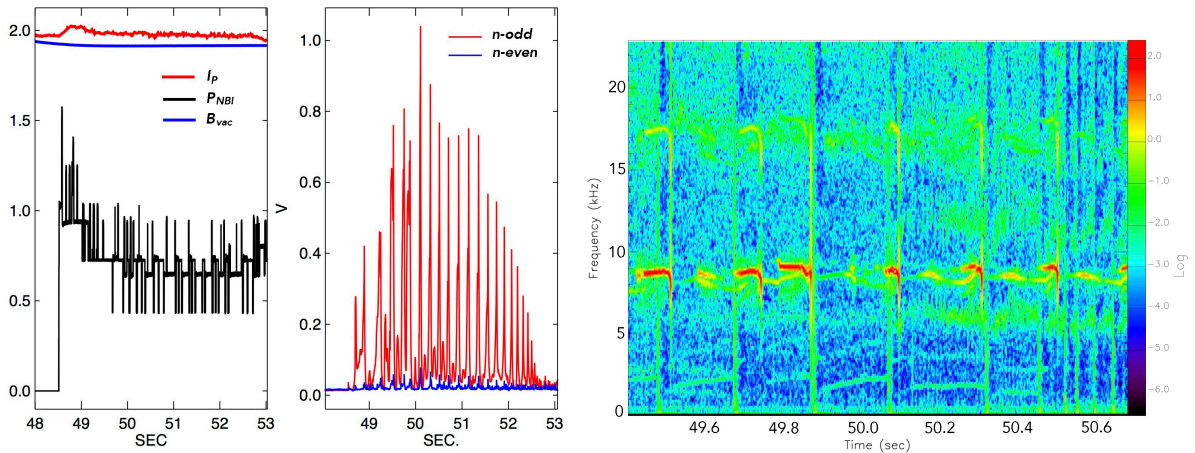

FIG. 7 – Details on JET plasma discharge #84600 (left), toroidal mode number perturbed magnetic field amplitudes (middle), and spectrogram of Mirnov magnetic coil (right). Units and scale of plasma current ( $I_p$ ) are in MA, toroidal field ( $B_{vac}$ ) in Tesla and NBI power ( $P_{NBI}$ ) in 10MW.

Similarly to #89140, the chosen time instant ( $t=50.0s$ ) sits in between 2 consecutive sawtooth crashes, indicating that the  $q=1$  surface should be present in the plasma. In addition, as the discharge evolves and the sawteeth become smaller in amplitude and eventually vanish, one should expect an increase of the on axis safety factor  $q(0)$ . In Fig. 8 one shows the equilibrium reconstruction results at  $t=50s$ , showing the flux map and relevant profiles as well as the time traces of the on axis safety factor. As it is easily observed, all three codes correctly reproduce the increase in core safety factor that is consistent with mitigation of the sawteeth.

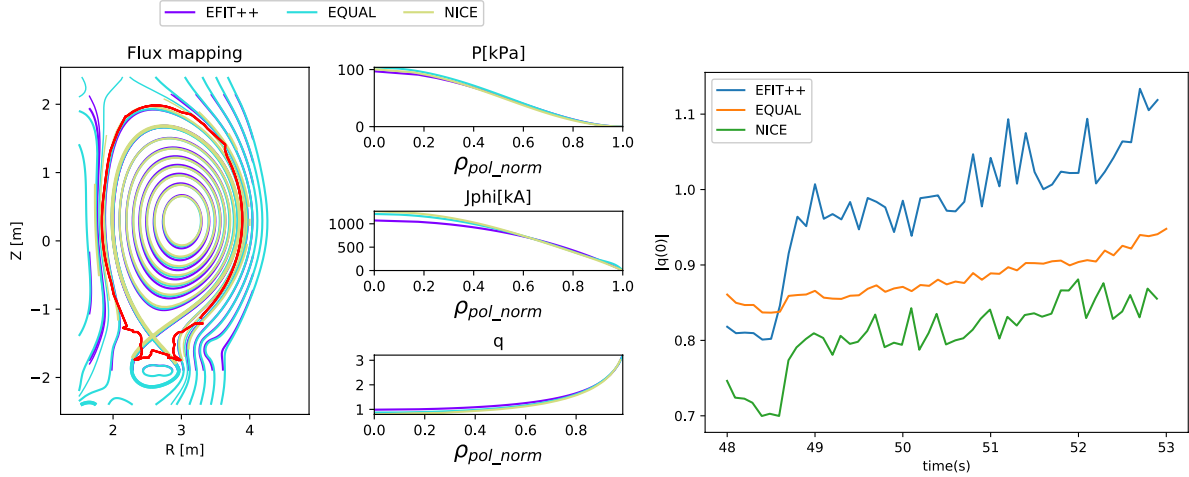

FIG. 8 – Plasma equilibrium reconstruction at  $t=50.0s$  using magnetic only for #84600 (left) and time traces of the computed safety factor on axis (right).

The sawtooth inversion radius as inferred from High Resolution Thomson scattering indicates that the  $q=1$  surface is located at normalised rho poloidal radius around 0.4, in closer agreement with the estimates from EQUAL. Similarly to the case of #89140, results on the plasma geometry including the separatrix are in close agreement among the three codes as inferred from Fig. 9. However, an offset of 2.5cm on radial position of Low Field Side strike point is found when comparing the code results with estimates from Infra Red camera peak heat flux data taking into account cross field transport.

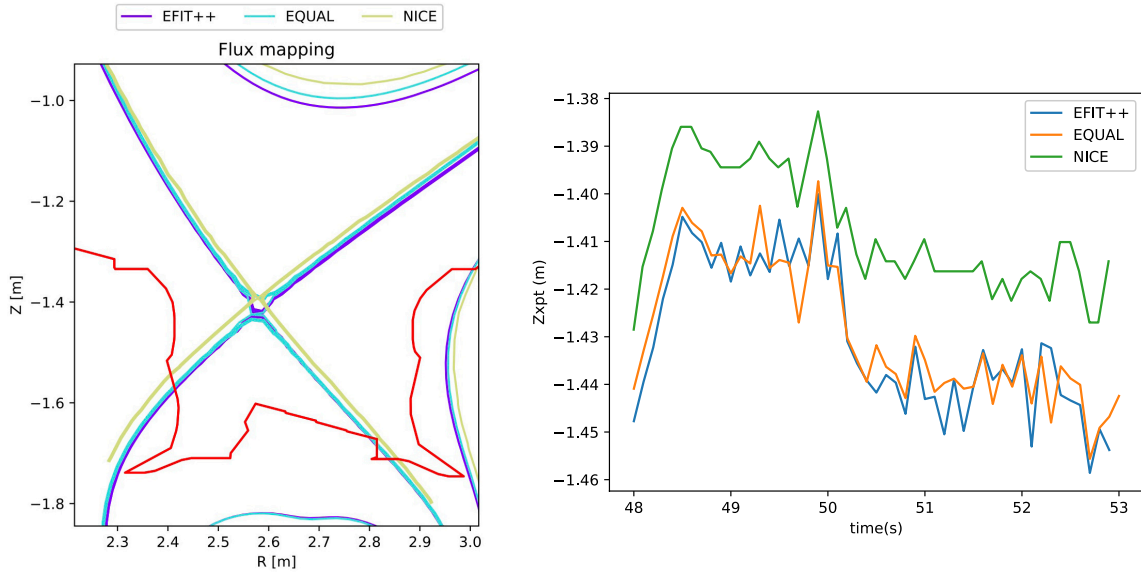

FIG. 9 – Details on divertor region for equilibrium reconstruction at  $t=50.0s$  for #84600 with magnetic only (left) and time evolution of the lower X-point Z-coordinate (right).

#### 4. CONCLUSIONS

In this paper first results on the plasma equilibrium reconstructions of JET discharges using the IMAS modelling infrastructure installed at JET as well as the EU-IM platforms were shown. A Kepler workflow was developed which performs routine equilibrium reconstructions over the whole pulse, using at present only magnetic diagnostics and MSE measurements as constrains. The results on JET discharges #89140 and #84600 primarily demonstrate the modular workflow approach, with a reasonable agreement between the several reconstruction codes involved even though slightly different regularisations in the reconstructions are used. Plasma boundary characteristics e.g. X-point, strike points, outer and inner gaps show differences between the codes within a  $\sim 2cm$  range and  $q$ -profile estimation in the core is shown to be sensitive to the regularization



used but with  $q=1$  surfaces clearly present during sawteeth activity. Motional Stark Effect is also clearly beneficial in providing more accurate estimations of the magnetic flux and field distributions in the core of the plasma. It is worth noting that the results are preliminary, far from optimal and do not include the error bars on the time traces or profiles. As such they should be interpreted primarily as a practical demonstration of the workflow. Future developments to the workflow include the addition of a dedicated actor that connects to experimental database, imports the diagnostic data and fills in the appropriate IDSs, include Stokes polarimetry as a constrain (recent development on NICE code [8]) and also thermal plasma pressure. The work presented here also demonstrated the portability of IMAS, as the same workflow design and implementation can work seamlessly on different computer clusters (EUROfusion Gateway within MARCONI-HPC and FREIA cluster at JET) running a different software environment with IMAS infrastructure installed and IDS and Kepler compliant versions of the physics codes.

## ACKNOWLEDGEMENTS

This work has been carried out within the framework of the EUROfusion Consortium and has received funding from the Euratom research and training programme 2014-2018 under grant agreement No 633053. IST activities also received financial support from “Fundação para a Ciência e Tecnologia” through project UID/FIS/50010/2013. The views and opinions expressed herein do not necessarily reflect those of the European Commission.

## REFERENCES

- [1] FALCHETTO G. L. et al The European Integrated Tokamak Modelling (ITM) effort: achievements and first physics results, *Nucl. Fusion* **54** (2014) 043018
- [2] PINCHES S.D. et al, “Progress in the ITER Integrated Modelling Programme and the Use and Validation of IMAS within the ITER Members”, Proc. 26th IAEA FEC, Kyoto, Japan, 2016, paper TH/P2-14.
- [3] IMBEAUX F., et al, Design and first applications of the ITER integrated modelling & analysis suite, *Nucl. Fusion* **55** 12 (2015) 123006
- [4] <https://kepler-project.org/>
- [5] VOITSEKHOVITCH I. et al, Recent EUROfusion Achievements in Support of Computationally Demanding Multiscale Fusion Physics Simulations and Integrated Modeling, *Fus. Sci and Technol.* **74** (2018) 186-197
- [6] IMBEAUX F. et al *Computer Physics Communications* **181** (2010) 987-998
- [7] ZWINGMANN W., Equilibrium analysis of steady state tokamak discharges, *Nucl. Fusion* **43** 9 (2003) 842-850
- [8] FAUGERAS B. et al, Equilibrium reconstruction at JET using Stokes model for polarimetry, *Nucl. Fusion* **58** (2018) 106032
- [9] FAUGERAS B. et al., 2D interpolation and extrapolation of discrete magnetic measurements with toroidal harmonics for equilibrium reconstruction in a tokamak, *Plasma Phys. Control Fusion* **56** 11 (2014) 114010
- [10] APPEL L. C. et al, Equilibrium reconstruction in an iron core tokamak using a deterministic magnetisation model, *Comp. Phys. Commun.* **223** (2018) 1-17
- [11] McCARTHY P. J., Analytical solutions to the Grad-Shafranov equation for tokamak equilibrium with dissimilar source functions, *Phys. Plasmas* **6**, (1999) 3554-3560
- [12] COELHO R. et al, Evaluation of Epsilon-Net Calculated Equilibrium Reconstruction Error Bars in the European Integrated Modeling Platform, *Fusion Sci. Technol.* **69** (2016) 611-619