



HAL
open science

A generic method of pulse width modulation applied to 3-Level T-type NPC inverter

Simon Cailhol, Frédéric Rotella, Paul-Etienne Vidal

► **To cite this version:**

Simon Cailhol, Frédéric Rotella, Paul-Etienne Vidal. A generic method of pulse width modulation applied to 3-Level T-type NPC inverter. Power Electronics and Motion Control Conference (PEMC), Sep 2016, Varnia, Bulgaria. pp.20-25. hal-01944474

HAL Id: hal-01944474

<https://hal.science/hal-01944474>

Submitted on 4 Dec 2018

HAL is a multi-disciplinary open access archive for the deposit and dissemination of scientific research documents, whether they are published or not. The documents may come from teaching and research institutions in France or abroad, or from public or private research centers.

L'archive ouverte pluridisciplinaire **HAL**, est destinée au dépôt et à la diffusion de documents scientifiques de niveau recherche, publiés ou non, émanant des établissements d'enseignement et de recherche français ou étrangers, des laboratoires publics ou privés.





Open Archive Toulouse Archive Ouverte

OATAO is an open access repository that collects the work of Toulouse researchers and makes it freely available over the web where possible

This is an author's version published in: <http://oatao.univ-toulouse.fr/20013>

To cite this version:

Cailhol, Simon  and Rotella, Frédéric  and Vidal, Paul-Etienne  *A generic method of pulse width modulation applied to 3-Level T-type NPC inverter.* (2016) In: Power Electronics and Motion Control Conference (PEMC), 28 September 2016 - 25 September 2016 (Varnia, Bulgaria).

Any correspondence concerning this service should be sent to the repository administrator: tech-oatao@listes-diff.inp-toulouse.fr

A generic method of Pulse Width Modulation applied to 3-Level T-type NPC inverter

Simon Cailhol, Paul-Etienne Vidal and Frédéric Rotella
Laboratoire Genie de Production (LGP), Université Fédérale de Toulouse,
INPT/ENIT, 47 avenue d'Azereix, 65016 Tarbes Cedex, France.
Email: {simon.cailhol; paul-etienne.vidal; frotella}@enit.fr

Abstract—This paper illustrates the application of a method based on the resolution of linear systems to an uncommon inverter switching cell. This study describes the mathematical model of the modulated inverter leg associated at the considered structure. The generalized inverse of a matrix is used to generate the admissible conduction rates. Among the modulation strategies obtained, three specific modulation schemes are proposed and discussed thanks to the generic mathematical standpoint used.

I. INTRODUCTION

Electrified systems are of growing importance in many applications developed today. Among them, some widespread common applications such as, pipeline pumps [1], fans [2], water pumping stations [3], traction applications [4] concern medium voltage converters. New trends for converter design, emerging from eco-friendly applications are nowadays studied such as grid integration of renewable-energy sources [5], reactive-power compensation [6] in order to maximize the system efficiency and so on. It is noted that these applications need a control over the exchanged energy. Consequently, the converter architecture mainly concerns inverter topology.

Emergence of wide band gap semi-conductors combined with new limits for usual silicone devices leads to new interest for developing original inverter topologies. Indeed, studies work on the correlation of a given architecture and its dedicated modulation strategy with an application. Among these studies, the multi-levels architecture and particularly those using the Neutral Point Clamped were widely studied. Firstly dedicated to high power application, a spin-off topology, named three level T-type converter - $3LT^2C$, is under interest. Effectively, this topology benefits of its ability at being used in high power photovoltaic systems [7], as well as variable speed drives for low voltages applications, [8]. Moreover, it has been demonstrated that a $3LT^2C$ increases the converter efficiency compared to similar multilevel inverters, with respect to power losses, and more precisely compared to a 3-levels Neutral Point Clamped -NPC- topology, [9], [13].

Studies demonstrated that the modulation strategy of a 3-level NPC can also be applied to this topology. Indeed, usual carrier based Pulse Width Modulation - PWM associated with 2 carriers waveforms [10], or Space Vector Modulation - SVM which allows harmonic selection [11], have been successfully tested. Nevertheless, the major drawbacks of such inverter topology concern the control of the common mode voltage or the unbalance voltage of DC input sources. Most

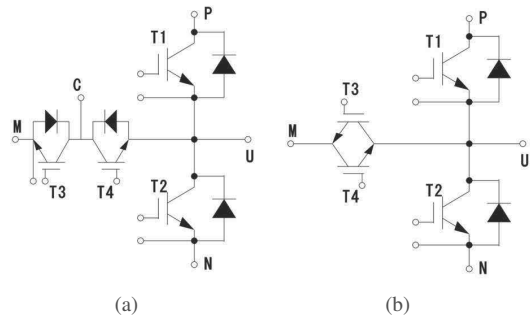

Fig. 1. T-type switching cells [14]. (a) Normal, (b) RB-IGBT based.

of the modulation strategies aim at solving these topology drawbacks.

It appears to our knowledge that it does not exist any generic modulation model of $3LT^2C$ converter. The aim of the study is to adapt the modeling technique proposed in [12] in order to establish a generic inverter modulation model of such structure, that can match the following criteria:

- to be applied to carrier based PWM;
- to be extended to SVM principles;
- to highlight how to implement a generic modulation scheme;
- to define modulation admissible solutions.

The first part of the paper is devoted to describe the considered structure and proposes a mathematical model. The second part deals with determination of control strategies by using a generic mathematical method. Finally, among the whole solution set, 3 specific modulation strategies are highlighted and discussed.

II. T-TYPE SWITCHING CELL

From a practical point of view, a $3LT^2C$ inverter is made of three legs based on a common switching cell structure. The switching cell can be built from 2 ideas, as illustrated in Fig. 1. This figure depicts electrical equivalent circuits of available commercial modules. As far as the modulation model is concerned, the switching cell can be considered as three elementary ideal switches, associated to two independent and perfect input voltage sources as illustrated in Fig. 2.

The inverter cell considered is made of three switches, named K_1 , K_2 , K_3 respectively. As this cell is an elementary switching cell, only one switch can be turned on at once.

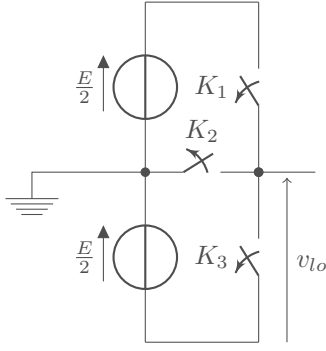

Fig. 2. Elementary cell structure.

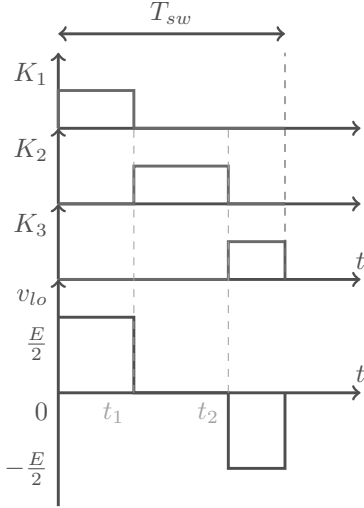

Fig. 3. Example of a switching sequence.

Moreover, due to the switches connection, there is no short-circuit of the input voltage sources. Each switch is able to apply a given voltage to the output line v_{lo} as given in Table I. The other possibilities are not allowed.

TABLE I
OUTPUT VOLTAGES.

K_1	K_2	K_3	v_{lo}
0	0	0	0
1	0	0	$\frac{E}{2}$
0	1	0	$\frac{E}{2}$
0	0	1	0

Fig. 3 gives an example of a switching sequence and the corresponding line voltage during T_{sw} . For notational comforness, the switching frequency $f_{sw} = \frac{1}{T_{sw}}$ is used in the following of the paper.

As exemplified in Fig. 3, t_1 is the time when K_1 is closed. Then K_2 is switched on from t_1 to t_2 , and finally K_3 between t_2 and T_{sw} . Let us define, τ_i , $i \in \{1; 2; 3\}$ as the conduction rates of switch K_i over T_{sw} :

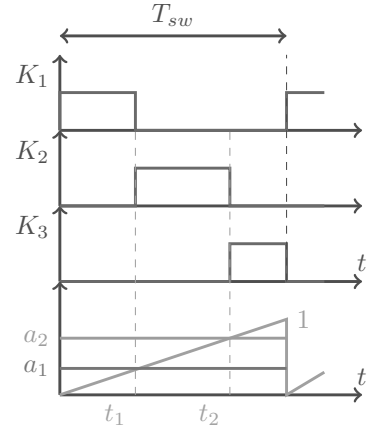

Fig. 4. Command orders generation principle.

$$\begin{aligned} \tau_1 &= \frac{t_1}{T_{sw}} \\ \tau_2 &= \frac{t_2 - t_1}{T_{sw}} \\ \tau_3 &= \frac{T_{sw} - t_2}{T_{sw}}. \end{aligned} \quad (1)$$

Let us denote a_1 and a_2 as

$$\begin{cases} a_1 = \tau_1 \\ a_2 = \tau_1 + \tau_2. \end{cases} \quad (2)$$

The switching time t_1 and t_2 are used for command orders generation. They are then obtained comparing a_1 and a_2 to a sawtooth signal defined between 0 and 1 at frequency f_{sw} as illustrated in Fig. 4. It is noted that the command order for K_3 , is obtained thanks to $T_{sw} - t_2$. It is obvious that these values of c_i are deduced from Tab. I. Consequently, this modulation scheme ensures only one or zero switching, of a given switch within T_{sw} .

Such elements lead to the expression of the mean value of the line voltage over the switching period, noted V_{lo} , as

$$\langle v_{lo} \rangle_{T_{sw}} = V_{lo} = \frac{E}{2} (-a_1 - a_2) + \frac{E}{2}. \quad (3)$$

Defining $V_{lo}^* = V_{lo} - \frac{E}{2}$ leads to the relationship

$$V_{lo}^* = -\frac{E}{2} Aa \quad (4)$$

where $A = [1 \ 1]$ and $a = [a_1 \ a_2]^T$. Immediately, an advantage of such a model appears: a carrier based modulation scheme is used, associated with a single carrier easily generated. The control strategy vector a appears as the solution of the linear system described in (4).

III. CONTROL STRATEGIES

A. Generic solutions

$\text{rank}(A) = \text{rank}[AV_{lo}]$ thus, the system model (4) is consistent. Due to the fact that $\text{rank}(A) = 1$, while the number of columns of A is $n = 2$, it exists an infinity of solutions for a . Consequently, some degrees of freedom will be highlighted. It will be demonstrated in the following section how to accurately determine these degrees of freedom. Let us denote V_{ref}^* the voltage which should be obtained when measuring $V_{lo} - \frac{E}{2}$. The set of solutions to modulate the reference voltage V_{ref}^* is thus defined using the generalized inverse theory [15]. Among the possible generalized inverse of A , the pseudo-inverse, denoted A^\dagger , will be used. It is unique and because A is full row rank matrix [15], a simple expression for A^\dagger can be computed:

$$A^\dagger = (AA^T)^{-1} A^T = \frac{1}{2} \begin{bmatrix} 1 \\ 1 \end{bmatrix}. \quad (5)$$

Thus the solution of (4) can be written

$$a = -\frac{2}{E} A^\dagger V_{ref}^* + (I - A^\dagger A) z \quad (6)$$

where z is an arbitrary 2-dimensional vector. Then, the solutions can be split in two parts summed up as:

- a fixed solution: $-\frac{2}{E} A^\dagger V_{ref}^*$, which can be written $a_{ref} \begin{bmatrix} 1 & 1 \end{bmatrix}^T$ with $a_{ref} = -\frac{1}{E} V_{ref}^*$;
- a free solution $(I - A^\dagger A) z$.

Looking at the free solution, it appears that some degrees of freedom are revealed from $(I - A^\dagger A) z$. The number of degrees of freedom n_λ is

$$n_\lambda = \dim(\text{Ker}(A)) = n - \text{rank}(A) = 1. \quad (7)$$

To express the degree of freedom λ , the goal is to define a $(n \times n_\lambda)$ sized matrix M such as, it exists a N matrix as $MN = I - A^\dagger A$ and $Nz = \lambda$. This factorization is not unique. Nevertheless, the maximal rank factorization eases the degree of freedom exhibition such as

$$(I - A^\dagger A) z = \begin{bmatrix} 1 & -1 \\ -1 & 1 \end{bmatrix} z = \begin{bmatrix} -1 \\ 1 \end{bmatrix} \begin{bmatrix} -1 & 1 \end{bmatrix} z = \begin{bmatrix} -1 \\ 1 \end{bmatrix} \lambda. \quad (8)$$

Finally, the final control vector is obtained as

$$a = a_{ref} \begin{bmatrix} 1 \\ 1 \end{bmatrix} + \lambda \begin{bmatrix} -1 \\ 1 \end{bmatrix}. \quad (9)$$

B. Implementation constraints

Among the solution set expressed in (9), some solutions are constrained from the system considered. Indeed, components of a have to be in $[0, 1]$, and, they are to be ordered. Finally, three main relationships are taken into account:

- $0 \leq a_i \leq 1$, applied to a_1 and a_2 respectively in order to check the linearity functioning zone of the inverter. Consequently, it is obvious that over-modulation is not concerned by this modelling method;

- $a_2 \geq a_1$ because $t_2 - t_1 \geq 0$ to avoid short-circuit of the upper voltage source. This ensures the feasibility of the switching sequence illustrated in Fig. 4.

All the physical constraints can be summarized with

$$0 \leq a_1 \leq a_2 \leq 1. \quad (10)$$

Therefore, the first step in order to set the degree of freedom of the system, aims at guaranteeing the practical conditions compatibility for implementation. To do so, lower and higher margins for the degree of freedom λ , respectively λ_{low} and λ_{high} , are defined such as

$$\lambda_{low} \leq \lambda \leq \lambda_{high}. \quad (11)$$

Taking into account the constraint $a_2 \leq 1$ allows to define a limit

$$\begin{aligned} a_2 = a_{ref} + \lambda &\leq 1 \\ \Leftrightarrow \lambda &\leq 1 - a_{ref}. \end{aligned} \quad (12)$$

In a similar manner, another limit for λ is expressed and computed from the constraint $0 \leq a_1$:

$$\begin{aligned} a_1 = a_{ref} - \lambda &\geq 0 \\ \Leftrightarrow \lambda &\leq a_{ref}. \end{aligned} \quad (13)$$

The third constraint leads to

$$\lambda \geq 0. \quad (14)$$

Finally, the boundaries for λ given in (11) are set, thanks to (12) (13) and (14) so that:

$$\begin{aligned} \lambda_{low} &= 0 \\ \lambda_{high} &= \min(a_{ref}, 1 - a_{ref}). \end{aligned} \quad (15)$$

As a first consequence, the maximal (resp. minimal) V_{lo} is $\frac{E}{2}$ (resp. $-\frac{E}{2}$). Thus, the maximal fundamental magnitude of a modulated sinusoidal waveform of such a structure, is $\frac{E}{2}$. To conclude, all positive λ chosen between the margins expressed in (15) satisfies (10). Thus, Eq. (15) guaranties the linearity of the modulation function.

However, λ still has to be defined among this interval. Fig. 5 depicts the fixed solution a_{ref} and the margins λ_{low} and λ_{high} . The domain in which λ satisfies the system constraints is highlighted. The magnitude of the reference voltage is here set first at $\frac{E}{3}$ (from $t = 0$ to 50 ms) and then at $\frac{E}{2}$ (from $t = 50$ to 100 ms). When the magnitude of the reference voltage equals $\frac{E}{2}$, at some points, the only λ satisfying the system constraint is $\lambda = 0$.

C. Setting specific solutions

In this study three λ are considered:

- 1) $\lambda = \lambda_{low} = 0$ defines $t_1 = t_2$, leading to a classical switching cell by not using K_2 ;
- 2) $\lambda = \lambda_{high}$ fixes $t_1 = 0$ or $t_2 = T_{sw}$, leading to a reduction of the switching losses (K_1 or K_3 is not used) while getting $\frac{E}{2}$ edges on V_{lo} ;
- 3) $\lambda = \frac{\lambda_{low} + \lambda_{high}}{2}$ leading to the maximization of the time between the switching (λ is as far from λ_{low} and from λ_{high}).

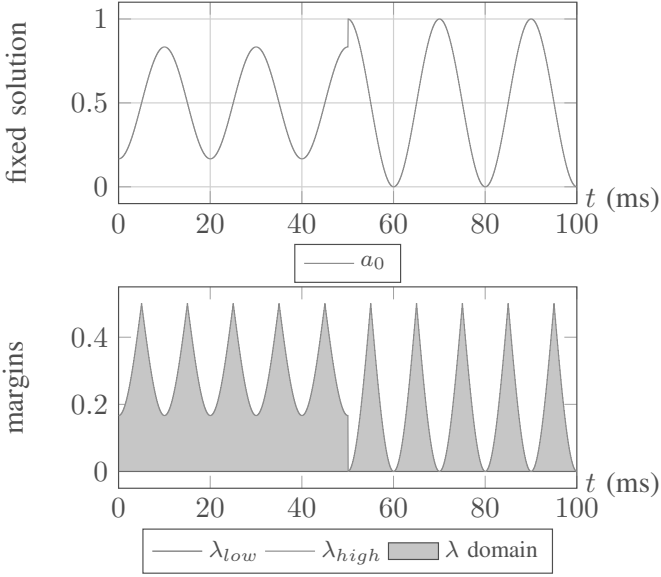

Fig. 5. Fixed solution and margins for the degree of freedom λ .

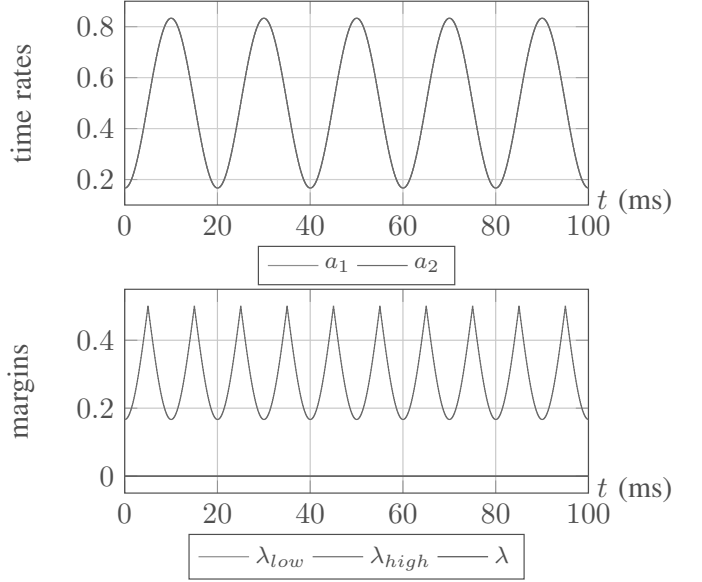

Fig. 6. $\lambda = 0$, time rates and margins

IV. SIMULATION

A Scilab [16] testbench based on the switching cell given in Fig. 2 has been developed to test the three strategies proposed. The cell is connected to a $E = 100$ V DC bus. The switching frequency is set at $f_{sw} = 10$ kHz. The three modulation strategies have been tested by modulating a 50 Hz 50 V peak sinusoidal waveform.

The proposed strategies are able to generate a signal which fundamental correspond to the desired reference voltage.

A. $\lambda = \lambda_{low} = 0$

This strategy introduces no shift between a_1 and a_2 (Fig. 6). Consequently, the switch K_2 is not used - K_2 is off - and the switching cell is working as a usual two-levels/two-switches cell (Fig. 7). They are plotted for half a period of the sinusoidal waveform. On the one hand, K_2 never switches which reduces the switching losses by reducing the number of switching at each switching period. On the other hand, this strategy increases the harmonic distortion of the switched current, due to the lower number of switching. Moreover, the high magnitude of the switching edges, $\Delta v_{lo} = E$ seems to be an important factor - and also a drawback - concerning resonance phenomena as well as overall quality of currents induced.

B. $\lambda = \lambda_{high}$

Choosing $\lambda = \lambda_{high}$ introduces a difference between a_1 and a_2 as illustrated in Fig. 8. The three switches are thus used as displayed in Fig. 9. However, this figure points out that K_2 is switched all along the period of V_{ref} , while K_1 and K_3 are used on half a period only. Such a strategy leads to clamp alternatively the time rates to 0 for a_1 , and 1 to a_2 . Indeed, K_1 and K_3 are only used during the lower, respectively higher, part of V_{ref} . Similarly as the previous strategy, it can be guaranteed some low switching losses, and

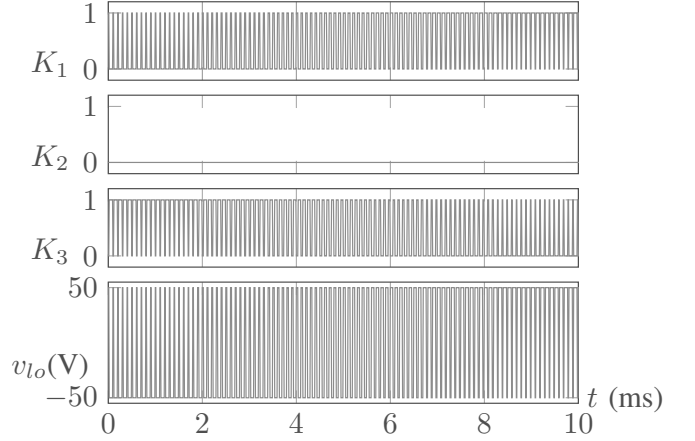

Fig. 7. $\lambda = 0$ switches sequence and output voltage

high harmonic distortion also. Let us notice that this strategy does not suffer from the same drawback as the resonance sensitivity is concerned. Indeed, the voltage edge is smaller: $\Delta v_{lo} = \frac{E}{2}$.

C. $\lambda = \frac{\mu_{low} + \mu_{high}}{2}$

This strategy involves all the switches of the cell at each switching period. It implies no saturation of a_1 at 0 or a_2 at 1 for more than one switching period, as shown in Fig. 10. Thus, compared to previous strategies already described, it leads to an increase of the switching losses: three switching occur at each switching period (Fig. 9). A first advantage is to obtain a low distortion signal. Moreover, due to the mitigated voltage edge encountered, $\Delta v_{lo} = \frac{E}{2}$ and $v_{lo} = E$, the influence of connection parasitic elements on resonant phenomena is limited as displayed in Fig. 12. This figure, highlights that

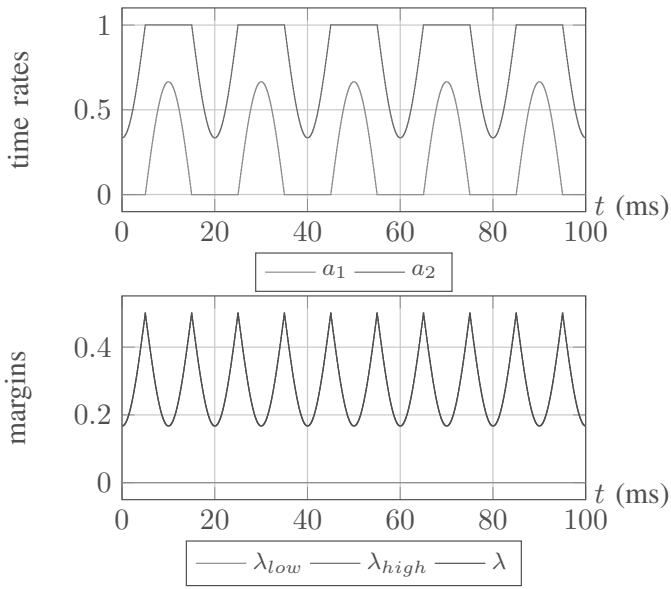

Fig. 8. $\lambda = \mu_{high}$

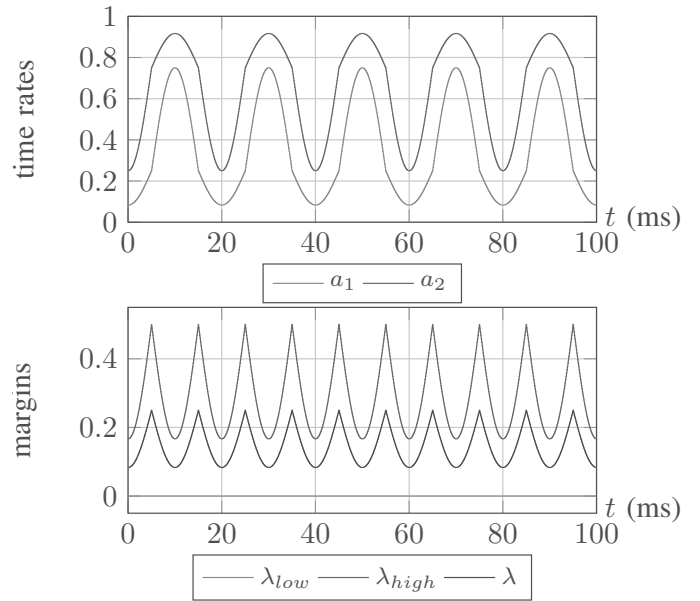

Fig. 10. $\lambda = \frac{\mu_{low} + \mu_{high}}{2}$

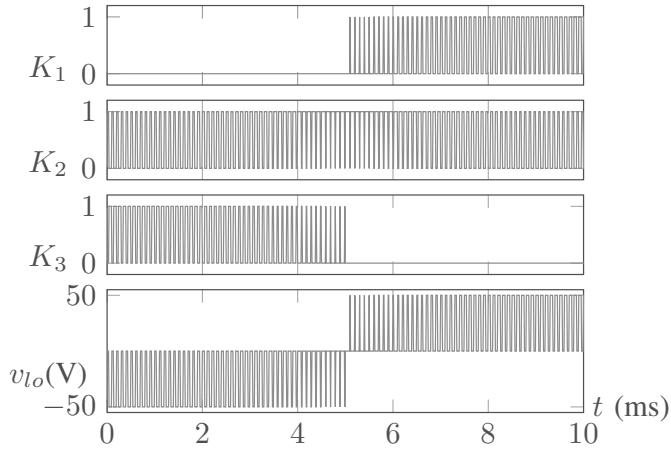

Fig. 9. $\lambda = \frac{\mu_{low} + \mu_{high}}{2}$ switches sequence and output voltage

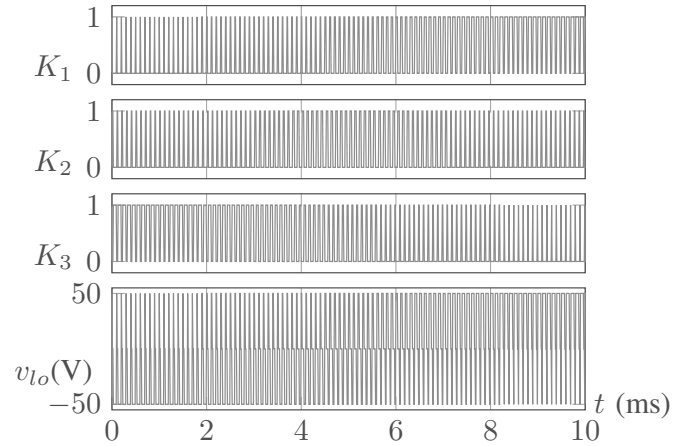

Fig. 11. $\lambda = \frac{\mu_{low} + \mu_{high}}{2}$ switches sequence and output voltage

modelling scheme given in Fig. 4 is fulfilled. Let us remark that the rising edges can be split by using a triangle carrier. Consequently, it will produce only $\Delta v_{lo} = \frac{E}{2}$ voltage edges. Moreover, every carrier waveforms is suitable to the proposed modulation scheme.

V. CONCLUSION

This paper illustrates the application of a method based on the generalized inverse to solve linear systems. It is applied to a $3LT^2C$ inverter switching cell. In a first step, the study describes the mathematical model of the modulated inverter leg. The modulation scheme revealed, is based on a carrier based PWM scheme. Then a pseudo-inverse is used to generate the admissible solution set. Among the solution set obtained, 3 specific solutions are discussed. They are compared from the

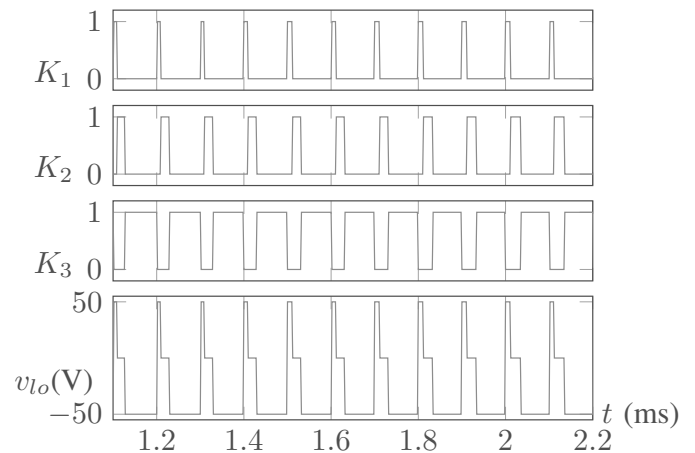

Fig. 12. Zoom on output voltage v_{lo}

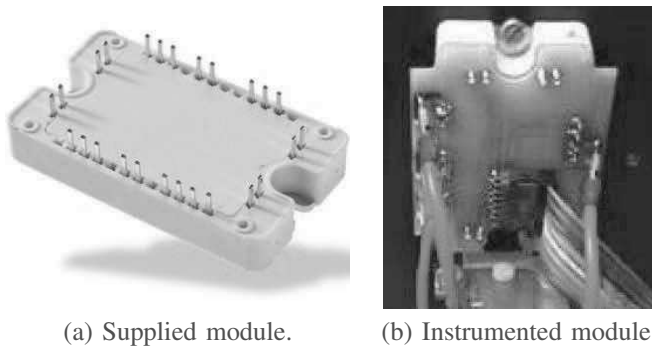

Fig. 13. Microsemi T-type module.

switching losses and voltage edges, point of view. Simulation results are provided.

As far as the method is concerned, it is pointed out that a single carrier is needed while all possible solutions are highlighted. Because the modulating signal obtained is compatible to a time rate and related to a switching time, it can be inserted in a SVM scheme. This is due to the fact that the modulation modelling method is generic.

This study considered an insulated 3-switches cell. It is obvious that this structure can be connected to similar structures to build a 3-phases inverter. As far as the modulation model is considered, this method can be applied. Indeed, the model of the lines voltage of 3-phases inverter can be obtained by duplicating the line model on the three phases. The load model is then used to obtain the load voltage.

The model obtained is still consistent and also admits an infinity of solutions. Thus, the generalized inverse remains a suitable tool to handle the solution definition. The current work aims at dealing with the maximal rank factorization that exhibits the degrees of freedom of such a system.

Future work will provide experimental results of the proposed approach. The 3-phases inverter of the experimental testbench will be made of three normal T-type switching cells modules (APTGLQ40HR120CT3G from Microsemi in Fig 13). A classical scheme will be used for the control/command layer: the command signals will be send to the switches trough a DSPACE device embedded with FPGA in order to format the signals (i.e. inclusion of the dead time).

REFERENCES

[1] W. C. Rossmann and R. G. Ellis, "Retrofit of 22 pipeline pumping stations with 3000-hp motors and variable-frequency drives", *IEEE Trans. Ind. Appl.*, vol. 34, no. 1, pp. 178-186, Jan./Feb. 1998.

[2] R. Menz and F. Opprecht, "Replacement of a wound rotor motor with an adjustable speed drive for a 1400 kW kiln exhaust gas fan," in *Proc. 44th IEEE IAS Cement Ind. Tech. Conf.*, 2002, pp. 85-93

[3] B. P. Schmitt and R. Sommer, "Retrofit of fixed speed induction motors with medium voltage drive converters using NPC three-level inverter high voltage IGBT based topology," in *Proc. IEEE Int. Symp. Ind. Electron.*, 2001, pp. 746-751.

[4] S. Bernert, "Recent developments of high power converters for industry and traction applications," *IEEE Trans. Power Electron.*, vol. 15, no. 6, pp. 1102-1117, Nov. 2000.

[5] S. Alepuz, S. Busquets-Monge, J. Bordonau, J. Gago, D. Gonzalez, and J. Balcells, "Interfacing renewable energy sources to the utility grid using a three-level inverter," *IEEE Trans. Ind. Electron.*, vol. 53, no. 5, pp. 1504-1511, Oct. 2006.

[6] J. Dixon, L. Moran, R. Rodriguez, and E. Domke, "Reactive power compensation technologies: State-of-the-art review," *Proc. IEEE*, vol. 93, no. 12, pp. 2144-2164, Dec. 2005

[7] Y. Xuan, M. Tian, X. Song, W. Chen and X. Yang, "Design and Implementation of a High Power Three-Level T-Type Inverter for a Photovoltaic System ", 9th International Conference on Power Electronics-ECCE Asia June 1-5, 2015 / 63 Convention Center, Seoul, Korea

[8] M. Schweizer and J. W. Kolar, "High Efficiency Drive System with 3-Level T-Type Inverter", *Proceedings of the 14th IEEE International Power Electronics and Motion Control Conference (ECCE Europe 2011)*, Birmingham, UK, August 30 - September 1, 2011

[9] M. Schweizer, and J. W. Kolar, "Design and Implementation of a Highly Efficient Three-Level T-Type Converter for Low-Voltage Applications", *IEEE Transactions on Power Electronics*, Vol. 28, N. 2, Feb. 2013.

[10] T. D. Nguyen, Q. D. Phan, N. D. Dao, H. N. Nguyen, "The carrier - based PWM method to reduce common-mode voltage for three - level T - type neutral point clamp inverter", *Industrial Electronics and Applications (ICIEA)*, 2014 IEEE 9th Conference on, 2014, Pages: 1549-1554.

[11] U.-M. Choi, J.-S. Lee, K.-B. Lee, "New Modulation Strategy to Balance the Neutral-Point Voltage for Three-Level Neutral-Clamped Inverter Systems", *IEEE Transactions on Energy Conversion*, Vol. 29, N. 1, March 2014.

[12] P-E. Vidal, S. Cailhol, F. Rotella, K. Berkoune, A-M. Llor , M. Fadel, "Generalized inverses applied to Pulse Width Modulation for static conversion : a first study", *EPE'13 ECCE Europe*, Lille, 2013.

[13] H. Shin, K. Lee, J. Choi, S. Seo, J. Lee, "Power loss comparison with different PWM methods for 3L-NPC inverter and 3L-T type inverter", *Electronics and Application Conference and Exposition (PEAC)*, 2014, Pages: 1322-1327.

[14] N. Sathesh, "Advanced T-types NPC - 3 level modules: A new possibility with RB-IGBT's", *Applied Power Electronics Conference 2014, Industry Session*, Fuji Electric Corp. of America.

[15] A. Ben-Israel and T. N. E. Greville, "Generalized Inverses : Theory and Applications", Springer-Verlag, Second edition : 2003

[16] <http://www.scilab.org>: July 2016