



HAL
open science

Comparative Performances Analysis of Different Rotor Types for PMSG Used in Wind Turbine Application

Hacene Mellah, Kamel Eddine Hemsas

► **To cite this version:**

Hacene Mellah, Kamel Eddine Hemsas. Comparative Performances Analysis of Different Rotor Types for PMSG Used in Wind Turbine Application. *International Journal of Advances in Power Systems (IJAPS)*, 2013, 1 (1). hal-01943255

HAL Id: hal-01943255

<https://hal.science/hal-01943255>

Submitted on 3 Dec 2018

HAL is a multi-disciplinary open access archive for the deposit and dissemination of scientific research documents, whether they are published or not. The documents may come from teaching and research institutions in France or abroad, or from public or private research centers.

L'archive ouverte pluridisciplinaire **HAL**, est destinée au dépôt et à la diffusion de documents scientifiques de niveau recherche, publiés ou non, émanant des établissements d'enseignement et de recherche français ou étrangers, des laboratoires publics ou privés.

Comparative Performances Analysis of Different Rotor Types for PMSG Used in Wind Turbine Application

H. Mellah and K.E .Hemsas.

Department of Electrical engineering Ferhat Abbas University, Sétif, Algeria

Laboratoire d'Automatique de Sétif, LAS Ferhat Abbas University, Sétif, Algeria.

has.mel@gmail.com, hemsas_ke_dz@univ-setif.dz

Abstract—PMSG provides a high performance, compact size, light weight, and low noise, without forgetting its simple structure, high thrust, and ease of maintenance, allow replacing steam catapults in the future. Most turbine generators at low wind speed are presented PMSGs, These it has advantages of high efficiency and reliability, since there is no need of external excitation and loss of drivers are removed from the rotor. In this paper, a comparative PMSG performance study's with several rotor topology is presented, each topology rotor has its own permanent magnet structure that is width, thickness and angle. These results are obtained by finite element method (FEM); this approach is a powerful and useful tool to study and design PMSGs, as represented in this paper.

Index Terms—Electrical machine, Design and simulation, Finite element, PMSG, Permanent Magnet, Rotor type, Wind Energy.

I. INTRODUCTION

The development of modern wind power conversion technology has been going on since 1970s, and the rapid development has been seen from 1990s. Various wind turbine concepts have been developed and different wind generators have been built [1].

In specialized literature several types of the machine was developed; we can find a PMSM with internal rotor [2-3] or with external rotor [4], even the comparative studies between the two preceding topology was made [5], Also in [6] it presents a study of interior rotor IG by FE, DC machine [7], external rotor SRM [8], in the references [9-10] we find a study of DFIG internal rotor by FE and external rotor in [11]. Even of the special structure machine like a doubly stator or doubly rotor, this special machine is intended for special applications [12].

Recent studies show a great demand for small to medium rating (up to 20 kW) wind generators for stand-alone generation-battery systems in remote areas. The type of generator for this application is required to be compact and light so that the generators can be conveniently installed at the top of the towers and directly coupled to the WTs [13]. In addition there are several reasons for using variable-speed operation of WTs; the advantages are reduced mechanical stress and optimized power capture. Because of the variable

speed operation, the direct-drive PMSG system can produce 5–10% more energy than the fixed two-speed concept, or 10–15% more than the fixed single-speed concept [14].

II. PMSG IN WIND TURBINE APPLICATION

Compared to a conventional, gearbox coupled WT generator, directly coupled generators has a series of advantages, such as a much reduced size of the overall system, a rather low installation and maintenance cost, flexible control method, quick response to the wind fluctuation and load variations, etc. However, a directly coupled generator needs to have a very low-speed operation to match the WT speed and, at the same time, to produce electricity in a normal frequency range (10-60 Hz) [13].

Compared with electrically excited machines, PMSG have a number of economical and technical advantages, so that they are becoming more attractive for direct-drive WTs, these advantages can be summarised as follows according to literatures [3]:

- ~ Higher efficiency and energy yield,
- ~ No additional power supply for the magnet field excitation,
- ~ Improvement in the thermal characteristics of the PMM due to the absence of the field losses,
- ~ Higher reliability due to the absence of mechanical components such as slip rings,
- ~ Lighter and therefore higher power to weight ratio.

However, PMMs have some disadvantages, which can be summarised as follows:

- ~ Relatively new and unknown technology for applications in larger MW-range
- ~ High cost of PM material,
- ~ Difficulties to handle in manufacture,
- ~ Low material reliability in harsh atmospheric conditions (offshore)
- ~ Demagnetisation of PM at high temperature.

On the other hand, in recent years, the use of PMs is more attractive than before, because the performance of PMs is improving and the cost of PM is decreasing [14].

Currently, Zephyros (currently Harakosan) and Mitsubishi are using this concept in 2 MW WTs in the market.

PMM are not standard off-the-shelf machines and they

allow a great deal of flexibility in their geometry, so that various topologies may be used [14].

We can notice two problems of PMSG used in wind power. First is the inherent cogging torque due to magnet materials naturally attractive force. This kind of torque is bad for operation, especially stopping WT starting and making noise and vibration in regular operation. The other one is the risk of demagnetization because of fault happening and overheating of magnets. This risk is very dangerous and the cost for replacing bad magnets is much higher than the generator itself [3].

III. PMSG DESIGN METHODOLOGY

Traditionally, the study and design of PMSGs is based on the equivalent magnetic circuit method (EMCM). The EMCM is of advantages of simplicity and fast computation, but its disadvantage is also marked: it relies too much on empirical design experience, such as flux leakage coefficient, armature reaction factor, etc. Meanwhile, under certain circumstances, EMCM is not competent for the analysis and design of PMSGs. For example, EMCM cannot be employed to study the cogging torque of PMSGs with fractional stator slots [15]. Numerical methods, such as finite-element analysis (FEA), have been extensively used in study and design PMSGs [11-15]. Furthermore, owing to its precision and simplicity, the two-dimensional (2-D) FEM has approximately dominated the FEM study of PMSGs. By using FEM, many design curves and data, such as the PMSGs' output voltage, no-load leakage flux coefficient, and cogging torque etc., can be obtained and used to design PMSGs[11]. In addition, many commercially available computer-aided design (CAD) packages for PM motor designs, such as SPEED, Rmxprt, and flux2D, require the designer to choose the sizes of magnets. The performance of the PM motor can be made satisfactory by constantly adjusting the sizes of magnets and/or repeated FEA analyses [10].

IV. PMSG GEOMETRIC DIMENSION AND DESIGN PARAMETERS

Our goal is to see and analysis the effects of the rotors topology on the designed generator performances, and accurately the permanent magnets such as PM positioning, thickness, width and bending angle, to properly isolate the interaction PMSG phenomena, all machines are designed with the same stator in terms of size, dimensions and materials, this approach which makes it possible to compare machines together.

A. Stator Topology

The operation principle of electric machines is based on the interaction between the magnetic fields and the currents flowing in the windings of the machine.

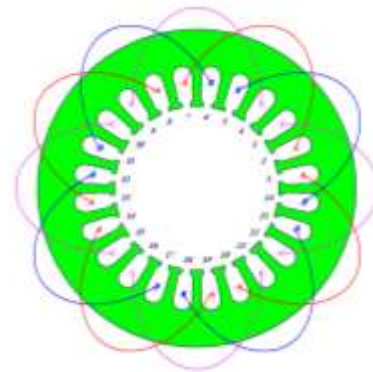

Fig. 1. Stator and coil structure of all designed generators.

The following table shows some common rated values, geometric parameters of all prototype PMSGs.

TABLE I
SOME COMMON RATED VALUES, GEOMETRIC PARAMETERS OF ALL PMSG

Rated Voltage (V)	120
Outer Diameter of Stator (mm)	120
Inner Diameter of Stator (mm)	75
Number of Stator Slots	24
Number of Stator Slots	24
Length of Stator Core (Rotor) (mm)	65
Stacking Factor of Stator Core	0.95
Stacking Factor of Iron Core	0.95
Frictional Loss (W)	12
Operating Temperature (\hat{C})	75

The following figure shows the b-h non linear characteristic of the steel core both for stator and rotor.

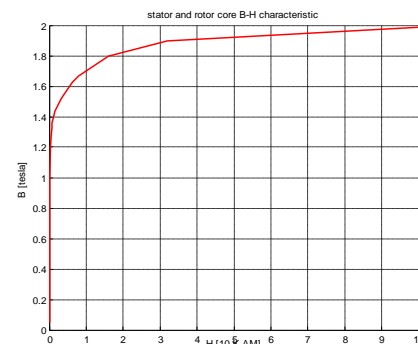

Fig. 2. stator and rotor core B-H characteristic

B. Rotor Topologies

In this paper our study is carried out for various rotor topologies. They are listed below:

The rotor types under study, depicted in Fig. 3, are:

Type 1: PMSG with a rotor with surface mounted thinnest magnets with a vertical edge (SMTV-PMSG).

Type 2: PMSG with a rotor surface mounted thinnest magnets with bending angle edge (SMTB-PMSG).

Type 3: PMSG with a rotor surface mounted thickness magnets with bending angle edge (SMB-PMSG).

type4: PMSG with a rotor with radial arranged internal magnets (RI-PMSG).

Type 5: PMSG with a rotor with internal magnets (I-PMSG).

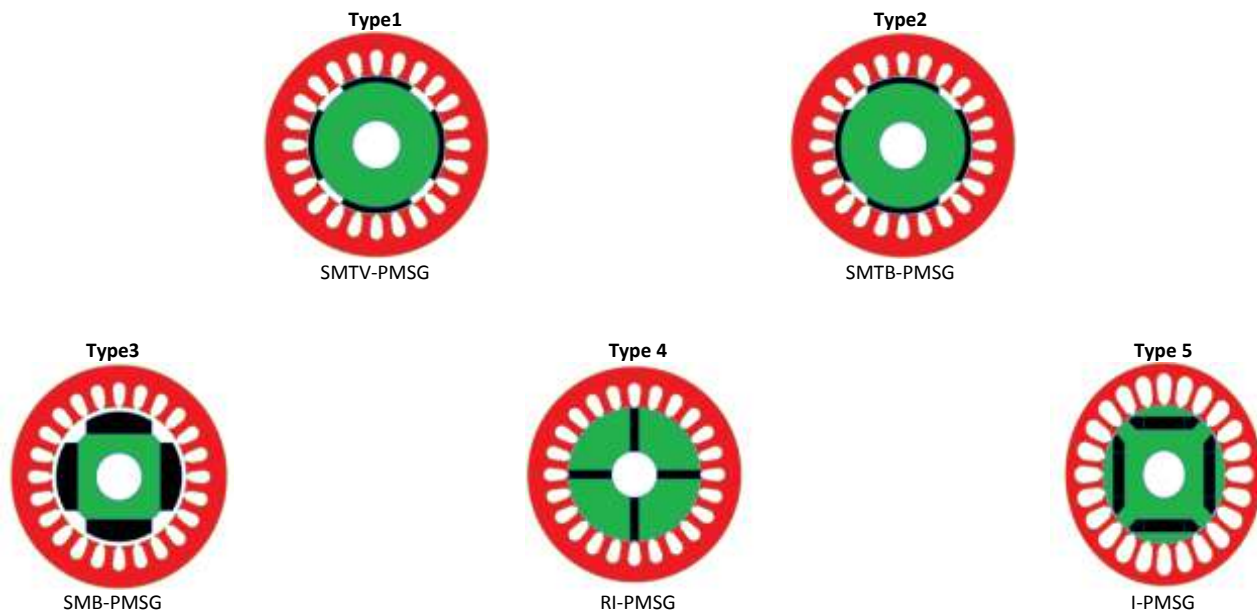

Fig. 3. Several rotor used in designed PMSG

Rotational Machine Expert (RMxprt) is an interactive software package used for designing and analyzing electrical machines, is a module of Ansoft Maxwell 12.1 [10].

The following figure shows ¼ 3D of PMSG prototype with rotor type1.

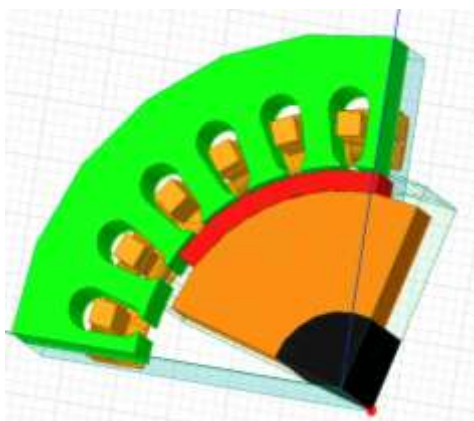

Fig. 4. 3D view of the PMSG designed with rotor type 2.

V. SIMULATION RESULTS

The FEA model of electromagnetic field is built by Maxwell12D, This simulation is obtained by Terra pc (QuadroFX380, i7 CPU, 3.07 GHZ, 8 CPU, 4 G RAM), and the simulation time is take some hours. Our model of PMSG used in Maxwell environment has 19699 triangles.

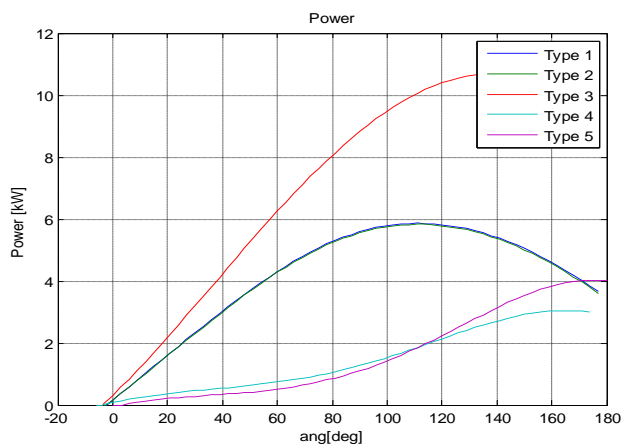

Fig. 5. Power vs angle degree for several PMSG rotor type.

Fig. 5 illustrate the PMSG power for several rotor type, the maximum PMSG power produced by the two rotors 4 and 5 do not exceed 4kw, however, the use of the rotor type 1 or 2 improve the power almost than 150%, the magnificent of all rotor cases is the operation of PMSG with rotor type 3; where the power produced by PMSG using the rotor type 3 is almost three times the power in case 2.

We can say that the type rotor 3 is suitable designed to give maximum power compared to all rotor.

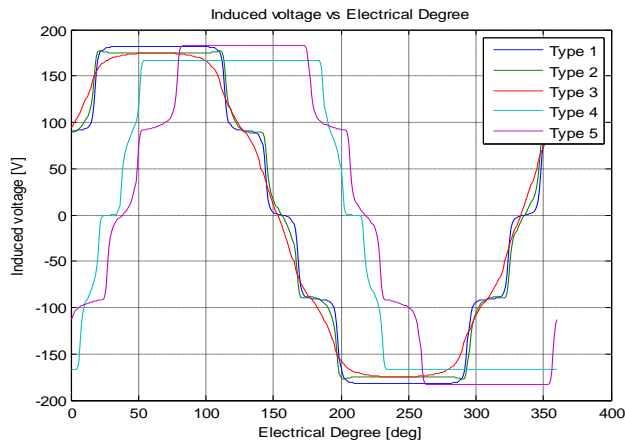

Fig. 6. Induced phase voltage vs electrical degree for several PMSG rotor type.

Fig. 6 illustrates the induced phase voltage with respect to the electrical degree for several PMSG rotor topologies, by comparison the rotor type 1 and type 5 give the same induced voltage of value 182V, a small decrease of 7V ($\approx 4\%$) can be noticed for both cases 2 and 3 rotor topologies, the choice to use the rotor type 2 or type 3 make the PMSG produce exactly 175V.

In the fourth case the PMSG produce only 167V, so a decrease of more than 8% compared to the case 1 and 5.

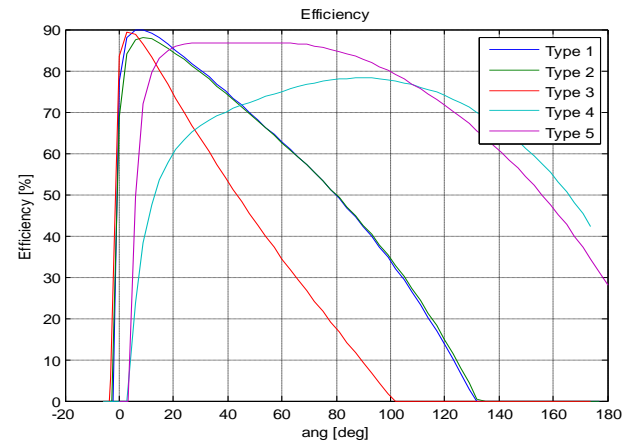

Fig. 7. Efficiency with respect to angle degree for several PMSG rotor type.

Fig. 7 illustrates the efficiency with respect vs angle degree for several PMSG rotor topologies, the curvature can be divided in two categories; the first one is slim curves with a significant peaks the first categories include the rotor type 1, type and type 3, the efficiency are respectively 90%, 89.31% and 88.06%.

The second one is wide curves with a small peak this characteristic is really corresponding to the both rotor type cases 4 and 5, the maximum of efficiency are 86.65% and 78.23%.

By comparison the first category has an important efficiency greater than 70% but not for all rotor angles just for the first 40 degree, however the second hasn't an important peak but guard the efficiency up 70% for more than 120 degree.

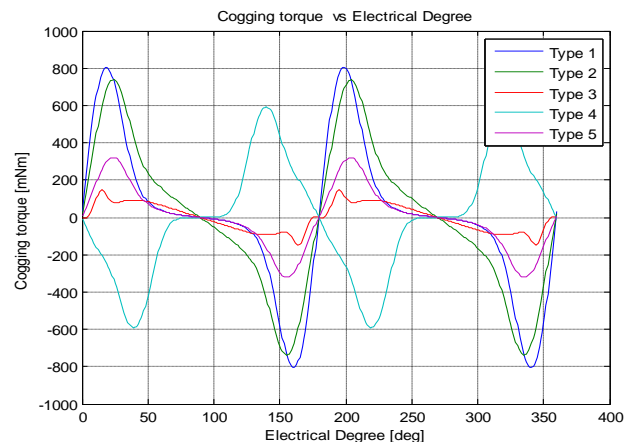

Fig. 8. Cogging torque vs electrical degree for several PMSG rotor type.

In Fig. 8, the computed cogging torque is compared for several rotor types, we can see that the 1, 2 and 4 rotor type produce a great peak 0,8 Nm, however a small cogging torque is remarked in the both rotor type case 3 and 5 the minimum value is 0,2 Nm, in all rotor cases the curvature are similar.

We can say that the SMB-PMSG is suitable designed to give minimum cogging torque compared to all rotor type.

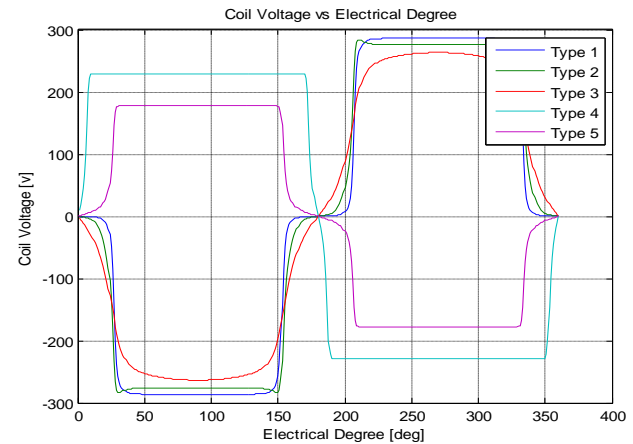

Fig. 9. One coil voltage vs electrical degree for several PMSG rotor type.

Fig. 9. Show the one coil voltage vs electrical degree for several PMSG rotor types, the rotor type 1, 2 and 3 have almost the same curvature, but the rotor type 4 and 5 gives a reverse voltage with substantially small amplitude.

Fig. 10. Show the flux density vs electrical degree for several PMSG rotor topologies, the rotor type 1, 2 and 3 have almost the same curvature, but the rotor type 4 and 5 gives a reverse curve with substantially small amplitude.

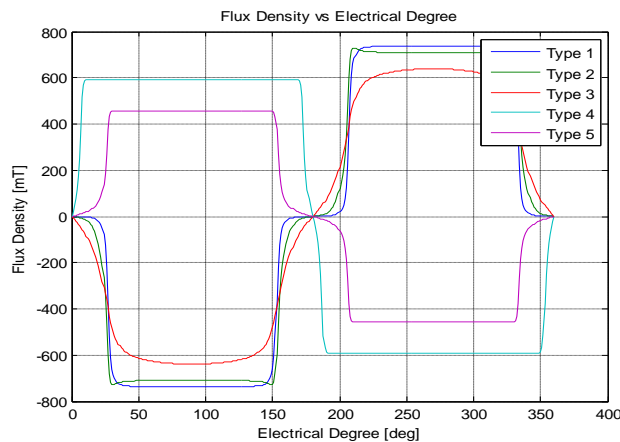

Fig. 10. Flux density distribution with respect to electrical degree for several PMSG rotor type.

VI. CONCLUSION

Finite element analysis (FEA) is a frequently used method for analysis of electromechanical converters. As a numerical analysis method, FEA allows for including any practical material, external excitation, inclusion of motion, and nonlinear effects such as magnetic saturation and eddy current effects.

A several PMSG rotor types are presented such as SMTV-PMSG, SMTB-PMSG, SMB-PMSG, RI-PMSG and I-PMSG, designed, modeled, solved and some simulation results is given and commented.

This work is the necessary preparations for design and development high reliability and high security of PMSG applications.

It can be seen that each structure has these advantages and these disadvantages, so the need of optimization is a mandatory step for optimal results and maximized the most PMSG performances, so in the future work we think to use fuzzy logic or genetic algorithms.

REFERENCE

- [1] H. Li, Z. Chen, "Overview of different wind generator systems and their comparisons", IET, Renewable Power Generation, vol. 2, pp. 123–138, 2008.
- [2] J. Krottsch, B. Piepenbreier, "Radial Forces in External Rotor Permanent Magnet Synchronous Motors With Non-Overlapping Windings", IEEE Transactions on Industrial Electronics, vol. 59, pp. 2267–2276, May 2012.
- [3] H. Mellah, K. E. Hemsas, "Simulations Analysis with Comparative Study of a PMSG Performances for Small WT Application by FEM," International Journal of Energy Engineering, vol.3, no 2, pp. 55–64, 2013.
- [4] P. sergeant, F. de belie, J. melkebeek, "Rotor geometry design of an interior permanent-magnet synchronous machine for more accurate sensorless control", electrical machines (ICEM), xix international conference on, pp.1–6, 6–8 Sept. 2010.
- [5] İ. Tarimer, C. Ocak, "Performance Comparison of Internal and External Rotor Structured Wind Generators Mounted from Same

Permanent Magnets on Same Geometry", Electronics and Electrical Engineering, vol.8, Issue. 90, pp. 67–72, 2009.

[6] S. Seman, "Transient Performance Analysis of Wind-Power Induction Generators", Doctoral theses, Helsinki University of Technology, 2006.

[7] Z. Huiqing, C. Shiyuan, "Finite Element Analysis on Small External Rotor Brushless DC Motor", China National Knowledge, Micromotors, 2012.

[8] H. Torkaman, E. Afjei, A. Gorgani, N. Faraji, H. Karim, N. Arbab, "External rotor SRM with high torque per volume: design, analysis, and experiments", Springer-Verlag, Electrical Engineering, November 2012.

[9] D. Xiaotian, Z. Xinyan1, Z. Jun, W. Houjun, HE. Shan, "Finite Element Based Electromagnetic Field Simulation and Analysis of Doubly Fed Induction Generator", China National Knowledge, Power System Technology, 2012.

[10] H. Mellah, K.E. Hemsas, "Design and simulation analysis of outer stator inner rotor DFIG by 2d and 3d finite element methods", International Journal of Electrical Engineering and Technology, vol. 3, Issue. 2, pp. 457–470, July–Sept 2012.

[11] H. Mellah and K. E. Hemsas, "Design and Analysis of an External-Rotor Internal-Stator Doubly Fed Induction Generator for Small Wind Turbine Application by Fem," International Journal of Renewable and Sustainable Energy. vol. 2, no. 1, pp. 1–11, 2013.

[12] K.T.Chau, Y.B. Li, J.Z.Jiang, C. Liu, "Design and Analysis of a Stator-Doubly-Fed Doubly-Salient Permanent-Magnet Machine for Automotive Engines", IEEE Transactions on Magnetics, vol. 42, Issue. 10, pp 3470 – 3472, 2006.

[13] İ. Tarimer, C. Ocak, Performance Comparison of Internal and External Rotor Structured Wind Generators Mounted From Same Permanent Magnets on Same Geometry, Electronics And Electrical Engineering, Sins 1392 – 1215 2009.

[14] H. Li, Z. Chen, Overview of different wind generator systems and their comparisons, Renewable Power Generation, IET 2007.

[15] Z. guo, L. chang, FEM Study on Permanent Magnet Synchronous Generators for Small Wind Turbines, IEEE 2005.