



**HAL**  
open science

## Mechanical properties of “ Flexure Wood ”

Benjamin Niez, Jana Dlouha, Evelyne Toussaint, Joseph Gril, Bruno Moulia,  
Eric Badel

► **To cite this version:**

Benjamin Niez, Jana Dlouha, Evelyne Toussaint, Joseph Gril, Bruno Moulia, et al.. Mechanical properties of “ Flexure Wood ”. 7e Journées du GDR 3544 Sciences du bois, Nov 2018, Cluny, France. GDR 3544, pp.320, 2018, 7e Journées du GDR 3544 Sciences du bois. hal-01939979

**HAL Id: hal-01939979**

**<https://hal.science/hal-01939979v1>**

Submitted on 29 Nov 2018

**HAL** is a multi-disciplinary open access archive for the deposit and dissemination of scientific research documents, whether they are published or not. The documents may come from teaching and research institutions in France or abroad, or from public or private research centers.

L'archive ouverte pluridisciplinaire **HAL**, est destinée au dépôt et à la diffusion de documents scientifiques de niveau recherche, publiés ou non, émanant des établissements d'enseignement et de recherche français ou étrangers, des laboratoires publics ou privés.



## Wood: a complex material resulting from tree acclimation to growing conditions

Wood ensures the mechanical stability of the trunk and branches. Its formation is impacted by windy environments: living cells sense mechanical strains and modify the formation of wood accordingly in terms of quantity and quality: these biological responses are called "Thigmomorphogenesis".

We bent young poplars three times a day, five days per week during six months. When a stem is bent, wood endures compressive and/or tensile stresses. Our objective is to determine the impact of these growing conditions on the mechanical properties of wood.

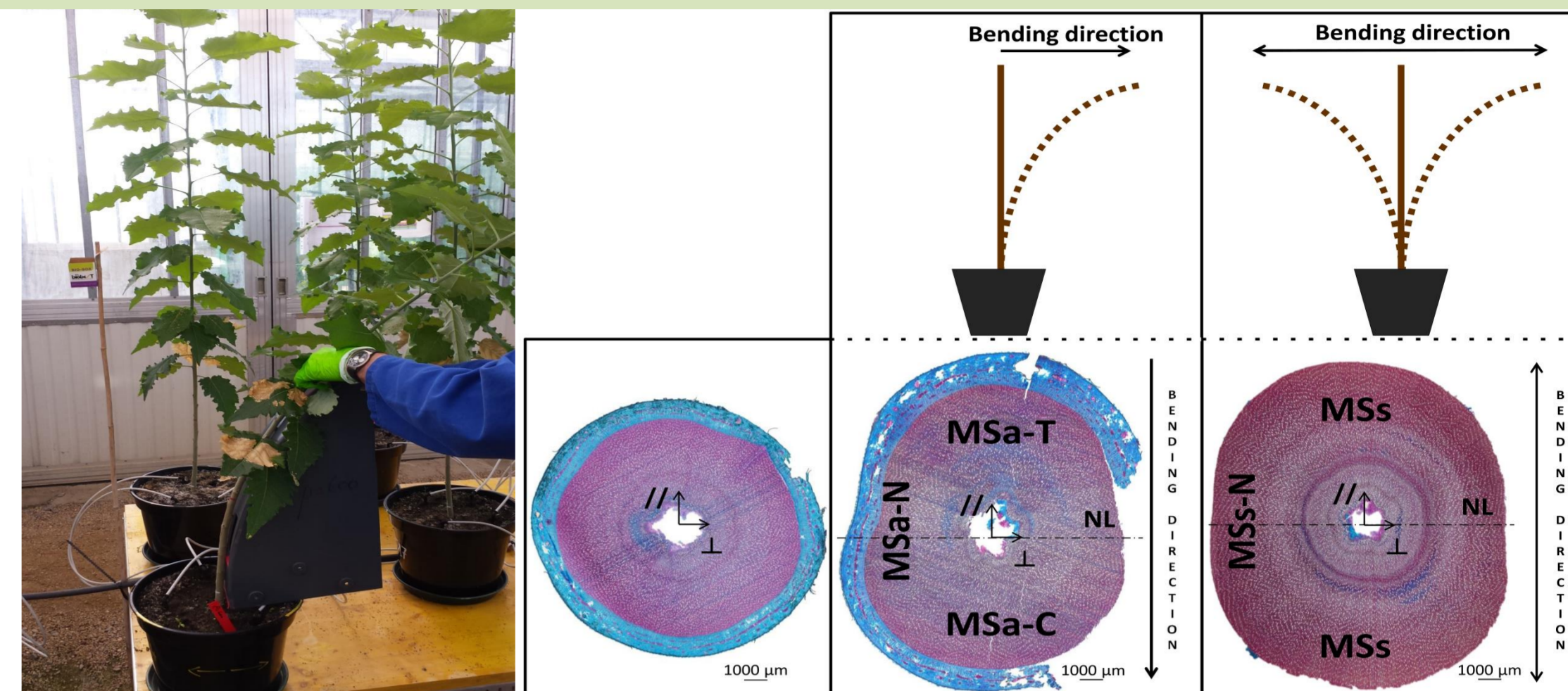

## Mechanical behaviour of the stem

Test in the direction of bending treatments //:

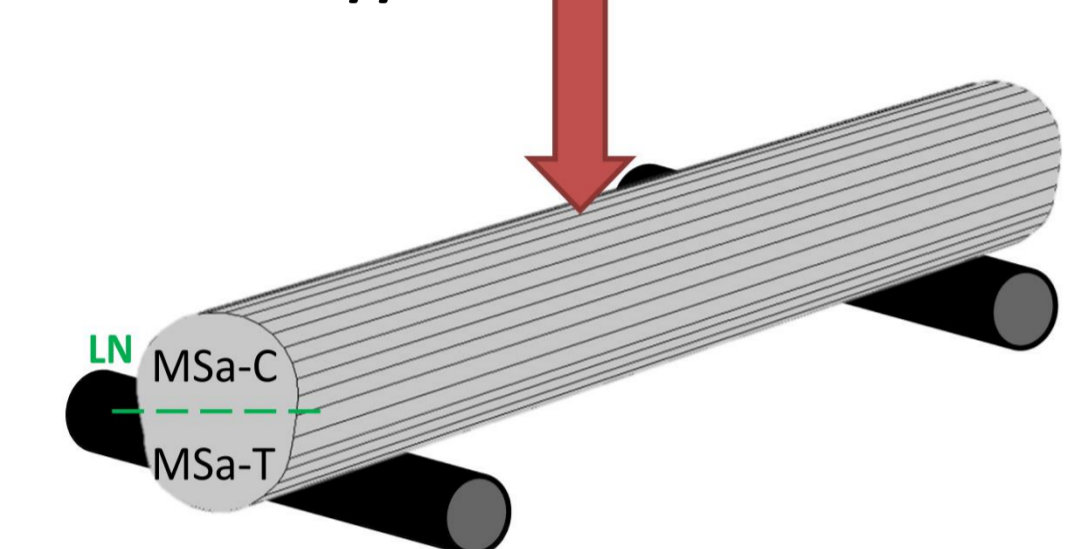

Test perpendicular to the direction of bending treatments ⊥:

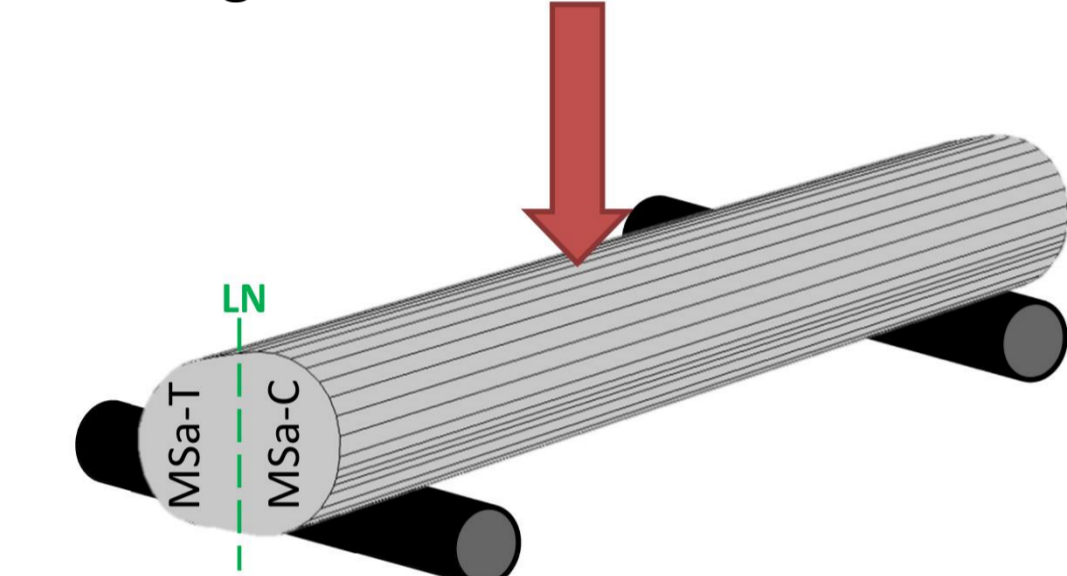

Control (C)	
MSa //	MSa: Mechanical Stimulation (asymmetric)
MSa ⊥	
MSs //	MSs: Mechanical Stimulation (symmetric)
MSs ⊥	

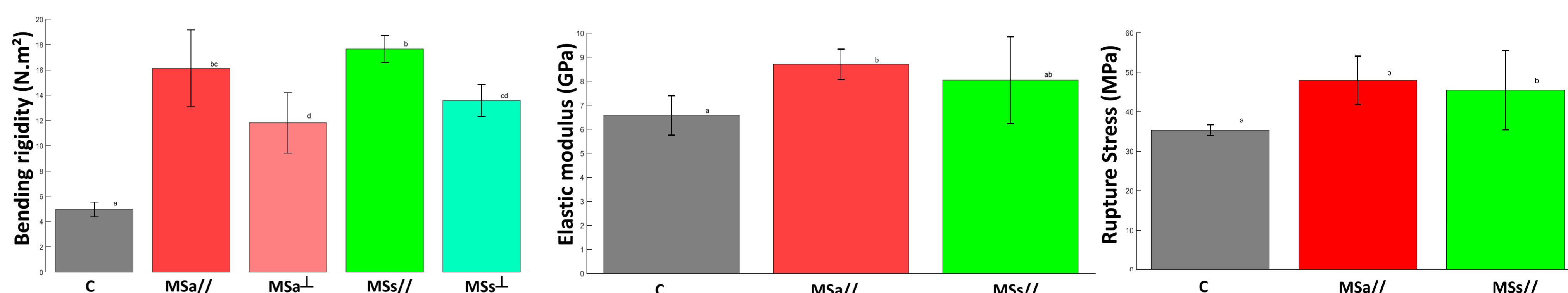

### Main results:

- Bending treatments dramatically enhance the stem bending rigidity (**x3.3** for MSa// and **x3.56** for MSs//)
- Asymmetrical bending increase the elastic modulus (**+32.3%** for MSa//)
- Bending treatments increase the MOR (**+35.8%** for MSa// and **+28.8%** for MSs//)

=> **Mechanical benefit of tree acclimation to bending**

## Mechanical behaviour of wood tissue

### Material and Methods

#### 3 points micro-bending test:

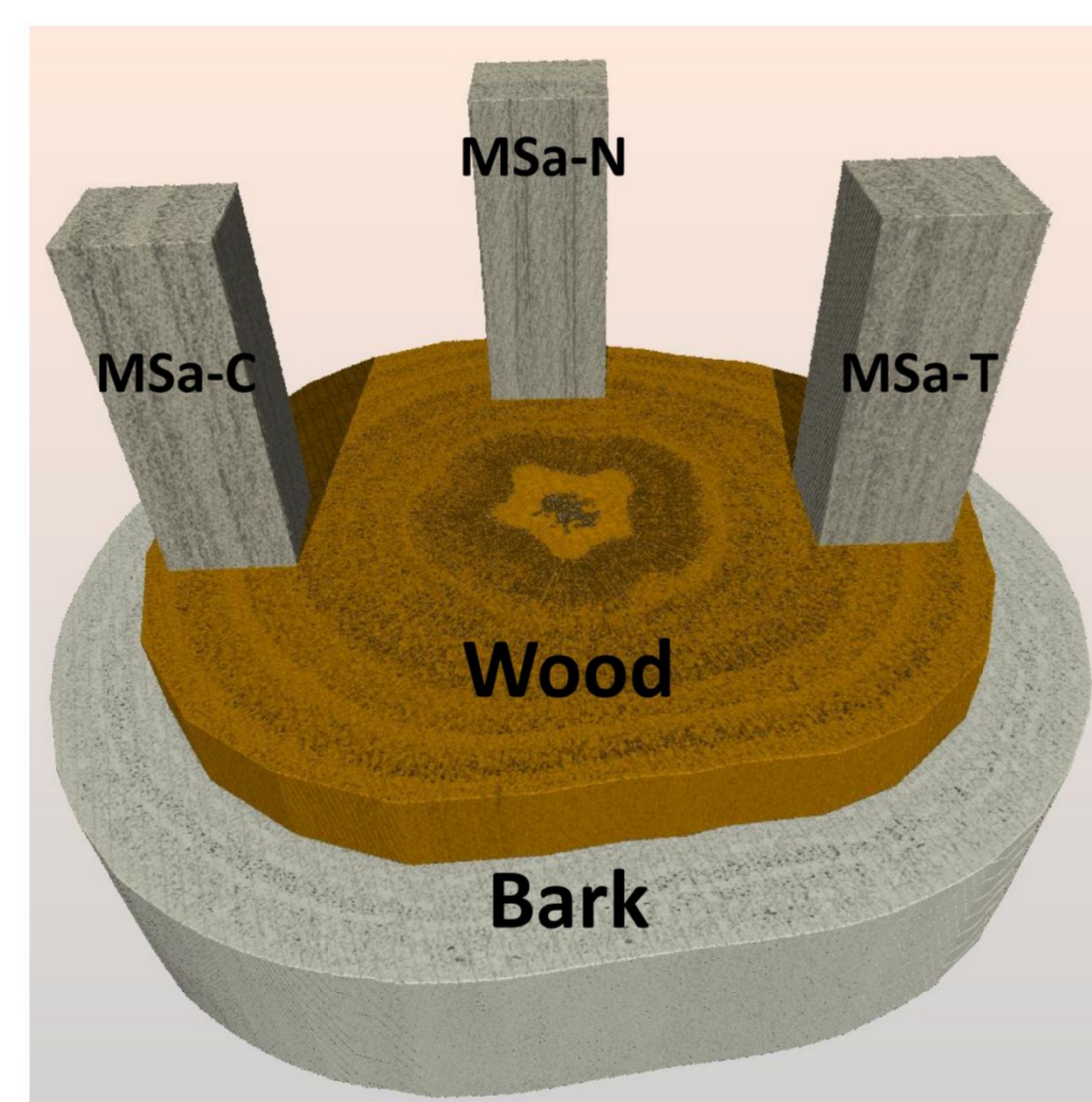
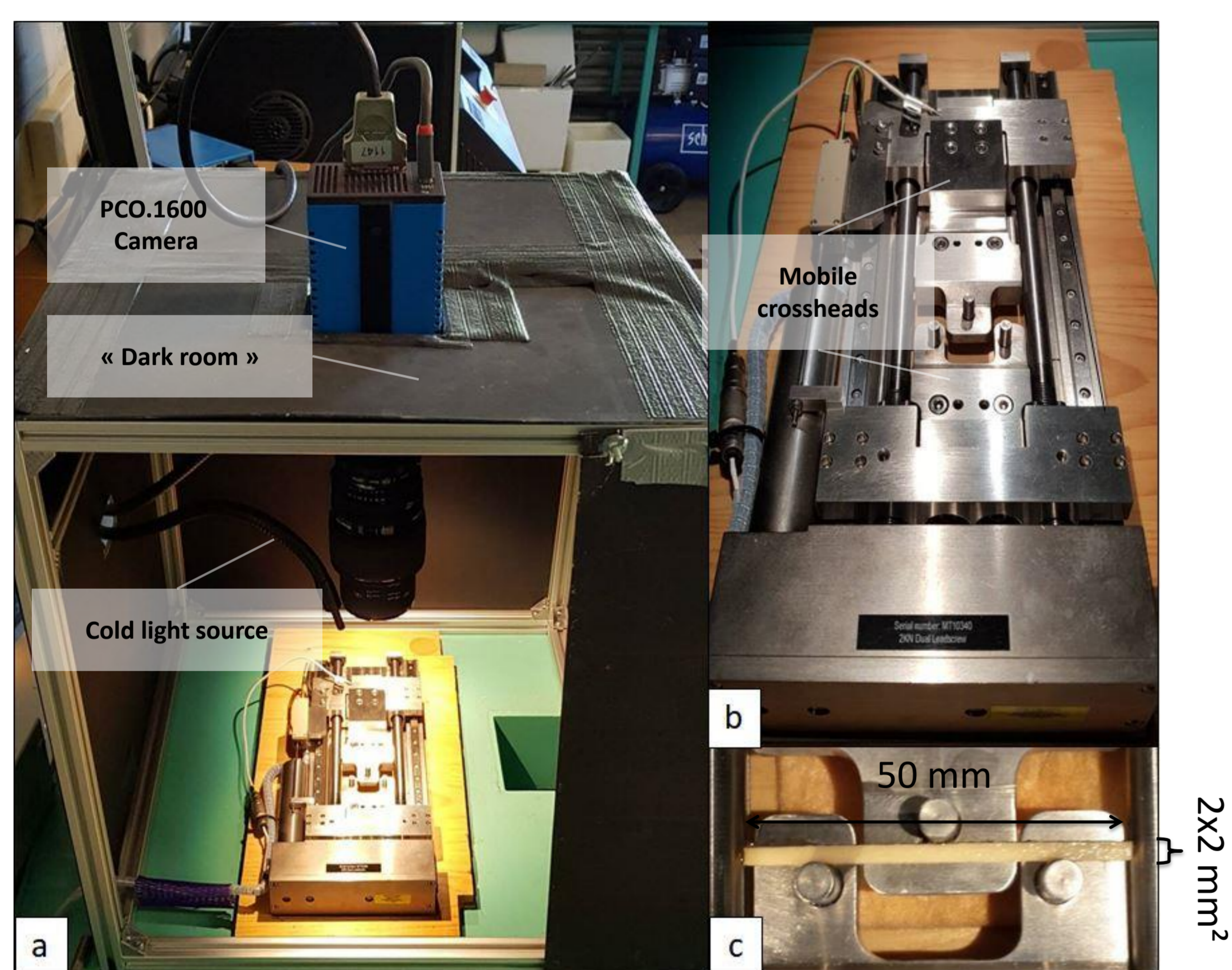

Control (C)	
MSa-C	-C: wood formed under Compressive stresses
MSa-T	-T: wood formed under Tensile stresses
MSa-N	-N: wood formed in the Neutral area
MSs	
MSs-N	

### Main results

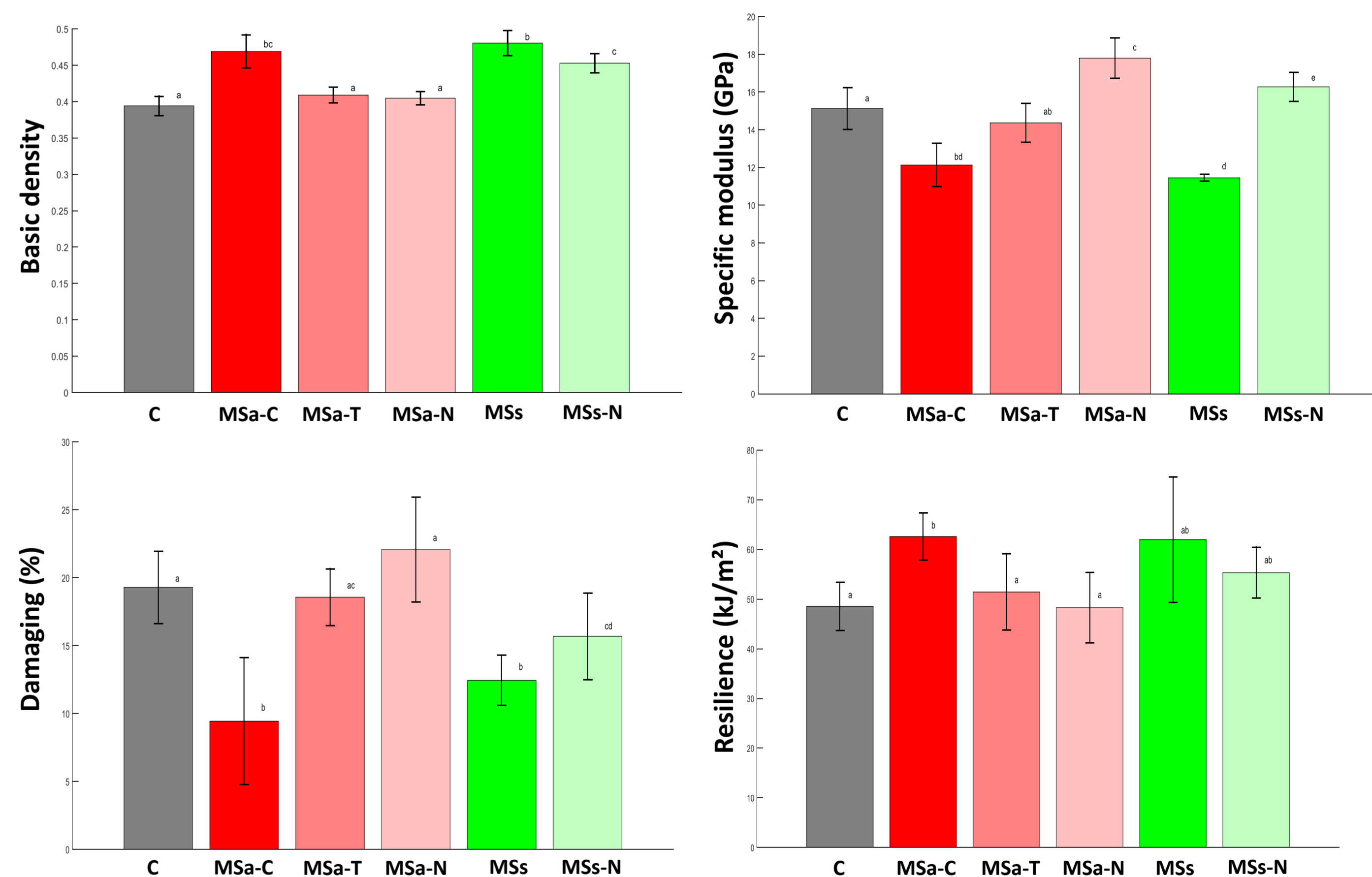

### Main results:

- **Increase of the basic density** of wood formed under compressive stresses MSa-C (**+19%**) and of "flexure wood" MSs (**+22%**) compared to control wood C.
- **Decrease of specific modulus** of wood formed under compressive stresses MSa-C (**-20%**) and of "flexure wood" MSs (**-24%**)
- **High decrease of damaging** for wood formed under compressive stresses MSa-C (**-51%**) and for "flexure wood" MSs (**-36%**)
- **Increase of mechanical resilience** of wood formed under compressive stresses (MSa-C) by **+29%**

### Key message:

=> **Compressive strains (risky strains for wood) drive the mechanical acclimation of wood to bending treatments**

=> **Wood acclimation to bending provides a mechanical benefit for trees sustainability in fluctuating mechanical environments**

#### Dynamic rupture (resilience):

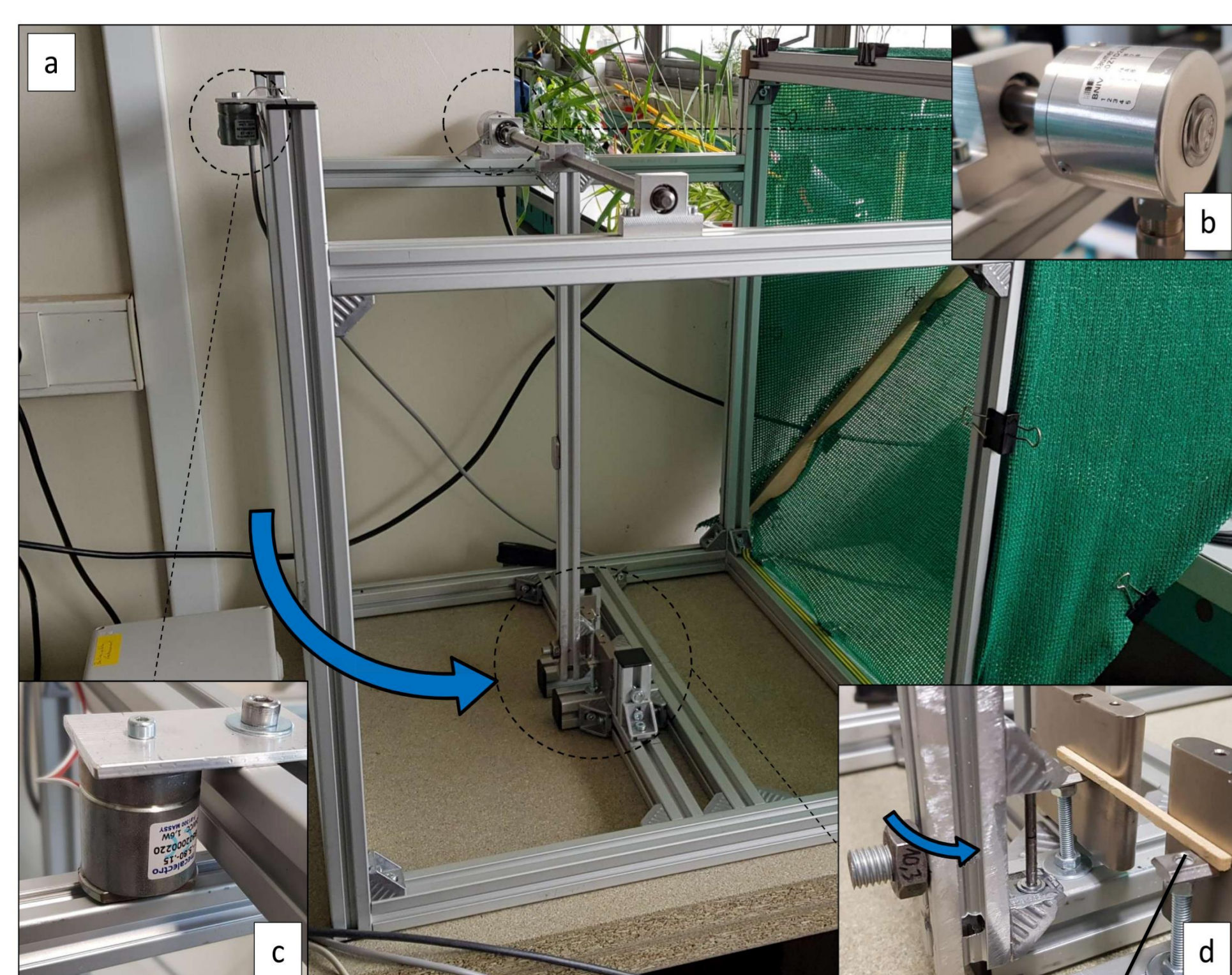

Sample: 2x2x70 mm (RxTxL)