

# Walls in notched ferromagnetic nanowires

Gilles Carbou

Université de Pau et des Pays de l'Adour  
Laboratoire de Mathématiques et de leurs Applications,  
UMR CNRS 5142

**Joint works with David Sanchez (INSA-Toulouse)**

**Analysis of singular patterns in variational models**

**June 18 to 22, 2018, Toulouse**

- 1 Physical Context
- 2 1d Model for ferromagnetic nanowires
- 3 Walls in constant-section wire
- 4 Wall configurations for infinite nanowire with one notch
- 5 Wire with several notches
- 6 Applied Magnetic Field and Electric Current Effects

# Motivation : Data storage in ferromagnetic nanowires

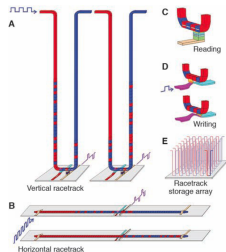

S. Parkin, M. Hayashi, L. Thomas, *Magnetic Domain-Wall Racetrack Memory*, *Science* **320** (2008)

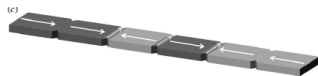

G. Hrkac, J. Dean and D. A. Allwood, *Nanowire spintronics for storage class memories and logic*, *Phil. Trans. R. Soc. A* (2011) **369**

# Ferromagnetic materials

## Properties

- Spontaneous magnetization
- Magnetic field generated by the magnetization
- Formation of domains and domain walls

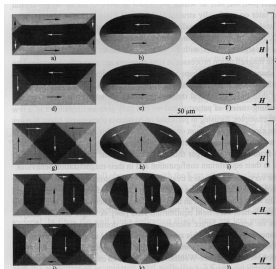
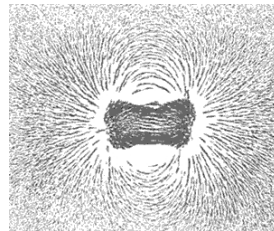

A. Aharoni, Introduction to the Theory of Ferromagnetism, Oxford University Press, 1996

## Industrial Applications

- Electromagnets
- Transformers
- Radar absorbing paints
- Mobile phones
- Modern Recording Devices

# Data storage in ferromagnetic nanowires

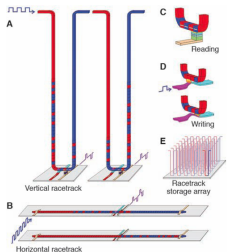

S. Parkin, M. Hayashi, L. Thomas, *Magnetic Domain-Wall Racetrack Memory*, *Science* **320** (2008)

- Bits encoded by the direction of the magnetization
- Stabilization of walls positions by notches

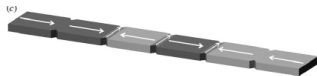

G. Hrkac, J. Dean and D. A. Allwood, *Nanowire spintronics for storage class memories and logic*, *Phil. Trans. R. Soc. A* (2011) **369**

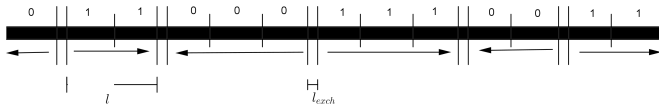

Stuart S. P. Parkin, Masamitsu Hayashi, Luc Thomas, *Magnetic Domain-Wall Racetrack Memory*, *Science* **320** (2008)

- 3d devices for the storage of numerical data
- Fast access

For data storage :

- DW seems to be pinned in the notches (reliability of the storage)
- DW depinning by magnetic field : data recording
- DW depinning by application of an electric current : data reading

## Goals

- Obtention and justification of equivalent simpler 1d-models for nanowires
- Description of walls configurations and walls dynamics
- Effects of notches on walls stability
- DW depinning

For data storage :

- DW seems to be pinned in the notches (reliability of the storage)
- DW depinning by magnetic field : data recording
- DW depinning by application of an electric current : data reading

## Goals

- Obtention and justification of equivalent simpler 1d-models for nanowires
- Description of walls configurations and walls dynamics
- Effects of notches on walls stability
- DW depinning

- 1 Physical Context
- 2 1d Model for ferromagnetic nanowires**
- 3 Walls in constant-section wire
- 4 Wall configurations for infinite nanowire with one notch
- 5 Wire with several notches
- 6 Applied Magnetic Field and Electric Current Effects



## Magnetic Moment

- Magnetic domain :  $\Omega \subset \mathbb{R}^3$
- Magnetization described by the magnetic moment  $m : \mathbb{R}_t^+ \times \Omega_x \rightarrow \mathbb{R}^3$

$$|m(t, x)| = 1 \text{ p. p.}$$

- Constitutive Relation :  $B = H + m$

## Landau-Lifschitz Equation

$$\frac{\partial m}{\partial t} = -m \times \mathcal{H} - m \times (m \times \mathcal{H})$$

$$\mathcal{H} = -\partial_m \mathcal{E}(m) = A\Delta m + h_d(m) + \psi(m) + H_a$$

$$\mathcal{E}(m) = \frac{A}{2} \int_{\Omega} |\nabla m|^2 + \frac{1}{2} \int_{\mathbb{R}^3} |h_d(m)|^2 + \int_{\Omega} \Psi(m) - \int_{\Omega} m \cdot H_a$$

$$\text{curl } h_d(m) = 0, \quad \text{div } (h_d(m) + \bar{m}) = 0$$

## Magnetic Moment

- Magnetic domain :  $\Omega \subset \mathbb{R}^3$
- Magnetization described by the magnetic moment  $m : \mathbb{R}_t^+ \times \Omega_x \rightarrow \mathbb{R}^3$

$$|m(t, x)| = 1 \text{ p. p.}$$

- Constitutive Relation :  $B = H + m$

## Landau-Lifschitz Equation

$$\frac{\partial m}{\partial t} = -m \times \mathcal{H} - m \times (m \times \mathcal{H})$$

$$\mathcal{H} = -\partial_m \mathcal{E}(m) = A \Delta m + h_d(m) + \psi(m) + H_a$$

$$\mathcal{E}(m) = \frac{A}{2} \int_{\Omega} |\nabla m|^2 + \frac{1}{2} \int_{\mathbb{R}^3} |h_d(m)|^2 + \int_{\Omega} \Psi(m) - \int_{\Omega} m \cdot H_a$$

$$\text{curl } h_d(m) = 0, \quad \text{div } (h_d(m) + \bar{m}) = 0$$

## Magnetic Moment

- Magnetic domain :  $\Omega \subset \mathbb{R}^3$
- Magnetization described by the magnetic moment  $m : \mathbb{R}_t^+ \times \Omega_x \rightarrow \mathbb{R}^3$

$$|m(t, x)| = 1 \text{ p. p.}$$

- Constitutive Relation :  $B = H + m$

## Landau-Lifschitz Equation

$$\frac{\partial m}{\partial t} = -m \times \mathcal{H} - m \times (m \times \mathcal{H})$$

$$\mathcal{H} = -\partial_m \mathcal{E}(m) = A \Delta m + h_d(m) + \psi(m) + H_a$$

$$\mathcal{E}(m) = \frac{A}{2} \int_{\Omega} |\nabla m|^2 + \frac{1}{2} \int_{\mathbb{R}^3} |h_d(m)|^2 + \int_{\Omega} \Psi(m) - \int_{\Omega} m \cdot H_a$$

$$\text{curl } h_d(m) = 0, \quad \text{div } (h_d(m) + \bar{m}) = 0$$

## Magnetic Moment

- Magnetic domain :  $\Omega \subset \mathbb{R}^3$
- Magnetization described by the magnetic moment  $m : \mathbb{R}_t^+ \times \Omega_x \rightarrow \mathbb{R}^3$

$$|m(t, x)| = 1 \text{ p. p.}$$

- Constitutive Relation :  $B = H + m$

## Landau-Lifschitz Equation

$$\frac{\partial m}{\partial t} = -m \times \mathcal{H} - m \times (m \times \mathcal{H})$$

$$\mathcal{H} = -\partial_m \mathcal{E}(m) = A \Delta m + h_d(m) + \psi(m) + H_a$$

$$\mathcal{E}(m) = \frac{A}{2} \int_{\Omega} |\nabla m|^2 + \frac{1}{2} \int_{\mathbb{R}^3} |h_d(m)|^2 + \int_{\Omega} \psi(m) - \int_{\Omega} m \cdot H_a$$

$$\text{Uniaxial Anisotropy : } \Psi(m) = -\frac{1}{2} (m \cdot \xi)^2 \text{ and } \psi(m) = -\partial_m \Psi = (m \cdot \xi) \xi$$

## Magnetic Moment

- Magnetic domain :  $\Omega \subset \mathbb{R}^3$
- Magnetization described by the magnetic moment  $m : \mathbb{R}_t^+ \times \Omega_x \rightarrow \mathbb{R}^3$

$$|m(t, x)| = 1 \text{ p. p.}$$

- Constitutive Relation :  $B = H + m$

## Landau-Lifschitz Equation

$$\frac{\partial m}{\partial t} = -m \times \mathcal{H} - m \times (m \times \mathcal{H})$$

$$\mathcal{H} = -\partial_m \mathcal{E}(m) = A \Delta m + h_d(m) + \psi(m) + H_a$$

$$\mathcal{E}(m) = \frac{A}{2} \int_{\Omega} |\nabla m|^2 + \frac{1}{2} \int_{\mathbb{R}^3} |h_d(m)|^2 + \int_{\Omega} \Psi(m) - \int_{\Omega} m \cdot H_a$$

Applied magnetic field :  $H_a$

## Magnetic Moment

- Magnetic domain :  $\Omega \subset \mathbb{R}^3$
- Magnetization described by the magnetic moment  $m : \mathbb{R}_t^+ \times \Omega_x \rightarrow \mathbb{R}^3$

$$|m(t, x)| = 1 \text{ p. p.}$$

- Constitutive Relation :  $B = H + m$

## Landau-Lifschitz-Gilberg Equation

$$\frac{\partial m}{\partial t} - m \times \frac{\partial m}{\partial t} = -2m \times \mathcal{H}$$

$$\mathcal{H} = -\partial_m \mathcal{E}(m) = A\Delta m + h_d(m) + \psi(m) + H_a$$

$$\mathcal{E}(m) = \frac{A}{2} \int_{\Omega} |\nabla m|^2 + \frac{1}{2} \int_{\mathbb{R}^3} |h_d(m)|^2 + \int_{\Omega} \Psi(m) - \int_{\Omega} m \cdot H_a$$

# 1d model of wire with non constant cross section

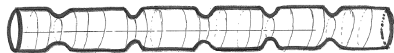

$$\Omega_\eta = \{(x_1, x_2, x_3), x_1 \in \mathbf{I}, (x_2)^2 + (x_3)^2 < \eta^2(\rho(x_1))^2\}$$

Radius of the cross section :  $\rho$

- $\rho : \mathbf{I} \rightarrow \mathbb{R}^{*+}, \mathcal{C}^\infty,$
- $0 < \rho_{\min} \leq \rho(x_1) \leq 1$
- $\mathbf{s}(x_1) = \pi(\rho(x_1))^2$

Weak Formulation :

$$\int_{[0, T] \times \Omega_\eta} \left( \frac{\partial m}{\partial t} - m \times \frac{\partial m}{\partial t} \right) \cdot \Psi = 2 \int_{[0, T] \times \Omega_\eta} \sum_{i=1}^3 m \times A \frac{\partial m}{\partial x_i} \cdot \frac{\partial \Psi}{\partial x_i} - 2 \int_{[0, T] \times \Omega_\eta} m \times H_d(m) \cdot \Psi.$$

- rescaling : fix domaine  $\Omega_1 = \{(x_1, \tilde{x}_2, \tilde{x}_3), x \in \mathbf{I}, (\tilde{x}_2)^2 + (\tilde{x}_3)^2 < (\rho(x_1))^2\}$
- $\eta \rightarrow 0$  in the weak formulation with  $\Psi(t, x_1, \tilde{x}_2, \tilde{x}_3) = \varphi(t, x_1)$

# 1d model of wire with non constant cross section

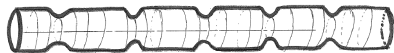

$$\Omega_\eta = \{(x_1, x_2, x_3), x_1 \in \mathbf{I}, (x_2)^2 + (x_3)^2 < \eta^2(\rho(x_1))^2\}$$

Radius of the cross section :  $\rho$

- $\rho : \mathbf{I} \rightarrow \mathbb{R}^{*+}, \mathcal{C}^\infty,$
- $0 < \rho_{\min} \leq \rho(x_1) \leq 1$
- $\mathbf{s}(x_1) = \pi(\rho(x_1))^2$

Weak Formulation :

$$\int_{[0, T] \times \Omega_\eta} \left( \frac{\partial m}{\partial t} - m \times \frac{\partial m}{\partial t} \right) \Psi = 2 \int_{[0, T] \times \Omega_\eta} \sum_{i=1}^3 m \times A \frac{\partial m}{\partial x_i} \cdot \frac{\partial \Psi}{\partial x_i} - 2 \int_{[0, T] \times \Omega_\eta} m \times H_d(m) \cdot \Psi.$$

- rescaling : fix domaine  $\Omega_1 = \{(x_1, \tilde{x}_2, \tilde{x}_3), x \in \mathbf{I}, (\tilde{x}_2)^2 + (\tilde{x}_3)^2 < (\rho(x_1))^2\}$
- $\eta \rightarrow 0$  in the weak formulation with  $\Psi(t, x_1, \tilde{x}_2, \tilde{x}_3) = \varphi(t, x_1)$



# 1d model of wire with non constant cross section

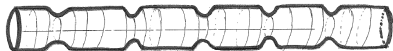

$$\Omega_\eta = \{(x_1, x_2, x_3), x_1 \in \mathbf{I}, (x_2)^2 + (x_3)^2 < \eta^2(\rho(x_1))^2\}$$

$$m : \mathbb{R}_t^+ \times \mathbf{I}_x \rightarrow \mathbb{S}^2,$$

$m$  is constant in the cross-section

$$\int_{[0, T] \times \mathbf{I}} \mathbf{s}(x) \left( \frac{\partial m}{\partial t} - m \times \frac{\partial m}{\partial t} \right) \varphi = 2 \int_{[0, T] \times \mathbf{I}} \mathbf{s}(x) m \times A \frac{\partial m}{\partial x} \cdot \frac{\partial \varphi}{\partial x} - 2 \int_{[0, T] \times \Omega_\eta} \mathbf{s}(x) m \times \frac{1}{2} (m_2 \mathbf{e}_2 + m_3 \mathbf{e}_3) \cdot \varphi.$$

$$\mathbf{s}(x) \frac{\partial m}{\partial t} = -m \times H_{\text{eff}} - m \times (m \times H_{\text{eff}})$$

$$H_{\text{eff}} = A \partial_x (\mathbf{s}(x) \partial_x m) - \frac{\mathbf{s}(x)}{2} (m_2 \vec{\mathbf{e}}_2 + m_3 \vec{\mathbf{e}}_3)$$

Radius of the cross section :  $\rho$

- $\rho : \mathbf{I} \rightarrow \mathbb{R}^{*+}, \mathcal{C}^\infty,$
- $0 < \rho_{\min} \leq \rho(x_1) \leq 1$
- $\mathbf{s}(x_1) = \pi(\rho(x_1))^2$

# 1d model of wire with non constant cross section

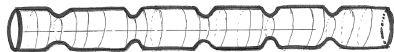

$$\Omega_\eta = \{(x_1, x_2, x_3), x_1 \in \mathbf{I}, (x_2)^2 + (x_3)^2 < \eta^2(\rho(x_1))^2\}$$

Radius of the cross section :  $\rho$

- $\rho : \mathbf{I} \rightarrow \mathbb{R}^{*+}, \mathcal{C}^\infty,$
- $0 < \rho_{\min} \leq \rho(x_1) \leq 1$
- $\mathbf{s}(x_1) = \pi(\rho(x_1))^2$

## Model of pinched wire

$$\frac{\partial m}{\partial t} = -m \times \mathcal{H}_{\text{eff}} - m \times (m \times \mathcal{H}_{\text{eff}})$$
$$\mathcal{H}_{\text{eff}} = A \partial_{xx} m + A \frac{\mathbf{s}'}{\mathbf{s}} \partial_x m - \frac{1}{2}(m_2 \vec{e}_2 + m_3 \vec{e}_3)$$

## 1d Ferromagnetism Energy

$$E(m) = \frac{A}{2} \int_{\mathbf{I}} \mathbf{s}(x) |\partial_x m|^2 dx + \frac{1}{4} \int_{\mathbf{I}} \mathbf{s}(x) (|m_2|^2 + |m_3|^2) dx$$

- 1 Physical Context
- 2 1d Model for ferromagnetic nanowires
- 3 Walls in constant-section wire**
- 4 Wall configurations for infinite nanowire with one notch
- 5 Wire with several notches
- 6 Applied Magnetic Field and Electric Current Effects

## Model of Nanowire

$$m : \mathbb{R}_t^+ \times I_x \rightarrow \mathcal{S}^2, I = \mathbb{R} \text{ or } I = [-L, L]$$

$$\frac{\partial m}{\partial t} = -m \times H_{\text{eff}} - m \times (m \times H_{\text{eff}})$$

$$H_{\text{eff}} = m_{xx} - (m_2 \vec{e}_2 + m_3 \vec{e}_3)$$

$$m_x(-L) = m_x(L) = 0$$

- $\varphi$  is constant
- $\theta'' + \cos \theta \sin \theta = 0$
- $\theta \rightarrow \pm\pi/2$  when  $x \rightarrow \pm\infty$  or  $\theta'(-L) = \theta'(L) = 0$

## Static Solutions : Walls

- $M(x) = R_{\varphi(x)} \begin{pmatrix} \sin \theta(x) \\ \cos \theta(x) \\ 0 \end{pmatrix}$

$$R_{\varphi} = \begin{pmatrix} 1 & 0 & 0 \\ 0 & \cos \varphi & -\sin \varphi \\ 0 & \sin \varphi & \cos \varphi \end{pmatrix}$$

- BC :  $\theta \rightarrow \pm\pi/2$  when  $x \rightarrow \pm\infty$   
 $\theta'(-L) = \theta'(L) = 0$

## Model of Nanowire

$$m : \mathbb{R}_t^+ \times I_x \rightarrow \mathcal{S}^2, I = \mathbb{R} \text{ or } I = [-L, L]$$

$$\frac{\partial m}{\partial t} = -m \times H_{\text{eff}} - m \times (m \times H_{\text{eff}})$$

$$H_{\text{eff}} = m_{xx} - (m_2 \vec{e}_2 + m_3 \vec{e}_3)$$

$$m_x(-L) = m_x(L) = 0$$

- $\varphi$  is constant
- $\theta'' + \cos \theta \sin \theta = 0$
- $\theta \rightarrow \pm\pi/2$  when  $x \rightarrow \pm\infty$  or  $\theta'(-L) = \theta'(L) = 0$

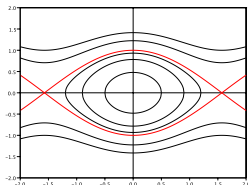

## Static Solutions : Walls

$$M(x) = R_{\varphi(x)} \begin{pmatrix} \sin \theta(x) \\ \cos \theta(x) \\ 0 \end{pmatrix}$$

$$R_{\varphi} = \begin{pmatrix} 1 & 0 & 0 \\ 0 & \cos \varphi & -\sin \varphi \\ 0 & \sin \varphi & \cos \varphi \end{pmatrix}$$

- BC :  $\theta \rightarrow \pm\pi/2$  when  $x \rightarrow \pm\infty$
- $\theta'(-L) = \theta'(L) = 0$

## Model of Nanowire

$$m : \mathbb{R}_t^+ \times \mathbb{R}_x \rightarrow \mathcal{S}^2,$$

$$\frac{\partial m}{\partial t} = m \times H_{\text{eff}} - m \times (m \times H_{\text{eff}})$$

$$H_{\text{eff}} = m_{xx} - (m_2 \vec{e}_2 + m_3 \vec{e}_3)$$

## Static Solution

$$M_0(x) = \begin{pmatrix} \tanh x \\ \frac{1}{\cosh x} \\ 0 \end{pmatrix}$$

G. Carbou, S. Labbé, *Stability for Static wall in a ferromagnetic Nanowire*, Discrete Contin. Dyn. Syst. Ser. B 6 (2006)

Stability of the constant profiles but not asymptotic stability

$$m(t, x) \rightarrow R_{\varphi_\infty} M_0(x - \sigma_\infty) \text{ when } t \rightarrow \infty$$

G. Carbou, S. Labbé, E. Trélat, *Control of travelling walls in a ferromagnetic nanowire*, Discrete Contin. Dyn. Syst. Ser. S 1 (2008), no. 1, 51–59

Controlability of the wall position by the mean of the applied field

## Model of Nanowire

$$m : \mathbb{R}_t^+ \times \mathbb{R}_x \rightarrow \mathcal{S}^2,$$

$$\frac{\partial m}{\partial t} = m \times H_{\text{eff}} - m \times (m \times H_{\text{eff}})$$

$$H_{\text{eff}} = m_{xx} - (m_2 \vec{e}_2 + m_3 \vec{e}_3)$$

## Static Solution

$$M_0(x) = \begin{pmatrix} \tanh x \\ \frac{1}{\cosh x} \\ 0 \end{pmatrix}$$

G. Carbou, S. Labbé, *Stability for Static wall in a ferromagnetic Nanowire*, Discrete Contin. Dyn. Syst. Ser. B 6 (2006)

Stability of the constant profiles but not asymptotic stability

$$m(t, x) \rightarrow R_{\varphi_\infty} M_0(x - \sigma_\infty) \text{ when } t \rightarrow \infty$$

G. Carbou, S. Labbé, E. Trélat, *Control of travelling walls in a ferromagnetic nanowire*, Discrete Contin. Dyn. Syst. Ser. S 1 (2008), no. 1, 51–59

Controlability of the wall position by the mean of the applied field

## Model of Nanowire

$$m : \mathbb{R}_t^+ \times [-L, L]_x \rightarrow \mathbb{S}^2$$

$$\frac{\partial m}{\partial t} = m \times H_{\text{eff}} - m \times (m \times H_{\text{eff}})$$

$$H_{\text{eff}} = m_{xx} - (m_2 \vec{e}_2 + m_3 \vec{e}_3)$$

$$m'(-L) = m'(L) = 0$$

## Static Solution

$$M_0(x) = \begin{pmatrix} \sin \theta(x) \\ \cos \theta(x) \\ 0 \end{pmatrix}, \quad \begin{aligned} \theta'' + \cos \theta \sin \theta &= 0, \\ \theta'(-L) = \theta'(L) &= 0 \end{aligned}$$

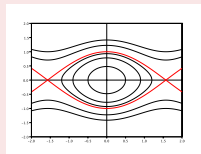

G. Carbou, S. Labbé, *Stabilization of walls for nano-wires of finite length*, ESAIM Control Optim. Calc. Var. 18 (2012)

- One wall in a finite wire : centered in the middle of the wire
- This solution is unstable



## Model of Nanowire

$$m : \mathbb{R}_t^+ \times [-L, L]_x \rightarrow \mathbb{S}^2$$

$$\frac{\partial m}{\partial t} = m \times H_{\text{eff}} - m \times (m \times H_{\text{eff}})$$

$$H_{\text{eff}} = m_{xx} - (m_2 \vec{e}_2 + m_3 \vec{e}_3)$$

$$m'(-L) = m'(L) = 0$$

## Static Solution

$$M_0(x) = \begin{pmatrix} \sin \theta(x) \\ \cos \theta(x) \\ 0 \end{pmatrix}, \quad \begin{aligned} \theta'' + \cos \theta \sin \theta &= 0, \\ \theta'(-L) = \theta'(L) &= 0 \end{aligned}$$

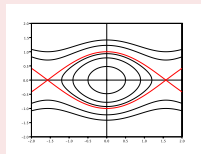

G. Carbou, S. Labbé, *Stabilization of walls for nano-wires of finite length*, ESAIM Control Optim. Calc. Var. 18 (2012)

- One wall in a finite wire : centered in the middle of the wire
- This solution is unstable

**The position of walls is unstable or non asymptotically stable**



The data storage is not reliable

Stabilization by Notches

**The position of walls is unstable or non asymptotically stable**



**The data storage is not reliable**

Stabilization by Notches

**The position of walls is unstable or non asymptotically stable**



**The data storage is not reliable**

**Stabilization by Notches**

- 1 Physical Context
- 2 1d Model for ferromagnetic nanowires
- 3 Walls in constant-section wire
- 4 Wall configurations for infinite nanowire with one notch**
- 5 Wire with several notches
- 6 Applied Magnetic Field and Electric Current Effects

# Model of infinite wire with one notch

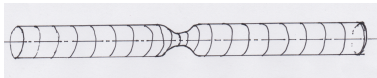

$$\Omega_\eta = \{(x, y, z), x \in \mathbb{R}, y^2 + z^2 < \eta^2(\rho(x))^2\}$$

## Radius of the section : $\rho$

- $\rho : \mathbb{R} \rightarrow \mathbb{R}^+, C^\infty$ ,
- $\rho = 1$  outside  $[-a, a]$ ,
- $\rho(-x) = \rho(x)$ ,
- $\rho$  non decreasing on  $[0, a]$
- $\mathbf{s}(x) = \pi(\rho(x))^2$

## Model of infinite wire with notch

$$m : \mathbb{R}_t^+ \times \mathbb{R}_x \rightarrow \mathcal{S}^2$$

$$\frac{\partial m}{\partial t} = -m \times \mathcal{H}_{\text{eff}} - m \times (m \times \mathcal{H}_{\text{eff}})$$

$$\mathcal{H}_{\text{eff}} = A \partial_{xx} m + A \frac{\mathbf{s}'}{\mathbf{s}} \partial_x m - \frac{1}{2} (m_2 \vec{e}_2 + m_3 \vec{e}_3)$$

$$E(m) = \frac{A}{2} \int_I \mathbf{s}(x) |\partial_x m|^2 dx + \frac{1}{4} \int_I \mathbf{s}(x) (|m_2|^2 + |m_3|^2) dx$$

## Model of infinite wire with notch

$$m : \mathbb{R}_t^+ \times \mathbb{R}_x \rightarrow \mathcal{S}^2,$$

$$\frac{\partial m}{\partial t} = -m \times \mathcal{H}_{\text{eff}} - m \times (m \times \mathcal{H}_{\text{eff}})$$

$$\mathcal{H}_{\text{eff}} = \partial_{xx} m + \frac{\mathbf{s}'}{\mathbf{s}} \partial_x m - (m_2 \vec{e}_2 + m_3 \vec{e}_3)$$

## Theorem (with D. Sanchez)

- Existence of a profile for one wall
- **Asymptotically stable for the position**

# Existence of profiles

- $M(x) = R_{\varphi(x)} \begin{pmatrix} \sin \bar{\theta}(x) \\ \cos \bar{\theta}(x) \\ 0 \end{pmatrix}$

$$R_{\varphi} = \begin{pmatrix} 1 & 0 & 0 \\ 0 & \cos \varphi & -\sin \varphi \\ 0 & \sin \varphi & \cos \varphi \end{pmatrix}$$

- $\bar{\theta} \rightarrow \pm\pi/2$  when  $x \rightarrow \pm\infty$

- $\varphi$  is constant

- $\bar{\theta}'' + \frac{\mathbf{s}'}{\mathbf{s}} \partial_x \bar{\theta} + \cos \bar{\theta} \sin \bar{\theta} = 0$

- $((\bar{\theta}')^2 - \cos^2 \bar{\theta})' = -2 \frac{\mathbf{s}'}{\mathbf{s}} (\bar{\theta}')^2$

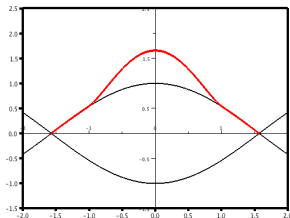
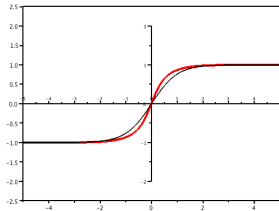

Shooting method to reach the separatrix after the notch



# Existence of profiles

- $M(x) = R_{\varphi(x)} \begin{pmatrix} \sin \bar{\theta}(x) \\ \cos \bar{\theta}(x) \\ 0 \end{pmatrix}$

$$R_{\varphi} = \begin{pmatrix} 1 & 0 & 0 \\ 0 & \cos \varphi & -\sin \varphi \\ 0 & \sin \varphi & \cos \varphi \end{pmatrix}$$

- $\bar{\theta} \rightarrow \pm\pi/2$  when  $x \rightarrow \pm\infty$

- $\varphi$  is constant

- $\bar{\theta}'' + \frac{\mathbf{s}'}{\mathbf{s}} \partial_x \bar{\theta} + \cos \bar{\theta} \sin \bar{\theta} = 0$

- $((\bar{\theta}')^2 - \cos^2 \bar{\theta})' = -2 \frac{\mathbf{s}'}{\mathbf{s}} (\bar{\theta}')^2$

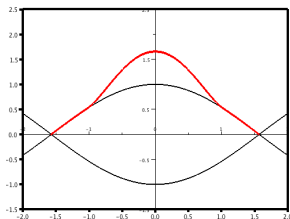
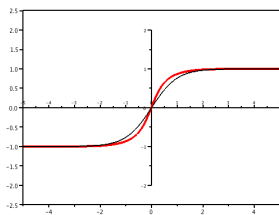

Shooting method to reach the separatrix after the notch

## Infinite Nanowire with one notch

$$m : \mathbb{R}_t^+ \times \mathbb{R}_x \rightarrow \mathbb{S}^2$$

$$\frac{\partial m}{\partial t} = -m \times H_{\text{eff}} - m \times (m \times H_{\text{eff}})$$

$$\mathcal{H}_{\text{eff}} = m_{xx} + \frac{\mathbf{s}'}{\mathbf{s}} m_x - m_2 \vec{e}_2 - m_3 \vec{e}_3$$

$$m \rightarrow \pm e_1 \text{ when } x \rightarrow \pm\infty$$

## Wall Profile

$$M_0(x) = \begin{pmatrix} \sin \bar{\theta}(x) \\ \cos \bar{\theta}(x) \\ 0 \end{pmatrix}$$

$$\bar{\theta}'' + \frac{\mathbf{s}'}{\mathbf{s}} \bar{\theta}' + \cos \bar{\theta} \sin \bar{\theta} = 0$$

$$\text{BC} : \bar{\theta} \rightarrow \pm\pi/2 \text{ when } x \rightarrow \pm\infty$$

**Stability of  $M_0$ , asymptotic stability for the position of the wall ?**

If  $\|m(t=0) - M_0\|_{H^1(\mathbb{R})}$  is small, then

- for all time,  $\|m(t) - M_0\|_{H^1(\mathbb{R})}$  remains small,
- $m(t)$  tends to  $R_{\theta_\infty}(M_0)$  when  $t$  tends to  $+\infty$ .

# Mobile frame

Geometrical constraint  $|m| = 1$

We describe the perturbations in the mobile frame

$$m(t, x) = \sqrt{1 - |r(t, x)|^2} M_0(x) + r_1(t, x) M_1(x) + r_2(t, x) M_2$$

$$M_0(x) = \begin{pmatrix} \sin \bar{\theta}(x) \\ \cos \bar{\theta}(x) \\ 0 \end{pmatrix} \quad M_1(x) = \begin{pmatrix} -\cos \bar{\theta}(x) \\ \sin \bar{\theta}(x) \\ 0 \end{pmatrix} \quad M_2 = \begin{pmatrix} 0 \\ 0 \\ 1 \end{pmatrix}$$

## New Equations for $r$

$$r : \mathbb{R}_t^+ \times \mathbb{R}_x \rightarrow \mathbb{R}^2$$

$$\partial_t r_1 = -L_1(r_1) - L_2(r_2) + \text{non linear}$$

$$\partial_t r_2 = L_1(r_1) - L_2(r_2) + \text{non linear}$$

$$L_1(r) = -\partial_{xx} r - \frac{s'}{s} \partial_x r + (\sin^2 \bar{\theta} - \cos^2 \bar{\theta}) r$$

$$L_2(r) = -\partial_{xx} r - \frac{s'}{s} \partial_x r + (\sin^2 \bar{\theta} - (\bar{\theta}')^2) r$$

## Exact Solution

$M_0$  for LL  $\sim 0$  for the new system

Stability of 0 ?

# Mobile frame

Geometrical constraint  $|m| = 1$

We describe the perturbations in the mobile frame

$$m(t, x) = \sqrt{1 - |r(t, x)|^2} M_0(x) + r_1(t, x) M_1(x) + r_2(t, x) M_2$$

$$M_0(x) = \begin{pmatrix} \sin \bar{\theta}(x) \\ \cos \bar{\theta}(x) \\ 0 \end{pmatrix} \quad M_1(x) = \begin{pmatrix} -\cos \bar{\theta}(x) \\ \sin \bar{\theta}(x) \\ 0 \end{pmatrix} \quad M_2 = \begin{pmatrix} 0 \\ 0 \\ 1 \end{pmatrix}$$

## New Equations for $r$

$$r : \mathbb{R}_t^+ \times \mathbb{R}_x \rightarrow \mathbb{R}^2$$

$$\partial_t r_1 = -L_1(r_1) - L_2(r_2) + \text{non linear}$$

$$\partial_t r_2 = L_1(r_1) - L_2(r_2) + \text{non linear}$$

$$L_1(r) = -\partial_{xx} r - \frac{s'}{s} \partial_x r + (\sin^2 \bar{\theta} - \cos^2 \bar{\theta}) r$$

$$L_2(r) = -\partial_{xx} r - \frac{s'}{s} \partial_x r + (\sin^2 \bar{\theta} - (\bar{\theta}')^2) r$$

## Exact Solution

$M_0$  for LL  $\sim 0$  for the new system

Stability of 0 ?

On  $L^2(\mathbb{R})$ , weighted scalar product :

$$\langle u | v \rangle = \int_{\mathbb{R}} \mathbf{s}(x) u(x) v(x) dx,$$

$$L_2 = -\frac{1}{\mathbf{s}} \partial_x (\mathbf{s} \partial_x) + (\sin^2 \bar{\theta} - (\bar{\theta}')^2) \implies L_2 \text{ is self-adjoint for } \langle \langle \rangle \rangle.$$

$$\langle L_2 u | v \rangle = \langle \ell u | \ell v \rangle, \quad \text{with } \ell = \partial_x + \bar{\theta}' \tan \bar{\theta}$$

$$L_2 \geq 0, \quad \text{Ker } L_2 = \mathbb{R}(\cos \bar{\theta})$$

- Valid whatever the configurations of the wire (several pinched zones)
- for one wall, on  $(\cos \bar{\theta})^\perp$ ,  $L_2 \geq \alpha_2 > 0$
- **Invariance by rotation**  $\implies 0$  is an eigenvalue of the linearized

$$L_1 = L_2 + (\bar{\theta}')^2 - \cos^2 \bar{\theta}$$

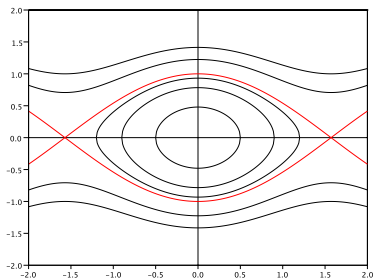

**Key point :  $L_1 \geq 0$  ?**

- Infinite nanowire without pinching :  $L_1 = L_2$ ,  $L_1 \geq 0$ . **Stability**
- Finite nanowire without pinching :  $L_1 = L_2 - c$ . **Bad sign, unstability for the position**

$$L_1 = L_2 + (\bar{\theta}')^2 - \cos^2 \bar{\theta}$$

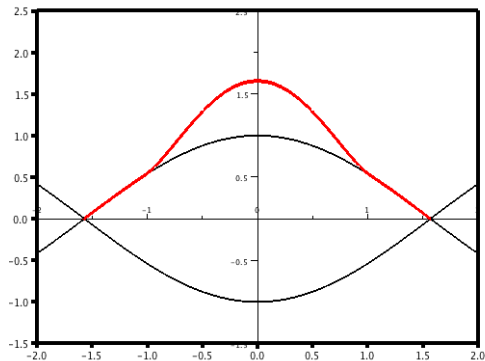

$$(\bar{\theta}')^2 - \cos^2 \bar{\theta} > 0 \text{ on Ker } L_2 \implies L_1 > 0$$

- 1 Physical Context
- 2 1d Model for ferromagnetic nanowires
- 3 Walls in constant-section wire
- 4 Wall configurations for infinite nanowire with one notch
- 5 Wire with several notches**
- 6 Applied Magnetic Field and Electric Current Effects



## Elementary cell of length $L$

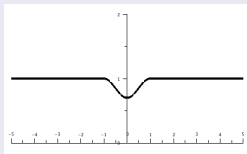

radius of the cross section :  $\bar{\rho}$

- $\bar{\rho} = 1$  outside  $[-a, a]$ ,
- $\bar{\rho}(-x) = \bar{\rho}(x)$ ,
- $\bar{\rho}$  non decreasing on  $[0, a]$
- $\bar{\mathbf{s}}(x) = \pi(\bar{\rho}(x))^2$

Wire with  $N - 1$  notches,  $L$  : distance between 2 consecutive notches

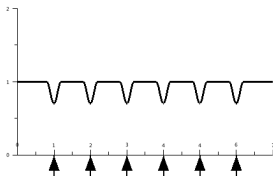

## Model of wire

$$\frac{\partial m}{\partial t} = -m \times \mathcal{H}_{eff} - m \times (m \times \mathcal{H}_{eff})$$

$$\mathcal{H}_{eff} = \partial_{xx} m + \frac{\mathbf{s}'}{\mathbf{s}} \partial_x m - (m_2 \vec{e}_2 + m_3 \vec{e}_3)$$

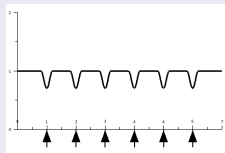

$$\mathbf{s}(x) = \begin{cases} \pi & \text{if } 0 \leq x \leq \frac{L}{2} \\ \bar{\mathbf{s}}(x - kL) & \text{if } kL - \frac{L}{2} \leq x \leq kL + \frac{L}{2} \\ \pi & \text{if } (N-1)L + \frac{L}{2} \leq x \leq NL \end{cases}$$

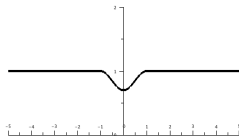

$$\mathbf{D} \in \{0, 1\}^N$$

Example 00111010

bit 0 : domain where  $m \sim -e_1$

bit 1 : domain where  $m \sim e_1$

Stationary solution in notched wire

$$\mathcal{F}_L(\theta) = -\partial_{xx}\theta - \frac{s'}{s}\partial_x\theta - \cos\theta \sin\theta$$

$$\mathcal{F}_L(\theta) = 0$$

$$\theta'(0) = \theta'(NL) = 0$$

$$M = \begin{pmatrix} \sin\theta \\ \cos\theta \\ 0 \end{pmatrix}$$

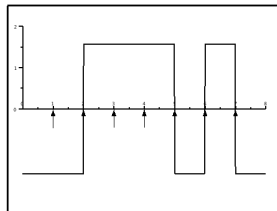

$$\mathbf{D} \in \{0, 1\}^N$$

Example 00111010

bit 0 : domain where  $m \sim -e_1$

bit 1 : domain where  $m \sim e_1$

### Stationary solution in notched wire

$$\mathcal{F}_L(\theta) = -\partial_{xx}\theta - \frac{\mathbf{s}'}{\mathbf{s}}\partial_x\theta - \cos\theta \sin\theta$$

$$\mathcal{F}_L(\theta) = 0$$

$$\theta'(0) = \theta'(NL) = 0$$

$$M = \begin{pmatrix} \sin\theta \\ \cos\theta \\ 0 \end{pmatrix}$$

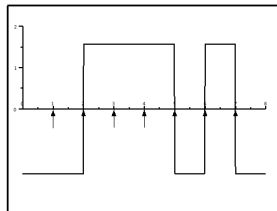

## Theorem (with D. Sanchez)

For all  $N$ , for  $L$  large enough, for all data in  $\{0, 1\}^N$ ,

- there exists a static solution encoding this data,
- this solution is asymptotically stable modulo rotation

Example 00111010

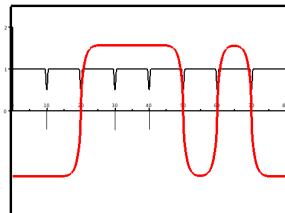
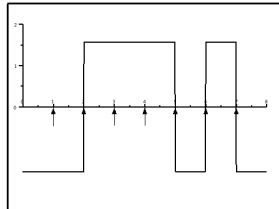

# Construction of an approximate solution $\Theta_a^L$

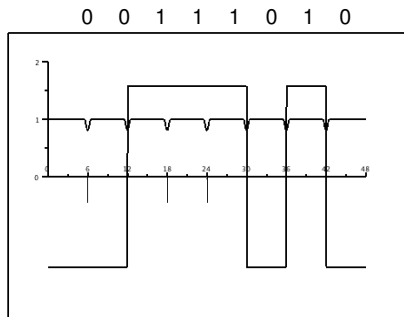

At the ends

$$\text{On } [0, L/2], \Theta_a^L = -\frac{\pi}{2}$$

$$\text{On } [NL - L/2, NL], \Theta_a^L = -\frac{\pi}{2}$$

Cells without  
magnetization switching

$$\text{On } [kL - L/2, kL + L/2],$$
$$\Theta_a^L = \pm \frac{\pi}{2}$$

# Construction of an approximate solution $\Theta_a^L$

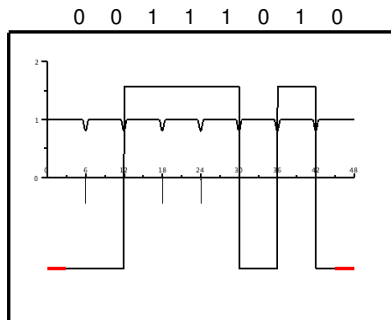

## At the ends

$$\text{On } [0, L/2], \Theta_a^L = -\frac{\pi}{2}$$

$$\text{On } [NL - L/2, NL], \Theta_a^L = -\frac{\pi}{2}$$

## Cells without magnetization switching

$$\text{On } [kL - L/2, kL + L/2],$$
$$\Theta_a^L = \pm \frac{\pi}{2}$$

# Construction of an approximate solution $\Theta_a^L$

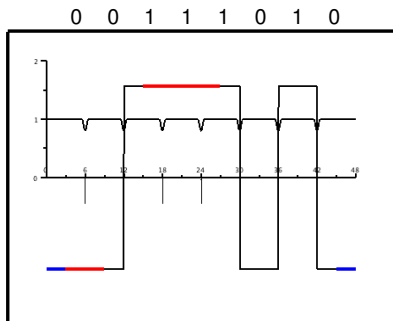

## At the ends

On  $[0, L/2]$ ,  $\Theta_a^L = -\frac{\pi}{2}$

On  $[NL - L/2, NL]$ ,  $\Theta_a^L = -\frac{\pi}{2}$

## Cells without magnetization switching

On  $[kL - L/2, kL + L/2]$ ,  
 $\Theta_a^L = \pm \frac{\pi}{2}$



# Construction of an approximate solution $\Theta_a^L$

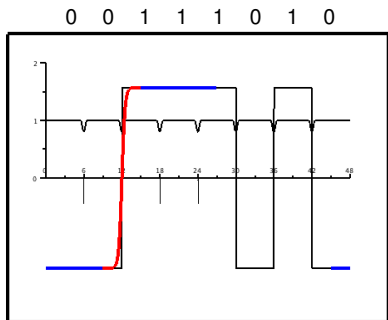

## Cells with DW

$$\Theta_a^L(x) = J_L(\pm(x - kL)),$$

- $J_L(x) = \bar{\theta}(x)$  for  $x \in [-L/3, L/3]$
- $J_L(x) = \pi/2$  for  $x \geq L/2$
- $J_L(x) \sim \pi/2$  for  $x \in [L/3, L/2]$

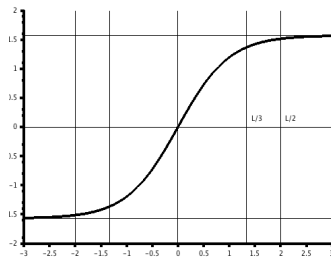

# Construction of an approximate solution $\Theta_a^L$

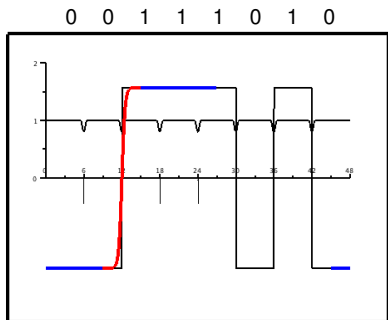

## Cells with DW

$$\Theta_a^L(x) = J_L(\pm(x - kL)),$$

- $J_L(x) = \bar{\theta}(x)$  for  $x \in [-L/3, L/3]$
- $J_L(x) = \pi/2$  for  $x \geq L/2$
- $J_L(x) \sim \pi/2$  for  $x \in [L/3, L/2]$

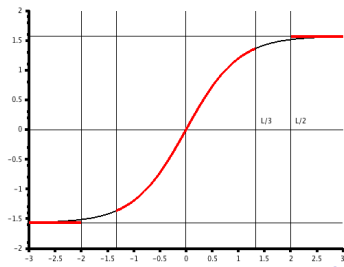

# Construction of an approximate solution $\Theta_a^L$

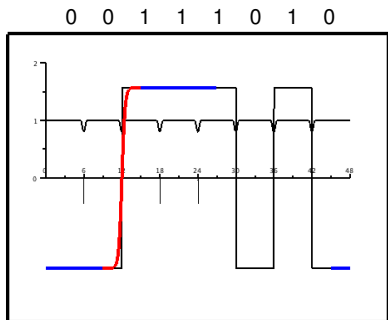

## Cells with DW

$$\Theta_a^L(x) = J_L(\pm(x - kL)),$$

- $J_L(x) = \bar{\theta}(x)$  for  $x \in [-L/3, L/3]$
- $J_L(x) = \pi/2$  for  $x \geq L/2$
- $J_L(x) \sim \pi/2$  for  $x \in [L/3, L/2]$

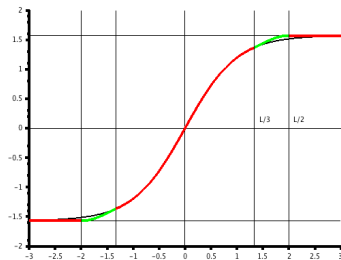

# Construction of an approximate solution $\Theta_a^L$

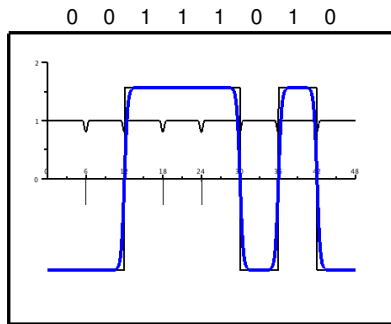

## Cells with DW

$$\Theta_a^L(x) = J_L(\pm(x - kL)),$$

- $J_L(x) = \bar{\theta}(x)$  for  $x \in [-L/3, L/3]$
- $J_L(x) = \pi/2$  for  $x \geq L/2$
- $J_L(x) \sim \pi/2$  for  $x \in [L/3, L/2]$

## Approximate Stationary

$$\mathcal{F}_L(\theta) = -\partial_{xx}\theta - \frac{\mathbf{s}'}{\mathbf{s}}\partial_x\theta - \cos\theta \sin\theta$$

$$\partial_x\Theta_a^L(0) = \partial_x\Theta_a^L(NL) = 0$$

$$\|\mathcal{F}(\Theta_a^L)\| \sim e^{-cL} \ll 1.$$

## Stationary solution for notched wire

$$\mathcal{F}(\theta) := -\partial_{xx}\theta - \frac{s'}{s}\partial_x\theta - \cos\theta\sin\theta$$

$$\left\{ \begin{array}{l} \mathcal{F}(\theta^L) = 0, \\ \partial_x\theta^L(0) = \partial_x\theta^L(NL) = 0, \\ \theta^L \text{ encodes the data.} \end{array} \right.$$

- $\theta^L = \Theta_a^L + v^L$
- $\mathcal{F}(\Theta_a^L)$  is small
- $\Lambda_a^L := \partial_\theta \mathcal{F}(\Theta_a^L)$

$$\Lambda_a^L(v) = -\partial_{xx}v - \frac{s'}{s}\partial_xv + (\sin^2\Theta_a^L - \cos^2\Theta_a^L)v$$

$$0 = \mathcal{F}(\Theta_a^L + v^L) = \mathcal{F}(\Theta_a^L) + \Lambda_a^L(v^L) + C(\Theta_a^L, v^L)(v^L, v^L), \quad \text{i.e. } v^L = \Phi_L(v^L)$$

$$\Phi_L(v) := -(\Lambda_a^L)^{-1} \left( \mathcal{F}(\Theta_a^L) + C(\Theta_a^L, v)(v, v) \right).$$

- $\Lambda_a^L$  is coercive on  $\mathbf{V} = \{v, v \in H^2, v'(0) = v'(NL) = 0\}$ ,
- $\|\Phi_L(v)\| \leq C(e^{-\alpha L} + \|v\|^2)$
- $\|\Phi_L(v) - \Phi_L(w)\| \leq K(\|v\| + \|w\|)\|v - w\|$

## Stationary solution for notched wire

$$\mathcal{F}(\theta) := -\partial_{xx}\theta - \frac{\mathbf{s}'}{\mathbf{s}}\partial_x\theta - \cos\theta\sin\theta$$

$$\left\{ \begin{array}{l} \mathcal{F}(\theta^L) = 0, \\ \partial_x\theta^L(0) = \partial_x\theta^L(NL) = 0, \\ \theta^L \text{ encodes the data.} \end{array} \right.$$

- $\theta^L = \Theta_a^L + v^L$
- $\mathcal{F}(\Theta_a^L)$  is small
- $\Lambda_a^L := \partial_\theta\mathcal{F}(\Theta_a^L)$

$$\Lambda_a^L(v) = -\partial_{xx}v - \frac{\mathbf{s}'}{\mathbf{s}}\partial_xv + (\sin^2\Theta_a^L - \cos^2\Theta_a^L)v$$

$$0 = \mathcal{F}(\Theta_a^L + v^L) = \mathcal{F}(\Theta_a^L) + \Lambda_a^L(v^L) + C(\Theta_a^L, v^L)(v^L, v^L), \quad \text{i.e. } v^L = \Phi_L(v^L)$$

$$\Phi_L(v) := -(\Lambda_a^L)^{-1} \left( \mathcal{F}(\Theta_a^L) + C(\Theta_a^L, v)(v, v) \right).$$

- $\Lambda_a^L$  is coercive on  $\mathbf{V} = \{v, v \in H^2, v'(0) = v'(NL) = 0\}$ ,
- $\|\Phi_L(v)\| \leq C(e^{-\alpha L} + \|v\|^2)$
- $\|\Phi_L(v) - \Phi_L(w)\| \leq K(\|v\| + \|w\|)\|v - w\|$

## Stationary solution for notched wire

$$\mathcal{F}(\theta) := -\partial_{xx}\theta - \frac{\mathbf{s}'}{\mathbf{s}}\partial_x\theta - \cos\theta\sin\theta$$

$$\left\{ \begin{array}{l} \mathcal{F}(\theta^L) = 0, \\ \partial_x\theta^L(0) = \partial_x\theta^L(NL) = 0, \\ \theta^L \text{ encodes the data.} \end{array} \right.$$

- $\theta^L = \Theta_a^L + v^L$
- $\mathcal{F}(\Theta_a^L)$  is small
- $\Lambda_a^L := \partial_\theta\mathcal{F}(\Theta_a^L)$

$$\Lambda_a^L(v) = -\partial_{xx}v - \frac{\mathbf{s}'}{\mathbf{s}}\partial_xv + (\sin^2\Theta_a^L - \cos^2\Theta_a^L)v$$

$$0 = \mathcal{F}(\Theta_a^L + v^L) = \mathcal{F}(\Theta_a^L) + \Lambda_a^L(v^L) + C(\Theta_a^L, v^L)(v^L, v^L), \quad \text{i.e. } v^L = \Phi_L(v^L)$$

$$\Phi_L(v) := -(\Lambda_a^L)^{-1} \left( \mathcal{F}(\Theta_a^L) + C(\Theta_a^L, v)(v, v) \right).$$

- $\Lambda_a^L$  is coercive on  $\mathbf{V} = \{v, v \in H^2, v'(0) = v'(NL) = 0\}$ ,
- $\|\Phi_L(v)\| \leq C(e^{-\alpha L} + \|v\|^2)$
- $\|\Phi_L(v) - \Phi_L(w)\| \leq K(\|v\| + \|w\|)\|v - w\|$

## Stationary solution for notched wire

$$\mathcal{F}(\theta) := -\partial_{xx}\theta - \frac{s'}{s}\partial_x\theta - \cos\theta\sin\theta$$

$$\left\{ \begin{array}{l} \mathcal{F}(\theta^L) = 0, \\ \partial_x\theta^L(0) = \partial_x\theta^L(NL) = 0, \\ \theta^L \text{ encodes the data.} \end{array} \right.$$

- $\theta^L = \Theta_a^L + v^L$
- $\mathcal{F}(\Theta_a^L)$  is small
- $\Lambda_a^L := \partial_\theta\mathcal{F}(\Theta_a^L)$

$$\Lambda_a^L(v) = -\partial_{xx}v - \frac{s'}{s}\partial_xv + (\sin^2\Theta_a^L - \cos^2\Theta_a^L)v$$

$$0 = \mathcal{F}(\Theta_a^L + v^L) = \mathcal{F}(\Theta_a^L) + \Lambda_a^L(v^L) + C(\Theta_a^L, v^L)(v^L, v^L), \quad \text{i.e. } v^L = \Phi_L(v^L)$$

$$\Phi_L(v) := -(\Lambda_a^L)^{-1} \left( \mathcal{F}(\Theta_a^L) + C(\Theta_a^L, v)(v, v) \right).$$

**Existence for  $v^L$  by fixed point method**

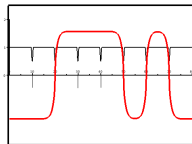



## Key point : coercivity of the linearization

$$\Lambda_a^L(v) = -\partial_{xx}v - \frac{\mathbf{s}'}{\mathbf{s}}\partial_x + f_a^L(x)v, \quad f_a^L(x) = \sin^2 \Theta_a^L - \cos^2 \Theta_a^L.$$

For  $L$  large enough,  $\Lambda_a^L$  is invertible

$$\exists c > 0, \exists L_0, \forall L \geq L_0, \forall v \in \mathbf{V}, \quad \langle \Lambda_a^L v | v \rangle \geq c \|v\|_{L_s^2}^2, \quad \text{where} \quad \langle u | v \rangle = \int_{\mathbb{R}} \mathbf{s}(x)u(x)v(x) dx$$

## Key point : coercivity of the linearization

$$\Lambda_a^L(v) = -\partial_{xx}v - \frac{\mathbf{s}'}{\mathbf{s}}\partial_x v + f_a^L(x)v, \quad f_a^L(x) = \sin^2 \Theta_a^L - \cos^2 \Theta_a^L.$$

For  $L$  large enough,  $\Lambda_a^L$  is invertible

$$\exists c > 0, \exists L_0, \forall L \geq L_0, \forall v \in \mathbf{V}, \quad \langle \Lambda_a^L v | v \rangle \geq c \|v\|_{L_s^2}^2, \quad \text{where} \quad \langle u | v \rangle = \int_{\mathbb{R}} \mathbf{s}(x)u(x)v(x) dx$$

- if  $\text{supp } v$  is in a domain :  $\Lambda_a^L(v) = -\partial_{xx}v - \frac{\mathbf{s}'}{\mathbf{s}}\partial_x v + v$

$$\langle \Lambda_a^L v | v \rangle = \|\partial_x v\|_{L_s^2}^2 + \|v\|_{L_s^2}^2$$

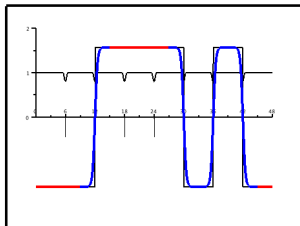

# Key point : coercivity of the linearization

$$\Lambda_a^L(v) = -\partial_{xx}v - \frac{s'}{s}\partial_x v + f_a^L(x)v, \quad f_a^L(x) = \sin^2 \Theta_a^L - \cos^2 \Theta_a^L.$$

For  $L$  large enough,  $\Lambda_a^L$  is invertible

$$\exists c > 0, \exists L_0, \forall L \geq L_0, \forall v \in \mathbf{V}, \quad \langle \Lambda_a^L v | v \rangle \geq c \|v\|_{L^2_s}^2, \quad \text{where} \quad \langle u | v \rangle = \int_{\mathbb{R}} \mathbf{s}(x)u(x)v(x) dx$$

- if  $\text{supp } v$  is around a DW,  $\Lambda_a^L(v) = -\partial_{xx}v - \frac{s'}{s}\partial_x v + (\sin^2 \bar{\theta} - \cos^2 \bar{\theta})v = L_1 v$

Infinite-wire case : OK

- Transitional zone :  $\Lambda_a^L(v) = -\partial_{xx}v - \frac{s'}{s}\partial_x v + f_a^L v$  et  $f_a^L \sim 1$

If  $L$  is large enough,  $\sim$  domain

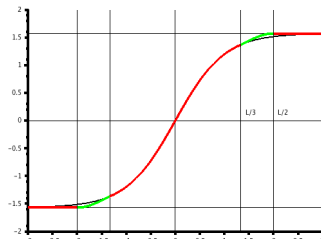
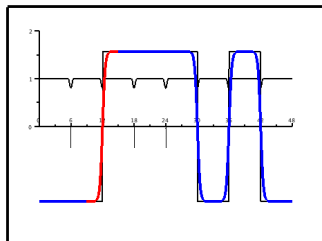

# Key point : coercivity of the linearization

$$\Lambda_a^L(v) = -\partial_{xx}v - \frac{\mathbf{s}'}{\mathbf{s}}\partial_x v + f_a^L(x)v, \quad f_a^L(x) = \sin^2 \Theta_a^L - \cos^2 \Theta_a^L.$$

For  $L$  large enough,  $\Lambda_a^L$  is invertible

$$\exists c > 0, \exists L_0, \forall L \geq L_0, \forall v \in \mathbf{V}, \quad \langle \Lambda_a^L v | v \rangle \geq c \|v\|_{L^2_{\mathbf{s}}}^2, \quad \text{where} \quad \langle u | v \rangle = \int_{\mathbb{R}} \mathbf{s}(x)u(x)v(x) dx$$

- if  $\text{supp } v$  is around a DW,  $\Lambda_a^L(v) = -\partial_{xx}v - \frac{\mathbf{s}'}{\mathbf{s}}\partial_x v + (\sin^2 \bar{\theta} - \cos^2 \bar{\theta})v = L_1 v$

Infinite-wire case : OK

- Transitional zone :  $\Lambda_a^L(v) = -\partial_{xx}v - \frac{\mathbf{s}'}{\mathbf{s}}\partial_x v + f_a^L v$  et  $f_a^L \sim 1$

If  $L$  is large enough,  $\sim$  domain

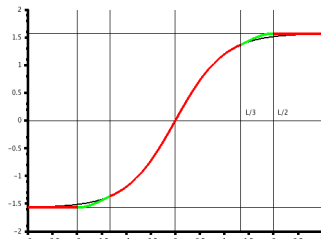
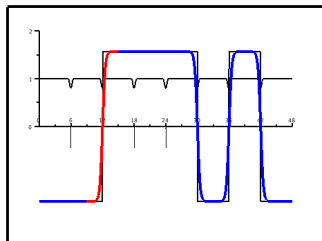

# Key point : coercivity of the linearization

$$\Lambda_a^L(v) = -\partial_{xx}v - \frac{\mathbf{s}'}{\mathbf{s}}\partial_xv + f_a^L(x)v, \quad f_a^L(x) = \sin^2 \Theta_a^L - \cos^2 \Theta_a^L.$$

## IMS Formula

- $\chi_i \in C^\infty$
- around the  $j^{\text{th}}$  wall centered in  $x_j$  :

$$\chi_j(x) = \psi\left(\frac{x - x_j}{L}\right)$$

- $\text{supp } \chi_0$  in the quasi-domains

- 

$$\sum_{i=0}^k (\chi_i)^2 = 1$$

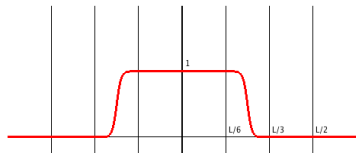

$$\langle \Lambda_a^L(v) | v \rangle = \sum_{j=0}^k \langle \Lambda_a^L(\chi_j v) | \chi_j v \rangle + \mathcal{O}\left(\frac{1}{L}\right) \|v\|_{L^2_S}^2$$

for  $L$  large enough,  $\Lambda_a^L$  is coercive

# Key point : coercivity of the linearization

$$\Lambda_a^L(v) = -\partial_{xx}v - \frac{s'}{s}\partial_xv + f_a^L(x)v, \quad f_a^L(x) = \sin^2 \Theta_a^L - \cos^2 \Theta_a^L.$$

## IMS Formula

- $\chi_i \in C^\infty$
- around the  $j^{\text{th}}$  wall centered in  $x_j$  :

$$\chi_j(x) = \psi\left(\frac{x - x_j}{L}\right)$$

- $\text{supp } \chi_0$  in the quasi-domains

- 

$$\sum_{i=0}^k (\chi_i)^2 = 1$$

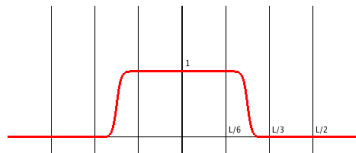

$$\langle \Lambda_a^L(v) | v \rangle = \sum_{j=0}^k \langle \Lambda_a^L(\chi_j v) | \chi_j v \rangle + \mathcal{O}\left(\frac{1}{L}\right) \|v\|_{L_s^2}^2$$

for  $L$  large enough,  $\Lambda_a^L$  is coercive

# Key point : coercivity of the linearization

$$\Lambda_a^L(v) = -\partial_{xx}v - \frac{s'}{s}\partial_xv + f_a^L(x)v, \quad f_a^L(x) = \sin^2 \Theta_a^L - \cos^2 \Theta_a^L.$$

## IMS Formula

- $\chi_i \in C^\infty$
- around the  $j^{\text{th}}$  wall centered in  $x_j$  :

$$\chi_j(x) = \psi\left(\frac{x - x_j}{L}\right)$$

- $\text{supp } \chi_0$  in the quasi-domains

- 

$$\sum_{i=0}^k (\chi_i)^2 = 1$$

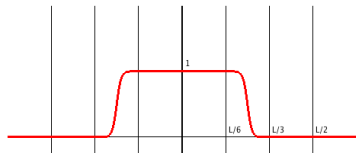

$$\langle \Lambda_a^L(v) | v \rangle = \sum_{j=0}^k \langle \Lambda_a^L(\chi_j v) | \chi_j v \rangle + \mathcal{O}\left(\frac{1}{L}\right) \|v\|_{L_s^2}^2$$

for  $L$  large enough,  $\Lambda_a^L$  is coercive

There exists a solution close to  $\Theta_a^L$

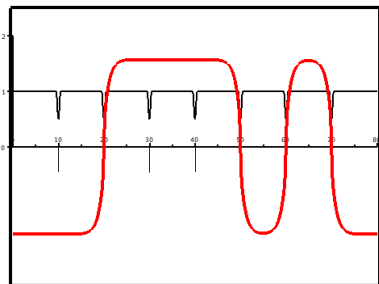
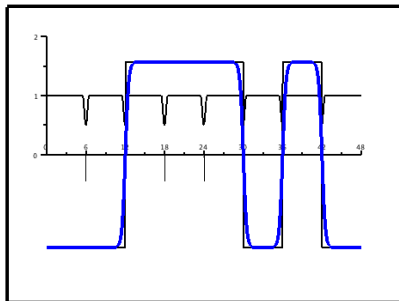

This solution is asymptotically stable modulo rotation around the wire axis

DW are pinned by the notches



- 1 Physical Context
- 2 1d Model for ferromagnetic nanowires
- 3 Walls in constant-section wire
- 4 Wall configurations for infinite nanowire with one notch
- 5 Wire with several notches
- 6 Applied Magnetic Field and Electric Current Effects**

## Notched Nanowire

$$m : \mathbb{R}_t^+ \times I_x \rightarrow \mathcal{S}^2$$

$$\frac{\partial m}{\partial t} = -m \times H_{\text{eff}} - m \times (m \times H_{\text{eff}})$$

$$\mathcal{H}_{\text{eff}} = m_{xx} + \frac{\mathbf{s}'}{\mathbf{s}} m_x - m_2 \vec{e}_2 - m_3 \vec{e}_3 + h_a \vec{e}_1$$

### Boundary Conditions

Constant-cross-section wire : precessional regime

$$m(t, x) = R_{h_a t} M_0(x + h_a t)$$

### Notched wire :

For small  $h_a$  : the wall does not move, remains in the notch (static solution), its profile is planar.

Construction of the solution by implicit function theorem

## Notched Nanowire

$$m : \mathbb{R}_t^+ \times I_x \rightarrow \mathcal{S}^2$$

$$\frac{\partial m}{\partial t} = -m \times H_{\text{eff}} - m \times (m \times H_{\text{eff}})$$

$$\mathcal{H}_{\text{eff}} = m_{xx} + \frac{\mathbf{s}'}{\mathbf{s}} m_x - m_2 \vec{e}_2 - m_3 \vec{e}_3 + h_a \vec{e}_1$$

Boundary Conditions

Constant-cross-section wire : precessional regime

$$m(t, x) = R_{h_a t} M_0(x + h_a t)$$

Notched wire :

For small  $h_a$  : the wall does not move, remains in the notch (static solution), its profile is planar.

Construction of the solution by implicit function theorem

## Notched Nanowire

$$m : \mathbb{R}_t^+ \times I_x \rightarrow S^2$$

$$\frac{\partial m}{\partial t} = -m \times H_{\text{eff}} - m \times (m \times H_{\text{eff}})$$

$$\mathcal{H}_{\text{eff}} = m_{xx} + \frac{\mathbf{s}'}{\mathbf{s}} m_x - m_2 \vec{e}_2 - m_3 \vec{e}_3 + h_a \vec{e}_1$$

Boundary Conditions

Constant-cross-section wire : precessional regime

$$m(t, x) = R_{h_a t} M_0(x + h_a t)$$

**Notched wire :**

For small  $h_a$  : the wall does not move, remains in the notch (static solution), its profile is planar.

Construction of the solution by implicit function theorem

## Infinite Notched Nanowire

$$m : \mathbb{R}_t^+ \times \mathbb{R}_x \rightarrow \mathcal{S}^2$$

$$\frac{\partial m}{\partial t} = -m \times H_{\text{eff}} - m \times (m \times H_{\text{eff}})$$

$$\mathcal{H}_{\text{eff}} = m_{xx} + \frac{\mathbf{s}'}{\mathbf{s}} m_x - m_2 \vec{e}_2 - m_3 \vec{e}_3 + h_a \vec{e}_1$$

For  $h_a \geq \frac{\pi - \mathbf{s}(0)}{\pi + \mathbf{s}(0)}$ , there is no static solution with one DW

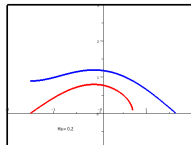
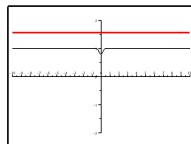
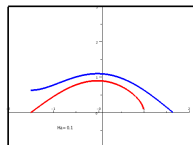
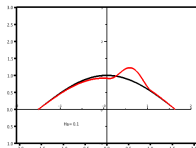
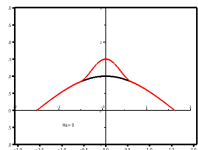

## Notched Nanowire

$$m : \mathbb{R}_t^+ \times I_x \rightarrow S^2$$

$$\frac{\partial m}{\partial t} = -m \times H_{\text{eff}} - m \times (m \times H_{\text{eff}}) - \frac{\mathbf{v}}{\mathbf{s}} \partial_x m - \frac{\mathbf{v}}{\mathbf{s}} m \times \partial_x m$$

$$\mathcal{H}_{\text{eff}} = m_{xx} + \frac{\mathbf{s}'}{\mathbf{s}} m_x - m_2 \vec{e}_2 - m_3 \vec{e}_3$$

Boundary Conditions

### Notched wire :

- the wall remains in the notch
- non planar configuration
- the profile turns around the wire
- Depinning by electric current ???

## Notched Nanowire

$$m : \mathbb{R}_t^+ \times I_x \rightarrow S^2$$

$$\frac{\partial m}{\partial t} = -m \times H_{\text{eff}} - m \times (m \times H_{\text{eff}}) - \frac{\mathbf{v}}{\mathbf{s}} \partial_x m - \frac{\mathbf{v}}{\mathbf{s}} m \times \partial_x m$$

$$\mathcal{H}_{\text{eff}} = m_{xx} + \frac{\mathbf{s}'}{\mathbf{s}} m_x - m_2 \vec{e}_2 - m_3 \vec{e}_3$$

Boundary Conditions

### Notched wire :

- the wall remains in the notch
- non planar configuration
- the profile turns around the wire
- Depinning by electric current ???

We proved the reliability of this kind of storage devices if  $L$  is large enough

- Stability threshold for  $L$  ?
- Dynamics of the walls in notched wires ?
- Recording (Creation of walls) ?

Thank you for your attention



We proved the reliability of this kind of storage devices if  $L$  is large enough

- Stability threshold for  $L$  ?
- Dynamics of the walls in notched wires ?
- Recording (Creation of walls) ?

Thank you for your attention

We proved the reliability of this kind of storage devices if  $L$  is large enough

- Stability threshold for  $L$  ?
- Dynamics of the walls in notched wires ?
- Recording (Creation of walls) ?

**Thank you for your attention**