



HAL
open science

A Comprehensive Load Process at the DLR – Definition, Analysis, and Experimental Evaluation

W.R. Krüger, P.D. Ciampa, M. Geier, T. Kier, T. Klimmek, D. Kohlgrüber,
P. Ohme, K. Risse, J. Schwinn

► **To cite this version:**

W.R. Krüger, P.D. Ciampa, M. Geier, T. Kier, T. Klimmek, et al.. A Comprehensive Load Process at the DLR – Definition, Analysis, and Experimental Evaluation. *Aerospace Lab*, 2018, 14, pp.1-16. 10.12762/2018.AL14-01 . hal-01935123

HAL Id: hal-01935123

<https://hal.science/hal-01935123v1>

Submitted on 26 Nov 2018

HAL is a multi-disciplinary open access archive for the deposit and dissemination of scientific research documents, whether they are published or not. The documents may come from teaching and research institutions in France or abroad, or from public or private research centers.

L'archive ouverte pluridisciplinaire **HAL**, est destinée au dépôt et à la diffusion de documents scientifiques de niveau recherche, publiés ou non, émanant des établissements d'enseignement et de recherche français ou étrangers, des laboratoires publics ou privés.

W. R. Krüger, P. D. Ciampa,
M. Geier, T. Kier, T. Klimmek,
D. Kohlgrüber, P. Ohme, K. Risse,
J. Schwinn

German Aerospace Center (DLR)

E-mail: wolf.krueger@dlr.de

DOI: 10.12762/2018.AL14-01

A Comprehensive Load Process at the DLR – Definition, Analysis, and Experimental Evaluation

The determination of loads acting on the aircraft is one of the main tasks during aircraft development. The knowledge of loads is important for aircraft design, e.g., for the sizing of the airframe structure, as well as for certification. The definition of realistic load assumptions is important, as well as the generation of loads from simulation and experiment. The DLR is involved in a large number of aircraft design activities, and operates a fleet of research aircraft; thus, the DLR requires in-depth expertise for the definition and the determination of relevant and crucial load cases.

The aim of the iLOADS project is the development of an internal DLR load process, comprising expertise from various DLR institutes. The goal of the process is to strengthen the assessment capabilities of the DLR with respect to the influence of loads on new aircraft configurations, and to support certification capabilities for the DLR aircraft fleet. The load process is investigated with regard to the influence of various analysis approaches on aircraft structural design, and it is subject to verification and validation on different aircraft configurations.

The paper will give an overview of the background of the iLOADS project, as well as of the work performed in the project. The definition of the load process, as well as the implementations for different applications investigated in the project, will be presented in more detail.

iLOADS: a Comprehensive Load Process for DLR Needs

Background

To determine the loads acting upon the aircraft is one of the main tasks during aircraft design. Wright and Cooper, [1], summarize the task as follows: "Aircraft are subject to a range of static and dynamic loads resulting from flight maneuvers, ground maneuvers and gust/turbulence encounters. These load cases are responsible for the critical design loads over the aircraft structure and thus influence the structural design." Knowledge of the loads is thus required for design and structural sizing, and for prediction of the performance, as well as for certification. The definition of realistic load cases and the determination of loads during simulation and experiment are important.

The DLR carries out a great number of activities in aircraft preliminary design and in the operation of a fleet of research aircraft, and thus

requires in-depth expertise for the analysis of relevant and crucial load cases. Thus, the DLR needs an established comprehensive and well-founded load process. At the same time, the various DLR institutes have extensive knowledge regarding numerous aspects of the field of load analysis. This expertise covers pragmatic approaches to high-end methods for both simulation and testing.

The DLR project iLOADS, "integrated LOADS at the DLR", answers to those requirements. The expertise in load analysis is combined and integrated into a comprehensive load process. Such a process has been formally defined in the project, and global rules for analysis and documentation have been set. Selected numerical methods for load analysis have been evaluated, and the load process has been used

to investigate the influence of various analysis approaches to aircraft structural design. Finally, the process has been subjected to verification and validation on different aircraft configurations, both numerically and experimentally.

Project Goals and Technical Content

Two main goals of the iLOADS projects were defined:

- the definition, implementation and validation of a load process tailored to DLR needs, and
- the support of the certification activities of the DLR aircraft fleet.

The project was structured into four work packages. In the first work package, the load process was defined and documented with respect to the DLR requirements. In the second work package, numerical simulation methods of varying complexity were compared, with a focus on aerodynamic methods, as well as on methods for the analysis of discrete gusts and for man oeuvre loads. In the third work package, various approaches for the sizing of fuselage structures have been compared and validated with experimental data. In the fourth work package, implementations of the load process have been applied to different use cases – these applications were the generation of preliminary design loads for a transport aircraft configuration, the numerical analysis of loads for an existing long-range aircraft, and the measurement of loads during flight testing on two aircraft, first on the structure of a sailplane, and second on the outer store of a high-altitude research aircraft. The current article follows the outline given in [2]. The work of Work Packages 2, 3 and 4 is summarized further down in the paper and described in detail in separate papers, see [3], [4], [5], [6], [7] and [8].

Related Activities

Load analysis plays a role in a number of running activities, both for the application of load analysis and for the development of selected load analysis methods.

At the DLR, a load process for conceptual design has been established and used in the VAMP and FrEACs projects [9]. The validation and application of approaches for gust load analysis have been part of the iGREEN [10] and ALLEGRA projects, including both numerical investigations and wind tunnel experiments on a transonic gust generator in the transonic wind tunnel Göttingen, TWG-DNW [11]. The DLR-project Digital-X has focused on the application of CFD and complex structural models in aircraft design loops, as well as on implementing an iterative process for loads and sizing [12]. Several projects of the German National Aeronautics Research Program (Lufo), e.g., the Lufo 4 projects M-FLY and FTEG, covered improvement and validation of load analysis methods in an industrial context. Within the framework of EU projects, the FP7 project Smart Fixed Wing Aircraft (SFWA) included a work package dedicated to load analysis on passive and active wings, including load alleviation strategies [13]. Reduced order methods and CFD-based gust analysis is the topic of the FP8-H2020 project AEROGUST [14].

Most of the projects mentioned concentrate on specific details of the load analysis, on the application of design aspects, or on the automation of a load process for MDO purposes. The DLR project iLOADS focuses in addition on the completeness and the quality of the load process as such.

Load Process

Definitions

The term "loads" is used in a wide context and with a variety of meanings, thus requiring the definition of the term as it will be used within the context of the paper.

"Loads" will be used to describe forces and moments acting on the aircraft structure, resulting from air pressure (lift, pressurization), mass forces (inertia, gravity), structural forces (elasticity) and other forces, such as landing impact or thrust.

The term "load process" will be used as follows:

- for given boundary conditions (e.g., operating conditions, or certification requirements),
- for a given configuration (aircraft or component),
- loads on the structure shall be determined,
- with methods of adequate fidelity,
- the loads will be used for structural design, configuration assessment, or aircraft certification.

Frequently, the term load is also used in the sense of cargo or additional equipment. While freight, of course, also inflicts mass forces on the aircraft, we will try not to mix these connotations. Furthermore, the paper will concentrate on mechanical (structural) loads, electric loads will not be addressed; they are an important topic when designing an aircraft, but with little direct impact on the structural load process.

"Classes" of loads are often combined in categories. A common classification differentiates between flight loads (man oeuvre loads, gust loads), ground loads (landing loads, ground maneuvers), inertial loads (oscillations, vibrations), and special load cases (pressurization, bird strike, crash/ditching, fatigue).

A complete load loop will consist of a large number of single analyses, potentially thousands. This, consequently, requires a well-structured data management and a careful and thorough evaluation, condensation and interpretation of the results, in order to be able to perform reliable assessments.

Standard Literature

A number of publications cover the load process and load analysis methods. The books by Lomax [15], concerning structural load analysis, and by Hoblit [16], covering gust analysis, are considered standard literature, as well as the book by Howe [17]. The textbook by Wright and Cooper [1] concerns the representation of the underlying physical effects. Important boundary conditions arise from certification and the respective specifications [18], [19]. The standard tasks of a load process are well described in the often-cited article by Neubauer and Günther [20].

Requirements

Approaches for industrial load analysis are dependent on aircraft size and type, regulations (CS-22 / CS-23 / CS-25), company size and company design philosophy. The DLR load process is defined to address specific DLR requirements. Criteria for the process are derived from the application scenarios. All tasks have in common that

a great number of analyses must be performed in a limited amount of time. Thus, the process has to be comprehensive for a given task, and performed with adequate fidelity. The process must be subjected to quality management under the following key topics – it must be possible to understand the approach, to reproduce all results, and to document and review the process and results. The process has to be maintained; availability of methods as well as of operators educated in the process is important.

The core process defined in the project consists of the following phases, see Figure 1:

- **Load case definition phase**
i.e., the definition of relevant load cases for analysis, and of requirements for the models to be used.
- **Load analysis phase**
i.e., the analysis of maneuver loads, gust loads, landing loads, special load cases, etc.
- **Load post-processing phase**
The creation of a load database that can be processed according to the quantities needed; e.g., cut loads (cross-section loads) for evaluation or maximum nodal loads for sizing.

Specifications for the necessary analyses result from the operational requirements, like the projected flight speeds and altitudes of the aircraft. A catalogue of load cases is defined depending on those boundary conditions. Load cases defined in this catalogue will then be addressed subsequently.

The calculation of loads is a wide field, and the use of many different simulation tools depending on the load cases (maneuvers, gusts, landing, bird strike, etc.) might be necessary. Agreement on a common nomenclature and on common interfaces for model data and result data is therefore essential, and was part of the project.

The results of the analyses will be collected and used for the design and evaluation of configurations; for example, for structural sizing and aircraft mass estimation. For quick representation and comparability of project results, section loads defined on load reference axes were used. For wing structure sizing purposes, nodal loads were also available.

The load transfer from analysis to sizing and structural optimization includes two steps. First, load analyses are performed, where the number of load cases depends on the task. For the generation of a representative aircraft mass in the early design stages, less than 20 cases have shown to be sufficient. For the sizing of the wing and empennage, control points on the wings are defined, the so called "stations", at which section loads are monitored. For each station, load envelopes are created, see Figure 1, right. In the DLR process, structural sizing is usually performed as a structural optimization task, for which all load cases lying on the border of any envelope are provided to the structural optimization solution; see also [10] and [12]. Experience shows that with the current automated approach, about 100 flight load cases are activated for the sizing of a wing structure.

It should be noted that the selection of load cases considered in the project has been driven by the DLR requirements, in the sense of applications, as described in Section "Project Goals and Technical Content" above. First, the DLR interest is mainly on the numerical investigation of global loads to assess aircraft configurations in design studies with various levels of complexity. Second, there is the necessity to support experimental activities on test rigs or on research aircraft, where modifications of the aircraft are often at the component level, e.g., very often the installation of large antennas or sensor equipment. Thus, not all load analyses that are obligatory for the development and certification of a new aircraft on an industrial scale have been included in the DLR load loop in the course of the iLOADS project. Temperature loads have not been taken into consideration. Also, loads resulting from internal systems and equipment are not part of the standard approach and are only calculated as stand-alone investigations when specifically requested, for example, for the certification of a flight test modification.

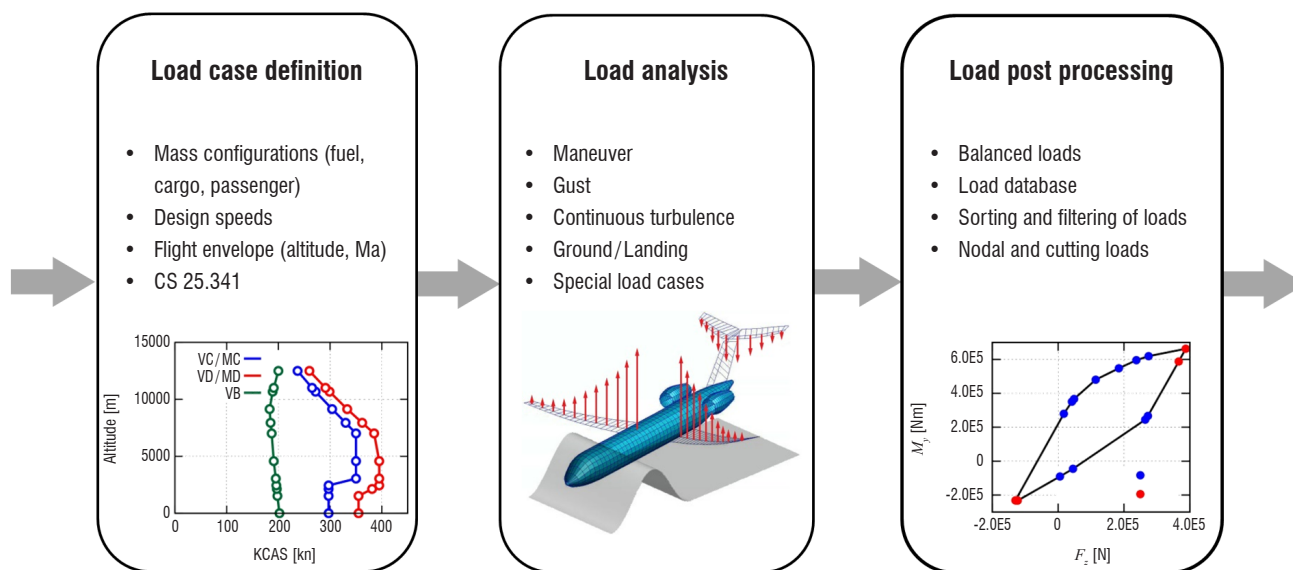

Figure 1 – Phases of the DLR load process

Aircraft Configurations

At the beginning of the project it was agreed to perform as many analyses as possible on a common reference configuration. For this purpose, the so-called DLR D150 configuration was available; that is, an aircraft design similar to an A320 in size, see Figures 2 and 4 below. For the D150, data was available from previous DLR projects [21]. A structural design, as well as aerodynamic data, both in the form of a Doublet Lattice Model (DLM) and CFD data, could be used. The wing geometry used for CFD meshes corresponds to the DLR F-6 configuration [22]. The experimental structural investigations (see Section "Loads and Structural Design") were also based on the geometry and loads calculated for the D150 aircraft.

Furthermore, design load data from two production aircraft could be used for comparison in the iLOADS project, the first data being taken from the VFW 614 design documentation, and the second data being provided by Gulfstream Aerospace in the course of the certification of the HALO atmospheric research aircraft, operated by the DLR [23].

Tools and Data Format

A number of different analysis tools have been used in the iLOADS project, depending on the application. Where necessary, details will be provided in the respective sections below. Commercial software packages used were the finite element codes ANSYS [24] and MSC.NASTRAN [25]. For CFD analysis, the DLR TAU code was used [26]. Load analysis was performed using MSC.NASTRAN and the DLR/Airbus development VARLOADS [27]. The DLR tool MONA (ModGen & NASTRAN) [10] was used for parametric modelling (ModGen) and sizing using the structural optimization routines of NASTRAN. For ANSYS, finite element models were set up by the DLR tools DELiS [28] and TRAFUMO [29], while sizing was performed using the commercial tool HyperSizer [30] or the DLR development S-BOT [28]. As much as possible, model definition and data exchange was performed in the CPACS format [33].

Analysis of Dynamic Loads

In this work package, simulation methods for load analysis were investigated. Focus was on the evaluation of different modelling levels-of-detail for aerodynamic analysis, and also for the analysis of maneuver loads, gust loads and landing loads. For those load classes, a comparison of load levels coming from dynamic analyses with loads derived from equivalent static load cases has been performed. Section "Analysis of Dynamic Loads" gives a summary of the activities in the work package. A comprehensive overview can be found in [3].

Aerodynamic Loads

Aerodynamic analyses in this work package were performed by the Institute of Aerodynamics and Flow Technology. Work was initially planned to be executed on the D150 configuration. It quickly showed that the wing geometry resulting from the preliminary design phase of that aircraft, and stored in the CPACS data, was not suitable for CFD analysis, since standard subsonic profiles have been used in that phase. It was thus agreed to use the geometry of the DLR F-6 configuration, which is very similar to that of the pre-design wing but with a transonic profile, as the reference for aerodynamic investigations, see Figure 2.

The following aerodynamic tools were taken into consideration for the comparison of methods:

- LIFTING_LINE (a multi lifting-line approach, DLR) [34]
- VSAERO (3D-Panel Method, commercial) [35]
- TAU (3D-Navier-Stokes-Solver, DLR) [26]

It should be noted that the LIFTING_LINE and VSAERO-interfaces are currently restricted to configurations with wing and empennage only, consequently neglecting the fuselage. This fact was acknowledged in the discussion of the results.

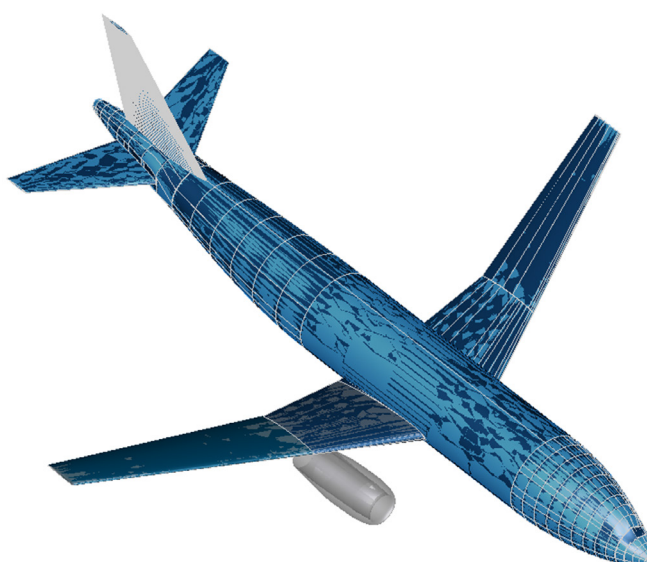

Figure 2 – Comparison of geometrical representations of the DLR-F6-D150 configuration using CATIA and CPACS

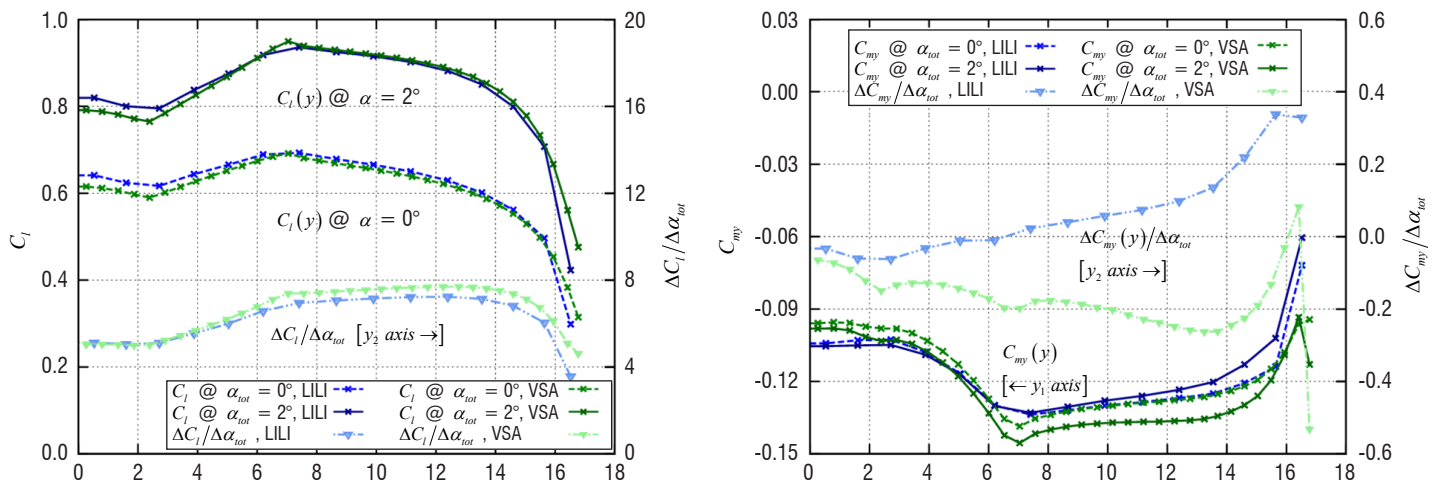

Figure 3 – Comparison of C_l and C_m distributions between LIFTING_LINE (LILI) and VSAERO (VSA)

An important step was the definition of assessment criteria for the calculation of aerodynamic parameters for load analysis. The following quantities were selected as relevant:

- global aerodynamic coefficients, especially the lift coefficient C_l and moment coefficient C_{My} ,
- distribution of local aerodynamic coefficients, especially of C_l and C_{My} ,
- gradients of aerodynamic coefficients with respect to angle of attack, especially $\Delta C_l / \Delta \alpha_{tot}$ and $\Delta C_{My} / \Delta \alpha$.

As an example, Figure 3 shows the span-wise distribution of the lift C_l and moment C_m , as well as the local gradients with respect to the total angle of attack α_{tot} at the transonic Mach number of $M = 0.75$. The small absolute deviations also confirm the agreement of the (subsonic) compressibility corrections implemented in both tools. The good agreement for the C_l gradients could also be shown for wing-tail configurations. While the span-wise distribution of C_{My} in Figure 3, right, shows deviations in the absolute values, but still with similar trends, very significant deviations are observed for the gradients with respect to α_{tot} , which is due to different sensitivities of the center of pressure between the multiple lifting-line method and the panel method.

This must be carefully checked during tool selection, when being applied for load analysis and prediction, as well as in the context of trimming of the overall aircraft configuration.

Gust Loads

For the definition of discrete gust loads, two approaches are common: the so-called 1-cosine-gust, solved by dynamic analysis, and the so-called Pratt gust, a steady approximation of the dynamic gust phenomenon. While dynamic simulations are required for transport aircraft certified according to CS-25, the Pratt gust is still much in use in conceptual and preliminary aircraft design and can be used for aircraft certification according to CS-23.

The goal of the activity was to assess the fidelity and achieve understanding of the differences between the approaches. The investigations described in the following paragraphs have been undertaken by the Institute of Aeroelasticity, using MSC.NASTRAN.

The Pratt equation is based on the following assumptions:

- the aircraft is rigid,
- the flight speed remains constant,
- the aircraft flies in a steady and trimmed state before hitting the gust,
- the only degree of freedom is the heave,
- lift is generated by the wings; the lift generated by the fuselage and empennage can be neglected,
- the gust speed is constant over the wing span and parallel to the vertical axis.

Pratt derived his equation for a gust length of 25 times the chord length. For a simple wing example performed in iLOADS, the load factor generated by the Pratt equation proved indeed to be identical to the maximum load factor of a 1-cosine-gust.

For a complete aircraft, the result of such a comparison depends on the gust length. For the D150 configuration, the maximum load factor of all gust lengths fits the Pratt assumption well, see Figure 4 for the example of a vertical gust. However, when the gust length excites a

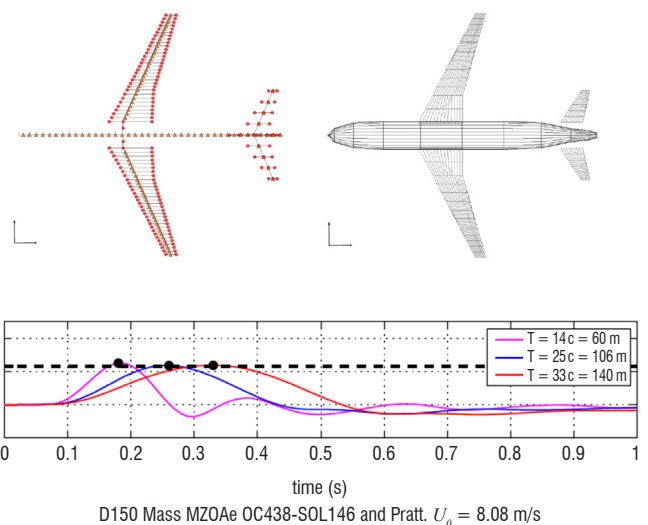

Figure 4 – Top: condensed structural model and DLM model of DLR-D150 used for gust analysis; bottom: comparison of the Pratt gust and 1-cos-gusts for different gust lengths

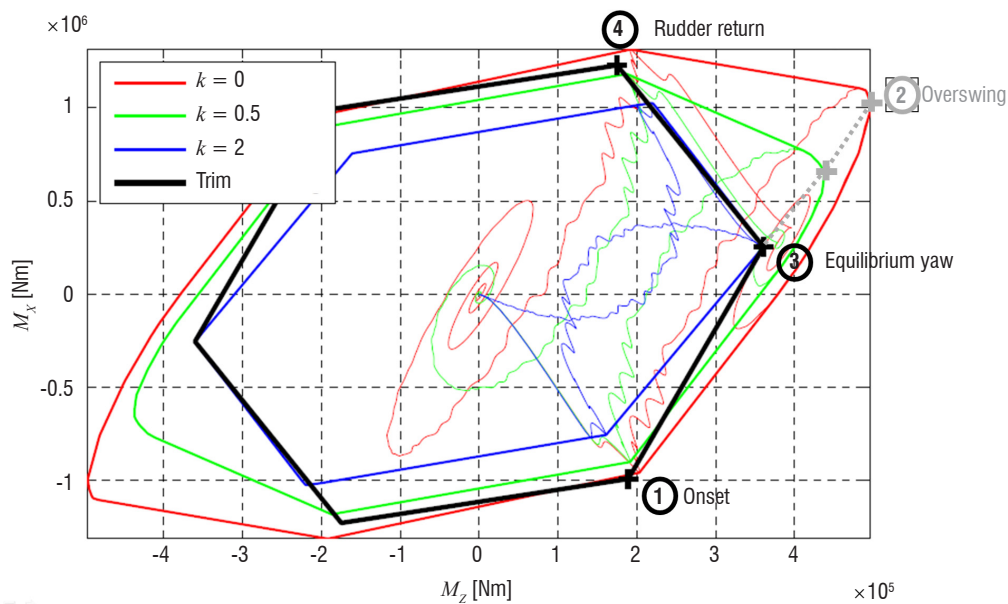

Figure 5 – Yaw maneuver: resulting loads (at the root of the vertical tail plane) for dynamic simulation and representative static analyses

natural frequency of the aircraft, e.g., the first wing bending mode, maximum load factors can be higher than predicted by the Pratt equation. Such an effect could be seen on the D150 configuration for lateral gust loads.

Manoeuvre Loads and the Effect of a Flight-Control System on Aircraft Dynamic Loads

Many manoeuvre loads can be represented as so-called trim cases. One question is whether a (steady) trim case can correctly represent all loads arising in a dynamic manoeuvre. In the work package, a dynamic yaw and dynamic roll manoeuvre have been investigated by the Institute of System Dynamics and Control.

Dynamic yaw

According to Paragraph CS 25.351, the dynamic yaw manoeuvre is defined in four phases:

1. In the cockpit, the rudder is rapidly pushed to the limit stop while the aircraft is in horizontal flight.
2. The aircraft yaws and will overswing into a maximum yaw angle.
3. After the transient is damped out, the aircraft will fly in steady slip with full rudder.
4. From this condition, the rudder is rapidly brought into the normal position.

A flight-control system has to be considered.

Rather than performing a dynamic simulation, representative trim calculations can be performed. Phases 1, 3 and 4 can be well represented by a trim calculation. Phase 2 is highly dynamic, and loads from overswing can only be calculated correctly by a dynamic simulation, see Figure 5. The figure shows bending and torsional moment at the root of the vertical tail plane [3]. If a yaw damper is used, it has a significant influence on the overswing loads, as can be seen in Figure 5, where different colors represent different yaw damper (k) settings.

Dynamic Roll

Maximum loads from a dynamic roll manoeuvre heavily depend on the pilot model used. A pilot model is necessary, since a constant load factor during the manoeuvre, as required by the regulations, cannot be obtained without such a model.

The steady roll and the two accelerated roll conditions can be specified as trim conditions. The resulting correlated load envelopes, for bending and torsional moment at a wing station just inboard of the aileron, for right and left roll, are depicted in Figure 6. The trim results compare well to the dynamic solution, except for the onset condition. This can be attributed to the "structural" dynamic overswing during the abrupt initialization of the roll manoeuvre. The resulting sharp peaks for the accelerated rolling conditions 1 and 3 are due to the very aggressive application of the ailerons. The remaining differences are a consequence of the inability to hold the appropriate load factor.

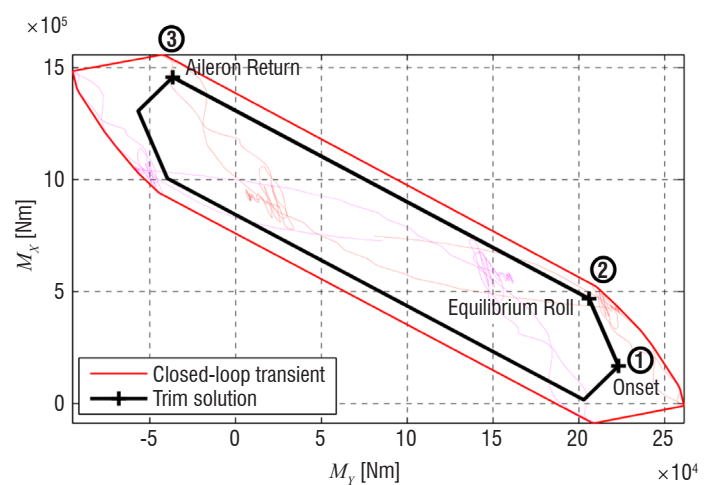

Figure 6 – Roll maneuver: correlated loads (just inboard of the aileron) for dynamic simulation compared to trim results

Ground Loads

There are two widely used approaches for the calculation of aircraft ground loads, empirical methods and simulation-based methods. Empirical methods are statistical approaches, based on data of existing aircraft. There are three major formulations for this method, which are given by Lomax [15], Howe [17] and Roskam [36]. These formulations determine the ground loads on each landing gear by first calculating equivalent dynamic loads from empirical equations and then multiplying those equivalent ground loads on each landing gear by load factors according to certification requirements, usually 1.5.

More realistic dynamic landing loads (sometimes called "rational loads") can be calculated by time domain simulation of landing impacts [37]. Cases frequently used are the so-called "3-Wheel Level Landing Case" according to CS 25.479 and the "2-Wheel Tail-Down Landing Case" (CS 25.481). Multibody models of aircraft and landing gear are used for simulation.

In the work package, results from the empirical approaches and from the simulation have been compared by the Institute of Aeroelasticity to design data from the VFW 614 aircraft, as used by DLR until 2012, see Figure 7. Results of interest for the validation are the main landing gear landing (MLG) loads.

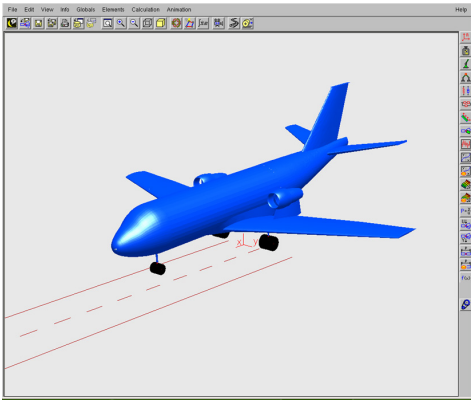

Figure 7 – Multibody model of VFW 614 aircraft used for ground load analysis

For the 2-wheel landing case, the estimated loads from all empirical methods vary no more than 5% from the values calculated by the aircraft manufacturer. The difference between the multibody simulation and the industrial data was in the same range. While a typical handbook method estimates the main landing gear attachment loads to be 6% higher than the industrial reference data, the multibody simulation result from the project is 4% lower than the reference data.

For the 3-wheel landing case, however, the empirical methods either cannot be applied or they give loads that are considerably off. The 2-wheel landing (not taking the nose landing gear into consideration) gives higher loads than the 3-wheel landing case. In addition, the VFW 614 has a conventional landing gear configuration. It may thus be concluded that the empirical methods investigated are capable of giving good estimates for maximum vertical landing loads, whereas for more realistic cases, time domain simulation, e.g., using multibody simulation, yields more reliable results. The same is true for unconventional landing gear or aircraft configurations, where statistical methods cannot yield reliable results because of the missing data base.

Loads and Structural Design

The goal of the work concerning loads and structural design was the use of results from the load analysis for the design for aircraft structures, and the assessment with respect to strength, stability, crash behavior and fatigue. A more detailed description of the work can be found in [4] and [5].

Realistic Load Assumptions for the Design of Aircraft Structures

In the project, the capabilities for the design of structures, here focused on fuselage design, were improved. For the D150 configuration, loads and a global structural design were available. However, those loads were defined on the load reference axis, thus, questions concerning a valid use of those loads for sizing of fuselage structures arise.

The geometry of the fuselage model, as well as the loads, are given in the CPACS format. The definition of the structure includes the skin with discrete reinforcements (stringers, frames), pressure bulkheads, PAX and cargo floor structure, structural coupling regions to wing and empennage models. Further considerations include material data (isotropic, orthotropic), layered compositions, as well as arbitrary profile cross-sections with arbitrary wall thickness.

Some load cases deliver local loads to the structure. One example are loads from the landing impact. Here, the global structural model has to include, e.g., a detailed representation of the wing-fuselage intersection, as well as the supporting structure of the landing gears, in order to allow a realistic load application and distribution. The Institute of Composite Structures and Adaptive Systems extended its model generator DELiS to create representative finite-element models of those areas, see Figure 8.

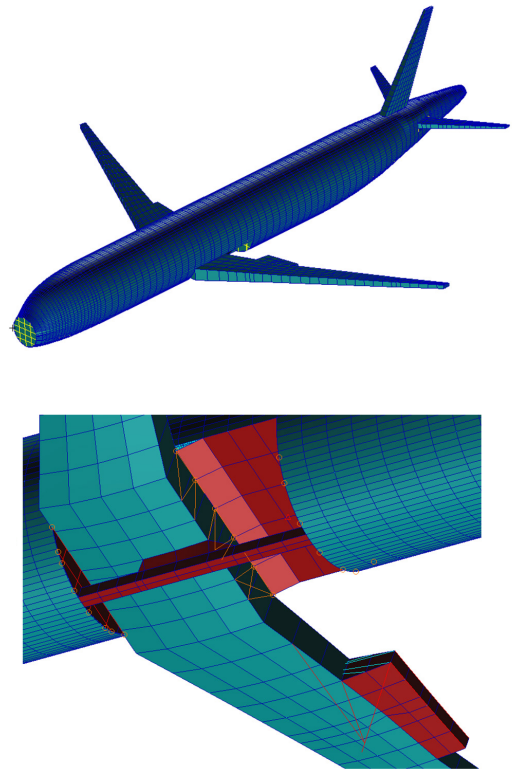

Figure 8 – Full aircraft finite-element model and detailed coupling region of the wing-fuselage intersection

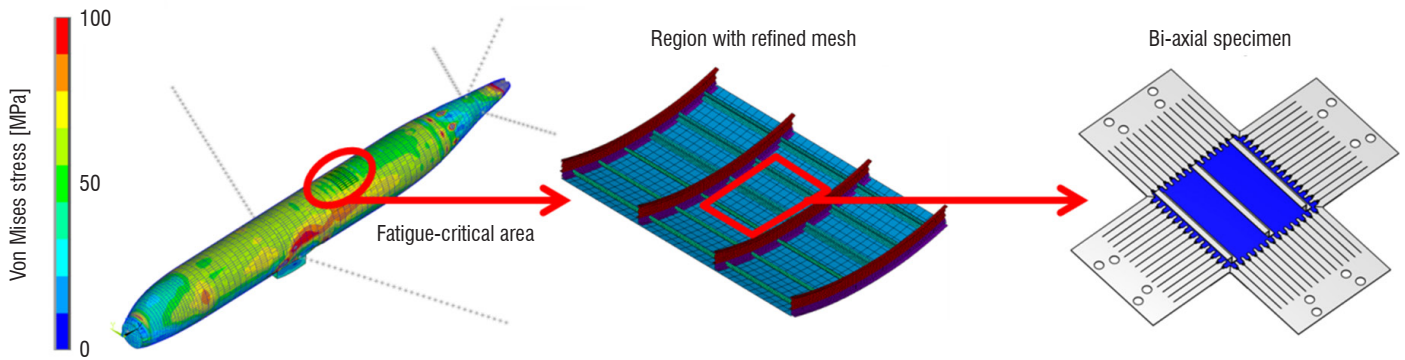

Figure 9 – Stress distribution in top fuselage at +1g flight case; red circle: fatigue-critical area

In addition, different structural sizings using either equivalent static load cases or the corresponding dynamic load cases (as described in Section "Analysis of Dynamic Loads" for gust loads, landing loads and maneuver loads) were performed and compared.

Realistic Load Assumptions for Component Design

The goal of this work package was the development of a procedure to calculate realistic loads for a fuselage panel on a full aircraft model and to use those loads for experimental investigations on test panels.

As stated above, loads given for the D150 configuration were defined on the load reference axis. Thus, different methods for the transfer of global loads, *i.e.*, shear, moment and torque given for selected points, to the distributed fuselage structure, *i.e.* the panels, have been developed and compared. The Institute of Structures and Design calculated such loads on an airframe model in the classical metallic stringer/frame design for ANSYS, built up using the DLR TRAFUMO tool, and sized by S-BOT+ as the sizing engine. For a 1g flight point, the resulting loads in a fatigue-critical area on the top of the fuselage have been derived, see Figure 9.

These loads were then passed on to the Institute of Materials Research, where the test on a bi-axial test rig was performed.

Realistic Load Assumptions for Testing Structures and Materials

The next step in the investigation was the experimental study of crack propagation for a representative fuselage section in a bi-axial test rig at the Institute of Materials Research.

The results of the load analysis described above (see Figure 9) were evaluated for the definition of test-rig loads. The stress from the simulation was taken as the maximum stress for the experiment. A load ratio of $R = \sigma_{\min} / \sigma_{\max} = 0.1$ was assumed for the fatigue test. This load ratio leads to fast fatigue crack propagation and represents ground-air-ground cycles.

The design of the bi-axial test specimen and of the forces to be applied in the experiment was performed using finite-element (FE) simulations, see Figure 10, with the software ANSYS. In the FE model, a crack can be included in order to determine stress intensity factors.

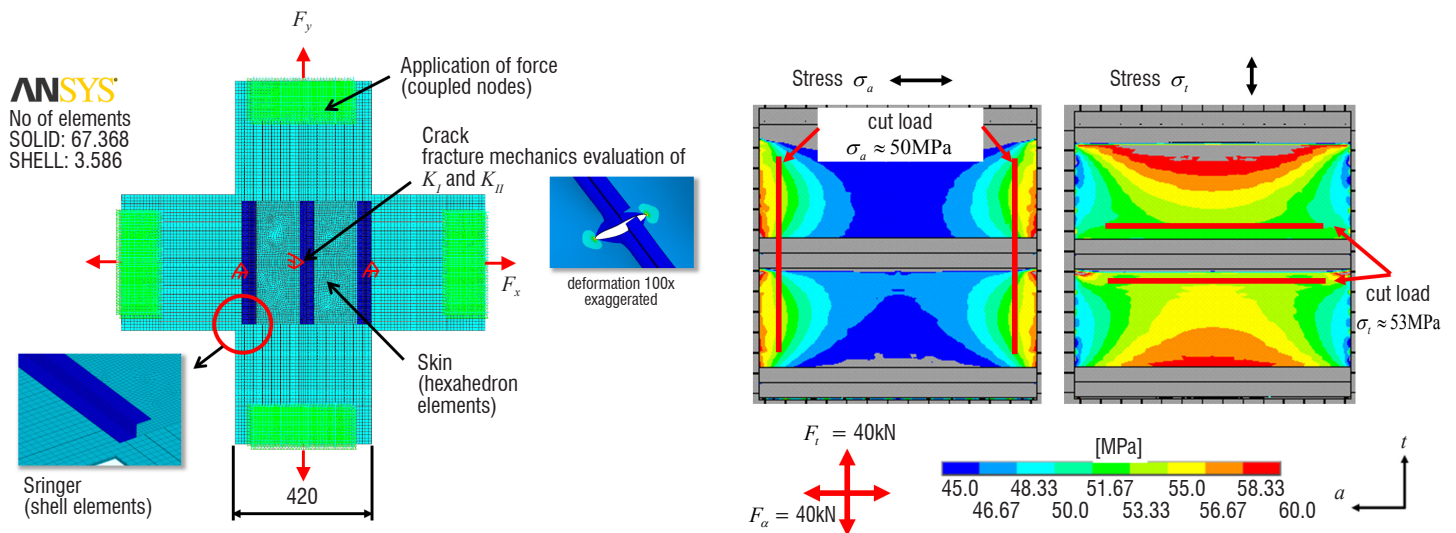

Figure 10 – FE-Model and cut loads for a bi-axial test specimen

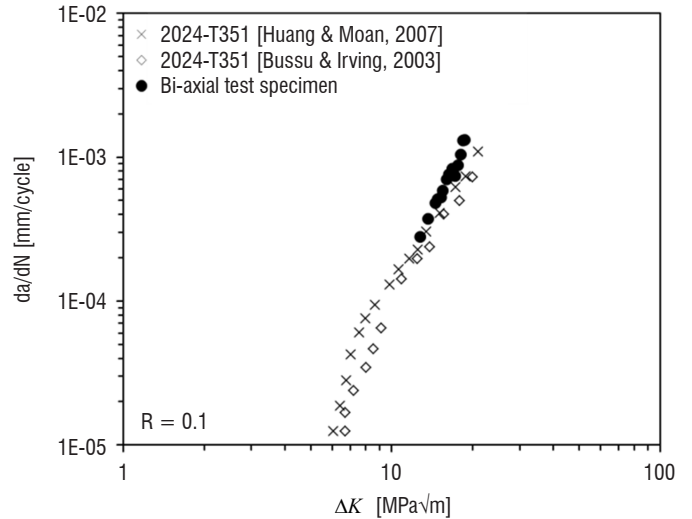
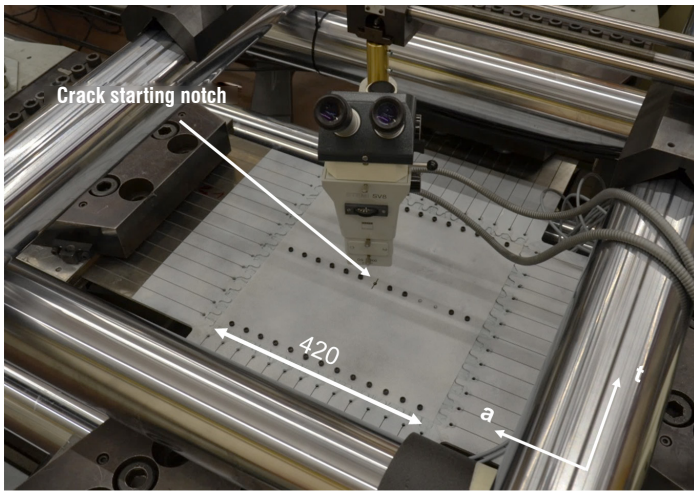

Figure 11 – Left: Test specimen in bi-axial test rig. Right: Crack growth rate for bi-axial specimen in comparison with data from literature [31], [32].

The test specimen was equipped with strain gauges in XY directions; furthermore, an optical system for deformation measurements was used. In a first experiment, the specimen was tested without a crack with different load ratios and forces up to 80 kN along both axes, see Figure 11, left. Optical measurements were employed at different force levels to compare simulation to test results.

In a second step, a notch was introduced across the riveted stringer and skin in the middle of the panel. During cyclic loading, a crack developed, which was monitored to observe the crack propagation rate (Figure 11, right) and the direction of the crack growth.

It could be shown that FE simulation can be used for the analysis of complex structures. In the future, the procedure can be performed "backwards" – with standard test-specimen crack-propagation data and numerical simulation, the resulting life time of complex structures can be predicted.

In a second test, the Institute of Composite Structures and Adaptive Systems used a panel of the fuselage section above the front door to validate their structural optimization process. This area is often sized by a braking load case leading to a compression load on the panel. Therefore, the optimization and test were focused on the prediction of the buckling behavior under uniaxial compression loads.

The panel test was performed on the Institute buckling test rig, see Figure 12. Next to strain gauges, two deflection sensors and two optical measurement systems (ARAMIS) were used for data acquisition. The ARAMIS systems covered the complete front side and most of the back side of the panel.

The respective FE simulation model is implemented using the Software Abaqus. It consists of 6-mm linear shell elements for the skin and the stringers. The top and bottom of the panel have fixed boundary conditions and the sides have free boundary conditions.

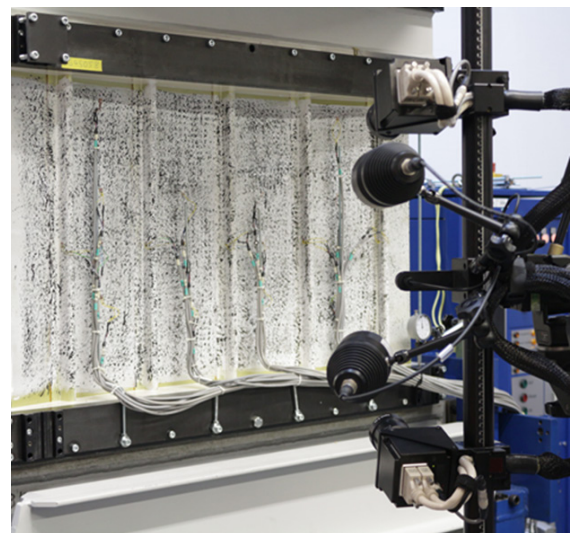
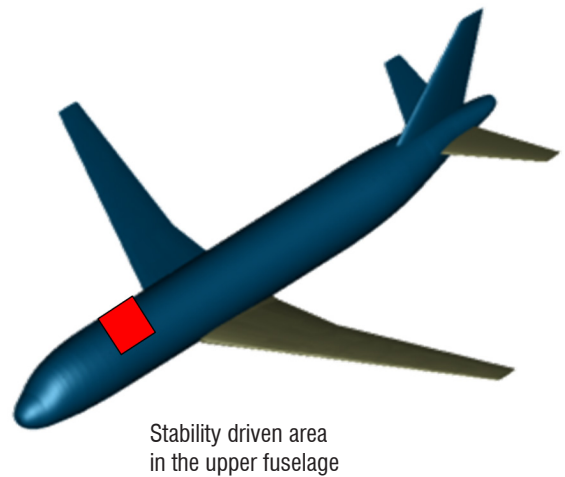

Figure 12 – Region of interest on the aircraft fuselage, and test setup for the buckling test of the panel

The experiment buckling loads are well represented in the simulation. The differences between simulation and experiment were 6.6% for the first and 3.4% for the second mode. For all modes, the buckling patterns and the global stiffness distribution of the numerical model fit the experimental result well, see Figure 13.

Use Cases: from Conceptual Design to Flight Testing

The different implementations of the load process were applied to four different applications: so-called "use cases" – a pre-design study; the generation of a load envelope for a large long-range business jet; numerical analysis and test flight of an outer wing store; and load measurements on a sailplane. Details of the activities can be found in [5], [7], and [8].

Load Analysis Process in Pre-design

The first use case was the implementation of a load process for overall aircraft pre-design applications. A load loop for pre-design was implemented in the RCE environment by DLR Air Transportation Systems. Focus was on an automated process for early design and on robustness of the process. All modules were based on CPACS, and the TiGL geometrical kernel; any valid CPACS file can be analyzed, and the main physics effects captured.

The target of these activities was to be able to perform large trade studies. Since they are needed for coupling purposes, e.g., for fluid-structure-coupling, multiple coupling schemes for mismatching topologies were evaluated. In iLOADS, the influence of aero-structural effects on sizing aircraft flexibility, and thus on performance, were of central interest.

Investigations were performed on the D150 model, see Figure 14. The overall aircraft design, including all dimensions of the aircraft geometry, results from a classical preceding conceptual design process

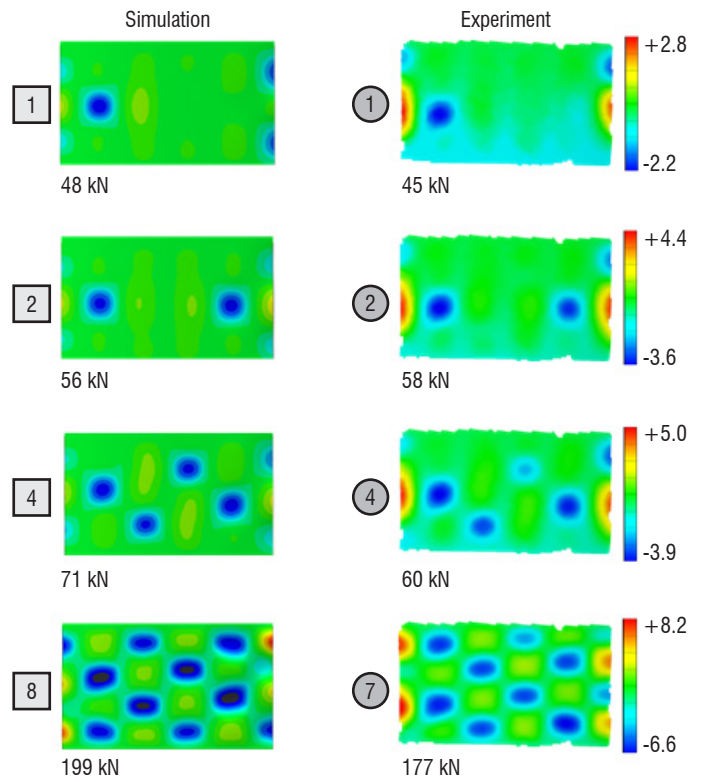

Figure 13 – Radial displacement and loads for different buckling patterns

and is taken as given for the loads and sizing loop. Analysis starts from an initial overall aircraft design (OAD) synthesis model, where the aircraft parameters are described in the CPACS format. The loads are calculated for the sizing of the airframe; a resulting deformation of the aircraft is calculated and used as input for a new load loop. After convergence, a performance analysis is performed.

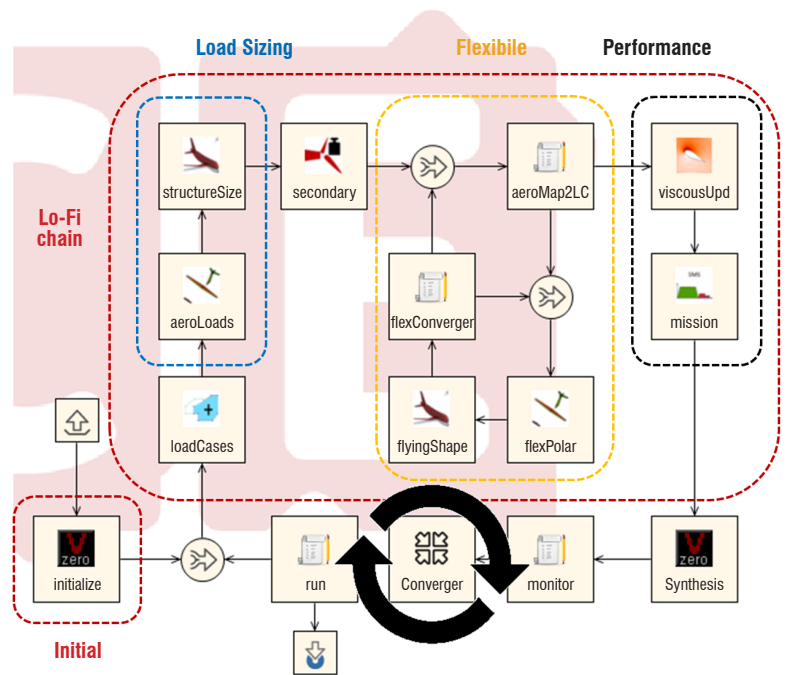
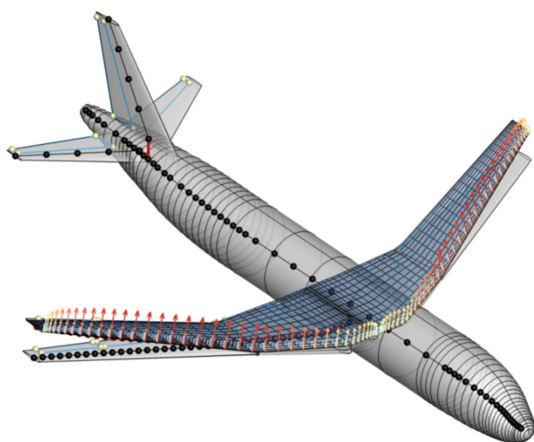

Figure 14 – D150 pre-design model and RCE-based analysis loop

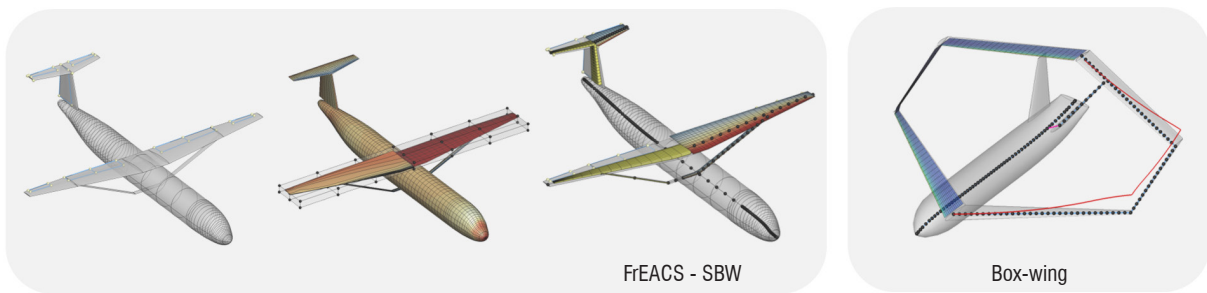

Figure 15 – Goal: reliable loads for unconventional configurations at the preliminary design stage

While the loop was tested for a conventional aircraft configuration, the final goal is to establish such a process for unconventional configurations, e.g., strut-braced wings or box-wing configurations, see Figure 15, where design trends can only be reliably predicted when taking elastic deformations into account.

Load Analysis on a High-Altitude Research Aircraft

The high-altitude research aircraft HALO, a Gulfstream G550, is operated by the DLR to provide a high-performance vehicle for atmospheric research. Test equipment can be placed in stores attached to the wings or fuselage. The DLR has to implement and certify these modifications depending on the specific mission. From aircraft certification activities for use with outer-wing stores, the DLR was provided by Gulfstream Aerospace (GAC) with load envelopes relevant for the placement of those attachments.

The second use case in iLOADS was the task of simulating those load cases with the DLR load process and with an aircraft model resulting from the DLR parametric design process. The design process used by the Institute of Aeroelasticity was the so-called MONA process, where

a parameterized aircraft model with global structural representation (finite-element model), aerodynamic (DLM) model, and mass model including various mass configurations was set up. The aim of such a design is a simulation model that represents global aircraft dynamics well for load analysis and aeroelastic stability analysis. Depending on the community, such a model is known as a "Dynamic Master Model" or a "GFEM/dynamic". The modelling process is described in [12]. Contrary to the example given in [12], however, here sizing loads were not calculated by the DLR, but rather came from the data provided by the GAC. The task of the project was to compare the loads from the DLR process with those provided by the aircraft manufacturer.

A condensed model of the aircraft was used for load analysis, see Figure 16.

Loads on wings, fuselage and empennage were compared to the values given by the GAC. First evaluations showed good agreement for most parts of the aircraft structure; differences can be seen mainly for the empennage, where the modelling should be improved, e.g., by updating the model with information gathered from ground vibration testing performed by the DLR on the HALO in 2010.

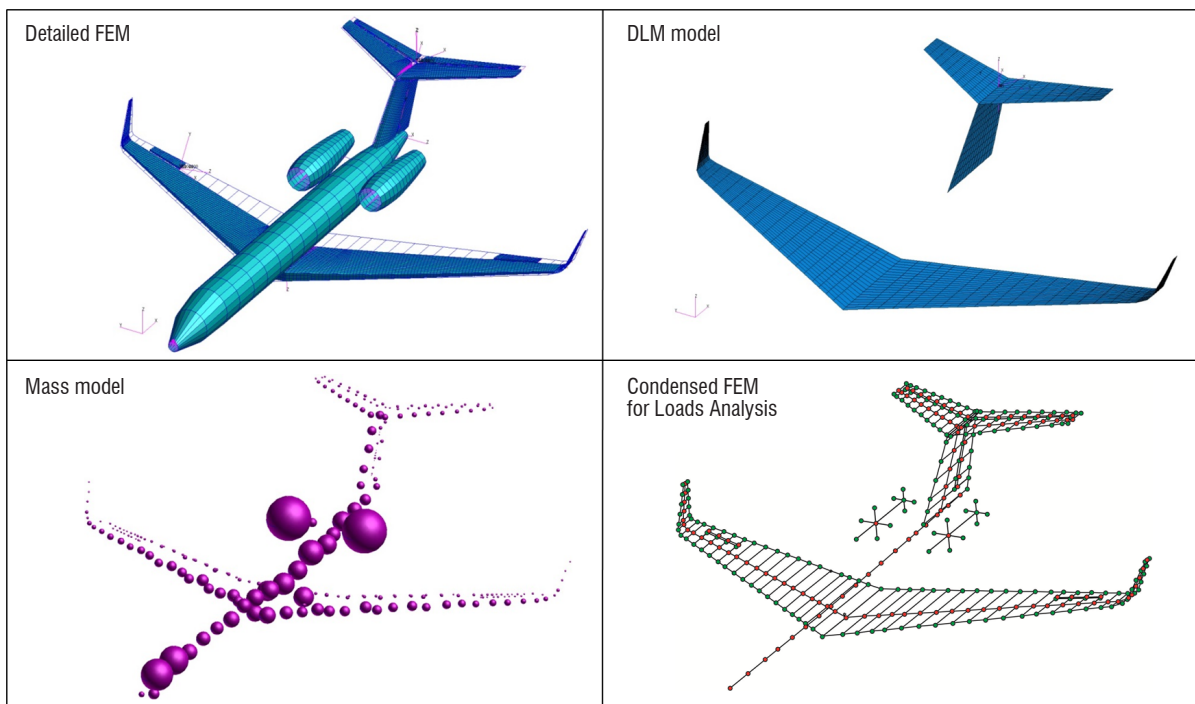

Figure 16 – Aircraft model of G550 HALO from the MONA process used for load analysis

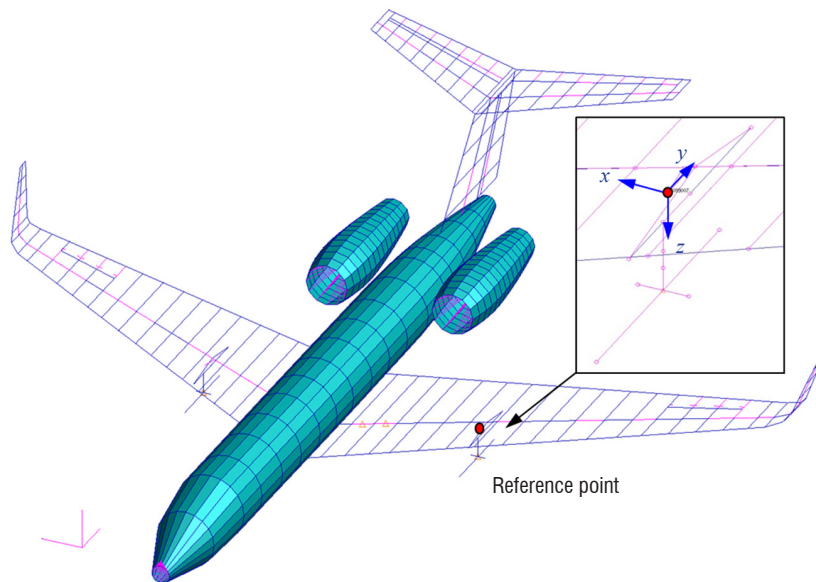

Figure 17 – Simulation of loads at the PMS attachment point

The HALO model was then used to generate realistic loads for the outer wings store, the so-called PMS (particle measurement system) - carrier, see Figure 17. For typical gust cases at $Ma=0.85$ and at an altitude of 8500 m, displacements and accelerations of the attachment point of the PMS carrier were generated. These values were later used for the hardware test of the PMS on the MAVIS vibration table at the Institute of Aeroelasticity.

Load Measurements on the HALO PMS-Carrier in Flight Tests

The PMS carrier tested is a DLR development for carrying large measurement equipment for atmospheric research under the wings of the HALO aircraft. For certification, it must be ensured that the maximum attachment loads of the carrier to the wing specified by the GAC will not be exceeded under any loading conditions or the PMS carrier. A numerical model of aircraft and carrier has been built, which must be validated through in-flight load measurements.

First, loads were calculated for the carrier, for a representative gust, by the Institute of Aeroelasticity. The PMS carrier was equipped with strain gauges and accelerometers to measure vibrations and cross-section loads close to the attachment points. The set-up was first tested on the MAVIS vibration table of the institute [38] and later installed on the HALO aircraft, see Figure 18. For the data acquisition, a de-centralized system, fitting into the central tube of the PMS carrier, was qualified for the flight tests.

In five flights, a large number of maneuvers could be flown, and an extensive amount of data was recorded. First evaluations showed promising agreement between numerical and experimental data, see [38], however, the greatest part of the evaluation is yet to be done and is part of follow-on projects. The same data set was used for online identification of the aeroelastic model of the aircraft, see [7], [38] and [39].

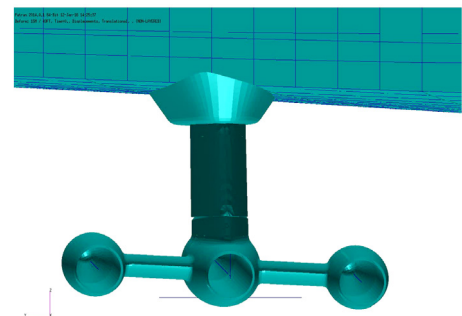

Figure 18 – PMS carrier, simulation model and hardware

In-Flight Measurements of Loads on the Discus-2c Sailplane

The Discus-2c is a research aircraft used at the DLR as a reference aircraft to validate new in-flight identification methods and to benchmark the performance of new glider designs. A special feature of the Discus-2c of the DLR is its generous storage space for measurement electronics. The fuselage and the wings are fitted with over a dozen

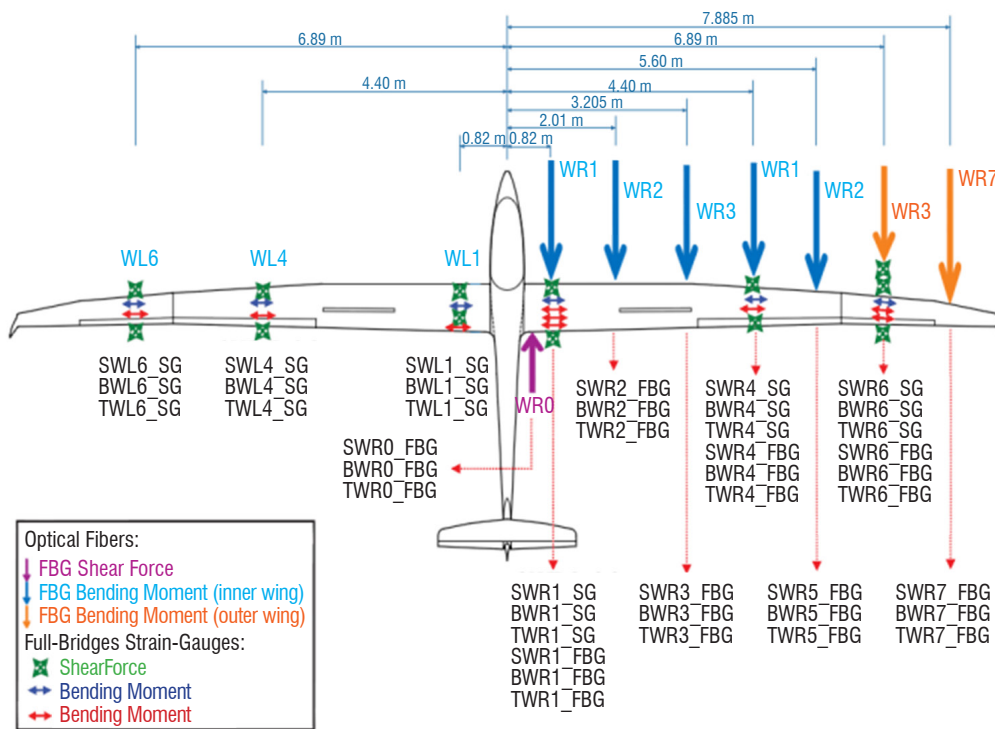

Figure 19 – Discus-2c in flight and positions of calibrated sensors for load measurements

strain gauges, designed to measure the load exerted under various flight conditions. The starboard wing also houses a fiber Bragg grating with glass fiber running along the spar. This system is used to make extremely precise wing-deflection measurements, see [40] and Figure 19.

Within the iLOADS project, an approach for in-flight load measurements has been developed by the Institute of Flight System Technology. An extensive calibration and flight-testing program was carried out. On the ground, the deflection of the wings and empennage under loads was measured with laser-interferometers at selected points. The strain gauges and Bragg grating were calibrated. In subsequent flight tests, maneuvers for longitudinal and lateral motion were performed at 396 test points in 22 flights.

With the experimental data, a real-time model for flight simulation was identified and approaches for the estimation of flight loads were developed. An integrated modelling approach takes the interaction between the rigid-body flight mechanics and structural dynamics into consideration. Simulations with the identified model show the quality of the identified model and can clearly illustrate the influence of elastic

vibration modes on the quality of the simulated aircraft response. A close description of the flight tests and the results can be found in [8], [41] and [42].

Summary and Outlook

In the iLOADS project, a comprehensive DLR internal load loop was established. The load loop profits from the extensive know-how of the DLR institutes in various load analysis fields, from numerical simulation and experimental validation to flight testing. In the project, numerical methods were investigated, experiments on test rigs were performed, and in-flight load measurements were conducted.

Work continues on several DLR projects, with a focus on component loads including high lift, an automated load loop for multidisciplinary analysis using high-fidelity methods, and applications of the load process for various conventional and unconventional configurations. Other areas of interest for future activities are a dedicated process for component loads and the introduction of fatigue loads in the aircraft design assessment ■

Acknowledgements

The authors would like to thank all members of the project team for their dedication and commitment, and namely Sunpeth Cumnuantip, Gabriel Pinho Chiozzotto, Vega Handojo, Carsten Liersch, Martin Hepperle, Eric Breitbarth, Michael Besel, Marcus Vinicius Preisighe Viana, Julian Scherer, Martin Leitner and Reiko Müller for contributions to this paper. The authors explicitly refer to the papers describing all activities in more detail. Those publications have been mentioned in the text and are included in the list of references below. The authors also thank the DLR flight-test department and the program directorate for supporting the project, and specifically the flight-test campaigns.

References

- [1] J. R. WRIGHT, J. E. COOPER - *Introduction to Aircraft Aeroelasticity and Loads*. 2nd edition, Wiley Aerospace Series, 2015.
- [2] W. R. KRÜGER, T. KLIMMEK - *Definition of a Comprehensive Loads Process in the DLR Project iLOADS*. Deutscher Luft und Raumfahrtkongress 2016, Paper ID 420105. Braunschweig, 2016. urn:nbn:de:101:1-201611183243.
- [3] S. CUMNUANTIP, T. KIER, K. RISSE, G. PINHO CHIOZZOTTO - *Methods for the Quantification of Aircraft Loads in the DLR Project iLOADS*. Deutscher Luft und Raumfahrtkongress 2016, Paper ID 420145. Braunschweig, 2016. urn:nbn:de:101:1-201612161818.
- [4] M. GEIER, D. KOHLGRÜBER, J. SCHWINN, E. BREITBARTH - *Definition und Anwendung eines Lastenprozesses zur Ableitung realistischer Bauteiltests im DLR-Projekt iLOADS*. Deutscher Luft und Raumfahrtkongress 2016, Paper ID 420219, Braunschweig, 2016. urn:nbn:de:101:1-201610075554.
- [5] J. SCHWINN, D. KOHLGRÜBER, E. BREITBARTH, M. BESEL - *Biaxiale Versuche an rumpfstrukturnahen Proben mit realistischen Lastannahmen*. Deutscher Luft- und Raumfahrtkongress 2016, Paper ID 420154, Braunschweig, 2016. urn:nbn:de:101:1-201609303582.
- [6] T. KLIMMEK, P. D. CIAMPA, V. HANDOJO, P. OHME, M.V. PREISIGHE VIANA - *Aircraft Loads - An Important Task from Pre-Design to Loads Flight Testing*. Deutscher Luft- und Raumfahrtkongress 2016, Paper ID 420223, Braunschweig, 2016. urn:nbn:de:101:1-201703036117.
- [7] J. SINSKE, Y. GOVERS, V. HANDOJO, W.R. KRÜGER - *HALO Flugtest mit instrumentierten Außenlasten für Aeroelastik- und Lastmessungen im DLR Projekt iLOADS*. Deutscher Luft und Raumfahrtkongress 2016, Paper ID 420276. Braunschweig, 2016. urn:nbn:de:101:1-201609303750.
- [8] P. OHME, C. RAAB, M. V. PREISIGHE VIANA - *Lastenmessung im Flugversuch und Entwicklung echtzeitfähiger Simulationsmodelle*. Deutscher Luft- und Raumfahrtkongress 2016, Paper Nr. 0052, Braunschweig, 2016.
- [9] T. PFEIFFER, E. MOERLAND, D. BÖHNKE, B. NAGEL, V. GOLLNICK - *Aircraft Configuration Analysis Using a Low-Fidelity, Physics Based Aerospace Framework under Uncertainty Considerations*. Proc. 29th Congress for the Aeronautical Sciences, St. Petersburg, Russia, 2014.
- [10] W.R. KRÜGER, T. KLIMMEK, R. LIEPELT, H. SCHMIDT, S. WAITZ, S. CUMNUANTIP - *Design and Aeroelastic Assessment of a Forward-Swept Wing Aircraft*. CEAS Aeronautical Journal, 5 (4), pp. 419-433. Springer Vienna, 2014. DOI: 10.1007/s13272-014-0117-0.
- [11] J. NEUMANN, H. MAI - *Gust Response: Simulation of an Aeroelastic Experiment by a Fluid-Structure Interaction Method*. Journal of Fluids and Structures 38, pp. 290-302, April 2013. DOI: 10.1016/j.jfluidstructs.2012.12.007.
- [12] M. LEITNER, R. LIEPELT, T. KIER, T. KLIMMEK, R. MÜLLER, M. SCHULZE - *A Fully Automatic Structural Optimization Framework to Determine Critical Design Loads*. Deutscher Luft- und Raumfahrtkongress 2016, Paper ID 420186, Braunschweig. urn:nbn:de:101:1-201611041880.
- [13] W. R. KRÜGER, A. BERARD, R. DE BREUKER, K. HAYDN, M. REYES - *Adaptive Wing: Investigations of Passive Wing Technologies for Loads Reduction in the CleanSky Smart Fixed Wing Aircraft (SFWA) Project*. GREENER AVIATION 2016, Brussels, Belgium, 11-13 Oct., 2016.
- [14] AeroGust (Aeroelastic Gust Modelling). <http://www.aerogust.eu>. Last visited 20-04-2018.
- [15] T. L. LOMAX - *Structural Loads Analysis Theory and Practice for Commercial Aircraft Structural Loads Analysis: Theory and Practice for Commercial Aircraft*. AIAA Education Series, Washington, 1996.
- [16] F. M. HOBLIT - *Gust Loads on Aircraft: Concepts and Applications*. AIAA Education Series, Washington, 2001.
- [17] H. HOWE - *Aircraft Loading and Structural Layout*. AIAA Education Series, Washington, 2004.
- [18] Federal Aviation Administration, Airworthiness standards - Transport category airplanes, FAA, 14 CFR Part 25, 2010.
- [19] European Aviation Safety Agency, Certification Specifications for Large Airplanes CS-25, ED Decision 2010/O13/R (2010).
- [20] M. NEUBAUER, G. GÜNTHER - *Aircraft Loads*. RTO/AVT Lecture Series on "Aging Aircraft Fleets: Structural and Other Subsystem Aspects". RTO-EN-015-09, 2000.
- [21] E. MOERLAND, T. ZILL, B. NAGEL, H. SPANGENBERG, H. SCHUMANN, P. ZAMOV - *Application of a Distributed MDAO Framework to the Design of a Short- to Medium-Range Aircraft*. 61th German Aerospace Congress (DLRK), Berlin, Germany, 2012.
- [22] O. BRODERSEN - *Drag Prediction of Engine-Airframe Interference Effects Using Unstructured Navier-Stokes Calculations*. Journal of Aircraft, Vol. 39, No. 6, 2002.
- [23] DLR-Aircraft Fleet: <http://www.dlr.de/dlr/en/desktopdefault.aspx/tabid-10203/>. Last visited 20-04-2018.
- [24] ANSYS: <http://www.ansys.com/Products/Structures>. Last visited 20-04-2018.
- [25] MSC.NASTRAN: <http://www.mscsoftware.com/de/product/msc-nastran>. Last visited 20-04-2018.
- [26] T. GERHOLD - *Overview of the Hybrid RANS Code TAU*. MEGAFLOW-Numerical Flow Simulation for Aircraft Design, edited by Kroll, N. and Fassbender, J. K., Vol. 89 of Notes on Numerical Fluid Mechanics and Multidisciplinary Design, Springer, Berlin and Heidelberg, Germany, pp. 81-92, 2005.
- [27] J. HOFSTEE, T. KIER, C. CERULLI, G. LOOYE - *A Variable, Fully Flexible Dynamic Response Tool for Special Investigations (VarLoads)*. International Forum on Aeroelasticity and Structural Dynamics, 2003.
- [28] T. FÜHRER, C. WILLBERG, S. FREUND, F. HEINECKE - *Automated Model Generation and Sizing of Aircraft Structures*. Aircraft Engineering and Aerospace Technology: An International Journal, Vol. 88, Iss: 2, pp. 268-276, 2016. DOI: 10.1108/AEAT-02-2015-0057.

- [29] J. SCHERER, D. KOHLGRÜBER, F. DORBATH, M. SOROUR - *A Finite Element based Tool Chain for Structural Sizing of Transport Aircraft in Preliminary Aircraft Design*. Deutscher Luft- und Raumfahrtkongress 2013, Stuttgart, DocumentID: 301327.
- [30] HyperSizer: <http://hypersizer.com/>. Last visited 20-04-2018.
- [31] X. HUANG, T. MOAN - *Improved Modeling of the Effect of R-Ratio on Crack Growth Rate*. International Journal of Fatigue, 29, pp. 591-602, 2007.
- [32] G. BUSSU, P. IRVING - *The Role of Residual Stress and Heat Affected Zone Properties on Fatigue Crack Propagation in Friction Stir Welded 2024-T351 aluminium joints*. International Journal of Fatigue, 25, 77-88, 2003.
- [33] German Aerospace Center (DLR): *CPACS – A Common Language for Aircraft Design*. <https://software.dlr.de/p/cpacs/home/>. Last visited 20-04-2018.
- [34] K.-H. HORSTMANN - *Ein Mehrfach-Traglinienverfahren und seine Verwendung für Entwurf und Nachrechnung nichtplanarer Flügelanordnungen*. Ph.D. Dissertation, Technical University of Braunschweig, Braunschweig, Germany, 1987; see also: Tech. Rep. FB 87-51, DFVLR, Braunschweig, Germany, 1987.
- [35] VSAERO: <http://www.ami.aero/software-computing/amis-computational-fluid-dynamics-tools/vsaero/> Last visited 20-04-2018.
- [36] J. ROSKAM - *Airplane Design Part IV: Layout Design of Landing Gear and Systems*. Roskam Aviation and Engineering Corporation, Kansas, 1986.
- [37] W. KRÜGER, M. MORANDINI - *Recent Developments at the Numerical Simulation of Landing Gear Dynamics*. CEAS Aeronautical Journal, 1 / 2011 (1-4), pp. 55-68, Springer, 2011.
- [38] W. R. KRÜGER, V. HANDOJO, T. KLIMMEK - *Flight Loads Analysis and Measurements of External Stores on an Atmospheric Research Aircraft*. 58th AIAA/ASCE/AHS/ASC Structures, Structural Dynamics, and Materials Conference. AIAA SciTech Forum and Exhibition 2017, 9-13 January 2017, Grapevine, Texas. DOI: 10.2514/6.2017-1828.
- [39] G. JELICIC, J. SCHWOCHOW, Y. GOVERS, J. SINSKE, R. BUCHBACH, J. SPRINGER - *Online Monitoring of Aircraft Modal Parameters during Flight Test based on permanent Output-only Modal Analysis*. 58th AIAA/ASCE/AHS/ASC Structures, Structural Dynamics, and Materials Conference. AIAA SciTech Forum and Exhibition 2017, 9-13 January 2017, Grapevine, Texas, USA. DOI: 10.2514/6.2017-1825.
- [40] Discus-2C DLR: http://www.dlr.de/dlr/en/desktopdefault.aspx/tabid-10203/339_read-9181/#/gallery/8791. Last visited 20-04-2018.
- [41] M. V. PREISIGHE VIANA - *Time-Domain System Identification of Rigid-Body Multipoint Loads Model*. American Institute of Aeronautics and Astronautics (AIAA). Atmospheric Flight Mechanics Conference. Paper AIAA-2016-3706, Washington D.C., United States of America, June 2016. <http://dx.doi.org/10.2514/6.2016-3706>.
- [42] M. V. PREISIGHE VIANA - *Sensor Calibration for Calculation of Loads on a Flexible Aircraft*. International Forum on Aeroelasticity and Structural Dynamics (IFASD), Paper No IFASD-2015-042, Saint Petersburg, Russia, 2015.

AUTHOR



Wolf Krüger obtained the Engineering degree in mechanical engineering from the Technical University of Braunschweig, Germany. From 1994 to 2004 he worked at the German Aerospace Center (DLR) at the Department for Vehicle Dynamics in Oberpfaffenhofen. In 2000, he received his Ph.D. degree in Aerospace Engineering at the University of Stuttgart, Germany. Since 2004, Wolf Krüger works at the DLR Institute of Aeroelasticity in Göttingen, where he is heading the Department for Loads Analysis and Aeroelastic Design. He is a professor for Multibody Dynamics in Aerospace at the Technical University of Berlin where he also teaches Aeroelasticity. Wolf Krüger's research interests include multibody dynamics, aircraft loads analysis, aircraft ground dynamics and multidisciplinary simulation.



Pier Davide Ciampa works as a research assistant at the DLR Institute of System Architectures in Aeronautics in Hamburg, Germany.



Martin Geier received his Diploma degree in mechanical engineering with specialization in the field of aerospace engineering from the TU Braunschweig, Germany in 2011. He is currently a research assistant at the German Aerospace Center (DLR) in Braunschweig working on lightweight structure design within the preliminary aircraft design process.



Thimo Kier: After receiving a Master's degree from the University of Washington, Seattle, USA and a Dipl.-Ing. degree from University of Stuttgart, Germany, Thimo Kier worked for Fairchild Dornier GmbH in the loads department on the 728 aircraft development program. In 2002 he joined the German Aerospace Center (DLR). Currently, he holds the position as a group leader of the Flight Dynamics and Loads team at the Institute of System Dynamics and Control. His research interests focus on Multidisciplinary Aircraft Model Integration for Loads Analysis and Flight Dynamics Simulations.



Thomas Klimmek is research scientist and team leader at DLR Institute of Aeroelasticity in Göttingen. He received his Diploma in Mechanical Engineering in from the University of Siegen in 1997 and his Ph.D. from the Technical University of Braunschweig in 2016. His research is focused on aeroelastic design using structural and multidisciplinary optimization methods and the loads analysis for aircraft configurations.



Dieter Kohlgrüber graduated from University of Stuttgart in 1993 and got the diploma degree in aeronautical engineering. He joined DLR Institute of Structures and Design (BT) with the focus on crash research on aircraft structures and later also on predesign of aircraft structures. Currently he is team leader on aircraft predesign and deputy head of the department "Structural Integrity" of the Institute BT.



Per Ohme graduated in Aerospace Engineering from TU Berlin in 2006 and joined the DLR Institute of Flight Systems in the same year. He worked as research engineer in the fields of flight mechanics, aircraft performance, flight data analysis, aircraft system identification, modelling and simulation. In 2010 he became leader of the modelling and simulation team and gathered experience as manager of several research cooperations with industry and other scientific institutions. From 2011 to 2016 he was manager of two comprehensive research projects related to aircraft icing. Since 2017 he is acting head of the flight dynamics and simulation department.



Kristof Risse studied aerospace engineering at RWTH Aachen University. In 2016, he received the Ph.D. degree for his dissertation on overall aircraft design with hybrid laminar flow control. After his work in a joint contract between the German Aerospace Center (DLR) and Airbus on the design of wing and movables, he is now in charge of the DLR Virtual Product House in Bremen and coordinates the field "digitisation in aeronautics" for the DLR executive board.



Julian Schwinn joined the Institute of Materials Research at the German Aerospace Center (DLR) in Cologne in 2011. His research interests focus on fracture mechanics, mechanical testing with supporting finite element simulation, especially biaxial testing of aluminium alloys and fibre metal laminates for aerospace applications. He received the diploma degree of mechanical engineering at the University of Paderborn.