



HAL
open science

Support for Decision Making in Design of Composite Laminated Structures. Part 1: Parametric Knowledge Model

Gilberto Fontecha Dulcey, Xavier Fischer, Pierre Joyot, Georges Fadel

► **To cite this version:**

Gilberto Fontecha Dulcey, Xavier Fischer, Pierre Joyot, Georges Fadel. Support for Decision Making in Design of Composite Laminated Structures. Part 1: Parametric Knowledge Model. Applied Composite Materials, 2019, 10.1007/s10443-018-9741-x . hal-01929130

HAL Id: hal-01929130

<https://hal.science/hal-01929130>

Submitted on 24 May 2023

HAL is a multi-disciplinary open access archive for the deposit and dissemination of scientific research documents, whether they are published or not. The documents may come from teaching and research institutions in France or abroad, or from public or private research centers.

L'archive ouverte pluridisciplinaire **HAL**, est destinée au dépôt et à la diffusion de documents scientifiques de niveau recherche, publiés ou non, émanant des établissements d'enseignement et de recherche français ou étrangers, des laboratoires publics ou privés.



Distributed under a Creative Commons Attribution 4.0 International License

Support for Decision Making in Design of Composite Laminated Structures. Part 1: Parametric Knowledge Model

Gilberto Fontecha Dulcey^{1,2,3}  · Xavier Fischer^{1,2} · Pierre Joyot^{1,2} · Georges Fadel⁴

¹ I2M CNRS UMR 5295, Université de Bordeaux, ENSAM, Esplanade des Arts et Métiers, 33400 Talence, France

² École Supérieure des Technologies Industrielles Avancées – ESTIA, Université de Bordeaux, technopole izarbel, 64210 Bidart, Aquitaine, France

³ Universidad Pontificia Bolivariana, Km 7, Autopista Piedecuesta, Bucaramanga, Colombia

⁴ Department of Mechanical Engineering, Clemson University, Fluor Daniel Building, Clemson, SC 29634, USA

Abstract

The design process of laminated composites faces two challenges: the engineer designs the product and its morphology, but also, simultaneously, the material. The number of design solutions can be huge since the solution space is very large. Standard CAE systems (CAD, Finite Element Simulation) do not offer to the designer an approach to explore design spaces easily handling design parameters that are intrinsic to the laminate structures: number of plies, layers' constitutive laws, visco-elastic capacity of the matrix and volume fraction of fibers. This paper provides a new model of behavior making explicit these design parameters. This Parametric and reduced Behavior Model (PRBM) allows engineers to make rapid simulations of the product they are creating. Integrated in a meta-model of Knowledge, it is combined to usual specific knowledge that are typically the domain of composite experts and manufacturing experts. Our PRBM is made from a separated numerical method, next enabling (1) a multiscale approach: the engineer can implement reasoning either at the scale of the fiber, or at the scale of the ply, at the scale of the plies interfaces, at the scale of the lamination or at the scale of the structure, or, (2) a multiphysical approach: the engineer can independently manage the mechanical effect of each ply and each interface, either in static or dynamic cases; in the latter, the creeping behavior can be considered. Two simple cases are presented to illustrate the relevance of the PRBM when simulating composite structures: one under a static load and the having a dynamic behavior.

Keywords Separated behavior model · Multiscale vs multiphysical approach · Reduced and parametric model · Layer-by-layer simulation · Qualification of simulation model · Laminate composite structure · Meta-modelling of knowledge

✉ Gilberto Fontecha Dulcey
gilberto.fontecha-dulcey@u-bordeaux.fr; gilberto.fontecha@upb.edu.co

Nomenclature

E	Young's modulus (MPa)
E_f	Fiber Young's modulus (MPa)
E_m	Matrix Young's modulus (MPa)
E_l	Young's modulus of the ply in the direction of the fibers (MPa)
E_t	Young's modulus of the ply in a direction transversal to the fiber direction (MPa)
F_y, F_z	External forces (N)
$F(\omega)$	Force as a function of frequency (N)
B	Body force
G	Shear modulus (MPa)
ν	Poisson's ratio
l	Length (mm)
h	Height (mm)
w	Width (mm)
u	Displacement in direction x
v	Displacement in direction y
w	Displacement in direction z
ε	Strain tensor
σ	Stress Tensor (Pa)
σ_{ij}	Stress tensor element (Pa)
F_0	Objective function
ς, ξ, ψ	(Weights)
L_{max}	Maximum deformation to the direction y
$U_{x,y,z,p_1,p_2,\dots,p_d}$	Approximation of displacement field (mm)
$U(x, y, z, p_1, p_1, \dots, p_d)$	Displacement field as a function of given parameters (mm)
C	Tensor of material properties in local coordinates
n	Number of enrichment modes in PGD sense
\bar{C}	Tensor of material properties in global coordinates
$\bar{C}(p_1), \bar{C}(p_2), \bar{C}(p_3), \bar{C}(p_4)$	Tensor of material properties at plies 1, 2, 3, 4 in global coordinates
C_{int}	Tensor of material properties at the interfaces
D	Transformation matrix
ρ	Density (kg/m ³)
ρ_f	Fiber density
ρ_m	Resin density
Ω	Geometric domain
θ_i	Fiber orientation of ply i (degrees)
V_f	Fiber volume fraction (%)
G_0	Short term shear modulus (GPa)
G_∞	Long-term shear modulus (GPa)
α	Fractional derivative order
τ	Decay time (s)
$X, Y, Z, P_1, P_2, P_3, P_4, P_5,$ P_6, P_7	PGD functions
$x,y,z,p_1,p_2,p_3,p_4,p_5,p_6,p_7$	PGD domains
T_{max}	Maximum twist

1 Introduction

The design of products based on metals lead the designer to explore a limited and discrete space of possibilities regarding the problem of material choice. Indeed, the material is one of the first choices being realized well before the dimensioning phase. In contrast, the design process of laminated composites is different: the designer must make decisions at the same time on the product morphology and the composite structure. In other words, the designer is not only defining the morphology of the product but he must simultaneously design the product and the material. Therefore the amount of acceptable combinations becomes vast.

Usual CAE systems (CAD, Finite Element Simulation) do not offer to the designer any solution that could allow the engineers to have a separate and multi-scale view of the composite structure:

- 1 At the level of the structure; where the number of layers determines the stiffness of the structure,
- 2 At the level of the layer: it leads the engineer to separately consider the ply because fibers orientation can lead to a different behavior,
- 3 At the level of the interface: it has consequences during dynamic behavior due to the viscosity property of the matrix,
- 4 At the level of the fiber: the fiber properties lead the engineer to decide on the fiber material and the volume rate of fibers in each ply.

The mismatch in material properties represents a significant difficulty when performing design of laminated composites. Typically, the simulations are simplified in the finite element analysis to keep the computational time and cost affordable, but that analysis must remain at the macroscale level.

Instead, in this work, we present a reduced behavioral model allowing fast reconstruction of full 3D displacement fields at the level of the plies and the interfaces between plies. Additionally, the reduced model is parametric within predefined intervals; the displacement field is a function of critical design parameters: the number of layers, the number of plies, the fiber angle, the fiber volume fraction and the viscoelastic nature of the interfaces. In our paper titled Support for Decision Making in Design of Composite Laminated Structures; Part 2: Reduced Parametric Model-Based Optimization [10], published by the journal of Applied Composite Materials, we present a way to support decision making during laminated composite structure design using our Parametric Knowledge Model (PKM). Two simple cases are presented to illustrate the flexibility of the approach when representing the behavior of composite structures: one involving a static load and the other using a force oscillating over time.

2 Multiscale Modelling of Composite Structures: From Simulation to Support in Design

In a typical design of laminated composites structures procedure, the process begins with the selection of fiber and matrix, then the fiber volume fraction, the number of plies and the orientation of each ply and stacking sequence are determined. From the mechanical point of view, the Finite Element (FE) method is used primarily to compute the displacement field and

global stress state. Many researchers addressed the simulation and the design of laminated composite structures.

When an engineer is designing a metallic material based product, his main problem is to define the shape and the condition of mechanical components assembly that will ensure he aimed mechanical behavior. In the situation of design of laminated composite material based product, the process is really different: further on the problem of product topology, there is the problem of the material design. To design a material is consisting in determining material properties that act on different scale of the product. The mechanical behavior of the product is hence determined by the product shape and by all constitutive laws that were created at each layer. The designer is in a situation of multiscale design.

Yet, the multiscale systems have being studied largely. The book edited by Soutis C and Beaumont P.W.R. [28] is presenting a good overview of the problems that are encountered by people interested in the problem of composite structure design. Most of these authors are regarding the problematic of damage prediction inner the laminated structures:

- The damage may occur at the level of interfaces between the plies: Galiotos et al. [12] are proposing a specific criteria to locate the risk of delamination,
- The damage may start either with the cracking of the fibers or inner the matrix: McCartney [21] and Soutis et al. [29] have presented some micro-mechanical in order to locate the origin of the damage

Some authors consider that, in laminated structures, the damage can be uncertain (Bogdanor et al. [3]). Even if it is often the consequence of a cyclic behavior (Hosseini et al. [14]), the damage leads to some major problems of material integrity that are occurring during the material design process (Beaumont [2]). Finally the problem of damage may be modelled by a micro-mechanical approach (Wang [30] and Darko [8]).

Beyond the interest of damage prediction, a good way to avoid the damage is consisting in providing to engineers some virtual solutions to support the design of non-damageable laminated structure. To achieve such objective, some authors present new parametrized models of behavior that explicitly characterize the design choices that are realized at different level of the structure. These models can be processed through an optimization approach in order to lead to some stacking sequence of layers that reply to design requirements:

- Mitsunori et al. [22] and Zaho et al. [32] have proposed some analytical behavioral models that can aid to the determination of number of layers making a laminated structure; such models are continuous and do not consider the different behaviors occurring at the different scales of the structure,
- Macquart et al. [18], De Faria et al. [9] and Ghiasi et al. [13] are proposing a discrete approach to look for optimal solution; the stiffness of the final structure is the main aim of the process. It is consisting in exploring a case family built from numerical simulations; the cost linked to the construction of simulation base can be important,
- other authors are developing new ways to look for optimized stacking sequence from finite Element based models (Ranaivomiaran et al. [25], Xinxing et al. [31], Monte et al. [23]). The difficulty of using Finite Element Method lies in making explicit in the numerical model the number of layers and, in an independent way, each ply constitutive

laws (determined by the fiber volume fraction and fiber orientation). Even if the authors succeeded in realizing such numerical models, the problem of time processing is major.

In this paper, we are adhering to the previous philosophy that is consisting in parametrizing the behavioral models. But also, we are taking into account the problem of cost processing. Already, some authors have proposed to develop some reduced and separated models. First, the reduction has the advantage to make faster the simulation (Ladevèze [17]). Secondly, the separation makes possible the independent analysis of each scale of the structure (Llorca et al. [19]). Until these days, most of the authors mobilized by the problematic of separated and reduced models are mainly regarding the topic of behavioral simulation of structures and not on the problem of aid to design.

- In 2017, Sonmez [27] is listing 1007 approaches that contribute directly or indirectly to aid the engineer designing the material making a composite material based product. We noted that none optimization process based on a parametric and reduced model was developed. Moreover, most of the design problems aim at dimensioning a material that lives a static behavior. Even if some authors have developed parametrized models to represent the dynamic behavior of composite materials (Jeong et al. [15], Masoumi et al. [20], Bassam et al. [1]), all of them have supplied specialized models: none parametrized models can address both a static and a dynamic behavior. The design problem is next reduced:
- For the aim of static behavior, to the determination of the global stiffness of the material,
- For the dynamic behavior where the creeping is considered, to the study of the interface ply behavior.

The work presented in this paper positions itself in the continuity of the studies listed previously. The originality of our study is lying in:

- The development of a new separated and parametrized behavioral model of the laminated composite structure that we specifically developed from a PGD numerical method,
- The processing the previous reduced and separated model with an evolutionary optimization approach,
- The qualification of our model in term of computational time and exactitude: we compare the results to usual simulation models. Also, this qualification process allows us to validate also our optimization approach,
- proposing a new method to support decision making during laminated composite structure design; our design method is interactive.

3 Separating the Dimensions and the Behaviors to Represent a Composite Structure Differently

3.1 Mixing 1D, 2D and 3D Dimensions Inner a Composite Structure

An engineer designing a composite structure is led both to:

- Design the product morphology,
- Design the material, to allow the product have the aimed behavior.

Designing a composite structure consists of manipulating some parameters and variables that are well-known for manufacturing experts. This leads the engineers to mix 3 points of view (Fig. 1 Mixing point of view; a multiscale approach):

4 A 1D Point of View

The first choice to make is that of fibers: By choosing a fiber, the engineer is determining the essential elements that will make the constitutive law of the structure: these essential elements are represented by the Material Young Modulus and Poisson Coefficient (E_f, ν_f).

At the same time, the matrix is defined. Also, this choice will act on the final constitutive law of the structure (E_m).

5 A 2D Point of View

The fibers and the matrix being mixed are making a ply of the structure. A ply is a 2D structure. The volume fiber rate constituting the ply (V_f) and the orientation of the fibers (θ) inside the ply are defining a specific orthotropic law. These characteristics determine the capacity of a layer to react to the sollicitations with a specific behavior.

6 A 3D Point of View

The stacking of the different plies forms the Laminated Composite Structure. In our approach, we only consider mirror stacking: a symmetry plane exists with identical ply orientation on each side of the plane. The primary parameter being considered at that point of view is the number of layers (p_7).

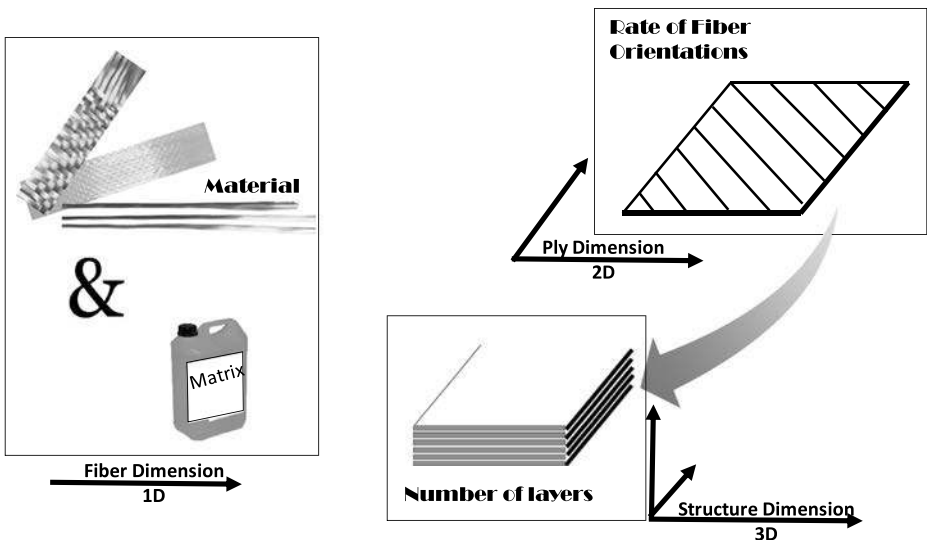

Fig. 1 Mixing point of view; a multiscale approach (fig1_Part1.JPG)

6.1 A Multi-Scale or Multi-Dimensional Approach for a Multi-Physical Approach

During the design of composite laminated structures, we aim at manipulating variables related to different scales of the structure. We propose a solution that allow the designer to explore the design spaces from an objective behavior described by the displacement field $U(x, y, z)$ that represents the movement of every element in position (x, y, z) constituting the composite structure.

The stiffness of the structure is dependent on the design choices being realized at the 1D, 2D and 3D levels. In order to allow engineer to have such approach, we propose a process that makes possible:

1. to make explicit required design parameters and variables describing a composite structure (Fig. 2 Description of the Laminated Composite Structure (LCS)) at each level or dimension of the laminated structure (1D, 2D and 3D): we developed a Separated Spatial Model (SSM). This SSM $U(x, y, z, p_1, p_1, \dots, p_d)$ describes the displacement field as a function of the d variables and parameters $p_i \ i \in \{1, \dots, d\}$ describing the structure.
2. In order to rapidly process the SSM, we developed a Proper Generalized Decomposition (PGD) approach in order to have the model in a reduced form. The reduced model, $U_{x,y,z,p_1,p_1,\dots,p_d}$, is an approximation of the real displacement field. It enables the multi-scale analysis of the design problem.
3. The SSM also leads to a separate representation of the mechanical behavior. The representation of the behavior can be provided at the level of:

Each ply; being dependent, in each ply, from its own orthotropic constitutive law,
 Each ply interface, where the matrix itself has a specific role, mainly during dynamic behavior where the creeping is significative.

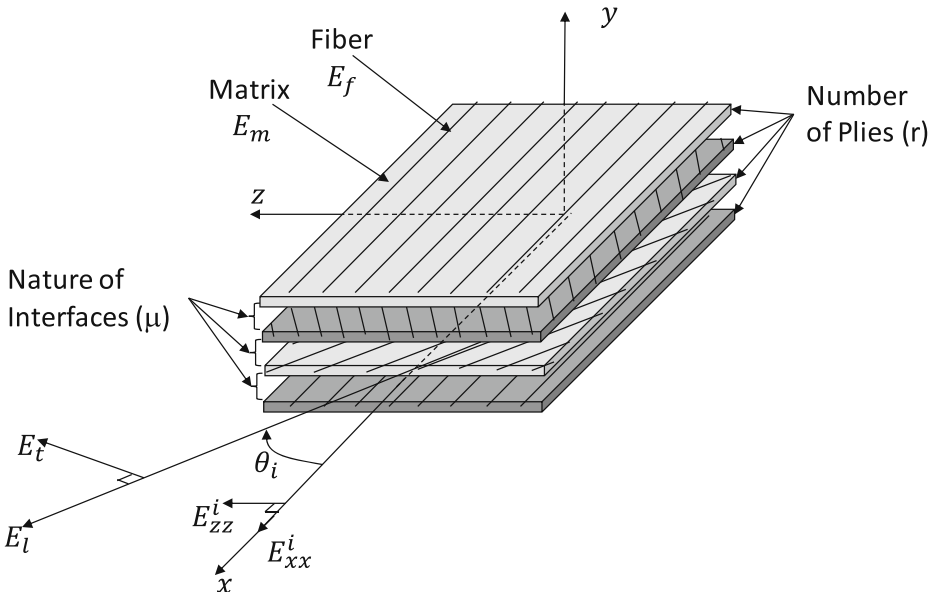

Fig. 2 Description of the laminated composite structure (LCS) (fig2_Part1.JPG)

The SSM leads to a multi-physical point of view.

The main properties of the SSM are the following (Fig. 3 A Separated Approach leading to the Parametrized and Reduced Behavior Model (PRBM)):

- 1- It is parametrized, making explicit the main element being handled during the design of the composite laminated structure, independently for each layer,
- 2- It is reduced,
- 3- It is multi-scale and multi-physical model, regarding the global behavior from the behavior occurring inside each ply and at the interface, and all could have different specificities or behavior characteristics,
- 4- It represents the behavior of the laminated composite structure either at low-scales or at the level of the product by providing a separated approximation of the displacement field.

We characterize the SSM as being a Parametrized and Reduced Behavior Model (PRBM) being useful to explore design spaces.

Making possible a layer by layer analysis allows highlighting the behavior of the interfaces between plies that produce altogether a zig-zag effect [26] as shown in Fig. 4 Zig-zag shearing on a lamination. This effect, consisting in a 2D-3D point of view, was analyzed by Carrera [5]. His aim was to create shell finite elements being able to represent this phenomena [6]. However, a selection of an appropriate function through the thickness has to be done by the designer before the simulation. Instead, thanks to our BRPM, we run 3D simulations able to handle the zig zag discontinuities caused by the mismatch of material properties by itself.

7 Towards the PRBM: A Numerical Process Making Explicit Design Parameters

7.1 Knowledge Model or Meta-Model

The objective of this work is to run an optimization problem to find the best compromise between deformation and number of plies in a laminated composite material plate under a given load, taking into consideration the material properties mismatch between plies. To carry

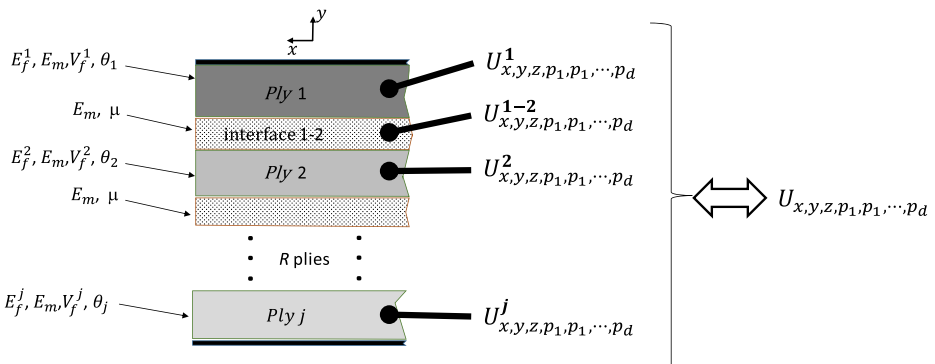

Fig. 3 A Separated approach leading to the parametrized and reduced behavior model (PRBM) (fig3_Part1.JPG)

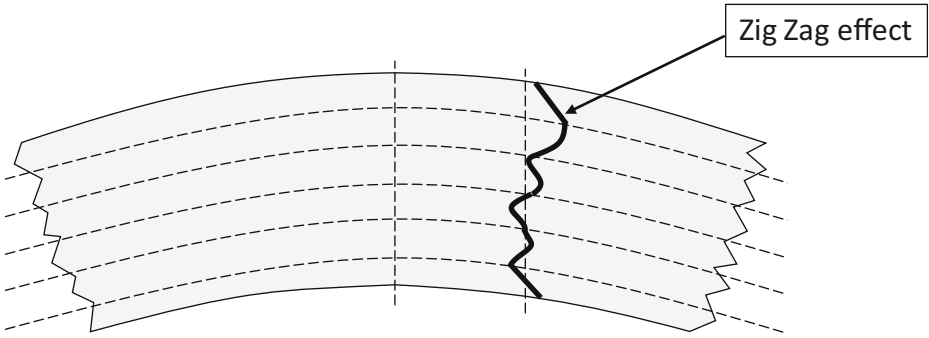

Fig. 4 Zig-zag shearing on a lamination (fig4_Part1.JPG)

out the optimization, the problem has to be defined. Design Parameters and behavioral responses are needed and are defined as follows:

Definition

Design parameters are quantities defining instances of a composite structure. They are the quantities being handled by the designer when creating the structure (Fig. 5 Design parameters processing (The sub-indexes f and m refer for fiber and matrix)).

The behavior variables are linked to design parameters through mechanical laws for whose the different models have been specifically created or extracted from current literature.

Definition

Behavior responses are the quantities directly describing the mechanical behavior, which is determined by stresses and strains (Fig. 5 Design parameters processing (The sub-indexes f and m refer for fiber and matrix)). A second order tensor represents the stresses at each point of the domain, this tensor is also named the Cauchy's tensor and describes three values of normal stresses and three values of shear stress.

In Fig. 5 Design parameters processing (The sub-indexes f and m refer for fiber and matrix), the equations relating the fiber and matrix properties (E_f, E_m, V_f) to ply properties (E_i, E_t) are presented in following sections; similarly, the viscoelastic characteristic of the interphases is also detailed.

Variables and parameters are linked together by different behavioral laws or specific mathematical representations of experts' know-how. Together, these laws complete a knowledge model.

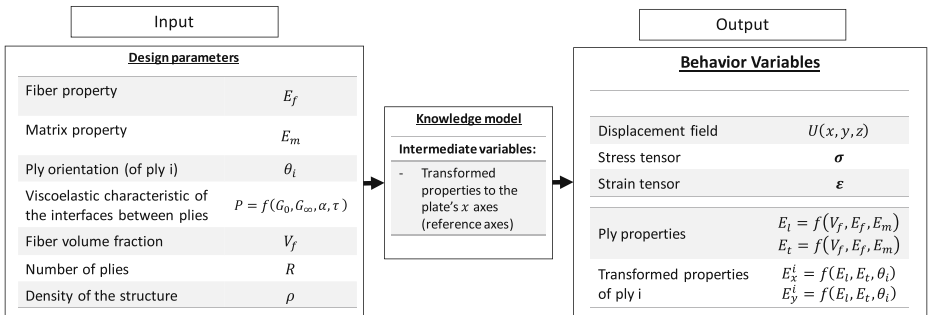

Fig. 5 Design parameters processing (The sub-indexes f and m refer for fiber and matrix) (fig5_Part1.JPG)

Definition

We name a Parametric Knowledge Model (PKM) a meta-model, a collection of models representing at the same time the behavior of a product as a function of its design parameters as well as defining the way of creation of a product.

In our case, the PKM includes (Fig. 6 Parametric Knowledge model (PKM)).

- A representation of the behavior of the laminated structure under static and then dynamic loading. It is the Parametric and Reduced Behavior Model (PRBM),
- the laws allowing to build orthotropic constitutive laws of the laminated structure.

In the following sections, we detail step by step the different elements of the knowledge model.

7.2 Parametric and Reduced Behavior Model (PRBM)

The first element of our PKM allows the measurement of the mechanical behavior of the lamination. In this work, the behavior may be static or dynamic, and our approach uses the PRBM. The governing equation is presented in eq. (1).

$$\nabla \sigma \cdot + \frac{\partial^2 U}{\partial t^2} = B \quad (1)$$

Where B are the body forces.

From this governing equation, we generate the PRBM using the Proper Generalized Decomposition (PGD) method [4, 7, 24]. The PGD method separates the spatial domains (x, y, z) into functions (X, Y, Z) on each domain from the governing equation as shown in eq. (2). Moreover, in the same equation, the model becomes parametric because the PGD method

<u>Parametric Knowledge model (PKM)</u>	
Parametric and Reduced Behavior Model (PRBM)	$U_{x,y,z,p1,p2,p3,p4,p5,p6,p7}$
Material law	$\sigma = \bar{C} \varepsilon$
Geometric law	$\varepsilon(U) = \frac{1}{2}(\nabla U + (\nabla U)^T)$
Oriented constitutive law for ply i	$E_x^i = f(E_l, E_t, \theta_i)$ $E_y^i = f(E_l, E_t, \theta_i)$
Ply constitutive law	$E_l = f(V_f, E_f, E_m)$ $E_t = f(V_f, E_f, E_m)$
Viscoelastic behavior at the interfaces	$P = f(G_0, G_\infty, \alpha, \tau)$

Fig. 6 Parametric knowledge model (PKM) (fig6_Part1.JPG)

allows the introduction of functions ($P1, P2, P3, P4, P5, P6, P7$) in additional domains ($p_1, p_2, p_3, p_4, p_5, p_6, p_7$) (Fig. 10 Parametrization of the knowledge model). These domains representing parameters are explained in a similar way to previously published work by Fontecha-Dulcey et al. [11]. Therefore, the resulting PRBM is reduced because the displacement field is no longer computed from tensor operations relating stresses and strains. Instead, the displacement field is reconstructed by adding simple Kronecker products of the functions at each enrichment mode n as shown in eq. (2). The sum of all the n PGD modes lead to the approximation of the displacement field.

$$U(x, y, z, p_1, p_2, p_3, p_4, p_5, p_6, p_7) \cong U_{x,y,z,p_1,p_2,p_3,p_4,p_5,p_6,p_7} \cong \sum_{i=0}^n U^i(x, y, z, p_1, p_2, p_3, p_4, p_5, p_6, p_7) \quad (2)$$

The term enrichment mode in the PGD method means the process of approximating the displacement field by iterating functions at each domain, using an alternative direction strategy until convergence is reached. The domains defining U are listed in Tab. 1 Domains defining the displacement field.

The functions at each domain are presented in eq. (3).

$$U(x, y, z, p_1, p_2, p_3, p_4, p_5, p_6, p_7) = \sum_{i=1}^n \{X_i(x) \circ Y_i(y) \circ Z_i(z) \circ P1_i(p1) \circ P2_i(p2) \circ P3_i(p3) \circ P4_i(p4) \circ P5_i(p5) \circ P6_i(p6) \circ P7_i(p7)\} \quad (3)$$

The symbol (\circ) stands for the Hadamard product.

In particular, applying the PGD method to our case of study, and considering a static case where the external load is constant over time, the displacement field is directly determined from the mechanical behavior law of the structure.

On the other side, when the external load changes over time we face a dynamic case, therefore the problem is solved using the Newmark's method as a time integration scheme. This incremental integration scheme is used because of the memory effect introduced by viscoelasticity. Therefore, the displacement field U is reconstructed at each time step t in a separated form of one dimensional functions in domains x, y, z .

The solution of the dynamic case also requires the density of the structure. In the lamination studied here, the density is determined from the density of the fibers ρ_f and from the density of the matrix ρ_m . We use a separated approach that leads us to consider the density ρ_m only at the level of the interfaces and the density ρ_f at the level of the plies; we do not use a mixture law, some experiments have demonstrated that this is sufficient to represent the dynamic behavior as shown in Fig. 7 Distribution of density [10].

Table 1 Domains defining the displacement field (tab1_Part1.JPG)

Domain	Description
x, y, z	Geometric domains
p_1, p_2, p_3, p_4	Parameters holding the constitutive law of the plies
p_5	Parameter handling the fiber volume fraction
p_6	Parameter handling the viscoelastic property
p_7	Parameter handling the number of plies

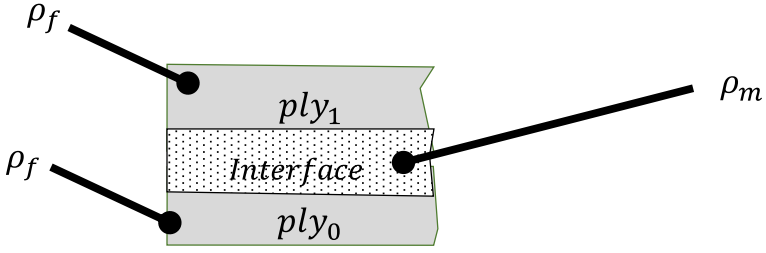

Fig. 7 Distribution of density (fig7_Part1.JPG)

All in all, in our PRBM the parameters are introduced in the orthotropic constitutive law represented by \bar{C} .

Definition

We name a parametric and reduced model, a model:

- Explicitly presenting the design parameters and the behavior variables,
- Having separated form,
- Allowing a short processing time because the reconstruction of the displacement field is based on simple Kronecker multiplications between functions.

Therefore, in the PKM, the PRBM is associated with usual laws presented as follows.

7.3 Usual Laws (UL)

From the displacement field and assuming small deformations the strain is computed from eq. (4).

$$\varepsilon(U) = \frac{1}{2} \left(\nabla U + (\nabla U)^T \right) \tag{4}$$

Moreover, from the Hooke's law we obtain the stress in eq. (5):

$$\sigma = \bar{C} \varepsilon \tag{5}$$

We call these relations ‘usual laws’ because they are typically presented in a model able to produce a single solution, but the PRBM is parametric, so it may generate solutions within the interval of parameters as follows.

7.4 Separated Representation of Orthotropy

The stacking sequence is constrained to symmetric, so the stiffness at each ply is computed as a function of the ply orientation, the principal material properties, the fiber volume fraction and the function defining the number of plies. These stiffness are specified in separated domains (p_1, p_2, p_3, p_4) as represented in Fig. 8 Parametrization of the knowledge model.

The stiffness at each ply (i) in local coordinates, considering orthotropic behavior is given by eqs. (6) and (7).

$$J = \frac{1}{1 - \vartheta_{lt} \vartheta_{tl} - \vartheta_m \vartheta_m - \vartheta_{tl} \vartheta_{lt} - 2 \vartheta_{tl} \vartheta_{tt} \vartheta_{ll}} \tag{6}$$

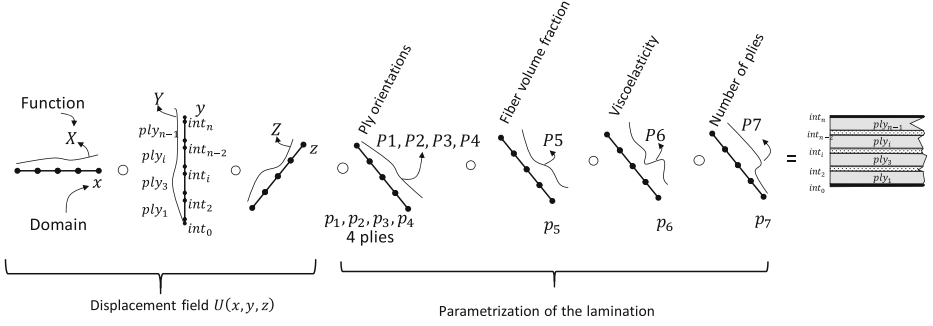

Fig. 8 Parametrization of the knowledge model (fig8_Part1.JPG)

$$[C_i] = J \begin{bmatrix} E_l(1-\vartheta_m\vartheta_m) & E_l(\vartheta_{ll}-\vartheta_{ll}\vartheta_m) & E_l(\vartheta_{ll}-\vartheta_{ll}\vartheta_m) & 0 & 0 & 0 \\ E_l(\vartheta_{ll}-\vartheta_{ll}\vartheta_m) & E_t(1-\vartheta_{ll}\vartheta_{ll}) & E_t(\vartheta_m-\vartheta_{ll}\vartheta_{ll}) & 0 & 0 & 0 \\ E_l(\vartheta_{ll}-\vartheta_{ll}\vartheta_m) & E_t(\vartheta_m-\vartheta_{ll}\vartheta_{ll}) & E_{zz}(1-\vartheta_{ll}\vartheta_{ll}) & 0 & 0 & 0 \\ 0 & 0 & 0 & G_m/J & 0 & 0 \\ 0 & 0 & 0 & 0 & G_{ll}/J & 0 \\ 0 & 0 & 0 & 0 & 0 & G_{ll}/J \end{bmatrix}^i \quad (7)$$

In the equation above, the sub-index l means the direction of the fibers, t the direction perpendicular to the fibers and m is the matrix.

Additionally, the stiffness C_i is related to the transformed stiffness \bar{C}_i in global coordinates using the transformation matrix D_i in eq. (8).

$$\bar{C}_i = D_i C_i D_i^T$$

$$D_i = \begin{bmatrix} \cos^2\theta_i & 0 & \sin^2\theta_i & 0 & 2\cdot\sin\theta_i\cdot\cos\theta_i & 0 \\ 0 & 1 & 0 & 0 & 0 & 0 \\ \sin^2\theta_i & 0 & \cos^2\theta_i & 0 & -2\cdot\sin\theta_i\cdot\cos\theta_i & 0 \\ 0 & 0 & 0 & \cos\theta_i & 0 & -\sin\theta_i \\ -\sin\theta_i\cdot\cos\theta_i & 0 & \sin\theta_i\cdot\cos\theta_i & 0 & \cos^2\theta_i-\sin^2\theta_i & 0 \\ 0 & 0 & 0 & 0 & 0 & \cos\theta_i \end{bmatrix} \quad (8)$$

On the other hand, the interfaces between plies are considered isotropic, so the stiffness is given by eqs. (9) and (10).

$$J = \frac{E}{(1+\nu)(1-2\nu)} \quad (9)$$

$$[C_{int}] = J \begin{bmatrix} 1 & -\nu & -\nu & 0 & 0 & 0 \\ -\nu & 1 & -\nu & 0 & 0 & 0 \\ -\nu & -\nu & 1 & 0 & 0 & 0 \\ 0 & 0 & 0 & 1+\nu & 0 & 0 \\ 0 & 0 & 0 & 0 & 1+\nu & 0 \\ 0 & 0 & 0 & 0 & 0 & 1+\nu \end{bmatrix}^i \quad (10)$$

The stiffness of plies and interfaces is therefore represented by eq. (11).

$$\bar{C} = f(\bar{C}_1(p_1), \bar{C}_2(p_2), \bar{C}_3(p_3), \bar{C}_4(p_4), C_{int}) \quad (11)$$

To enforce a symmetric laminate the plies are grouped as shown in Fig. 9 Description of the lamination. In this manner, the stiffness at each ply is represented by eqs. (12), (13), (14), (15), (16).

$$\bar{C}_1(p_1) = f(E_l, E_t, G_{lt}, \nu_m, \nu_{tl}, \nu_{lt}, \theta_1, Q(p_5), R1(p_7)) \quad \text{Ply group 1, made by ply 1 and ply 8} \quad (12)$$

$$\bar{C}_2(p_2) = f(E_l, E_t, G_{lt}, \nu_m, \nu_{tl}, \nu_{lt}, \theta_2, Q(p_5), R2(p_7)) \quad \text{Ply group 2, made by ply 2 and ply 7} \quad (13)$$

$$\bar{C}_3(p_3) = f(E_l, E_t, G_{lt}, \nu_m, \nu_{tl}, \nu_{lt}, \theta_3, Q(p_5)) \quad \text{Ply group 3, made by ply 3 and 6} \quad (14)$$

$$\bar{C}_4(p_4) = f(E_l, E_t, G_{lt}, \nu_m, \nu_{tl}, \nu_{lt}, \theta_4, Q(p_5)) \quad \text{Ply group 4, made by ply 4 and 5} \quad (15)$$

$$C_{int} = f(E_m, G_m, Visc(p_6), R1(p_7), R2(p_7)) \quad \text{See section 4.5} \quad (16)$$

Also, the mixture law [16] is used to introduce the variation of ply properties as a function of fiber fraction volume, fiber properties, and matrix properties, as shown in eq. (17).

$$Q(p_5) = E_m \frac{1}{(1-V_f) + \frac{E_m}{E_f} V_f} \quad (17)$$

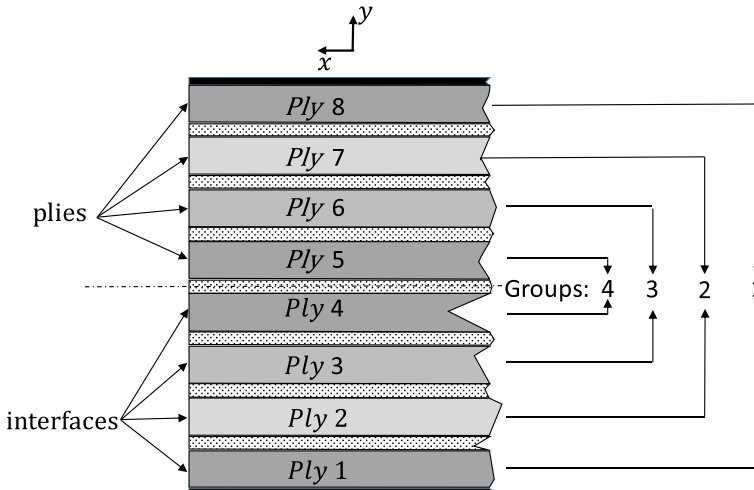

Fig. 9 Description of the lamination (fig9_Part1.JPG)

In the equation above, the sub-index f means the property of the fiber and the sub-index m means the property of the matrix.

Finally, taking into account the symmetry restriction, we restricted the number of plies to either 8 or 6 for the sake of simplicity in this work. However, the number of plies may be unlimited using the same methodology. Equations (18) and (19) are the functions in the domain p_7 modifying the number of plies.

$$R1(p_7) = \begin{cases} 1 & \text{if } r \geq 8 \\ 1 \times 10^{-14} & \text{otherwise} \end{cases} \quad (18)$$

$$R2(p_7) = \begin{cases} 1 & \text{if } r \geq 6 \\ 1 \times 10^{-14} & \text{otherwise} \end{cases} \quad (19)$$

7.5 Particularity of Viscoelasticity at Ply Interfaces

In previous work, a dynamic experiment showed that the behavior of the laminated structure is viscoelastic because the response is lagging the force excitation, this effect is shown in Fig. 10 Justification of viscoelastic response [10]. Therefore, we decided to model this behavior although it is not commonly represented in usual simulation models, so we proposed after analyzing the displacement field to consider both the phenomena of creeping and stress relaxation of the laminated structure. This behavior is modeled by the Zener's model (equation (20)), at the level of the interfaces, having as variable parameter the fractional order of the derivatives.

$$\sigma(t) + \tau^\alpha \frac{d^\alpha \sigma(t)}{dt^\alpha} = G_0 \varepsilon(t) + G_\infty \tau^\alpha \frac{d^\alpha \varepsilon(t)}{dt^\alpha} \quad (20)$$

Equation (11) is integrating for dynamic behavior an added an element named C_{int} (equation 21).

$$C_{int} = f(E_m, G_m, Visc_{p6}, R1_{p7}, R2_{p7}) \quad (21)$$

This equation contains both the elastic behavior and the viscous behavior:

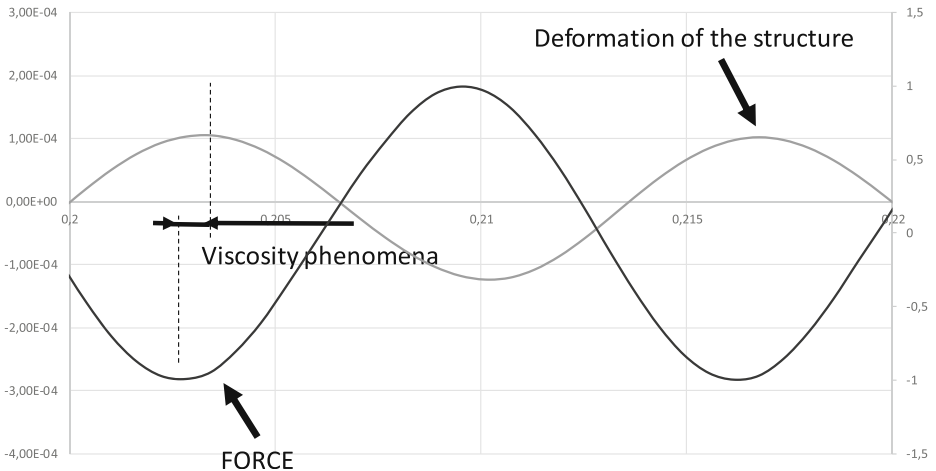

Fig. 10 Justification of viscoelastic response (fig10_Part1.JPG)

- The matrix makes the interfaces, therefore E_m , G_m represent the Young's modulus and shear modulus, both forming the elastic law of the interfaces: the interfaces have an isotropic behavior.
- $R1(p_\tau)$, $R2(p_\tau)$ are intermediate functions allowing to control the number of interfaces in the laminated structure
- The viscous parameter function P_p (equation 22) uses the discrete version of the Zener's model with fractional derivatives as presented in Fontecha-Dulcey et al. [11].

$$Visc_{p7} = \left(1 - \frac{\tau^\alpha}{\tau^\alpha + \Delta t^\alpha}\right) \frac{G_\infty - G_0}{G_\infty} \varepsilon_{xy\,ela}(t) - \frac{\tau^\alpha}{\tau^\alpha + \Delta t^\alpha} \sum_{j=1}^{N_t} w_j \varepsilon_{xy\,visc}^i(t-j\Delta t) \quad (22)$$

In this manner, the short-term shear modulus G_0 , the long term shear modulus G_∞ and the decay time τ are fixed.

$$\begin{aligned} G_0 &= 3,24 \times 10^6 \text{ Pa} \\ G_\infty &= 5 \times 10^9 \text{ Pa} \\ \tau &= 1.031 \times 10^{-7} \text{ s} \end{aligned}$$

Moreover, the fractional operator α is a parameter, the nature of the interface.

$$0 < \alpha \leq 1$$

So far we have described the different variables, parameters and models making the PKM. That PKM is used to explore the solution space during the optimization process. This process is described in the paper published by Fontecha Dulcey and al. [10] in the journal of Applied Composite Materials..

8 First Results

Our Parametric Knowledge Model such as it is presented in the fig. 6 (Fig. 6 Parametric Knowledge model (PKM)), is processed through an optimization process to support decision making during the preliminary design of laminate composite structures [10].

Nevertheless, previously the knowledge model processing, we used the Parametric and Reduced Behavior Model (PRBM) in order to simulate, either, the static and the dynamic behavior of a plate. The results are given in the fig. 11.

2 laminate composite plates, where we consider the impact of the plies interfaces behaviors, have been simulated with a Finite Element Approach (FEA) and with our PRBM:

- A 8 layers plates under a static load shows 5,5% of difference, analyzing the maximal displacement, between the FEA and the PRBM,
- A 2 layers plate under dynamic load shows 5,7% of difference.

We did not be able to realize a Finite Element Based approach for a laminate structure having more than 2 plies: the viscoelastic behavior of the interface is introducing non linearities that make impossible the explicit model to converge.

Even if, the computing time is not a criterion, when using the PRBM to simulate a static behavior, it has the advantage to be a parametric model. In the situation of dynamic behavior simulation, the PRBM becomes interesting.

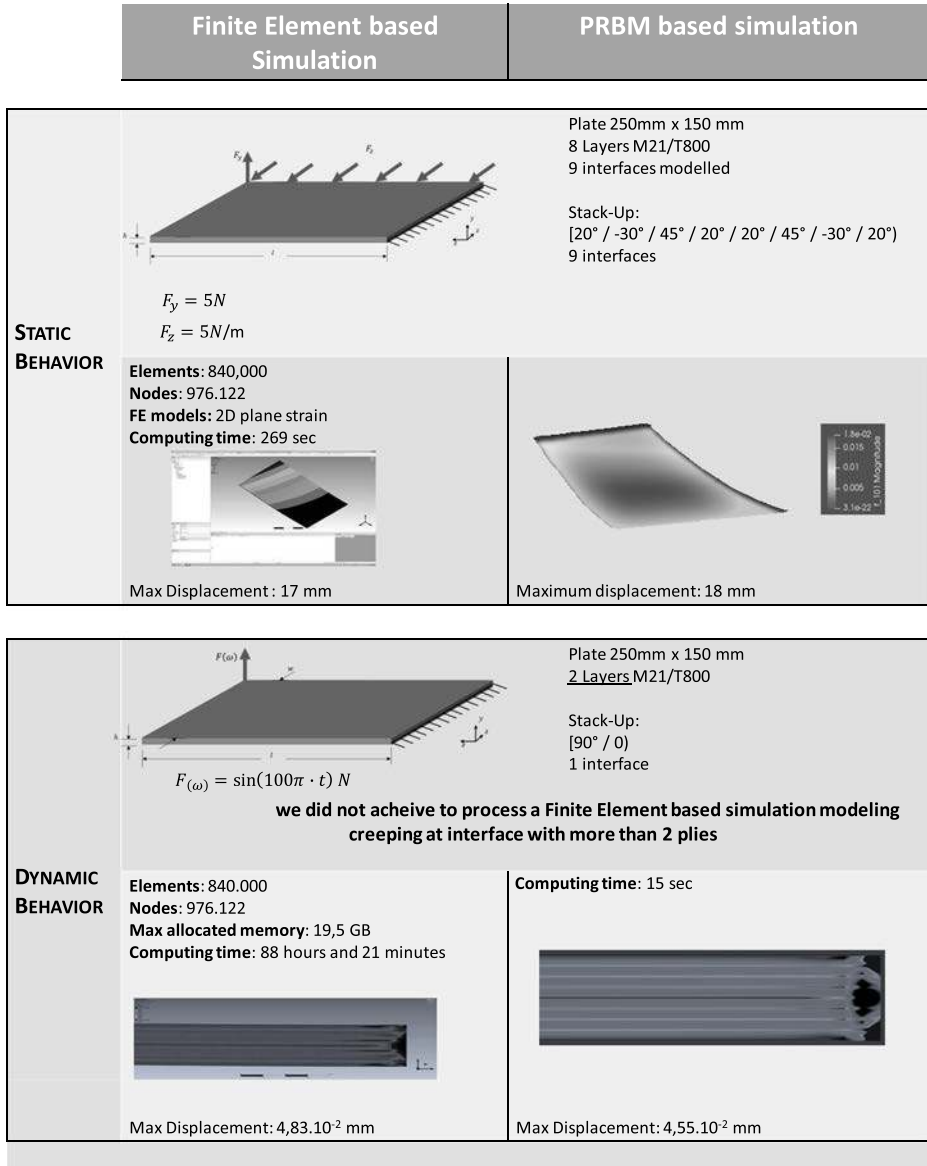

Fig. 11 Utility of the PRBM (fig11_Part1.JPG)

9 Conclusion

Knowledge that are currently handled during the design process of laminated composites was modelled: a parametric model of knowledge have been presented. We developed this model with the objective to process it having a reasonable computational cost. The knowledge model is integrated a detailed information on the behavior of the composite ply by ply; this is made possible by the reduced behavior model which is also parametrized (the PRBM). Moreover, the knowledge model also generates perspectives to

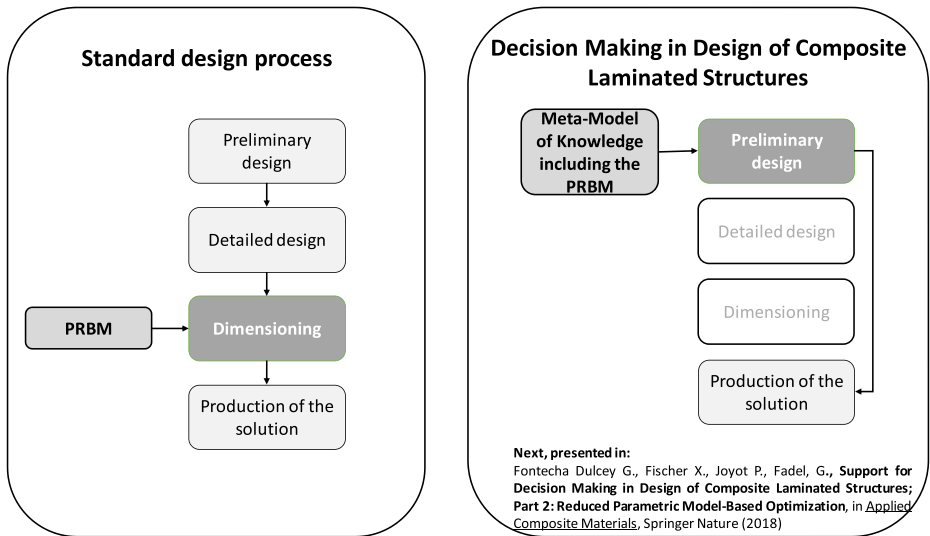

Fig. 12 Utility of the PRBM (fig12_Part1.JPG)

consider the viscoelastic nature of the interfaces to obtain particular dynamic characteristics of the laminate structure.

We also showed that the PRBM in the design of laminated composite materials is flexible because it may be used either as a regular fast solver for dimensioning in a standard design process (Fig. 12 Utility of the PRBM, left). The PRBM is one element of the meta model representing the knowledge being used during the preliminary design of laminate composite structures. In the paper titled Support for Decision Making in Design of Composite Laminated Structures; Part 2: Reduced Parametric Model-Based Optimization [10], published by the journal of Applied Composite Materials, we are detailing how to support decision making during design of composite structures (Fig. 12 Utility of the PRBM).

References

1. Bassam, E.S., Hallett, S.R.: Multiscale surrogate modelling of the elastic response of thick composite structures with embedded defects and features. *Compos. Struct.* **200**, 781–798, Elsevier (2018). <https://doi.org/10.1016/j.compstruct.2018.05.078>
2. Beaumont, P.W.R.: On the problems of cracking and the question of structural integrity of engineering. *Compos. Mater. Appl. Compos. Mater.* **21**(1), 5–43, Springer (2014). <https://doi.org/10.1007/s10443-013-9356-1>
3. Bogdanor, M., Oskay, C., Clay, S.: Multiscale modeling of failure in composites under model parameter uncertainty. *Comput. Mech.* **56**(3), 389–404, Springer (2015). <https://doi.org/10.1007/s00466-015-1177-7>
4. Bognet, B., Bordeu, F., Chinesta, F., Leygue, A., Poitou, A.: Advanced simulation of models defined in plate geometries: 3D solutions with 2D computational complexity. *Comput. Methods Appl. Mech. Eng.* **201–204**, 1–12 (2012). <https://doi.org/10.1016/j.cma.2011.08.025>
5. Carrera, E.: Theories and finite elements for multilayered, anisotropic, composite plates and shells. *Arch. Comput. Methods Eng.* **9**, 87–140 (2002). <https://doi.org/10.1007/BF02736649>
6. Carrera, E., Pagani, A.: Multi-line enhanced beam model for the analysis of laminated composite structures. *Compos. Part B Eng.* **57**, 112–119 (2014). <https://doi.org/10.1016/j.compositesb.2013.09.046>
7. Chinesta, F., Leygue, A., Bordeu, F., Aguado, J.V., Cueto, E., Gonzalez, D., Alfaro, I., Ammar, A., Huerta, A.: PGD-based computational Vademecum for efficient design, optimization and control. *Archives of*

- Computational Methods in Engineering, **20**(1), 31–59 (2013, Springer). <https://doi.org/10.1007/s11831-013-9080-x>
8. Darko, Ivančević, Smojver, I.: Explicit multiscale modelling of impact damage on laminated composites – part i: validation of the micromechanical model. *Compos. Struct* **145**, Elsevier, (2016). doi:<https://doi.org/10.1016/j.compstruct.2016.02.048>
 9. De Faria, A.R.: Optimization of composite structures under multiple load cases using a discrete approach based on lamination parameters. *Int. J. Numer. Methods Eng.* **104**(9), 827–843, International Journal for Numerical method in Engineering, Wiley (2015). <https://doi.org/10.1002/nme.4941>
 10. Fontecha Dulcey, G., Fischer, X., Joyot, P.: An experiment-based method for parameter identification of a reduced multiscale parametric viscoelastic model of a laminated composite beam. *Multiscale Multidiscip. Model. Exp. Des.* (2018a). <https://doi.org/10.1007/s41939-018-0018-8>
 11. Fontecha Dulcey, G., Fischer, X., Joyot, P., Fadel G.: Support for decision making in Design of Composite Laminated Structures; part 2: reduced parametric model-based optimization. Springer Nature (2018b)
 12. Galiotis C.P.: Interfacial damage modelling of composites, pp. 33–64, A. in *Multi-Scale Modelling of Composite Material Systems 1st Edition*, Soutis C., Beaumont P W R Eds., Woodhead Publishing ISBN: 9781855739369, (2005)
 13. Ghiasi, H., Pasinin, D., Lessard, L.: Optimum stacking sequence design of composite materials part I: constant stiffness design. *Compos. Struct.* **90**(1), 1–11, Elsevier (2009). <https://doi.org/10.1016/j.compstruct.2009.01.006>
 14. Hosseini Kordkheili, S.A., Toozandehjani, H., Soltani, Z.: A progressive multi-scale fatigue model for life prediction of laminated composites. *J. Compos. Mater.* **51**(20), 2949–2960, Sage (2017). <https://doi.org/10.1177/0021998317709610>
 15. Jeong Sik, K., Arronche, L., Farrugia, A., Muliana, A., La Saponara, V.: Multi-scale modeling of time-dependent response of smart sandwich constructions. *Compos. Struct.* **93**(9), 2196–2207, Elsevier (2011). <https://doi.org/10.1016/j.compstruct.2011.03.0062011>
 16. Kwon, Y.W., Allen, D.H., Talreja, R.: *Multiscale Modeling and Simulation of Composite Materials and Structures*. Springer, New York (2008)
 17. Ladevèze, P.: Multiscale modelling and computational strategies for composites. *Int. J. Num. Method Eng.* **60**(1), 233–253, Wiley (2004). <https://doi.org/10.1002/nme.960>
 18. Macquart, T., Maes, V., Bordogna, M.T., Pirrera, A., Weaver, P.M.: Optimisation of composite structures – enforcing the feasibility of lamination parameter constraints with computationally-efficient maps. *Compos. Struct.* **192**, 605–615 (2018). <https://doi.org/10.1016/j.compstruct.2018.03.049>
 19. Llorca, J.L., Gonzalez, C., Molina-Aldareguia, J., Lopes, C.S.: Multiscale modeling of composites: toward virtual testing and beyond. *J. Min. Metals Mater. Soc.* **65**(2), 1–11 (2012). <https://doi.org/10.1007/s11837-012-0509-8>
 20. Masoumi, S., Salehi, M., Akhlaghi, M.: Nonlinear viscoelastic analysis of laminated composite plates – a multi scale approach, *Int. J. Recent Adv. Mech. Eng. (IJMECH)* 2 (2), (2013)
 21. McCartney, L.N.: Multi-scale predictive modelling of cracking in laminate composites, pp. 65–98, A. in *Multi-Scale Modelling of Composite Material Systems 1st Edition*, Soutis C., Beaumont P W R Eds., Woodhead Publishing. ISBN: 9781855739369, (2005)
 22. Mitsunori, M., Sugiyamat, Y.: Optimum design of laminated composite plates using lamination parameters. *AIAA J.* **31**(5), 921–922 (1993). <https://doi.org/10.2514/3.49033>
 23. Monte, S.M.C., Infante, V., Madeira, J.F.A., Moleiro, F.: Optimization of fibers orientation in a composite specimen. *Mech. Adv. Mater. Struct.* **24**(5), 410–416, Taylor and Francis (2017). <https://doi.org/10.1080/15376494.2016.1191099>
 24. Prulière, E., Chinesta, F., Ammar, A.: On the deterministic solution of multidimensional parametric models using the proper generalized decomposition. *Math. Comput. Simul.* **81**, 791–810 (2010). <https://doi.org/10.1016/j.matcom.2010.07.015>
 25. Ranaivomiarana N., Irisarri F.X., Bettebghor D., Desmorat B., Concurrent optimization of material spatial distribution and material anisotropy repartition for two-dimensional structures. *Continuum Mech. Thermodynam.* 1–14, , Springer, (2018). doi:<https://doi.org/10.1007/s00161-018-0661-7>
 26. Reddy, J.N. (ed.): *Mechanics of composite materials*. Springer Netherlands, Dordrecht (1994)
 27. Sonmez, F.O.: Optimum design of composite structures: a literature survey (1969–2009). *J. Reinforced Plastics Compos.* **36**(1), 3–39 (2017, Sage Journals). <https://doi.org/10.1177/0731684416668262>
 28. Soutis, C., Beaumont, P.W.R.: *Multi-scale modelling of composite material systems 1st Edition*, Woodhead Publishing. ISBN: 9781855739369, (2005a)
 29. Soutis C., Beaumont P.W.R.: *Multi-scale modelling of composite material systems: the art of predictive damage modelling*, Woodhead, (2005b)

30. Wang C.H.: Progressive multi-scale modelling of composite laminates, pp. 259–277, A. in Multi-Scale Modelling of Composite Material Systems 1st Edition, Soutis C., Beaumont P W R Eds., Woodhead Publishing, , ISBN: 9781855739369, (2005)
31. Xinxing, T.X.: Wenjie Ge, Yonghong Zha, optimal fiber orientation and topology design for compliant mechanisms with fiber-reinforced composites. Proc. Inst. Mech. Eng. C J. Mech. Eng. Sci. **231**(12), 2302–2312 (2017). <https://doi.org/10.1177/0954406216631783>
32. Zhao, J., Xueling, F., Sun, Q.: Stacking sequence optimization of composite laminates for maximum buckling load using permutation search Algorithm. Compos. Struct. **121**, 225–236, Elsevier (2015). <https://doi.org/10.1016/j.compstruct.2014.10.031>