



**HAL**  
open science

## Fixed-Wing MAV Adaptive PD Control Based on a Modified MIT Rule with Sliding-Mode Control

A. Espinoza-Fraire, Yangquan Chen, A. Dzul, Rogelio Lozano, R. Juarez

► **To cite this version:**

A. Espinoza-Fraire, Yangquan Chen, A. Dzul, Rogelio Lozano, R. Juarez. Fixed-Wing MAV Adaptive PD Control Based on a Modified MIT Rule with Sliding-Mode Control. *Journal of Intelligent and Robotic Systems*, 2018, 91 (1), pp.101-114. 10.1007/s10846-018-0856-y . hal-01928179

**HAL Id: hal-01928179**

**<https://hal.science/hal-01928179v1>**

Submitted on 29 Nov 2023

**HAL** is a multi-disciplinary open access archive for the deposit and dissemination of scientific research documents, whether they are published or not. The documents may come from teaching and research institutions in France or abroad, or from public or private research centers.

L'archive ouverte pluridisciplinaire **HAL**, est destinée au dépôt et à la diffusion de documents scientifiques de niveau recherche, publiés ou non, émanant des établissements d'enseignement et de recherche français ou étrangers, des laboratoires publics ou privés.

# Fixed-Wing MAV Adaptive PD Control Based on a Modified MIT Rule with Sliding-Mode Control

A. T. Espinoza-Fraire<sup>1</sup> · YangQuan Chen<sup>2</sup> · A. Dzul<sup>3</sup> · R. Lozano<sup>4</sup> · R. Juarez<sup>5</sup>

<sup>1</sup> Facultad de Ingeniería, Ciencias y Arquitectura,  
Universidad Juárez del Estado de Durango,  
Gómez Palacio, Durango, México

<sup>2</sup> University of California, Merced, Merced, CA 95343, USA

<sup>3</sup> TecNM/Instituto Tecnológico de la Laguna, 27000 Torreón,  
Coahuila, México

<sup>4</sup> HEUDIASYC Laboratory, Université de Technologie  
de Compiègne, Compiègne, Oise 60200, France

<sup>5</sup> Facultad de Contaduría y Administración, Universidad  
Autónoma de Coahuila, Torreon, Coahuila, México

## Abstract

This paper presents an adaptive PD control law by using a modified MIT rule. The adaptation of the controller gains is based on the adjustment mechanism of the MIT rule by the gradient method with three types of sliding-mode control, i.e., first order sliding-mode control, second order sliding-mode (2SM), and high order sliding-mode control (HOSM). The proposed adjustment mechanism with the PD controller have been designed for the altitude movement, directional and lateral dynamics of a fixed-wing miniature aerial autonomous vehicle (MAV). Several simulations have been carried out in order to analyze the response of the modified MIT rule.

**Keywords** Adaptive control · Adjustment mechanism · Sliding mode control · PD controller

## 1 Introduction

In control theory, there exist several dynamic systems possessing constant uncertain parameters or parameters varying slowly [1]. For example, when we develop an MAV (Mini Aerial Vehicle), we can add or remove sensors or batteries, then we modify the weight and consequently the inertia parameters. In the same way, when an MAV flies in bad weather, it is exposed to changes in the air density which are usually considered as a constant value. In order to solve the aforementioned problems, several control laws could be designed. One of such options is the use of an adaptive controller [2] allowing the MAV performs a stable flight under such conditions. The adaptive control has been applied in areas as the robot manipulators, airplanes, rockets, chemical process, electronic systems, ships, bioengineering and other applications [1, 3].

Exist a lot of literature about adaptive control, but in this work we are going focus in works related to the MIT rule, thus, as in [4], where it has been applied the MIT rule based on model reference adaptive control (MRAC) for the regulation of a second order system; the contribution of [4] is the modification of the MIT rule with the objective to obtain a major amplitude of reference desired, due to the MIT rule tends to be unstable with large reference values, and this is one of the inconvenient in work with the MIT rule and even more, is sensitive to big numerical changes in the adaptation gain, that is, even with decimal changes in this gain, the system tends to be unstable. In [4] only show an example to make one gain adaptable of the control law, and the other gain of the control law proposed is not adaptable (constant value).

Also, [5] the MIT rule has been applied to a distillation process, considering a linearized model, in addition to applying an adaptive feedback control for two parameters of the controller, and by considering as reference a unitary

step signal. In [6], they have presented a comparison of the MIT rule with the gradient method and by the Lyapunov method. In [6] has been designed a control law for tracking and regulation for an aspheric tank with selecting a small reference for the input, and they have not presented a modification to the MIT rule.

By other hand, [7] applied a Model Reference Adaptive Controller (MRAC) based on the MIT rule in the roll angle for a very large four engine passenger jet aircraft, the authors of [7] mentioned a very important point about the adaptation gain, that is, based on the simulation results obtained with MatLab software, with high values on the adaptation gain it is obtained a fast response on the system but with larger overshoots, and with low values of gamma the system response is slow with small overshoot. The interval of this gain is from 1 to 5 Beyond this interval the system performance is not satisfactory.

In [8] a MRAC with a LQR has been applied to stabilize a quadrotor with parametric uncertainties, this union was proposed because the authors of [8] mentioned that the adaptive control is a method for ensuring the stability of the quadrotor, but the adaptive control working alone is not ideal because fast adaptation can lead to undesirable oscillations and instability. The work presented in [9] is shown a design based on feedback linearization and adaptive control (MRAC), the controller has been applied to control the attitude of fixed-wing UAV, the control laws is applied for decoupling dynamics which defines the UAV, that are, pitch, yaw and roll angles, respectively. In [9] used the same reference for the three angles and even realized a linearization of the decoupling model.

The works mentioned at the top have shown results using the Matlab software (simulation results).

In summary in this work, we have applied the MIT rule with the sliding modes theory, the objective of this union is to obtain a robust adjustment mechanism in presence of wind gusts to change the gains of a PD controller. The union of the MIT rule with the sliding mode theory implies a first order sliding mode, and due to that with this union is presented the chattering effect, we have added a second order sliding mode in order to reduce this effect, and finally we have appreciated than the chattering effect is presented still with two sliding modes, so we have added a high order sliding mode in order to reduced the effect chattering in the design of the adaptive control. Thus, the adaptive controller obtained, is applied in order to lead the altitude movement, yaw and roll angles to a desired values.

With the union mentioned before (MIT rule with sliding mode theory), we have obtained a lower sensitivity in the adaptive gain, and it is possible to vary the reference required with different desired values, unlike the aforementioned works. Furthermore, we have proposed a different definition of the adjustment mechanism based

on the MIT rule with sign function and with sign – sign functions than the presented in [1, 3]. We also added a disturbance which acts on the process input [3], with the objective of test the robustness of the adjustment mechanism for the adaptive PD controller in presence of not modeled disturbances in the fixed-wing MAV. Such disturbances are small wind gusts, but are unknown and random.

The paper is organized as follows: Section 2 shows the equations that define the dynamical model of the MAV; in Section 3, it is presented the control law design for the fixed-wing MAV dynamics. In Section 4, is shown the simulation results and an analysis of the error signals and the efforts of the control inputs, Section 5 presents the conclusions of this work.

## 2 Airplane Model

In order to obtain the model equations, by omitting any flexible structure of the MAV, the fixed-wing MAV can then considered as a rigid body. Also, we do not consider the curvature of the earth, it is considered just as a plane because we assume that the fixed-wing MAV will only fly short distances. With the previous considerations, we obtain the model by applying the Newton's laws of motion. It should be mentioned that the model presented in this work represents a pure motion pitch to achieve the desired altitude, and the same concept of pure motion is applied to the yaw and roll angles.

### 2.1 Longitudinal Dynamics

The used dynamical model to control the altitude of the MAV is given by [10]:

$$\dot{\theta} = q \quad (1)$$

$$\dot{q} = \frac{\rho S V \bar{c}^2}{4 I_{yy}} C_{mq} q + \frac{\rho V^2 S \bar{c}}{2 I_{yy}} C_{m_{\delta_e}} \delta_e \quad (2)$$

$$\dot{h} = V \sin(\theta) \quad (3)$$

where  $V$  is the magnitude of the airplane speed (for the simulations presented in this work is considered as constant),  $\theta$  denotes the pitch angle.  $q$  is the pitch angular rate with respect to the  $y$ -axis of the aircraft body,  $h$  defines the airplane altitude and  $\delta_e$  represents the elevator deviation [10]. We can see these variables in the in Fig. 1.

### 2.2 Directional-Lateral Dynamic

The lateral dynamics generates the roll motion and, at the same time, induces a yaw motion (and vice versa), then a natural coupling exists between the rotations about the roll and yaw axes [11]. In our case, to solve it, we have

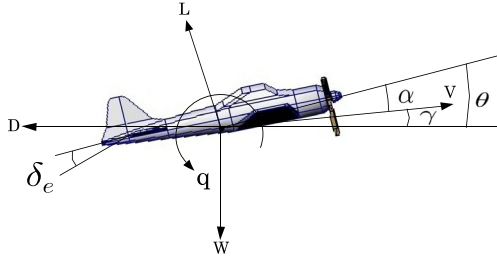


Fig. 1 Pure pitching motion

considered a decoupling of the yaw and roll angles [2]. Thus, each angle can be controlled independently. Generally, the effects of the engine thrust are also ignored [11]. In the Fig. 2, the yaw angle (directional dynamics) is represented, which can be described by the following equations:

$$\dot{\psi} = r \quad (4)$$

$$\dot{r} = \frac{\rho V S b^2}{4I_{zz}} C_{n_r} r + \frac{\rho V^2 S b}{2I_{zz}} C_{n_{\delta_r}} \delta_r \quad (5)$$

where  $\psi$  represents the yaw angle and  $r$  denotes the yaw rate with respect to the center of gravity of the MAV.  $\delta_r$  is the rudder deflection. The following equations describe the dynamics for the roll angle (lateral dynamics):

$$\dot{\phi} = p \quad (6)$$

$$\dot{p} = \frac{\rho V S b^2}{4I_{xx}} C_{l_p} p + \frac{\rho V^2 S b}{2I_{xx}} C_{l_{\delta_a}} \delta_a \quad (7)$$

where  $p$  denotes the roll rate,  $\phi$  describes the roll angle, and  $\delta_a$  represents the deviation of the ailerons. In the Fig. 3 are shown the variables of the roll motion. In Fig. 4 is shown a Solidworks model designed to calculate the moments of inertia.

*Remark 1* It should be mentioned that the mathematical model defined in this work, only represents the Euler angles and the angular rates, due to that with this approximation in the mathematical model has been obtained a good

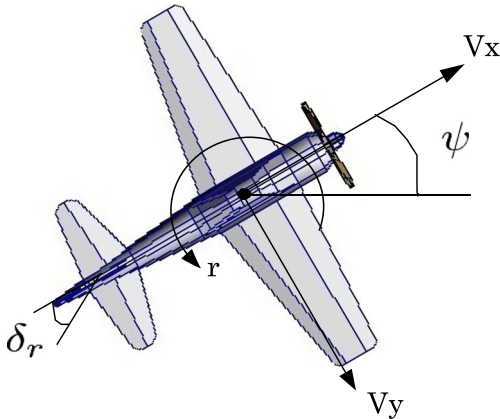


Fig. 2 Pure yawing motion

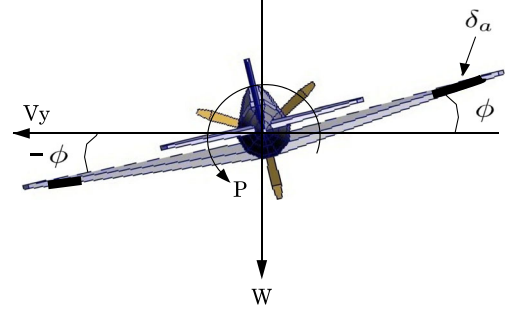


Fig. 3 Pure rolling motion

performance in real-time flight tests (see [12, 13], and [14]). And the control design presented in this work needs the knowledge of only such physical variables.

*Remark 2* The parameters of the wingspan, fuselage, etc, of the aeromodelling model T-28 Trojan, were provided by the manufacturer (<http://www.horizonhobby.com/>), see Table 1.

*Remark 3* The validation of the model has been proved with the design of the backstepping controller presented in [12] and with the design of nonlinear observers presented on [13], that is, the backstepping controller needs the complete knowledge of the model for its design process and the same situation can be considered for the design of the nonlinear observers (see [13]), otherwise it is not possible to obtain a stable flight with the fixed-wing MAV, namely, it is not possible to achieve the control objective. Therefore, in this sense, we can prove the validity of the aerodynamic model.

### 2.3 Change of Variables of the Directional-Lateral Aerodynamic Model

In order to design the adaptive control law, we have conducted a change in the variables notation for the altitude, directional and lateral dynamics; this is due to the fact that the dynamics are similar. Then, the directional dynamics is represented in the new variables by:

$$\dot{x}_{1l} = x_{2l} \quad (8)$$

$$\dot{x}_{2l} = C_{1l} x_{2l} + C_{2l} u_l \quad (9)$$

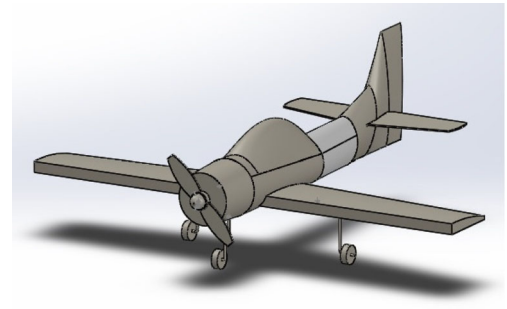


Fig. 4 SolidWorks software model

**Table 1** Fixed-wing MAV parameters

Name	Parameter	Value
Air density	$\rho$	1.05 kg/m <sup>3</sup>
Wing area	$S$	0.09 m <sup>2</sup>
Standard mean chord	$\bar{c}$	0.14 m
Wingspan	$b$	0.914 m
Moment of inertia in roll	$I_{xx}$	0.16 kg · m <sup>2</sup>
Moment of inertia in pitch	$I_{yy}$	0.17 kg · m <sup>2</sup>
Moment of inertia in yaw	$I_{zz}$	0.02 kg · m <sup>2</sup>
Dimensionless coefficient for longitudinal movement, obtained experimentally	$C_{m_q}$	-50
Dimensionless coefficient for elevator movement, obtained experimentally	$C_{m_{\delta_e}}$	0.25
Dimensionless coefficient for the yaw angle, obtained experimentally	$C_{n_r}$	-0.01
Dimensionless coefficient for the rudder movement, obtained experimentally	$C_{n_{\delta_r}}$	0.0005
Dimensionless coefficient for roll angle, obtained experimentally	$C_{l_p}$	-0.15
Dimensionless coefficient for ailerons movement, obtained experimentally	$C_{l_{\delta_a}}$	0.005
Velocity	$V$	60 km/h

with  $l := \theta, \psi, \phi$  for the pitch, roll and yaw angles, respectively. The definition of the acronym  $l$  is with the objective of known or differentiate which dynamic model is being used in the control law.  $u_l$  defines the control input, that is,  $u_\theta := \delta_e$ ,  $u_\psi := \delta_r$  and  $u_\phi := \delta_a$ . The same subindex are going to use in the description of the adaptive control presented in the Section 3.

### 3 Design of the Adaptive Control

We have designed a PD control law with adaptive gains, thus, the adaptive part of the controller is given by the proportional and the derivative gains. These gains are defined as  $\hat{k}_{pla}$  and  $\hat{k}_{vla}$  respectively. The methodology to design the adaptive control is based on the MRAS, in order to design the adjustment mechanism by the MIT rule based on the gradient method with sliding-mode theory, that is, we have modified the MIT rule based on the gradient method by inserting the theory of first order sliding-mode, second order (2-SM) and high order sliding-mode (HOSM), with the purpose of obtaining a robust adjustment mechanism for the adaptive control law and to stabilize the system in presence of unknown perturbations (wind gusts), and trying to reduce the chattering effect. The block diagram representing the MRAS proposed is shown in Fig. 5, where the *Plant* is the aerodynamic model which represents the fixed-wing MAV, and the block called as *Model* represents the model-reference.

Consider the Eqs. 8-9, The adaptive control is given by:

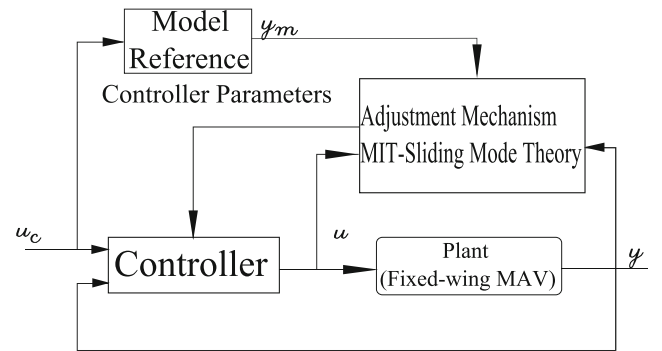
$$u_l = \hat{k}_{pla}e_l + \hat{k}_{vla}\dot{e}_l \quad (10)$$

where  $\hat{k}_{pla}$  and  $\hat{k}_{vla}$  are called as the position and velocity gains, respectively, thus, these are the adaptive gains. The

error of the directional and lateral dynamics has been defined as  $e_l = x_{1l}^d - x_{1l}$ . The gains of the PD control have implicit a subscript to indicate the algorithm that has been applied as adjustment mechanism,  $a = a_1, a_2, a_3, a_4$  where  $a_1$  corresponds to the MIT rule,  $a_2$  corresponds to the MIT rule with sliding-mode (MIT-SM),  $a_3$  uses the MIT rule with 2-sliding-mode (MIT-2SM), and finally  $a_4$  represents the MIT rule with high order sliding mode (MIT-HOSM). Therefore, for the design of the MIT rule, it is introduced an error given by:

$$e_{l_m} = x_{1l_m} - x_{1l} \quad (11)$$

where  $x_{1l_m}$  is the output from the reference model. We have followed the methodology that has been presented in [3] for the MIT rule, taking this into account, the aerodynamic model has been transformed into the representation of a transference function in order to develop the derivatives of sensitivity; these have been obtained by computing partial derivatives with respect to the controller parameters  $\hat{k}_{pla}$



**Fig. 5** Block diagram of the MRAS

and  $\hat{k}_{vla}$ . Thus, the closed-loop transfer function with the adaptive PD controller has been defined as:

$$x_{1l} = \frac{\hat{k}_{pl} C_{2l}}{s^2 + (C_{2l} \hat{k}_{vl} - C_{1l})s + C_{2l} \hat{k}_{pl}} x_{1l}^d \quad (12)$$

and the model of reference has been defined as:

$$x_{1lm} = \frac{\omega_n^2}{s^2 + 2\zeta\omega_n s + \omega_n^2} x_{1l}^d \quad (13)$$

where  $\zeta = 3.17$  and  $\omega = 3.16$ . Consider (11)–(13) and calculate the partial derivatives with respect to  $\hat{k}_{pla}$  and  $\hat{k}_{vla}$ , then it is obtained:

$$\frac{\partial e_{lm}}{\partial \hat{k}_{pl}} = \frac{C_{2l}}{s^2 + (C_{2l} \hat{k}_{vl} - C_{1l})s + C_{2l} \hat{k}_{pl}} (x_{1l} - x_{1l}^d) \quad (14)$$

$$\frac{\partial e_{lm}}{\partial \hat{k}_{vl}} = \frac{C_{2l} s}{s^2 + (C_{2l} \hat{k}_{vl} - C_{1l})s + C_{2l} \hat{k}_{pl}} (x_{1l} - x_{1l}^d) \quad (15)$$

Generally, the expressions (14) and (15) cannot be used due to the unknown parameters  $\hat{k}_{pla}$  and  $\hat{k}_{vla}$ . Thus, an optimum case has been assumed, it is defined as:

$$s^2 + (C_{1l} + C_{2l} \hat{k}_{vl})s + C_{2l} \hat{k}_{pl} = s^2 + 2\zeta\omega_n s + \omega_n^2 \quad (16)$$

thus, after these approximations, we have obtained the differential equations of the adaptive PD controller.

$$\dot{\hat{k}}_{pla_1} = -\gamma_{1l} \left( \frac{1}{s^2 + 2\zeta\omega_n s + \omega_n^2} (x_{1l} - x_{1l}^d) \right) e_{lm} \quad (17)$$

$$\dot{\hat{k}}_{vla_1} = -\gamma_{2l} \left( \frac{s}{s^2 + 2\zeta\omega_n s + \omega_n^2} (x_{1l} - x_{1l}^d) \right) e_{lm} \quad (18)$$

Now, it is proposed an MIT rule with second order sliding-mode; this approach is different than the defined in [3], and then, it is defined a sliding-mode surface as  $s_{1l} = \dot{x}_{1lm} - x_{2l} + k_{1l} e_{lm}$  (we search to increase the stability to the adjustment mechanism), where  $k_{1l} > 0$ . Then, the differential equations of the adaptive controller, with the methodology by sliding-mode, are given by:

$$\dot{\hat{k}}_{pla_2} = -\gamma_{1l} \left( \frac{1}{s^2 + 2\zeta\omega_n s + \omega_n^2} (x_{1l} - x_{1l}^d) \right) (\beta_{p1l} \text{sign}(s_{1l})) \quad (19)$$

$$\dot{\hat{k}}_{vla_2} = -\gamma_{2l} \left( \frac{s}{s^2 + 2\zeta\omega_n s + \omega_n^2} (x_{1l} - x_{1l}^d) \right) (\beta_{v1l} \text{sign}(s_{1l})) \quad (20)$$

where the gains are  $\beta_{p1l}, \beta_{v1l} > 0$ . Due to the chattering effect of the first order sliding-mode, let us design an adjustment mechanism with a second order sliding-mode. These second order sliding-mode includes a robust differentiator of first order [15]. This differentiator is defined by:

$$\begin{aligned} \dot{x}_0 &= v_0 = -\lambda_0 |x_0 - s_{1l}|^{1/2} \text{sign}(x_0 - s_{1l}) + x_1 \\ \dot{x}_1 &= -\lambda_1 \text{sign}(x_1 - v_0) \end{aligned}$$

where  $x_0$  and  $x_1$  are real-time estimations of  $s_{1l}$  and  $\dot{s}_{1l}$ , respectively. The values of  $\lambda_1, \lambda_2$  are constants and positives. Thus, the differential equations of the adaptive PD controller with a second order sliding-mode are defined by:

$$\begin{aligned} \dot{\hat{k}}_{pla_3} &= -\gamma_{1l} \left( \frac{1}{s^2 + 2\zeta\omega_n s + \omega_n^2} (x_{1l} - x_{1l}^d) \right) \\ &\quad \times (\beta_{p1l} \text{sign}(s_{1l}) + \beta_{p2l} \text{sign}(\dot{s}_{1l})) \end{aligned} \quad (21)$$

$$\begin{aligned} \dot{\hat{k}}_{vla_3} &= -\gamma_{2l} \left( \frac{s}{s^2 + 2\zeta\omega_n s + \omega_n^2} (x_{1l} - x_{1l}^d) \right) \\ &\quad \times (\beta_{v1l} \text{sign}(s_{1l}) + \beta_{v2l} \text{sign}(\dot{s}_{1l})) \end{aligned} \quad (22)$$

where the gains are  $\beta_{p1l}, \beta_{p2l}, \beta_{v1l}, \beta_{v2l} > 0$ . In order to reduce or eliminated the chattering effect in the second order sliding-mode, we have designed an adjustment mechanism with HOSM. To design the adjustment mechanism, it is necessary a robust differentiator of second order [15], which is given by:

$$\begin{aligned} \dot{x}_0 &= v_0 = -\lambda_0 |x_0 - s_{1l}|^{2/3} \text{sign}(x_0 - s_{1l}) + x_1 \\ \dot{x}_1 &= v_1 = -\lambda_1 |x_1 - v_0|^{1/2} \text{sign}(x_1 - v_0) + x_2 \\ \dot{x}_2 &= -\lambda_2 \text{sign} |x_2 - v_1| \end{aligned}$$

where  $x_0, x_1$  and  $x_2$  are real-time estimations of  $s_{1l}, \dot{s}_{1l}$  and  $\ddot{s}_{1l}$ . The values of  $\lambda_0, \lambda_1$  and  $\lambda_2$  are defined as positive constants. Finally, the differential equations of the adaptive PD controller with HOSM are defined by:

$$\begin{aligned} \dot{\hat{k}}_{pla_4} &= -\gamma_{1l} \left( \frac{1}{s^2 + 2\zeta\omega_n s + \omega_n^2} (x_{1l} - x_{1l}^d) \right) \\ &\quad \times (\alpha_{pl} [\ddot{s}_{1l} + 2(|\dot{s}_{1l}|^3 + |s_{1l}|^2)^{1/6} \\ &\quad \times \text{sign}(\dot{s}_{1l} + |s_{1l}|^{2/3} \text{sign}(s_{1l}))]) \end{aligned} \quad (23)$$

$$\begin{aligned} \dot{\hat{k}}_{vla_4} &= -\gamma_{2l} \left( \frac{s}{s^2 + 2\zeta\omega_n s + \omega_n^2} (x_{1l} - x_{1l}^d) \right) \\ &\quad \times (\alpha_{vl} [\ddot{s}_{1l} + 2(|\dot{s}_{1l}|^3 + |s_{1l}|^2)^{1/6} \\ &\quad \times \text{sign}(\dot{s}_{1l} + |s_{1l}|^{2/3} \text{sign}(s_{1l}))]) \end{aligned} \quad (24)$$

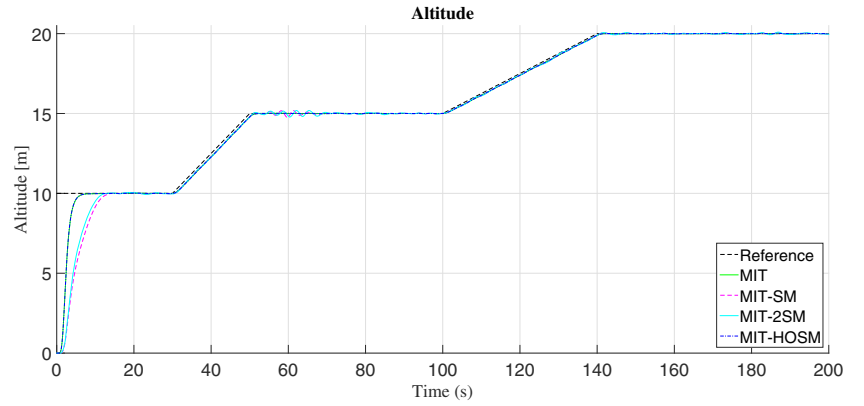
where the gains are  $\alpha_{pl}, \alpha_{vl} > 0$ .

## 4 Simulation Results

In this work we are going to use the  $\mathcal{L}_2$  - norm to describe the results obtained with the different adaptive mechanism based on the MIT rule with the sliding mode theory. Such  $\mathcal{L}_2$  - norm is applied to the error between the model reference and the aerodynamic model that describe the fixed-wing MAV, and even the same norm is applied to know the control effort. Then, the  $\mathcal{L}_2$  - norm for the error is defined as

$$\mathcal{L}_2[e_{lm}] = \sqrt{\frac{1}{T - t_0} \int_{t_0}^T \|e_l\|^2 dt} \quad (25)$$

**Fig. 6** Adaptive PD controller response in altitude movement (with disturbances)



And the  $\mathcal{L}_2$  – norm to know the control effort of the adaptive law with the different adaptive mechanisms, the  $\mathcal{L}_2$  – norm is given as

$$\mathcal{L}_2[\delta_s] = \sqrt{\frac{1}{T - t_0} \int_{t_0}^T \|\delta_s\|^2 dt} \quad (26)$$

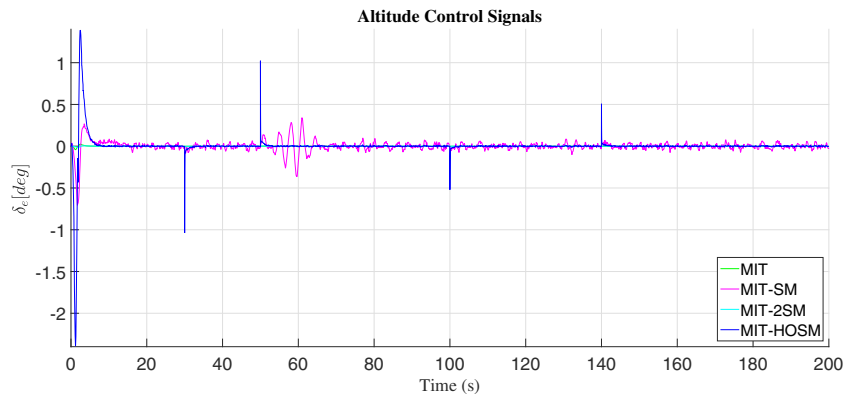
#### 4.1 Altitude Movement

In the Fig. 6 is shown the results obtain with the different adaptive mechanism designed to obtain an adaptive PD controller. In this altitude simulation, we have set different desired altitude, such altitude or control objectives are 10, 15 and 20 meters. It is appreciates at the first desired altitude (10 meters) the adaptive controller achieves the desired altitude of critically damped form, and after that, the other altitudes achieves in a soft signal due to the desired altitude signal, see the Fig. 6.

The smaller error obtained in altitude is with the adjustment mechanism based on MIT-SM, this is 7.39, 10.77 and 10.71% smaller than the adjustment mechanism based on MIT, MIT-2SM and MIT-HOSM respectively.

The control signals generated by the PD adaptive with the different adjustment mechanism are presented in the Fig. 7.

**Fig. 7** Control signal of the Adaptive PD controller in altitude (with disturbances)



Then, the control effort of the adaptive mechanism based on MIT-HOSM is 86, 90, and 99% smaller than the generated by the adjustment mechanism based on MIT, MIT-SM, and MIT-HOSM, respectively (see Table 2).

By other hand, the mechanism which presented a bigger error in altitude was the MIT-2SM in altitude, that is, the MIT-2SM is bigger than the adjustment mechanism based on MIT, MIT-SM and MIT-HOSM, that is, 4.23, 14.33 and 0.06%, respectively. Also, the control effort generated by the adjustment mechanism based on MIT-SM is bigger than the presented by the adjustment mechanism based on MIT, MIT-2SM and MIT-HOSM, that is, 28.57, 98.57 and 98.57%, respectively (see Table 2).

In the Fig. 8 is presented the minimization of the cost function with the different adaptive mechanism, and is proved in the figure that  $J(\theta) \rightarrow 0$ . In the Fig. 9 is presented the performance of the adaptive proportional gain  $\hat{k}_p$  and in the Fig. 10 is appreciated the performance of the adaptive derivative gain  $\hat{k}_v$  in altitude movement for the different adaptive mechanism.

The response of the sliding manifold for the adjustment mechanism based on sliding mode theory for the adaptive PD controller in altitude are presented in the Fig. 11 for the adaptive proportional gain and in the Fig. 12 is for the adaptive derivative gain.

**Table 2**  $\mathcal{L}_2$  – norm for the error and the control effort

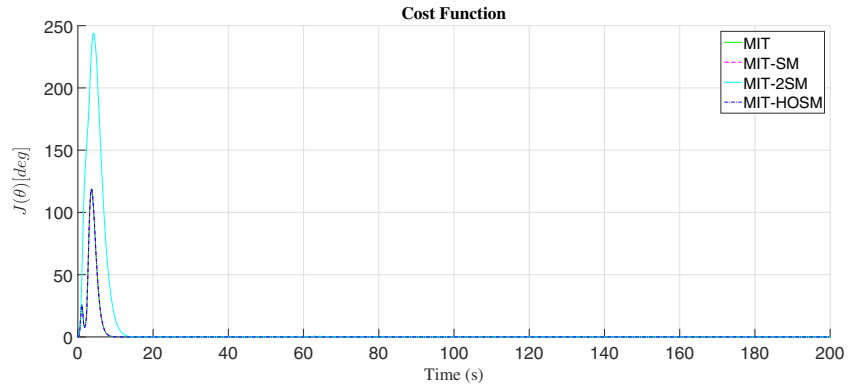
Altitude movement		
Adaptive mechanism	$\mathcal{L}_2[e_{h_m}]$	$\mathcal{L}_2[u_\theta]$
MIT	0.1583	0.0050
MIT-SM	0.1466	0.0070
MIT-2SM	0.1653	$1.7873 \times 10^{-4}$
MIT-HOSM	0.1652	$1.7872 \times 10^{-4}$
Yaw angle		
Adaptive mechanism	$\mathcal{L}_2[e_{\psi_m}]$	$\mathcal{L}_2[u_\psi]$
MIT	0.0760	0.0132
MIT-SM	0.0865	0.0109
MIT-2SM	0.2501	0.0363
MIT-HOSM	1.2323	0.2083
Roll angle		
Adaptive mechanism	$\mathcal{L}_2[e_{\phi_m}]$	$\mathcal{L}_2[u_\phi]$
MIT	0.1964	0.1272
MIT-SM	0.1892	0.1177
MIT-2SM	0.1768	0.3523
MIT-HOSM	0.0780	2.6101

## 4.2 Yaw Movement

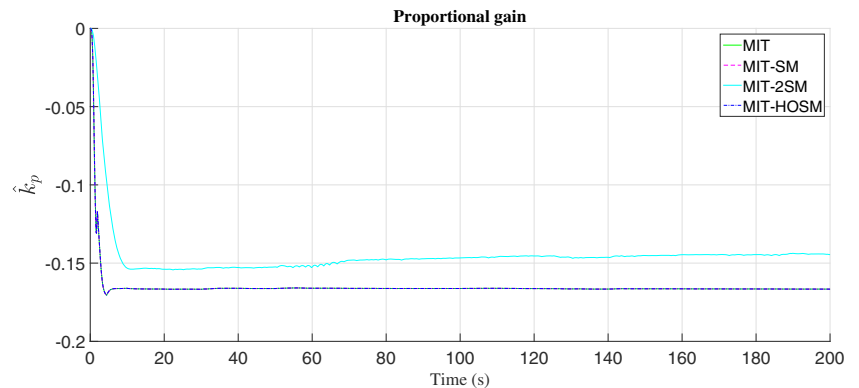
In the Fig. 13 is shown the results obtained with the PD adaptive controller with the different adjustment mechanism. In this figure the objective of control is achieve three different values for the yaw angle, such values are  $5^\circ$ ,  $10^\circ$ , and  $10^\circ$ . The MIT presented an error 12.13, 69.61 and 93.83% smaller than the adjustment mechanism based on MIT-SM, MIT-2SM and MIT-HOSM, respectively. By other hand, the control effort of the adaptive mechanism MIT-SM is 17.42, 69.97 and 94.76% smaller than the adjustment mechanism based on MIT, MIT-2SM and MIT-HOSM, respectively (see Table 2). In the Fig. 14 is presented the control response of the adaptive PD controller with the different adjustment mechanism.

The adjustment mechanism based on MIT-HOSM presented a bigger error in the yaw angle, that is, 93.83, 92.98 and 79.70% than the MIT, MIT-SM and MIT-2SM respectively. Even more, the control effort generated by the PD adaptive control with the adjustment mechanism based on MIT-HOSM is bigger than the adjustment mechanism

**Fig. 8** Minimization of the cost function in altitude (with disturbances)

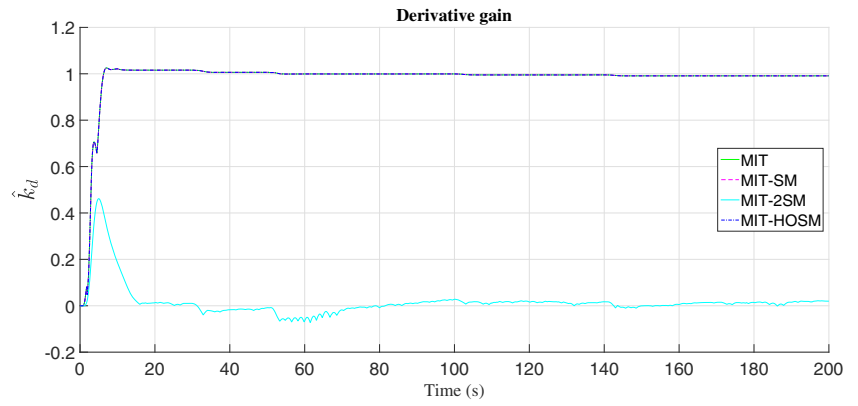


**Fig. 9** Response of the adaptive proportional gain in altitude (with disturbances)

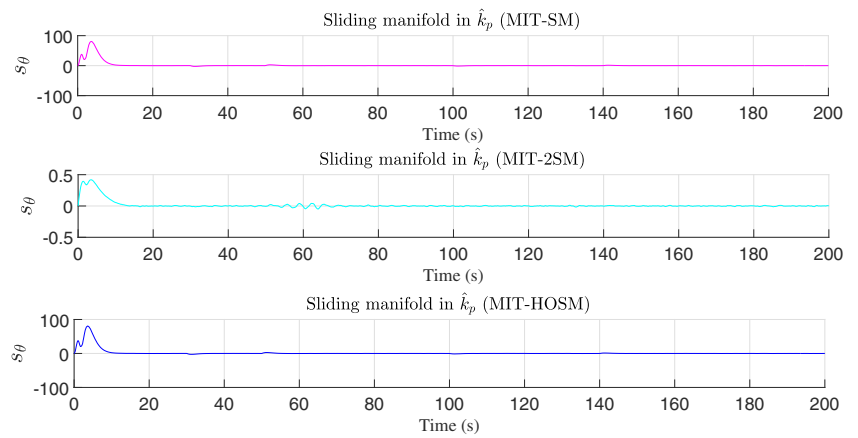




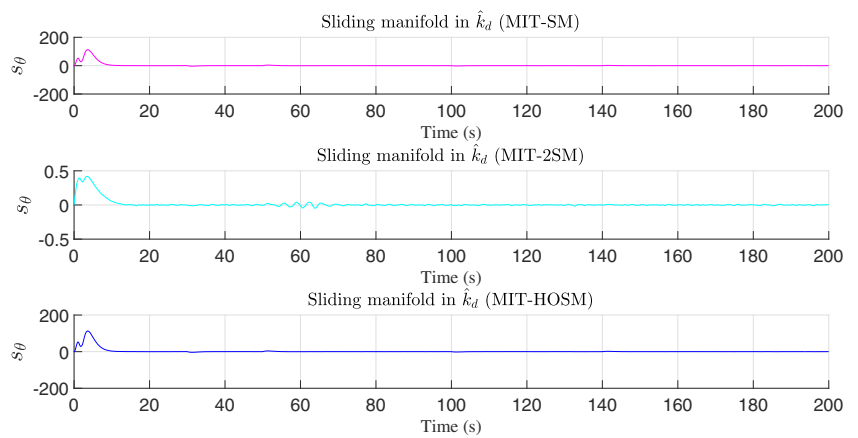
**Fig. 10** Response of the adaptive derivative gain in altitude (with disturbances)



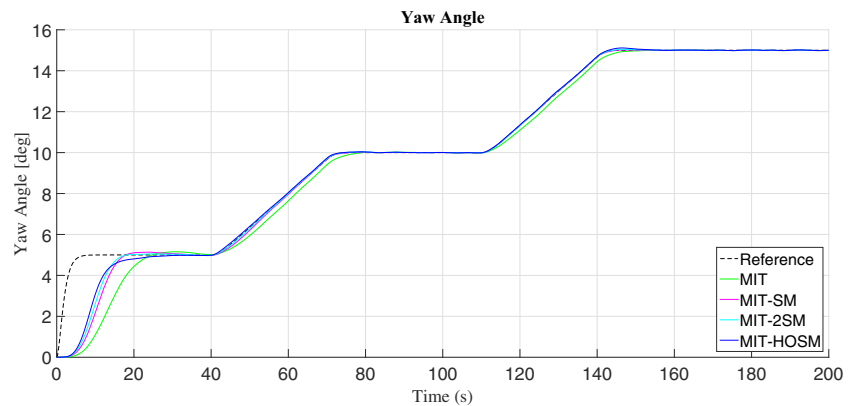
**Fig. 11** Response of the sliding manifold in the adaptive proportional gain in altitude movement (with disturbances)



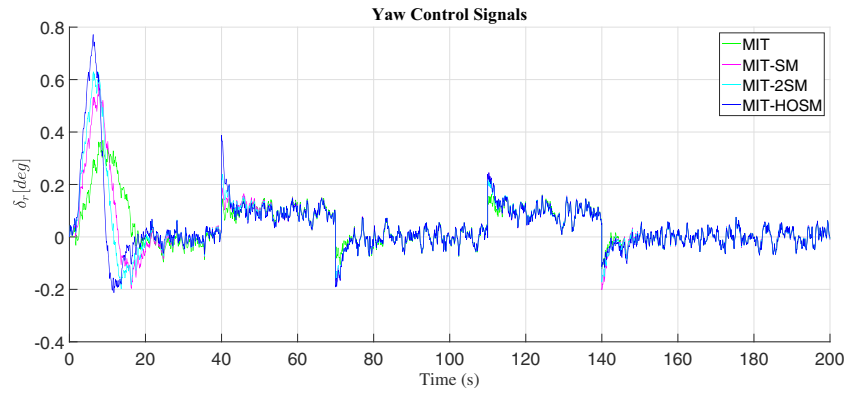
**Fig. 12** Response of the sliding manifold in the adaptive derivative gain in altitude movement (with disturbances)



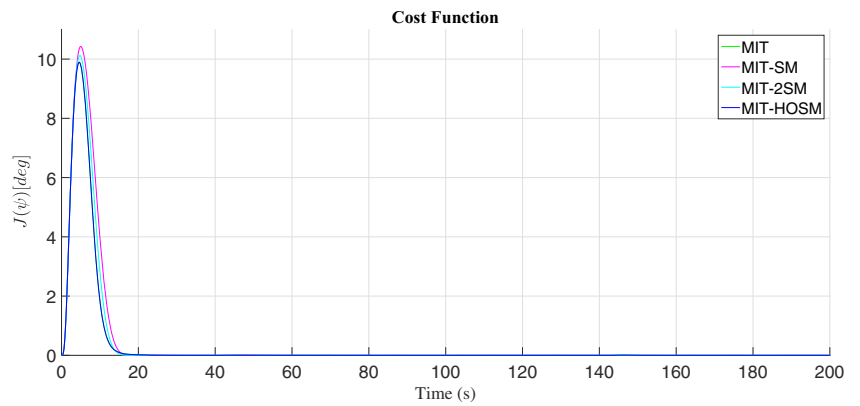
**Fig. 13** Adaptive PD controller response in yaw angle (with disturbances)



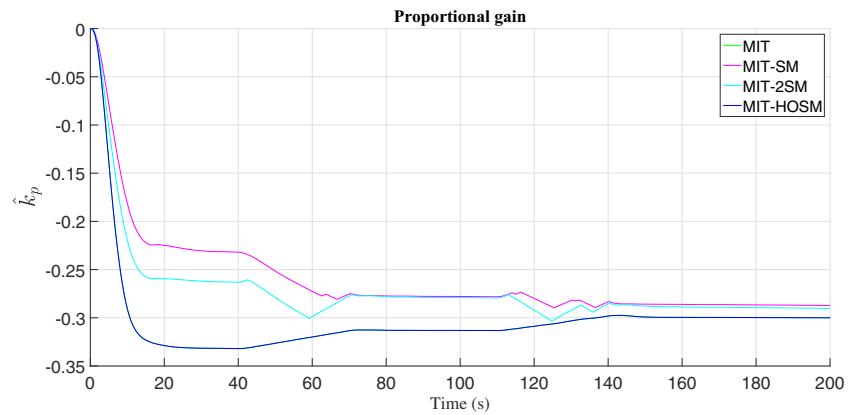
**Fig. 14** Control signal of the Adaptive PD controller in yaw angle (with disturbances)



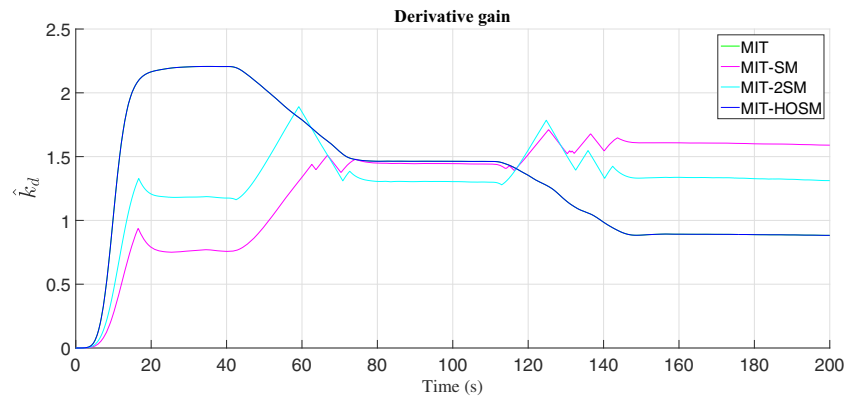
**Fig. 15** Minimization of the cost function in yaw angle (with disturbances)



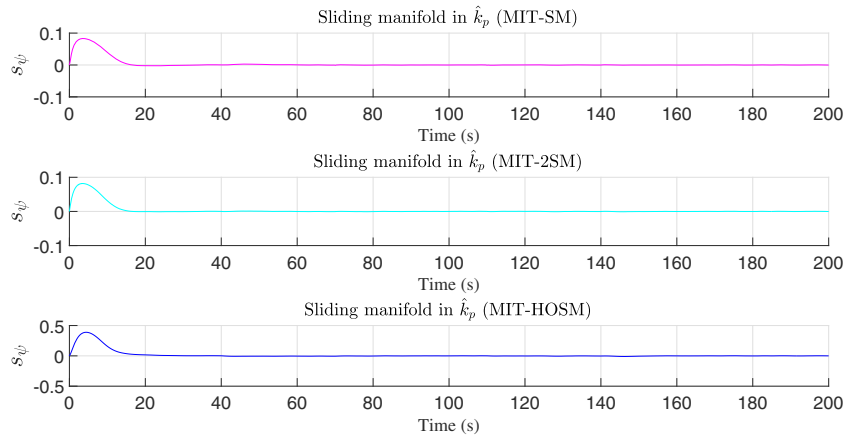
**Fig. 16** Response of the adaptive proportional gain in yaw angle (with disturbances)



**Fig. 17** Response of the adaptive derivative gain in yaw angle (with disturbances)



**Fig. 18** Response of the sliding manifold in the adaptive proportional gain in yaw angle (with disturbances)



based on MIT, MIT-SM, and MIT-2SM, that is, 93.66, 94.76, and 82.57%, respectively, see the Table 2.

In the Fig. 15 is presented the result of the minimization of the cost function for the yaw angle, it is appreciated that  $J(\psi) \rightarrow 0$ . In the Fig. 16 is shown the performance of the adaptive proportional gain  $\hat{k}_p$ , and in the Fig. 17 is appreciated the performance of the adaptive derivative gain  $\hat{k}_v$  in yaw angle for the different adjustment mechanism. The response of the sliding manifold for the adjustment mechanism based on sliding mode theory for the adaptive PD controller in the yaw angle are presented in the Fig. 18 for the adaptive proportional gain and in the Fig. 19 is for the adaptive derivative gain.

### 4.3 Roll Movement

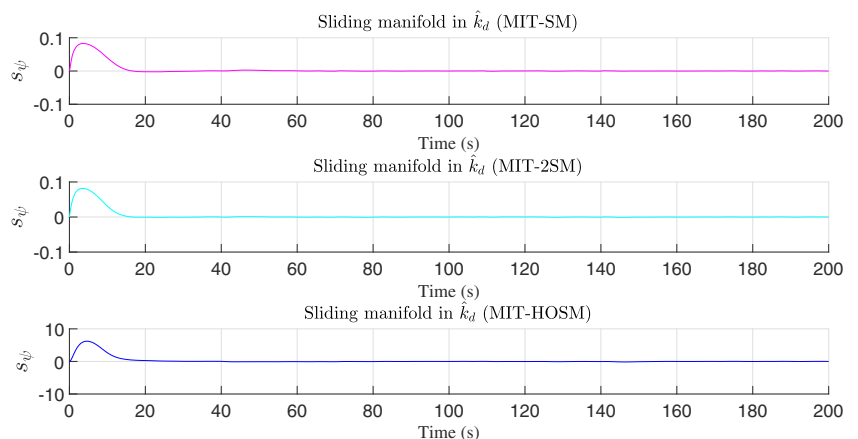
In the Fig. 20, is presented the response of the adaptive PD controller with the different adjustment mechanism. In this figure the references of roll angle to archive by the adaptive PD controller are  $5^\circ$ ,  $25^\circ$ , and  $40^\circ$ . Then, It is appreciated that the error presented by the MIT adjustment mechanism is 16.04, 66.84 and 92.99% smaller than the adjustment mechanism based on MIT-SM, MIT-2SM, and

MIT-HOSM, respectively. Also, the control effort of the adaptive PD controller with the adjustment mechanism based on MIT-SM is 3.17, 67.60 and 94.76% smaller than the adjustment mechanism based on MIT, MIT-2SM and MIT-HOSM respectively, see the Table 2 and Fig. 21.

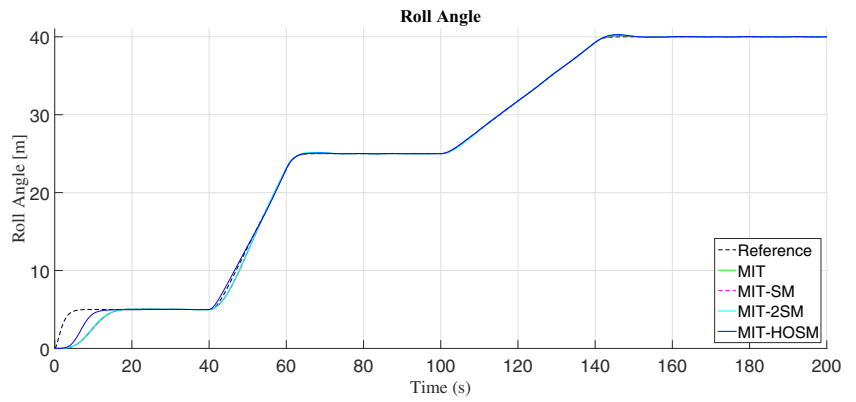
The adjustment mechanism based on the MIT-HOSM rule, the error in roll angle is 92.99, 91.65, and 78.88% bigger than the adjustment mechanism based on MIT, MIT-SM, and MIT-2SM, respectively. Even more, the adjustment mechanism based on the MIT-HOSM, it is 94.59, 94.76, and 83.84 bigger than the adjustment mechanism based on MIT, MIT-SM, and MIT-2SM, respectively (see the Table 2). The minimization of the cost function in the roll angle is presented in the Fig. 22, it is appreciated that  $J(\phi) \rightarrow 0$ . Also, in the Fig. 23 is shown the performance of the adaptive proportional gain  $\hat{k}_p$ , and in the Fig. 24 is appreciated the performance of the adaptive derivative gain  $\hat{k}_v$  in roll angle for the different adjustment mechanism.

The response of the sliding manifold for the adjustment mechanism based on sliding mode theory for the adaptive PD controller in the roll angle are presented in the Fig. 25 for the adaptive proportional gain, and in the Fig. 26 is for the adaptive derivative gain.

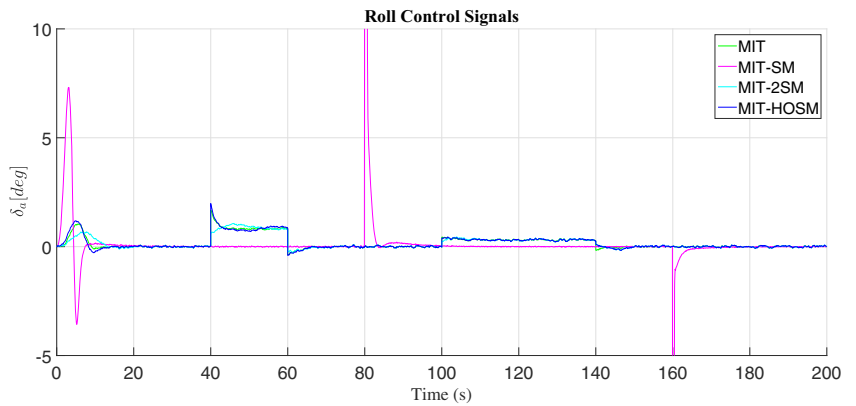
**Fig. 19** Response of the sliding manifold in the adaptive derivative gain in yaw angle movement (with disturbances)



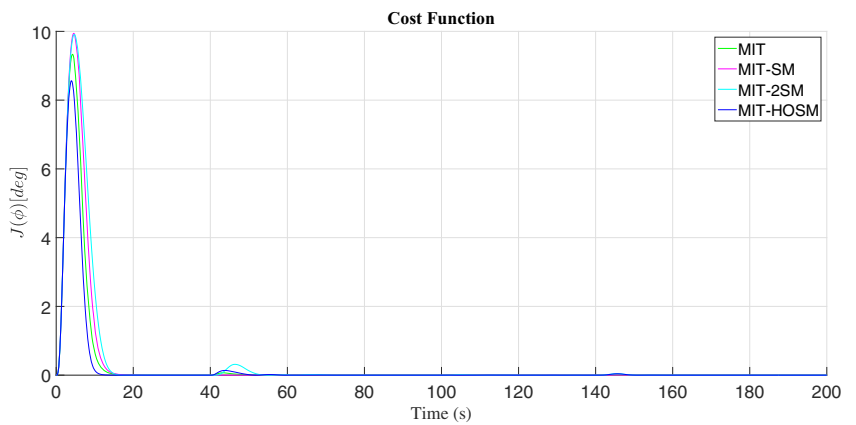
**Fig. 20** Adaptive PD controller response in roll angle (with disturbances)



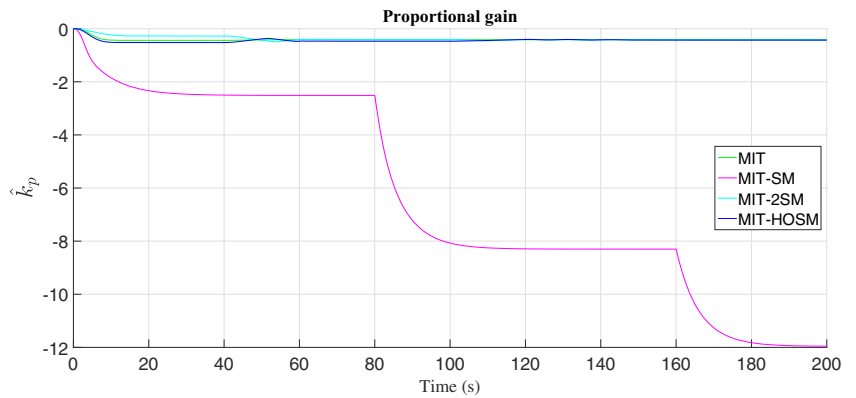
**Fig. 21** Control signal of the Adaptive PD controller in roll angle (with disturbances)



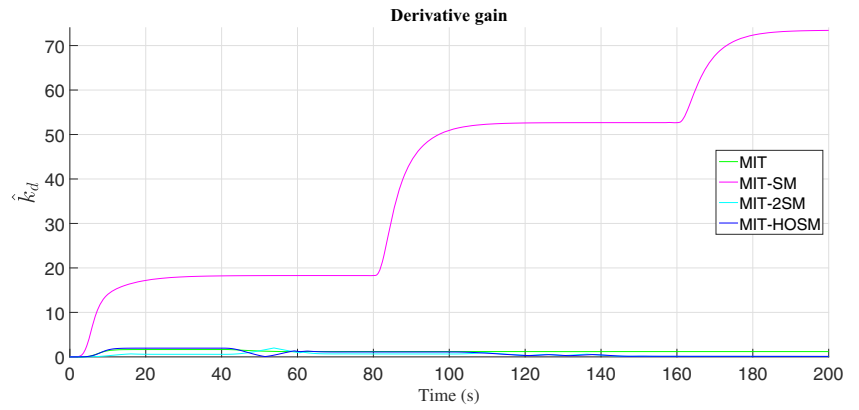
**Fig. 22** Minimization of the cost function in roll angle (with disturbances)



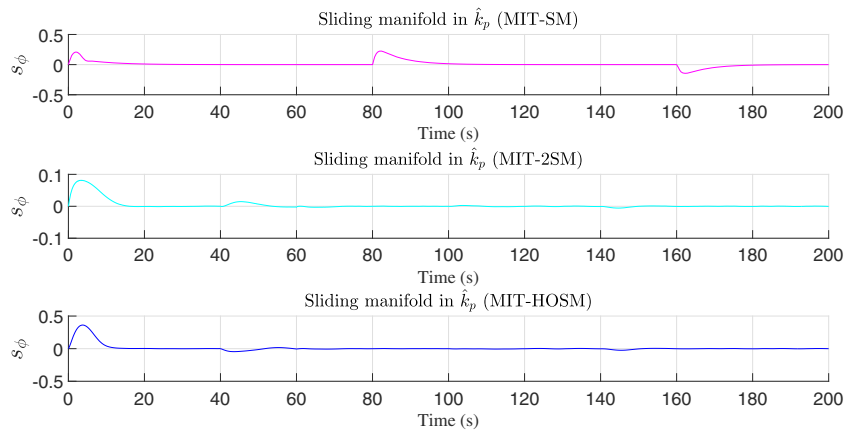
**Fig. 23** Response of the adaptive proportional gain in roll angle (with disturbances)



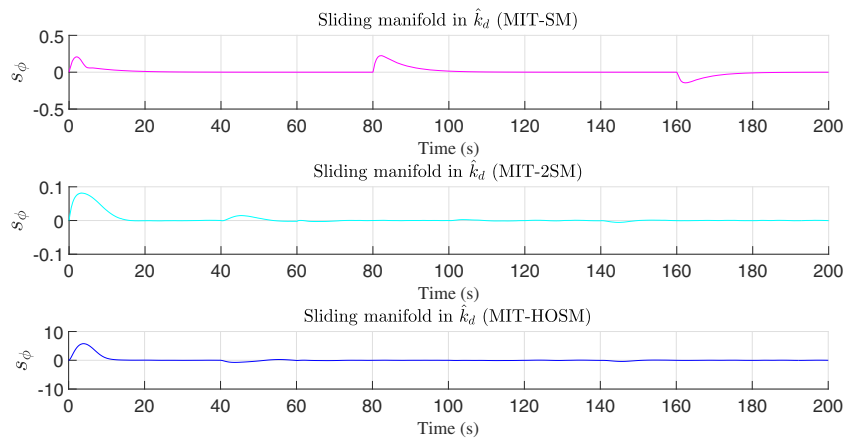
**Fig. 24** Response of the adaptive derivative gain in roll angle (with disturbances)



**Fig. 25** Response of the sliding manifold in the adaptive proportional gain in roll angle (with disturbances)



**Fig. 26** Response of the sliding manifold in the adaptive derivative gain in roll angle movement (with disturbances)



## 5 Conclusions

In this work has been proposed an adjustment mechanism based on the union of the MIT rule using the gradient method with the sliding mode theory, this adjustment mechanism was development to obtain an adaptive PD controller. Thus, with the adjustment mechanism based on the MIT rule with high order sliding mode (MIT-HOSM) was possible reduce the chattering effect and even the unknown perturbation is reduced significantly in the altitude movement and in the roll angle. Also, for yaw angle was possible some reduction in the chattering effect by the use of the MIT rule with high order sliding mode (MIT-HOSM). Then, with the use of the adjustment mechanism based on in the MIT rule with the gradient method is not possible reduced the unknown perturbation and in consequence is not possible achieve an stable or equilibrate flight. The adjustment mechanism based on the MIT rule with first order sliding mode (MIT-SM) presented the undesired chattering effect, but with the MIT with second order sliding mode (MIT-2SM) was possible attenuate in a better way in the altitude movement. By other hand, for the yaw and roll angles exist some reduction but not enough to reduce the chattering and the unknown perturbation with the MIT with second order sliding mode (MIT-2SM). Thus, designing an adjustment mechanism based on the union of the MIT rule by the gradient method with the high order sliding mode is possible design a robust adjustment mechanism for a adaptive PD controller in order to attenuate the chattering effect and reduce the perturbations (wind gusts) which affect the performance of a fixed-wing miniature unmanned aerial vehicle.

**Acknowledgements** This work was partially supported by funds of the Faculty of Engineering, Science and Architecture UJED, and the TecNM projects.

## References

1. Slotine, J.J., Li, W.: Applied Nonlinear Control. Prentice Hall, Englewood Cliffs (1991). ISBN: 0-1304-0890-5 USA
2. Cook, M.V.: Flight Dynamics Principles, 2nd edn. Elsevier, Great Britain (2007). ISBN: 978-0-7506-6927-6
3. Åström K.J., Wittenmark, B.: Adaptive Control, 2nd edn. Prentice Hall, Englewood Cliffs (1994). ISBN: 978-0201558661
4. Jain, P., Nigam, M.J.: Design of a model reference adaptive controller using modified MIT rule for a second order system. Adv. Electr. Electron. Eng. Ser. **3**(4), 477–484 (2013). ISSN 2231-1297
5. George, A., Francis, R.M.: Model reference control of binary distillation column composition using MIT adaptive mechanism.

- International Journal of Engineering Research & Technology (IJERT) **4**(06), 555–558 (2015). ISSN 2278-0181
6. Kumer, S., Manic, K.S., Deepa, P.: Model reference adaptive control of a spherical tank. Aust. J. Basic Appl. Sci. **8**(18), 350–355 (2014)
  7. Hakan, K., Demet, C., Yasemin, I.: A model reference adaptive controller performance of an aircraft roll attitude control system. In: Recent Advances on Systems, Signals, Control, Communications and Computers, Budapest, Hungary, December 12–14 (2015)
  8. Ghaffar, A., Richardson, T.: Model reference adaptive control and LQR control for quadrotor with parametric uncertainties, world academy of science. Engineering and Technology International Journal of Mechanical, Aerospace, Industrial, Mechatronic and Manufacturing Engineering **9**(2), 244–250 (2015)
  9. Zhou, W., Yin, K., Wang, R., Wang, Y.: Design of attitude control system for UAV based on feedback linearization and adaptive control. Math. Probl. Eng. **2014**, 8 (2014). Hindawi Publishing Corporation
  10. Brian, L.S., Frank, L.: Aircraft Control and Simulation, 2nd edn. Wiley, New York (1992). ISBN: 0-471-61397-5
  11. Mclean, D.: Automatic Flight Control Systems. Prentice Hall International, Englewood Cliffs (1990). ISBN: 0-13-054008-0
  12. Espinoza Fraire, A.T., Parada Morado, R.P., Dzul López, A.E., Lozano Leal, R.: Design and implementation of fixed-wing MAV controllers. In: Third RED-UAS 2015 Workshop on Research, Education and Development of Unmanned Aerial Systems November 23–25, 2015, Cancún, México (2015)
  13. Parada, R.P., Espinoza, A.T., Dzul, A.E., Salas, F.G.: Performance analysis of nonlinear observers applied to the fixed-wing unmanned aerial vehicles flight under decoupled-reduced model. International Journal of Micro Air Vehicles **9**(2), 1–13 (2017)
  14. Espinoza-Fraire, T., Dzul, A., Cortes-Martinez, F., Giernacki, W.: Real-time implementation and flight tests using linear and nonlinear controllers for a fixed-wing miniature aerial vehicle (MAV). Int. J. Control. Autom. Syst. **16**(1), 392–396 (2018)
  15. Levant, A.: Robust exact differentiation via sliding mode technique. Automatica **34**, 379–384 (1998)

**A. T. Espinoza-Fraire** received the BSc degree in electronic engineering from the Superior Technological Institute of Lerdo, Cd. Lerdo Durango Mexico, in 2007, and the MSc and the PhD in electrical engineering from the Technological Institute of La Laguna, Torreon Coahuila Mexico, in 2011 and 2015 respectively. Since January 2017 is working as a research professor in the Faculty of Engineering, Science and Architecture, at Universidad Juárez del Estado de Durango. His research interests are in linear and nonlinear control theory, navigation and control of UAVs and embedded systems.

**YangQuan Chen** received his Ph.D. degree in advanced control and instrumentation from Nanyang Technological University, Singapore, in 1998. Dr. Chen was on the Faculty of Electrical and Computer Engineering at Utah State University before he joined the School of Engineering, University of California, Merced in 2012 where he teaches mechatronics for juniors and fractional order mechanics for graduates. His research interests include mechatronics for sustainability, cognitive process control and hybrid lighting control, multi-UAV based cooperative multi-spectral personal remote sensing and applications, applied fractional calculus in controls, signal processing and energy informatics; distributed measurement and distributed control of distributed parameter systems using mobile actuator and sensor networks.

**A. Dzul** was born in Gómez Palacio, México, on April 30, 1971. He received the B.S. degree in electronic engineering and the M.S. degree in electrical engineering, both from Instituto Tecnológico de La Laguna, México, in 1993 and 1997, respectively, and the Ph.D. degree in automatic control from Université de Technologie de Compiègne, France, in 2002. Dr. Dzul has been a research professor with the Electrical and Electronic Engineering Department at Instituto Tecnológico de La Laguna since 2003. His current research interests are in the areas of nonlinear dynamics and control, and real-time control with applications to aerial vehicles.

**R. Lozano** received the master of science degree in electrical engineering from Centro de Investigación y de Estudios Avanzados (CINVESTAV), Mexico City, Mexico, in 1977, and the Ph.D. degree in automatic control from the Laboratoire d'Automatique de Grenoble, Grenoble, France, in 1981. From 1981 to 1989, he was with the Department of Electrical Engineering, CINVESTAV. He was the Head of the Section of Automatic Control from 1985 to 1987. He has held visiting positions at the University of Newcastle, Callaghan, NSW, Australia, from 1983 to 1984, the NASA Langley Research Center, Hampton, VA, USA, from 1987 to 1988, and the Laboratoire d'Automatique de Grenoble, from 1989 to 1990. Since 1990, he has been the CNRS Research Director with the University of Technology of Compiègne, Compiègne, France, where he was the Head of the Laboratory Heudiasyc UMR 6599 CNRS-UTC, Compiègne, France, from 1995 to 2007. His current research interests include adaptive control of linear, nonlinear systems, robot manipulators, passive systems, teleoperation, unmanned aerial vehicles, and autonomous underwater vehicles. Dr. Lozano was an Associate Editor of the *Automatica* from 1987 to 2000 and he has been an Associate Editor of the *International Journal of Adaptive Control and Signal Processing* since 1993.

**R. Juarez**, works as university professor in the Facultad de Contaduría y Administración, FCA, Torreon Coahuila campus, of the Universidad Autónoma de Coahuila, UAdeC. He obtained his diploma on Physics and Mathematics in the Escuela Superior de Física and Matemáticas (ESFM) in the Instituto Politécnico Nacional (IPN). He obtained the Master's and Ph degree both in sciences with speciality in Control Theory in the Centro de Investigación y de Estudios Avanzados del Instituto Politécnico Nacional (CINVESTAV-IPN) in Mexico city. He has written some scientific publications on scientific journals and conferences. His research is directed to the investigation of mathematical models supported by ICTs to generate business development and management; the management of knowledge and transmission of technology to vulnerable groups supported in the innovation; the generation and transfer of scientific and technological innovation supported on sustainability; optimal control, non-linear control, robust control, hybrid systems, switched, implicit and with delays, applied in the area of economy, administration and finance; game theory, intelligent control, stochastic control and control of unmanned aerial vehicles (UAV); the development of computational algorithms for the modeling, optimization and control of economic and financial systems: Econometrics; and the modeling of physical systems and economic.