



HAL
open science

Dynamic supramolecular polymers built from cucurbit[n]urils and viologens

Henrique Dias Correia, Shagor Chowdhury, Ana Paula Ramos, Laure Guy,
Grégoire Jean-François Demets, Christophe Bucher

► **To cite this version:**

Henrique Dias Correia, Shagor Chowdhury, Ana Paula Ramos, Laure Guy, Grégoire Jean-François Demets, et al.. Dynamic supramolecular polymers built from cucurbit[n]urils and viologens. *Polymer international*, In press, 68 (4), pp.572-588. 10.1002/pi.5709 . hal-01927354v1

HAL Id: hal-01927354

<https://hal.science/hal-01927354v1>

Submitted on 19 Nov 2018 (v1), last revised 4 Jan 2021 (v2)

HAL is a multi-disciplinary open access archive for the deposit and dissemination of scientific research documents, whether they are published or not. The documents may come from teaching and research institutions in France or abroad, or from public or private research centers.

L'archive ouverte pluridisciplinaire **HAL**, est destinée au dépôt et à la diffusion de documents scientifiques de niveau recherche, publiés ou non, émanant des établissements d'enseignement et de recherche français ou étrangers, des laboratoires publics ou privés.

Dynamic Supramolecular Polymers Built From Cucurbit[n]urils And Viologens

Henrique Dias Correia^{€,‡}, Shagor Chowdhury[§], Ana Paula Ramos[‡], Laure Guy[§], Grégoire Jean-François Demets^{‡*}, Christophe Bucher^{§*}

[§]*Univ Lyon, Ens de Lyon, CNRS UMR 5182, Université Claude Bernard Lyon 1, Laboratoire de Chimie, F69342, Lyon, France. Christophe.bucher@ens-lyon.fr*

[€]*Escola Técnica ETEC Ângelo Cavalheiro, Rua José Correia Filho 750 CEP 140150-000 Serrana SP Brazil*

[‡]*DQ-FFCLRP, Universidade de São Paulo. Av. Bandeirantes 3900, CEP 14040-901, Ribeirão Preto S.P. Brazil. (55) 16 3315 4860 greg@usp.br*

Abstract

This review article focuses on supramolecular assemblies involving cucurbit[n]uril-based containers and viologen guests as key building elements. Cucurbit[n]urils (CB[n], n=5-10) are fascinating hosts forming a wide range of inclusion complexes (caviplexes) with 4,4'-bipyridinium salts, known as viologens, either as discrete 1:1 inclusion compounds with CB[7] or as ternary inclusion compounds involving two hosts or two guests (2:1) with CB[7], and (1:2 or 1:1:1) with CB[8]. This property is currently being actively exploited to design and prepare self-assembled dynamic stimuli-responsive supramolecular polymers including gels, vesicles, films and organized arrays of polymeric microspheres or nanoparticles. This reviews highlights the main benefits of such polymers and gives an overview of the achievements and progresses made in this field over the past decades .

Keywords : Viologens, cucurbit[n]urils, polymers, self-assembly, films, gels, nanoparticles

1. Introduction	2
2. Soluble supramolecular assemblies	3
a. Basics of viologens insertion in cucurbiturils	3
b. Rotaxane-like polymers	5
c. Stimuli-responsive supramolecular assemblies.	8
3. Towards dynamic supramolecular materials	14
d. Vesicles	14
e. Hydrogels.	16
f. Films, superlattices and nanoparticles	21
4. Conclusion	26
5. References	27

1. Introduction

Supramolecular assemblies are ubiquitous in living systems. The best known example is most probably DNA, wherein simple molecular building blocks are organized into functional structures *via* a complex network of orthogonal¹ non covalent bonds.² In more general terms, biologically relevant supramolecules have been an endless and exciting source of inspiration for designing self-assembled supramolecular polymers with tailored structural, dynamic and functional features. Fortunately enough, the supramolecular toolbox available to address these challenging issues contains a wide variety of noncovalent interactions, varying in directionality and strength, from weak dipole–dipole attractive forces to highly directional hydrogen bonds and strong electrostatic ion–ion and ion-dipole interactions. The unique properties and the main advantages of supramolecular polymers as compared to classical covalent polymers rely on the reversible and dynamic nature of the interactions involved in their construction. This key feature has *inter alia* opened up exciting opportunities for the development of stimuli-responsive, self-healing or self-adjusting materials. All these aspects have already been covered in many excellent review articles, to which the reader is referred for further information, focusing either on the preparation or on the properties of supramolecular polymers.³⁻⁷

The scope of this review is to point out the strategies which have been implemented to promote the formation of self-assembled supramolecular polymers from cucurbit[n]uril (CB[n]) hosts and viologen guests, used as key building elements. The first part focuses on the inclusion of viologens in CB[n] and provides an overview of the polymeric systems

reported in literature involving these two components. The second part is dedicated to the applications of these specific host-guest processes in “soft-material” science, most notably to provide access to vesicles, hydrogels and hybrid nanoparticle-containing systems.

2. Soluble supramolecular assemblies

a. Basics of viologens insertion in cucurbiturils

1,1-Di(hydrocarbyl)-4,4'-bipyridinium salts, best known as Viologens (V^{2+}),⁸ exhibit unique redox and chemical behaviors which have proved highly valuable to the construction of functional molecular materials,⁹ including for applications in organic electronics, organic batteries and for the development of molecular machines. Viologen derivatives are for instance commonly used as electron poor components in donor-acceptor type host-guest complexes, as seen in Stoddart's works on “blue-box”-based rotaxane and catenanes.¹⁰⁻¹² From an electrochemical point of view, these dicationic compounds are subject to two consecutive Nernstian electron transfers¹³ attributed to the successive formation of the cation-radical $V^{\bullet+}$, and neutral quinonic forms V^0 . The growing interest for viologen derivatives in supramolecular chemistry over the past decades thus mainly stems from the acceptor properties of the dicationic V^{2+} « ground » state and from the stability of the radical-cation state¹⁴ $V^{\bullet+}$ which can both be implemented¹⁴ for the construction of supramolecular assemblies.^{10-12, 15, 16}

Cucurbit[n]urils (CB[n]s) represent a specific class of barrel-shaped cavitands made of n glycoluril moieties connected by methylene bridges.^{17, 18} They are compatible in size with cyclodextrins, and the nature of their cavity (in terms of solvophobicity) are similar, but CB[n]s are more stable towards temperature and aggressive chemical environments. CB[n]s are also not toxic, cheap and resistant to microorganisms, which makes them excellent candidates to replace cyclodextrins for most applications. Our own contribution to this field include the stabilization of reactive species and drug carriers,¹⁹⁻²² use of CB[n] as structural elements in hybrid composites,^{23, 24} as template for nanoparticle synthesis,^{25, 26} or to develop special catalysts and coatings,^{27, 28} sensors²⁹ and speciality polymers.²³ Their ability to host a wide range of substrates is mainly due to the hydrophobicity of the inner cavity lacking hydrogen bond donors/acceptors moieties. From a thermodynamic point of view, the exceptionally high affinity of CB[n]s for positively charged organic guests in water is attributed to a combination of factors including the desolvation of the guest, the ejection of « high energy » water molecules trapped inside CB[n]s prior to encapsulation, and to ion-

dipole interactions between the carbonyl functions at the cavity portal and any positively charged parts of the guest. In most cases only one guest can be fitted within the cavity of the smallest CB[n] (n=5,6,7) while the larger cavity of CB[8] can potentially accommodate two or even three guests.³⁰⁻³⁵

As a matter of fact, most efforts in the field of supramolecular chemistry have focused on CB[8], on account of its ability to accommodate two π -conjugated guests tightly interacting inside the barrel-shaped cavity in the form of cofacial charge transfer complexes.³⁶ The opportunities are conversely more limited for the smallest analogs CB[5], CB[6] and CB[7], whose inner cavities only allow to host single guests. Another key aspect of CB[n]s is their exceptionally strong affinities for a wide range of cationic or even neutral guests in aqueous media, with binding constants among the largest ever reported for host-guest complexes, reaching 10^{17} M^{-1} for CB[7] and diamantane.³⁷ The most common Host-Guest (HG) complexes formed with CB[n] and viologens are shown in Figure 1. The size, structure and symmetry of viologen derivatives, together with their dicationic nature, make them perfect guests for CB[7 or 8], forming very stable caviplexes (Figure 1a) with binding constants as high as $5 \times 10^4 \text{ M}^{-1}$ with CB[7] and $1.1 \times 10^5 \text{ M}^{-1}$ with CB[8] in water at 25 °C.^{38,39} The major driving force for the formation of such caviplexes seems to be strong ion-dipole interactions between the cavitands *oculi* and the positive charges of the guest. CB[8] can even accommodate two viologen cation radicals to yield the dicationic 1:2 caviplex depicted in Figure 1b, wherein charge repulsion is lowered by the one-electron reduction of each viologens. This homo-valent complex involving extensive orbital overlaps between two viologen cation radicals is known as a π -dimer.^{16, 40-43} Then, ternary hetero-caviplexes(1:1:1) are also frequently observed with CB[8]; the latter case being illustrated in Figure 1c with a CB[8]-stabilized charge transfer complex between a dimethylated viologen and an electron-rich dihydroxynaphthalene.⁴⁴

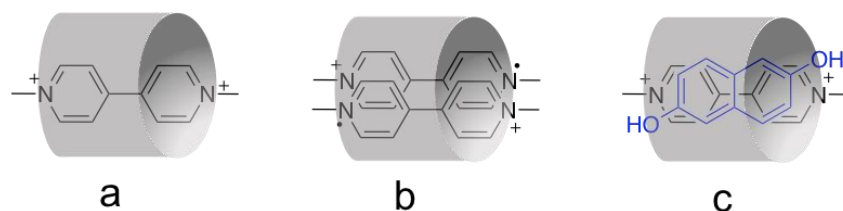

Figure 1: Selected examples of CB[7,8] methyl-viologen caviplexes: a) $MV^{2+}@CB[7]$; b) $(MV^+)_2@CB[8]$; c) $MV^{2+}.DHN@CB[8]$.

b. Rotaxane-like polymers

Many examples of pseudo-rotaxane-like oligomers and polymers incorporating a rod-like guest and cyclic ring-like hosts held together by noncovalent forces are found in literature.⁴⁵ The prefix *pseudo* used here, refers to the absence of stoppers on both ends of the molecular axle, which implies that the CB[n] wheels are free to move out. Such pseudo-rotaxanes have been obtained by self-assembly of different viologens-based polymers/oligomers with CB[n]. The main strategies investigated so far involve either CB[6], CB[7] or CB[8] wheels threaded on linear viologen-based oligomer/polymer strings (Figure 2a),^{46, 47} on dendrimers⁴⁸ or on branched polymers (Figure 2b).^{49, 50}

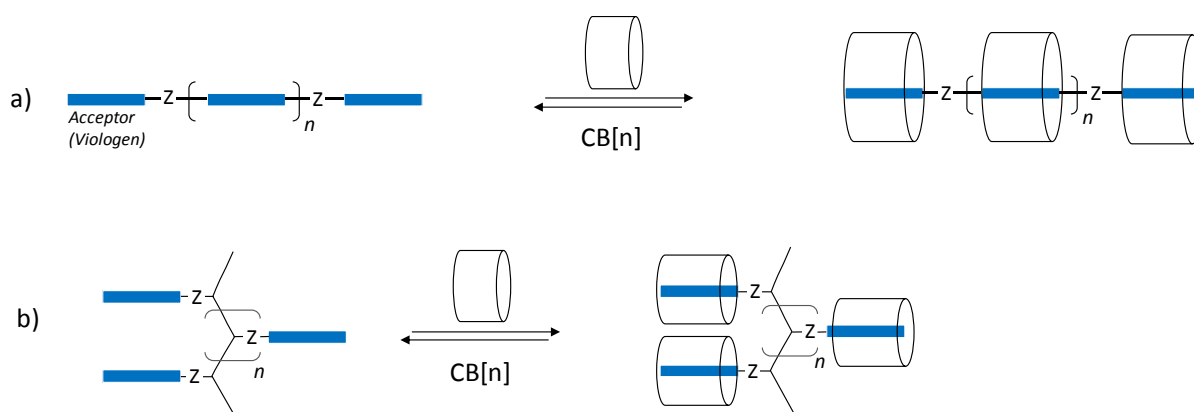

Figure 2. Threading CB[n]s on linear or on branched polymer backbones.

With CB[8], the large size of the inner cavity enables to stabilize a wide range of π -conjugated donor-acceptor pairs. This specific feature has been exploited to develop different elongation approach sketched in Figure 3, aiming at extending the length of polymer backbones. The most straightforward strategy relies on a CB[8]-promoted self-association of two identical or two different polymers bearing either a π -acceptor (viologen-based) or a π -donor (naphthalene-based) pendant guest (Figure 3a). Formation of a host-stabilized charge-transfer complex between those two units opens the way towards either homo- ($P1=P2$) or hetero-extended polymers ($P1 \neq P2$).⁵¹ A similar strategy has been implemented to provide access to a supramolecular protein/polymer conjugate involving bovine serum albumin and a poly(ethylene glycol)-based polymer.⁵² The name of «supramolecular handcuff» has been put forward to describe such system that ties together two different (macro)molecular units with reversible and non-covalent bonds.⁵²

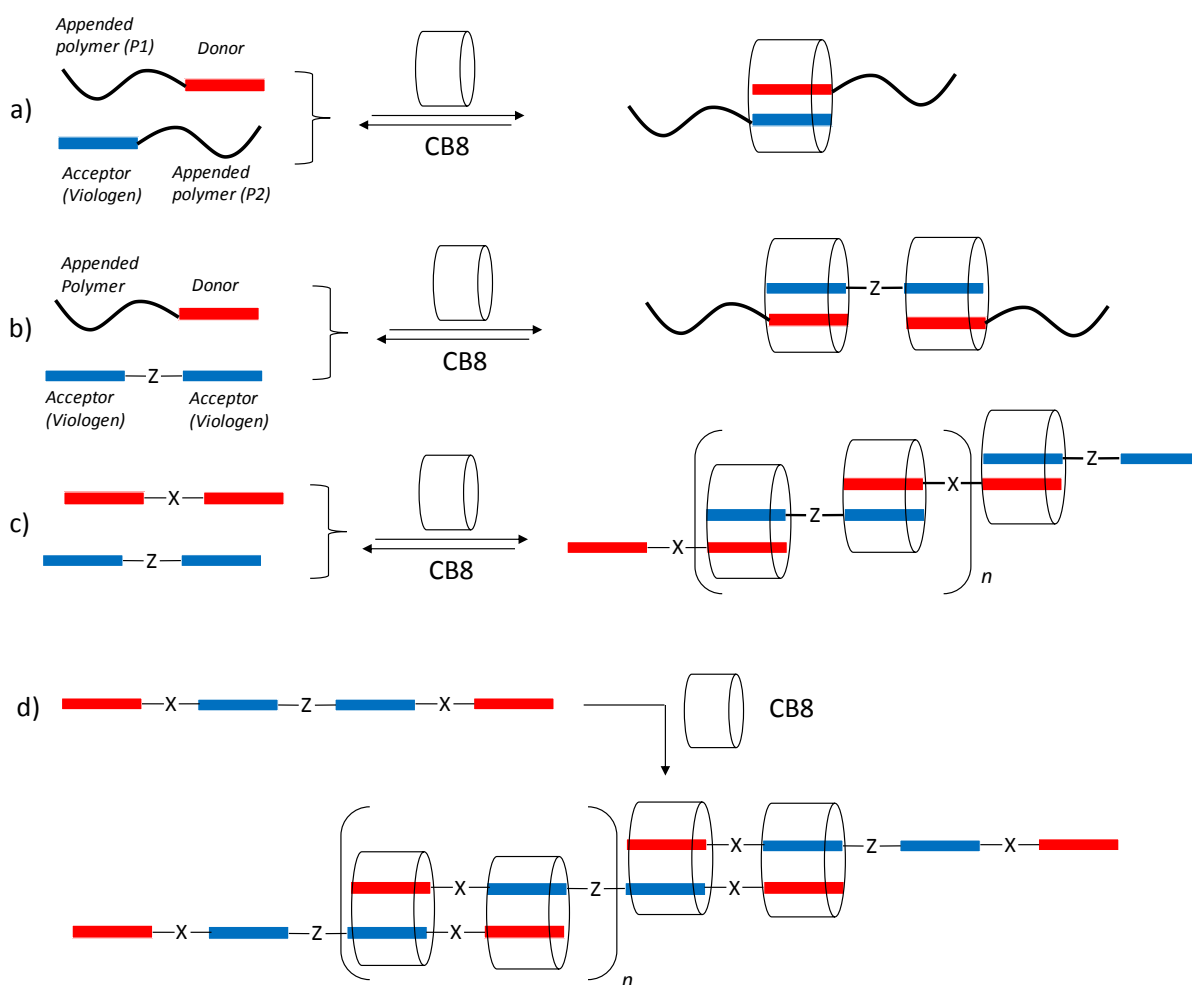

Figure 3. Schematic representation of the threading and elongation strategies developed with viologen-based polymers.

A variation of this method has been developed to link two identical donor-terminated polymers with a bis-viologen spacer (Figure 3b). In the presence of CB[8], a naphthol-terminated PEG chain (Donor block) and a low molecular weight bis-viologen guest (Acceptor block) were found to form discrete supramolecular DAD triblock copolymers.⁵³ The authors have also shown that DOSY NMR and solution viscometry can advantageously be used to probe the self-assembly process in aqueous media.⁵⁴

The first report on a host-stabilized self-assembled “charge-transfer” polymer built from DAAD-type monomers and CB[8] (Figure 3d) has been published in 2010 by the group of Zhang.⁵⁵ Polymerization of the anthracene terminated building block **13** (Figure 6) was mainly established on the ground of AFM-based single-molecule force spectroscopy, DLS and ¹H NMR experiments. Self-assembly of **13** in aqueous media was moreover found to promote the formation of hydro-gel materials. A similar approach has been developed with an

azobenzene -containing DAAD monomer (azobenzene–viologen–viologen–azobenzene, compound **12** in Figure 6).⁵⁶ The molecular weight and the polydispersity of the supramolecular polymers grown by iterative complexation of the viologen/azobenzene/CB[8]units has here been shown to depend on the relative molar ratio of the monomers involved in the self-assembled architecture and on the *Z* vs *E* geometry of the azobenzene photoisomerizable moieties.⁵⁶

A supramolecular « bottlebrush » polymer has been constructed similarly from rigid AA and DD type monomers in water (Figure 3c and Figure 4). The self-assembled supramolecular polymer formed in the presence of CB[8] has been mainly characterized by DLS and DOSY NMR.⁵⁷

Following a similar strategy, the three-component self-assembly of rigid porphyrin-based cross-shaped vertexes (AAAA tectons) with flexible oligoethylene glycol edges (DD tectons) and cucurbit[8]uril was found to provide access to 2D polymers whose internal pore sizes could be potentially determined by the length of the PEG chain in the DD tecton (Figure 5).⁵⁸ The morphology of the self-assembled structures was mainly characterized by SEM, TEM, AFM and small angle X-ray scattering. The 2D materials exhibit pliable features resulting from flexible nature of the oligoethylene glycol edges

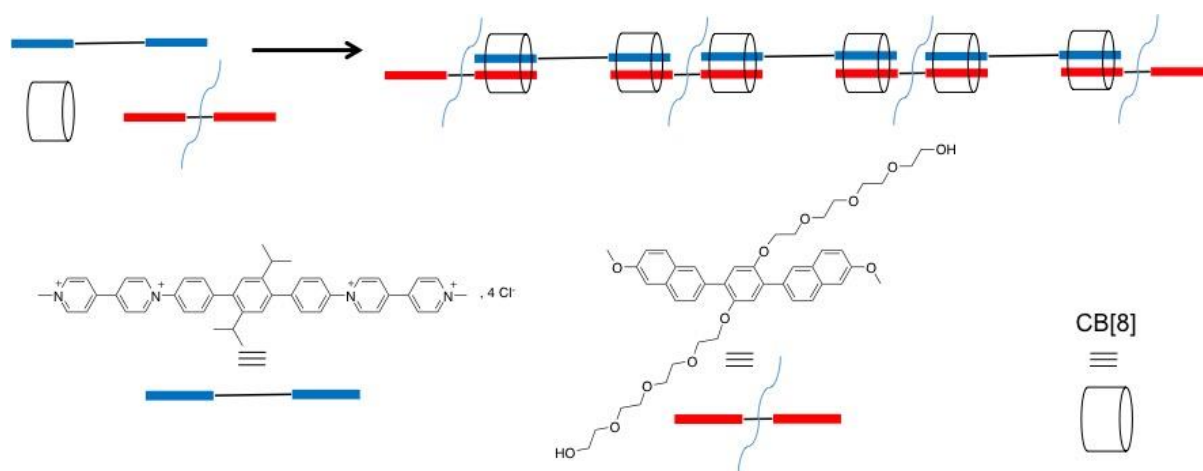

Figure 4: Supramolecular « bottlebrush » polymer constructed from rigid AA and DD type monomers.⁵⁷

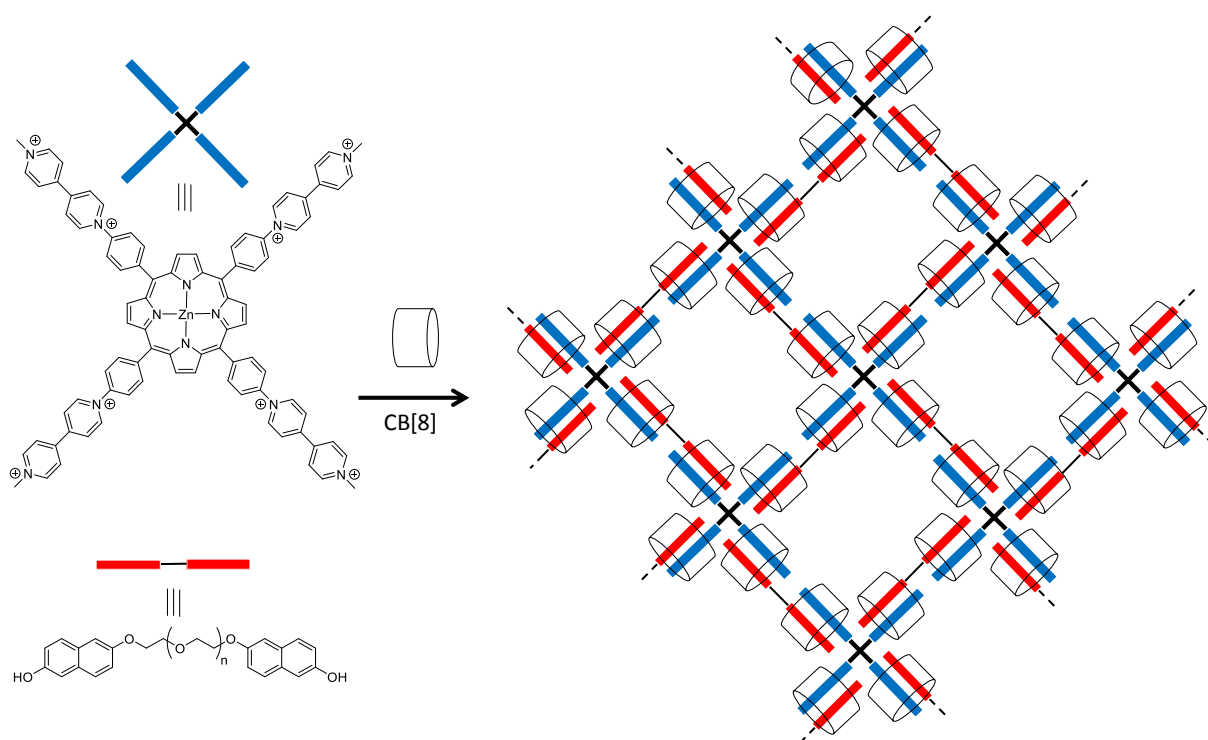

Figure 5. Schematic representation of a 2D supramolecularly polymeric pattern obtained from porphyrin-based AAAA and hydroxy naphthalene-based DD monomers.⁵⁸

c. Stimuli-responsive supramolecular assemblies.

The ability to control the organization of molecules within molecular materials has emerged in the past decade as a major scientific objective that is mainly motivated by exciting foreseeable applications in areas ranging from electronics to medicine. Enormous technological interests are indeed at stake in being able to control and exploit the properties of dynamic self-assembled materials built from monomers and held together by reversible and directional interactions.

The arrangement/organization within supramolecular assemblies built from viologens and CBs can potentially be modulated with chemical, photochemical and electrochemical stimuli.⁵⁹ The redox properties of viologens and the ability of CB[8] host to promote the π -dimerization of viologen cation radicals^{10, 12, 60-63, 64, 65-67} are particularly suited to this purpose. π -dimers is the commonly accepted trivial denominations designating sandwich-like, multicenter-bonded, dimeric entities featuring sub Van der Waals (VdW) intra-dimer separation distances. In π -dimers, the non-covalent “chemical bonding” arises from the orbital overlaps occurring between two identical cation radicals. Another salient feature of π -dimers is their metastable character inherent to the weakly stabilizing bonding term that is hardly

sufficient to counterbalance the Coulombic repulsion arising between both positive charges. As a matter of fact, the vast majority of π -dimers reported so far in literature involves intermolecular overlaps imposed either at the solid state by packing effects or favored in solution by the use of unusually high concentrations of radicals. To cope with this problem, one strategy which has proved quite effective in promoting the formation of non covalent long-bonded dimers in standard temperature and concentration ranges, relies on the use of container molecules, such as the cyclodextrins or cucurbit[n]urils, capable of hosting and stabilizing such self-assembled dimeric entities.^{68, 69}

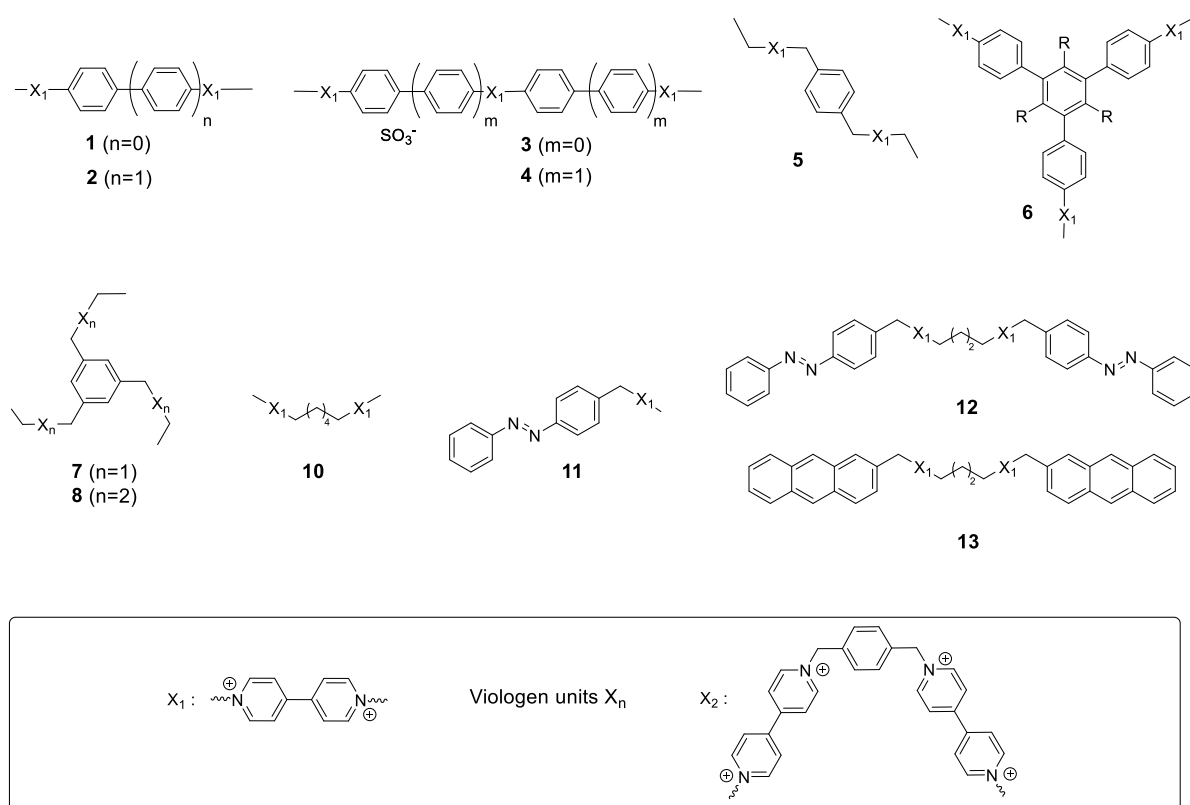

Figure 6. Viologen-based building blocks used for the construction of stimuli-responsive supramolecular polymers.

A mere handful of articles have been reported so far on stimuli-responsive supramolecular systems involving viologen and CBs as key building elements. In most cases, formation of 1D or 2D polymers rely on the intermolecular π -dimerization of two viologen cation radicals within the cavity of a CB[8] host. The self-assembly process, *i.e.* formation of the polymer, is thus triggered by chemical reduction of the viologen units. Another key point is the dimensionality of the self-assembled materials produced upon reduction. The latter is in fact determined by the structure of the viologen-based monomer: 1D linear polymers have been obtained from rigid bis-viologen compounds featuring linear structure (**1-4** in Figure 6) while

2D networks could be obtained from star shaped building blocks featuring at least three viologen units (**6-8** in Figure 6).

The groups of Li and Zhao have reported beautiful examples of redox-switchable assemblies built from a series of linear π -conjugated compounds incorporating two or three viologens connected through phenyl or bi-phenyl linkers (**1-4** in Figure 6).⁷⁰ They first found that these oligomers spontaneously self-assemble in aqueous media, even in quite diluted conditions ($5 \times 10^{-4} \text{M}$), upon addition of sodium dithionite, used as a reducing agent, to form linear 1D polymers. They have also established that the π -dimer-based self-assembly proceeds even more efficiently in the presence of one molar equivalent of CB[8]. The aggregation of the 1D polymers into bundles was also proposed to account for the micrometric diameter of linear molecular wires visualized by cryo-transmission electron microscopy (Figure 7).

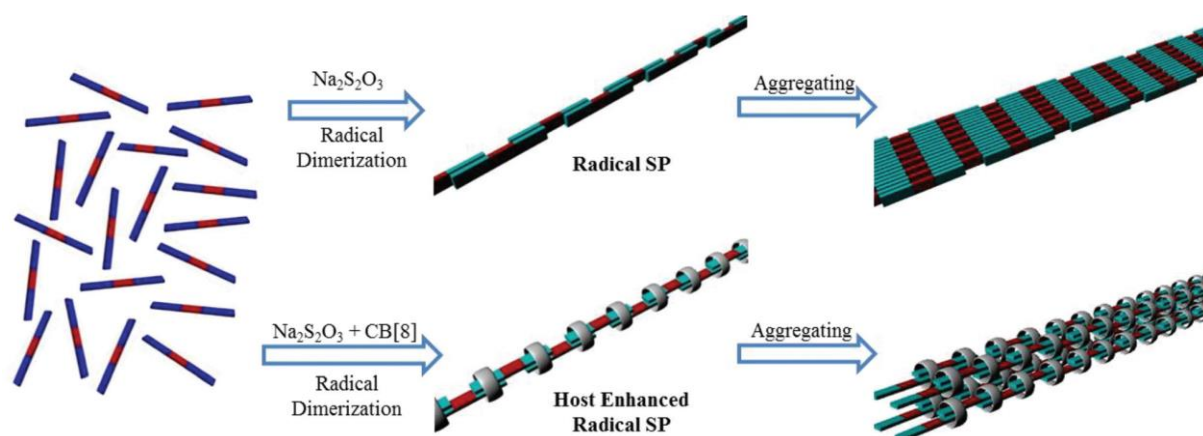

Figure 7. Cartoon representation of the rigid linear 1D-polymer structures generated upon reduction of **1** or **2** in the presence or in the absence of CB[8].⁷⁰ Reproduced by permission of The Royal Society of Chemistry.

A similar procedure applied to the star-shaped monomer **6** led to the formation of single layer honeycomb-like 2D networks whose structure was put forward on the ground of AFM, DLS and SAXD data.^{71, 72} Here again, addition of CB[8] was only found to improve the efficiency of the self-assembly process relying on the intermolecular π -dimerization of the chemically reduced viologen units. It should be mentioned that such 2D supramolecular organic frameworks (SOFs) have been obtained initially from a closely related monomer incorporating viologen-like units wherein each terminal pyridine rings are not quaternized.⁷³ In the latter case, supramolecular assembly most probably relies on the formation of CB[8]-

stabilized charge transfer complexes between two pyridine-pyridinium moieties arranged either head to head or head to tail.

Another redox-responsive 2D supramolecular framework has been reported by the group of Kathiresan⁷⁴ upon studying a series of flexible star-shaped poly-viologens (**5**, **7**, **8** in Figure 6). Reduction of the latter compounds with sodium dithionite led to the formation of π -dimerized species revealed by UV-Vis absorption measurements. As in previous cases, addition of CB[8] was only found to improve the efficiency of the self-assembly process as a result of the additional stabilization of the intermolecular dimer within its hydrophobic cavity. As a general statement, it should be noted that the formation of such 2D arrays is quite difficult to demonstrate in an unambiguous way and the proposed arrangement in the aforementioned examples remains unfortunately quite speculative.

A redox-triggered assembly/disassembly of a 1D supramolecular polymer built from the bis(p-sulfonatocalix[4]arene)**9**, CB[8] and the hexamethylene bridged bis-viologen**10**, has been reported by Liu and co-workers (Figure 8).⁷⁵

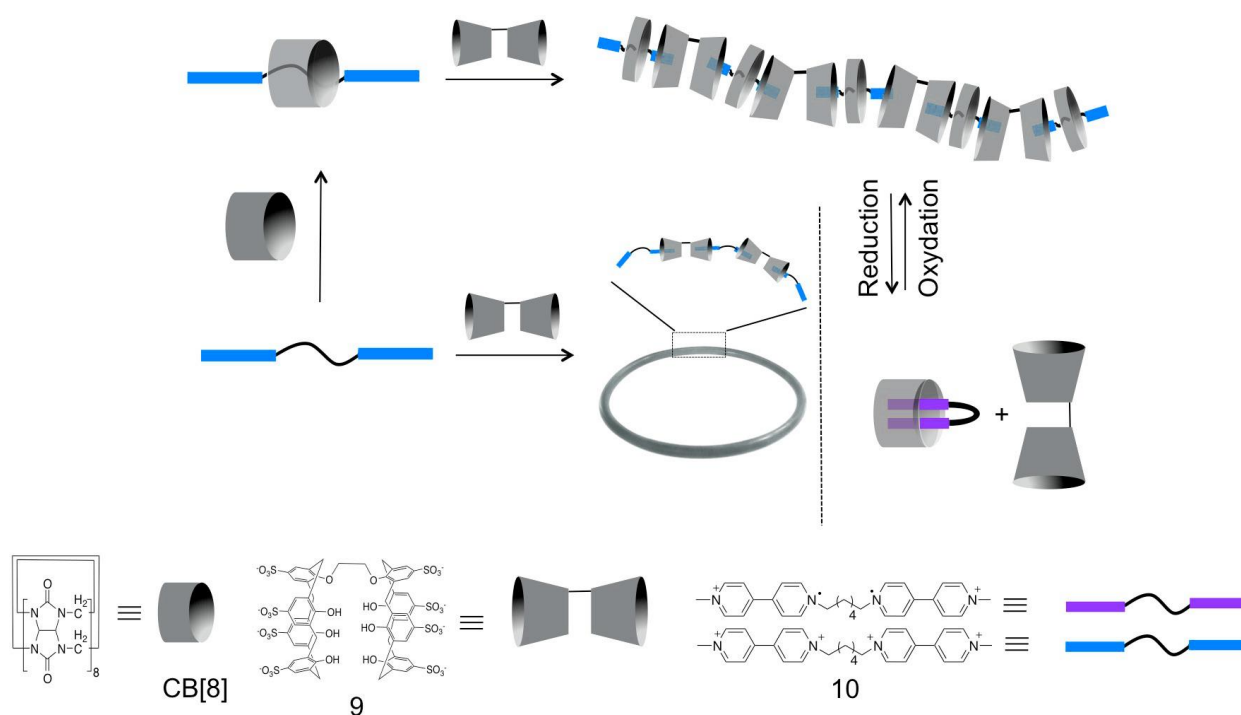

Figure 8. Schematic representation of the CB[8]-based self-assembly and of the effect of redox stimulation.⁷⁵

The authors found that the cyclic self-assembled oligomers produced from **9** and **10** can be converted into linear polymers upon addition of CB[8], the latter playing a key role in the

rigidification of the bis-viologenguest through the formation of the **10**@CB[8] rotaxane-like inclusion complexes. The 1D structure of the self-assembled ternary polymer is mainly supported by AFM measurements revealing the observation of linear nanostructures whose diameter seems in agreement with the size of the CB[8] host. Reduction of the viologen units embedded in the polymer backbone with an excess hydrazine was then found to trigger a dissociation of the linear supramolecular assembly, the driving force of the disassembly being the stabilization of a viologen radical π -dimer inside the cavity of CB[8].

Light has also been successfully used to trigger the association/dissociation of CB[8]-mediated viologen-based supramolecular polymers.⁷⁶⁻⁷⁸ Del Barrio et al. have established that the E isomer of the viologen-based guest **11**, bearing a photo-responsive azobenzene moiety, self-assembles into 1D polymers, both in solution and at the solid state. The X-ray structure of the linear supramolecular polymer isolated from CB[8] and **11** is shown in Figure 9. Another key finding is that depolymerization occurs upon photoisomerization of the guest (E \rightarrow Z) with UV light, as revealed by DOSY, small angle neutron scattering and static light scattering experiments. Similar results have been obtained with the bis-viologen derivative **12**.

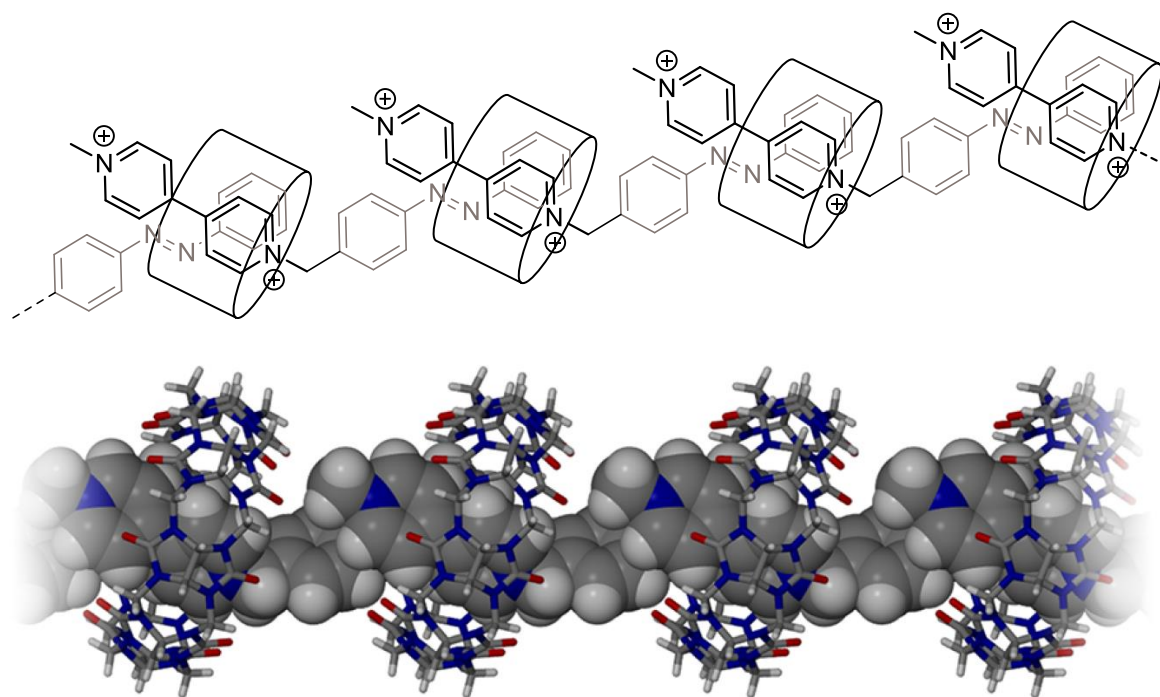

Figure 9. Schematic representation and side view of the X-ray structure of the linear supramolecular assembly obtained from **11** (Z isomer) and CB8.⁷⁶ Reproduced from Ref. 76 with permission from the American Chemical Society.

Following a similar approach, a photo-responsive supramolecular hyperbranched polymer has been obtained by self-assembly of the star-shaped compound **13**, incorporating an azobenzene unit and a viologen moiety on each branch (Figure 10).⁷⁸ As seen in the previous case, the assembly relies on the formation of host-stabilized charge-transfer complexes between the viologen units and the diazobenzene fragment behaving as the electron-rich donor fragment. The self-assembly and the morphology of the branched polymer could be tuned chemically, with the relative ratio of **13** and CB[8] introduced in solution, and by light, upon triggering the isomerisation of the diazobenzene moieties.

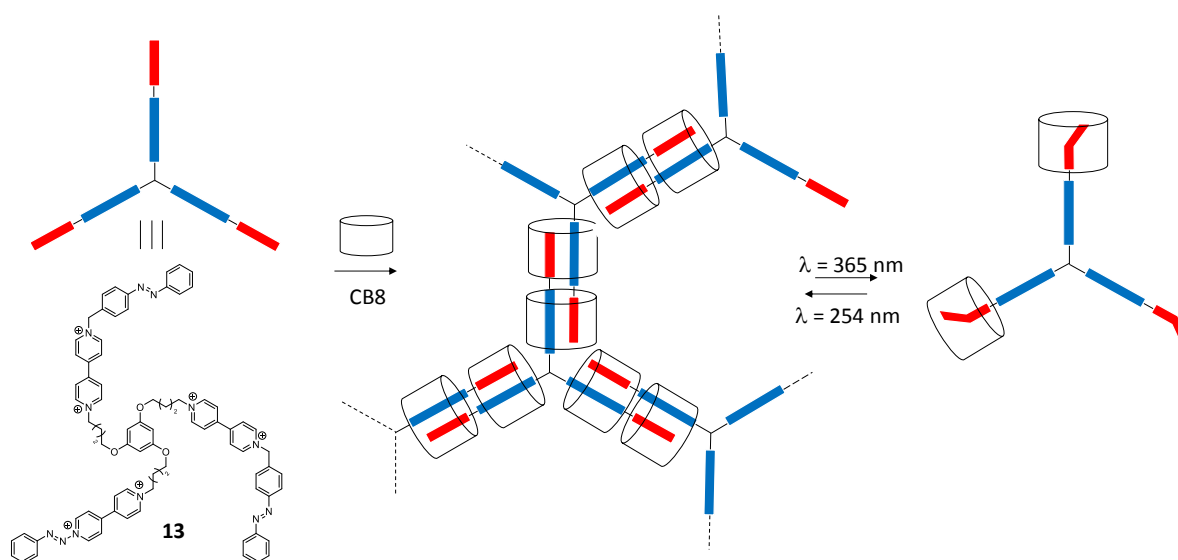

Figure 10. Schematic representation of the self-assembly process proposed with the star-shaped monomer **13** with CB[8].⁷⁸

Literature gives also a few examples of covalent polymers decorated by pendant peripheral organic groups using the affinity of cucurbiturils hosts for viologens. This approach is illustrated in Figure 11 with a CB[8]-promoted non-covalent grafting of α -mannoside-substituted viologens onto a 2-naphthol appended methacrylate copolymer (Figure 11).⁷⁹ Self-assembly relies here on the formation of a stable host-guest complex between the viologen and naphthalene-based recognition units within the cavity of CB[8]. The authors found that the latter complex, and hence the whole self-assembled system, can be fully dissociated by chemical reduction of the viologen moieties. They also report that the viologen appended polymer can be further self-assembled using the strong affinity of the pendant glycol for lectin (ConA), the formation of a supramolecular cross-linked network being mostly revealed by turbidity measurements.

We have focused in this section on fully soluble stimuli-responsive supramolecular polymers. Consideration must also be given to responsive assemblies involving formation/dissociation of vesicles or nanoparticle-containing assemblies. These specific studies will be discussed in the following paragraphs concerning dynamic supramolecular materials.

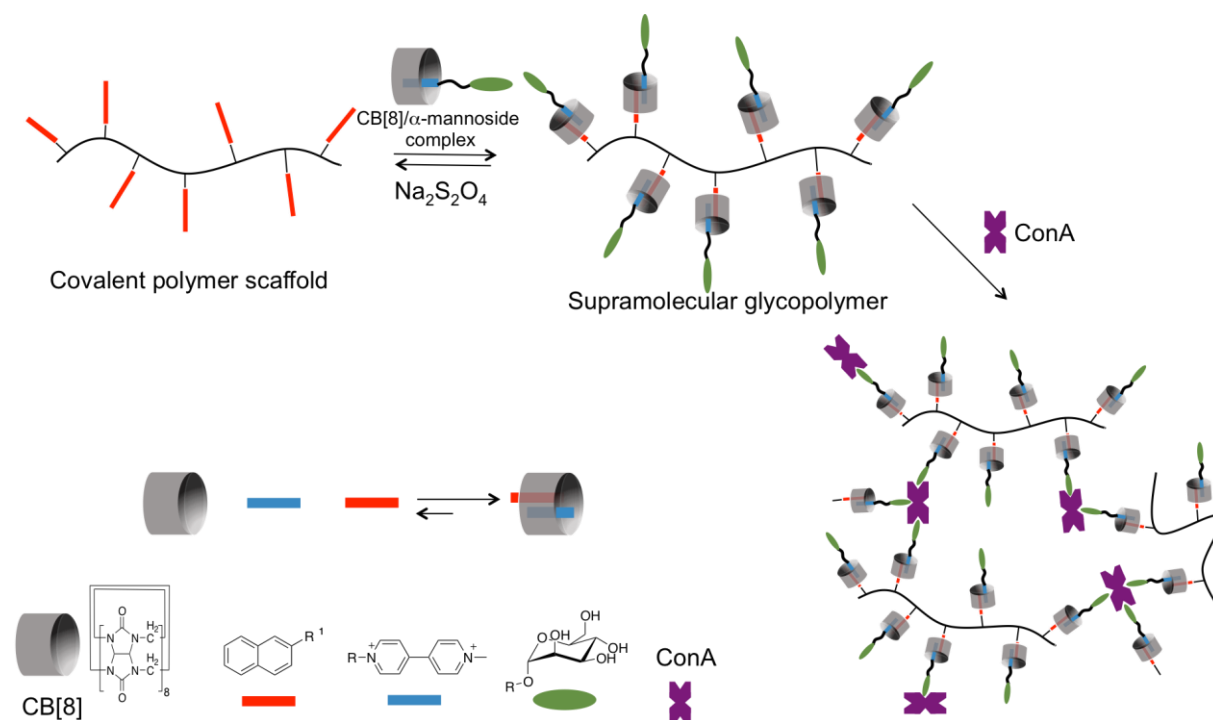

Figure 11. a) Reversible Formation of aviologene/CB[8]- glycopolymer conjugate and b) self-assembly of the glycopolymer with a manose-specific lectin (concanavalin A).⁷⁹

3. Towards dynamic supramolecular materials

a. Vesicles

The host-guest ternary complexation between CB[n]s, viologens and amphiphilic molecules can be used to tune the surface properties of cell membrane models. This strategy has been implemented to enhance the affinity for specific molecules without interfering in the biological functions of the cells. Cavatorta *et al.* have successfully used CB[8] hosts to immobilize blood cells on a methyl viologen-functionalized supported lipid bilayer. Cells have been found to specifically assemble on the bilayer through multivalent interactions only when CB[8] was present to drive the formation of ternary complexes.⁸⁰ Supramolecular assemblies between CB[n]s and viologens have also found interesting application in the fields of biomaterials and of nano-medicine. Vesicles and micelles modified with amphiphilic self-assembled structures have indeed been used to deliver bioactive molecule inside cells or to

enhance specific biological responses.^{81, 82} Such vesicles have been successfully employed to encapsulate fibroblast growth factor, extending its bioactivity without the necessity of excipients such as heparin.⁸³ Hetero-ternary complexes involving the host-guest CB[8]-maleimide-modified methyl viologen (MV) and azo-dyes have been self-assembled on the surface of giant vesicles to be used as models of optically active drug carriers for delivery to specific targets.⁸⁴⁻⁸⁶ On the other hand, Das and co-workers have established that different aromatic amino acids can form vesicles through ternary complexes with CB[8] and an amphiphilic viologens. They also report that vesicle formation is a peptide dependent process; with tryptophan forming stable vesicles while tyrosine and phenylalanine failing to do so.⁸⁷ Vesicles generated from diazobenzene-containing peptide have been shown to be tunable by a number of external triggers including the *trans-cis* isomerization of the azobenzene group upon irradiation with UV-light of 365 nm. The *Z/E* photo-isomerization was also shown to trigger the breakdown of the ternary complex and eventually to the disruption of the vesicle (Figure 12).⁸⁷

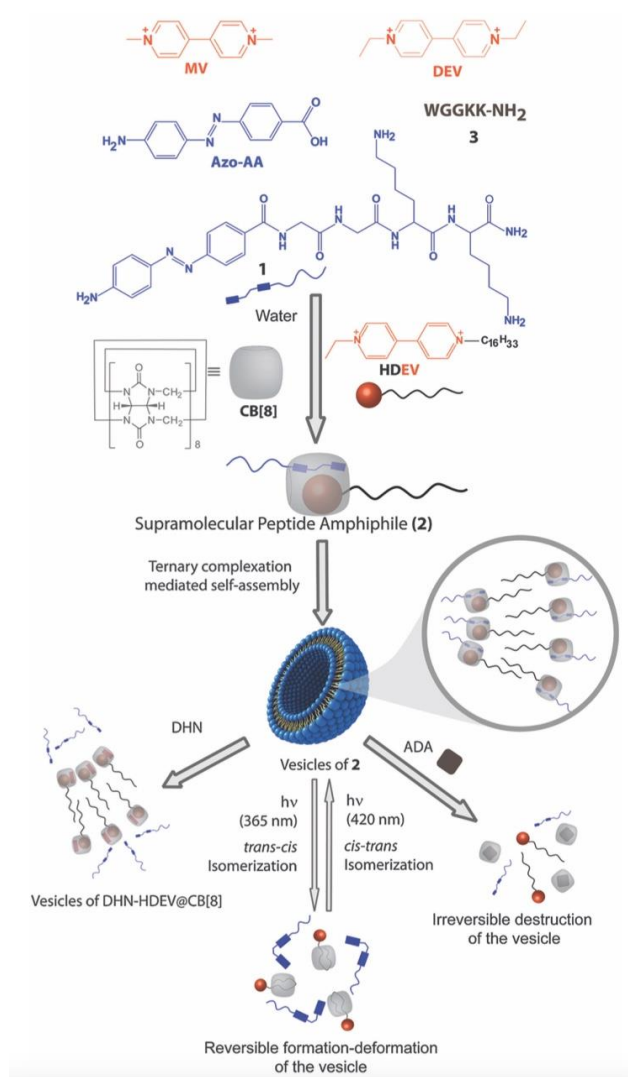

Figure 12. Chemical structures of Azo-AA ((E)-4-((4-aminophenyl)diazenyl)benzoic acid), DEV (N,N'-diethylviologen dibromide), HDEV (N-ethyl-N'-hexadecylviologen dibromide), and CB[8], pictorial presentation of the formation of supramolecular peptide amphiphiles (SPA) and its vesicle as well as responses to various stimuli.⁸⁷ Reproduced by permission of The Royal Society of Chemistry.

b. Hydrogels.

Self-assembly of CB[n] with viologens has been found, in certain circumstances, to foster the formation of hydrogels. Supramolecular hydrogels^{88, 89} are hydrophilic polymeric networks constructed from molecular monomers connected together through highly directional and reversible noncovalent interactions. The dynamic nature of these intermolecular bonds provides many fascinating characteristics including easy processability, reversibility, self-healing, and stimuli-responsiveness. Biocompatible hydrogels made from the cross-linking of biopolymers such as the polysaccharides also open exciting perspectives in biomedicine, food

and cosmetic technology.⁹⁰ The supramolecular character of the polymerization, while avoiding cross-linkers and limiting the numbers of reaction steps, makes the process more biocompatible, biodegradable and sustainable.

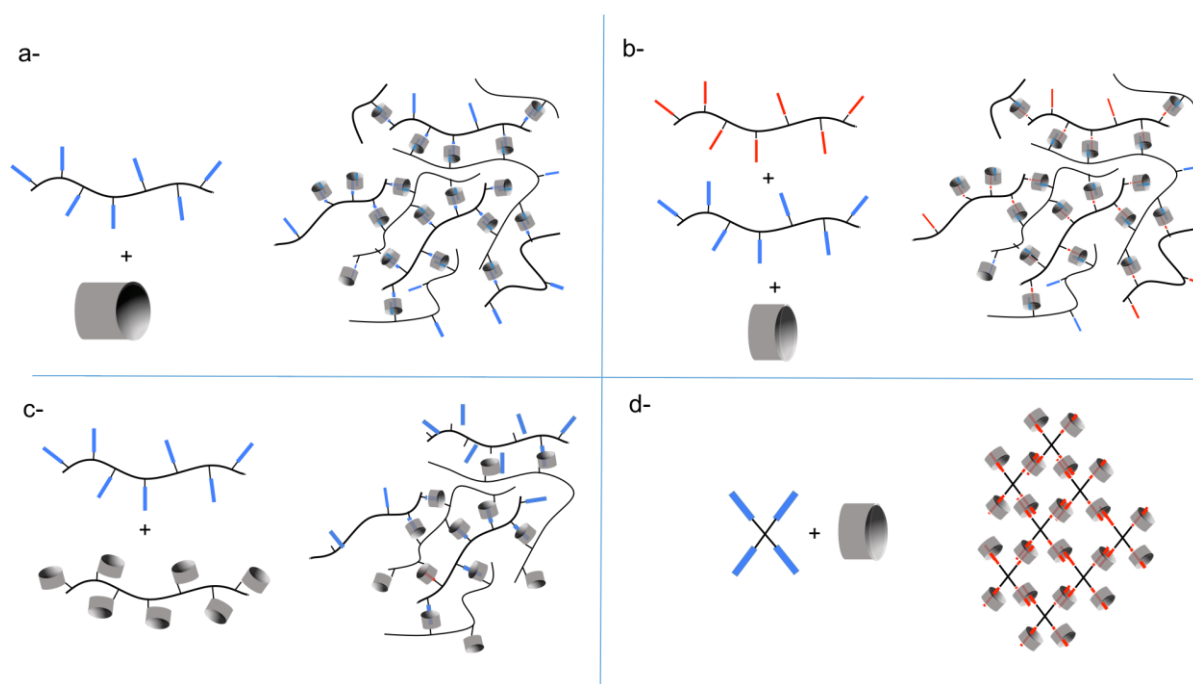

Figure 13: Four different patterns involved in the hydrogelation of CB[8]/viologen-based supramolecular assemblies.

CB[8] has been shown to trigger the formation of hydrogels through the formation of entangled supramolecular assemblies. Most CB[n]-based hydrogels reported so far in literature do not involve viologens as guests. Recent examples include polysaccharides based on hyaluronic acid or cellulose functionalized with pendant cysteine-phenylalanine dipeptides⁹¹ or *N*-(4-diethylaminobenzyl) branched chitosan⁹² forming stable gels upon addition of CB[8]. In the latter case, gelation results from the 2:1 host-guest binding mode depicted in Figure 13a. The large affinity between adamantane and CB[7] has also been used recently⁹³ to promote an effective cross-linking between two pendant *N,N*-dimethyl acrylamide based polymers bearing either CB[7] or adamantane substituents (Figure 13c). The different patterns encountered in literature are sketched in Figure 13.

Hydrogels involving viologens as guests have been obtained through the strategy depicted in Figure 13b. Scherman and coll. pioneered this approach in 2010 upon publishing the first example of hydrogels built from aCB[8]-mediated association of two copolymers functionalized either with viologen-based acceptors or naphthalene-based donors.⁹⁴ The resulting 1:1:1 supramolecular ternary complexes (CB[8]/viologen/naphthoxy) proved

particularly efficient to control the gelation kinetics, the cross-linking density and the properties of the material. This approach was further developed to optimize the formation, stability and properties of hydrogels obtained from (vinylbenzyl)trimethylammonium (positively charged) or styrene sulfonate (negatively charged) monomers forming a ternary complex with a viologen-appended styrenic monomer. The same authors have also carried out similar studies with a viologen-substituted renewable cellulosic-based polymer leading to stimuli responsive self-assembled hydrogels with ultra-high water content (up to 99.7%) (Figure 14).⁹⁵

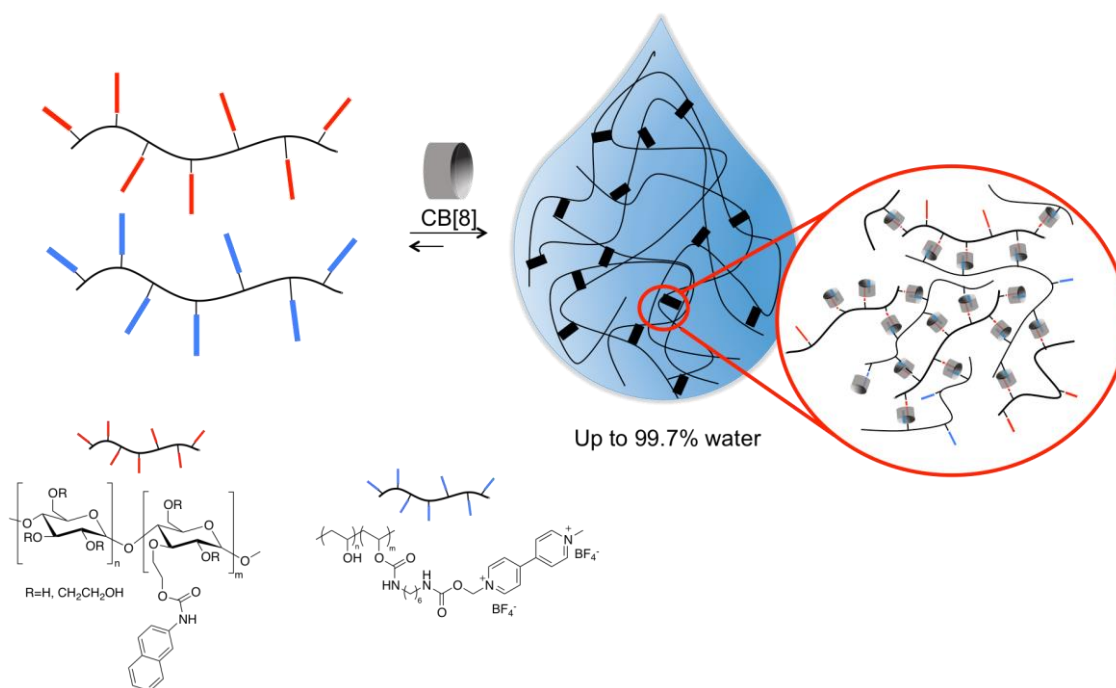

Figure 14 : Schematic representation of the 1:1:1 (CB[8]/viologen/naphthoxy) supramolecular ternary complexes yielding ultra-high water content hydrogels.⁹⁵

With the aim of developing efficient protein-based therapies, bovine serum albumin and lysozyme have been incorporated in such CB8/viologen-containing ultra-high water content hydrogels.⁹⁶ Contrary to the usual behavior encountered with regard to formulations at high concentrations in polymeric substituents, no strong burst release was observed with these high water content gels. Very recently, the same group managed to shape the three-components hydrogel as mono-disperse dehydrated beads using droplet-based microfluidics. In the presence of suitable amounts of CB[8], the beads, charged with fluorescein-tagged dextran during the droplet formation step, act as a model cargo retaining the fluorophore during re-hydration and releasing it rapidly upon addition of a competitive guest (1-adamantylamine).⁹⁷

Polymerization has also been achieved at the liquid/liquid interface upon formation of ternary complexes involving the viologen-based and diazobenzenepolytopic guests depicted in Figure 15, and CB8.⁹⁸ This supramolecular hyper-branched polymer could be dissociated upon photo-irradiation or addition of a competitive guest. This polymer formed at the surface of water droplets was also found to inhibit their coalescence.

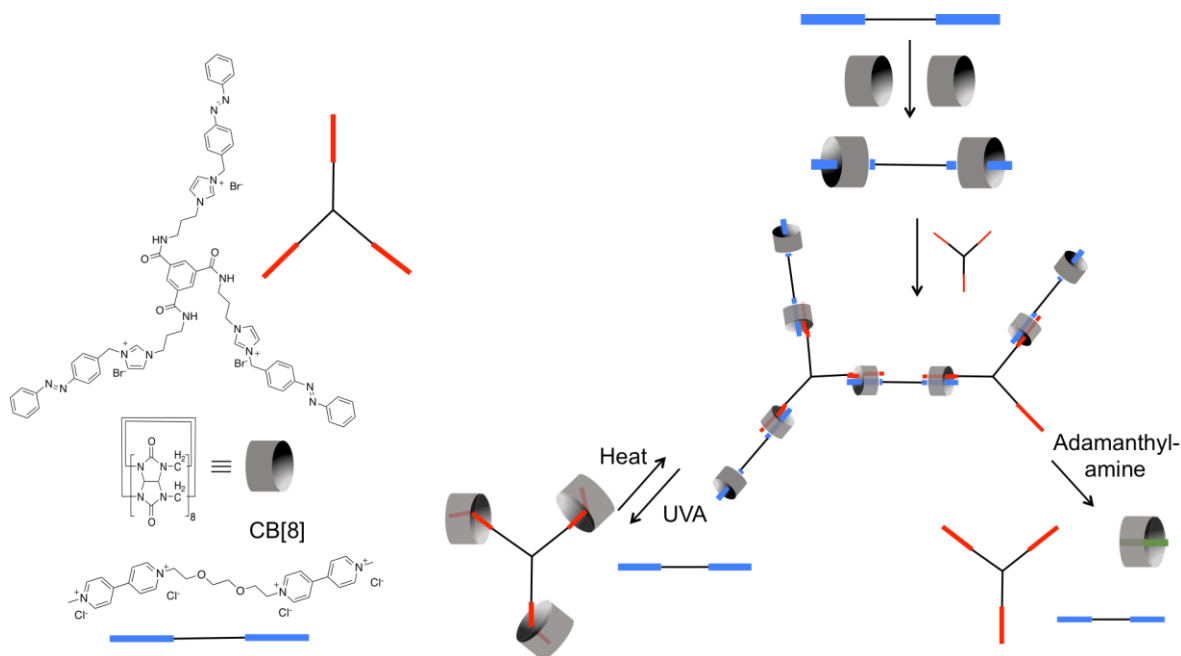

Figure 15 : Chemical structures and schematic representations of CB[8], the ditopic and tritopic monomers (left). Overview of the proposed assembly process forming the supramolecular highly branched polymer (SHP) (left). This SHP can be disassembled in response to either (i) reversible photoisomerisation of the azobenzene, or (ii) introduction of a competitive guest.⁹⁸

Tan and coworkers have recently prepared hydrogels using a highly branched hydrophilic backbone with superior viscoelastic modulus and thermal stability highlighted as a next generation of aqueous polymeric supramolecular CB[8]/viologen assemblies.⁹⁹ Their strategy is depicted in Figure 16: the usual three-components system (CB, donor, acceptor as depicted in Figure 13b) is replaced by a two-component system where CB[7 or 8] is threaded in polyrotaxanes structures.

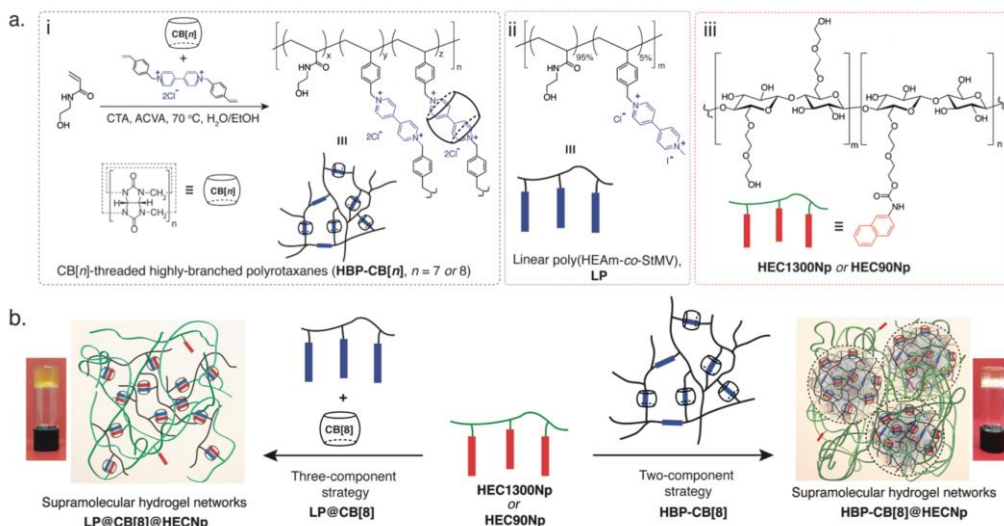

Figure 16 : a) Schematic illustration of i) synthesis of the highly branched $CB[n]$ -threaded polyrotaxane (HBP- $CB[n]$) via a semi-batch RAFT polymerization in the presence of $CB[n]$, ii) chemical structures of its linear analog (LP), and iii) naphthyl-functionalized hydroxyethyl cellulose (HECNp). b) Formation of hydrogel networks through a two-component strategy from HBP- $CB[8]$ polyrotaxane (HBP- $CB[8]$ @HECNp) or a three-component strategy from its linear analog (LP@ $CB[8]$ @HECNp). Inset: inverted vial tests for the hydrogel networks from.⁹⁹ Reproduced from Ref. 99 with permission from John Wiley and Sons.

Strictly speaking, the last two examples discussed below are not based on viologen units but rather on very similar, singly quaternized, structures. At basic pHs, poly(N-(4-vinylbenzyl)-4,4'-bipyridinium dichloride-co-acrylamide) forms hydrogels in the presence of $CB[8]$ following the association mode shown in Figure 13a, whereas acidic conditions induce a collapse of the 3D-network structure.¹⁰⁰ This investigation revealed that the 3D network hydrogel results from the formation of 1:2 $CB[8]$ /viologen binary complexes between a poly(N-(4-vinylbenzyl)-4,4'-bipyridinium dichloride-co-acrylamide) and $CB[8]$. The authors also demonstrate that the pore sizes within the xerogels decrease and the gel-sol transition temperature of hydrogels increases as the molar ratio of $CB[8]$ to viologen units of copolymer increases.

The tetradentate guest TPE (Figure 17) is a tetraphenylethylene compound decorated with four mono-charged viologens. In presence of $CB[8]$, this monomer was shown to afford binary complexes arranged into 2D-planar networks. These highly conjugated layers can stack on each other to form hydrogels. Those structures have been used to trap an aromatic anionic dye, namely the 8-hydroxypyrene-1,3,6-trisulfonic acid (HPTS).¹⁰¹

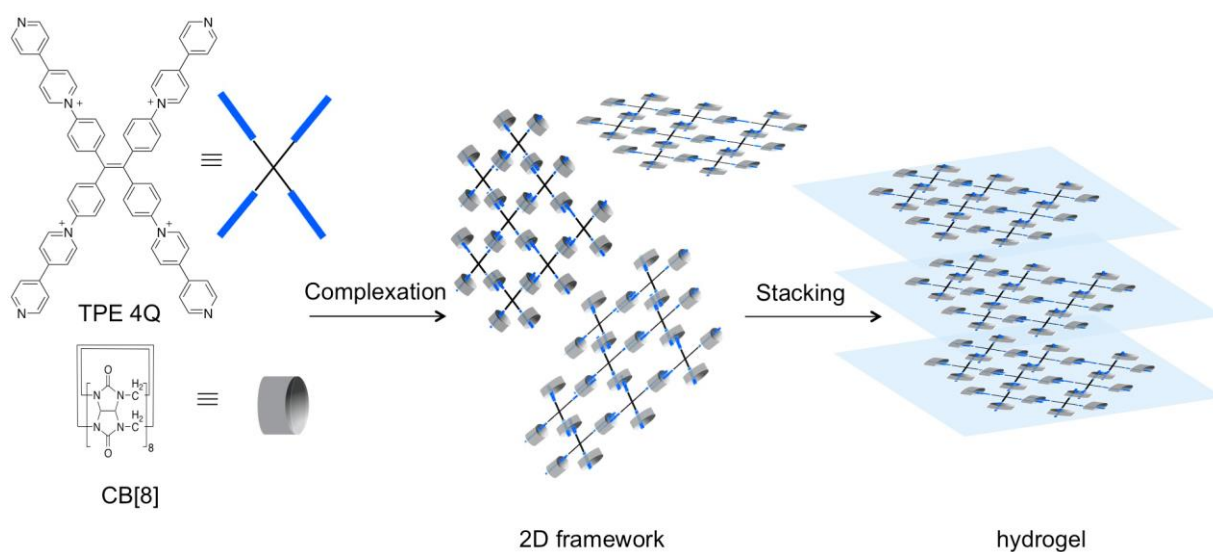

Figure 17. Hydrogel formation based on supramolecular assembly as 2D layers of a tetratopic guest and CB[8] followed by further inter layer stacking.¹⁰¹

c. Films, superlattices and nanoparticles

Self-assembled 1D chains, 2D sheets and 3D superlattices may be produced using viologen-based charge-transfer pairs included in CB[n], in a variety of ways, to achieve unprecedented complex sizes, structure-controlled arrays, and films. As a preliminary comment, it should be mentioned that a comprehensive review on nanoparticle arrays, held together by cavitands and host-guest interaction was provided recently by Li and Qi.¹⁰² Another one, concerning applications in medicine and healthcare, was published a few years ago by Zheng and his group.¹⁰³

Layer-by-layer assembly (LBL) is a very useful technique to prepare thin films involving ion pairs. The substrate is initially dipped in the cation or anion solution and then in a second solution containing the complementary charged component (Figure 18 a). This procedure has proved quite efficient to produce very thin and regular alternated charged lamellar materials. The introduction of CB[n]s allows the preparation of LBL films using solely cationic or anionic polymers. This principle was pioneered by Ji and his group in 2013 using viologen or indole-substituted poly(ethylenimine).¹⁰⁴ The viologen groups of the first polymer were included in CB[8] and this first component was deposited over the substrates. Dipping the latter sample in a solution of the second polymer, containing indole groups, led to the formation of CB[8] stabilized charge-transfer complexes between the viologen and indole groups, holding the cationic chains in the assembly in the form of PEI-MV@CB[8]/PEI-ID

(Figure 18 b). The growth of the film was followed by UV-vis absorption spectroscopy, ellipsometry and quartz microbalance over 12 bilayers, which proved stable over a wide pH range ($4 \leq \text{pH} \leq 9$). This work represents a very ingenious use of LBL technique to produce multilayer films from either with cationic or anionic components.

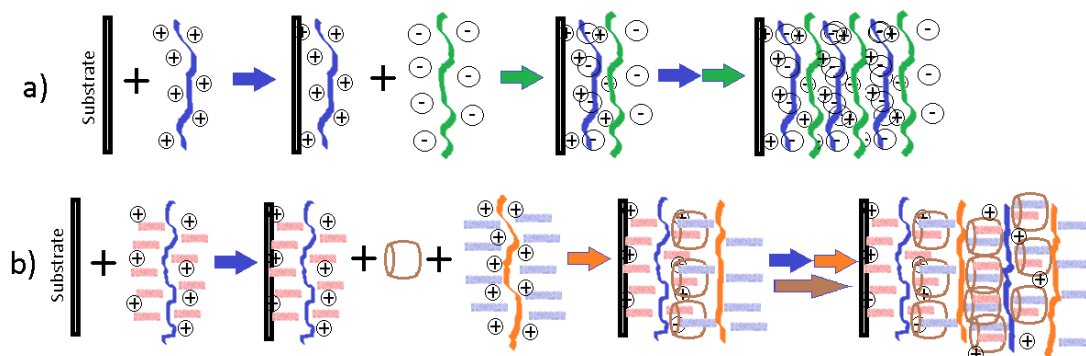

Figure 18 : Schemarepresentation of the LBL deposition technique for a): classical ion-pair formation, and b): Host-stabilized charge-transfer pair (HSCT) LBL.¹⁰⁴

It is well known that CB[n]s may act as growth regulators during nanoparticle synthesis.^{25, 26} They usually bind by adsorption onto the particles surface and prevent the indefinite growth of metals and oxides for example. Trabolsi and his group have used this property to prepare arrays of CB[7] surface-modified magnetic iron oxide nanoparticles using 1,1'-diphenyl-4,4'-bipyridinium(DPV) as a linker between adjacent nanoparticles forming dual host (2:1) ternary caviplxes (Figure 19). The same principle may be used with colloidal polymers based on poly(styrene). The hybrid assemblies may also be dissociated by reduction of the DPV moieties.^{105, 106}

Using the same approach, a series of micrometer scaled polymers containing particle clusters and arrays has been obtained by Abell and coworkers upon combining viologen- and naphthalene- modified particles in the presence of CB[8].¹⁰⁷

Gold nanorods (AUNRs) maybe aligned as wires, using $\{100\}$ end-functionalized nanorods bearing pendant viologen groups. A dinaphthoxy (NAox) telechelic linker was used to form charge-transfer stabilized caviplxes with CB[8], MV and NAox. The resulting head to tail aligned nanorod-based self-assembled oligomeric structures are clearly visible in TEM images. Such structures could not be observed with CB[7], due to its narrow size precluding insertion of two guests, nor in the presence of adamantine-amine, used as a competitive guest.¹⁰⁸

Zhang and coll. have shown that TiO₂ nanoparticles covalently functionalized with methylviologene substituents, can self-assemble in the presence of CB[8]. The latter process is triggered by the one-electron (chemical or photochemical) reduction of the viologen units yielding cation radicals getting stabilized in CB[8] as inter-particle π -dimers (Figure 20). This process has been shown to be fully reversible and to modulate the nanoparticles catalytic activity.¹⁰⁹

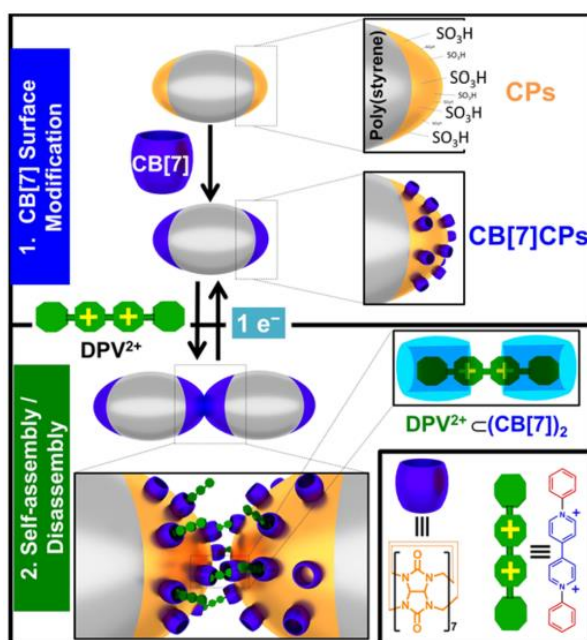

Figure 19: Self aggregation of polymeric colloidal particles using 2 hosts ternary cavipect and diphenylviologen (DPV).^{105, 106} Reproduced from Ref. 106 with permission from The American Chemical Society.

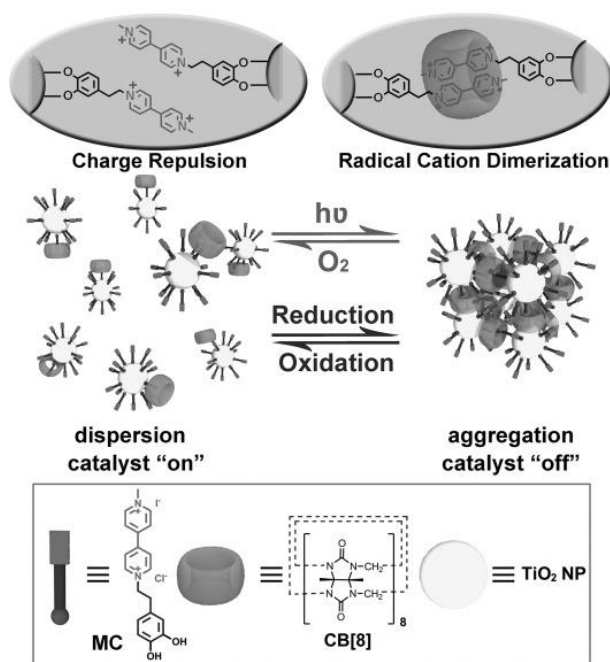

Figure 20: Reversible self-assembly of TiO_2 nanoparticles modified with methyl viologens and cucurbit[8]uril. Aggregation may be triggered by light, or chemical reduction to form radical cations. Reoxidation of the later causes disassembly.¹⁰⁹ Reproduced from Ref. 109 with permission from John Wiley and Sons.

A similar principle was used with metal-organic polyhedra (MOP) to deliver doxorubicin to cancer cells. A palladium MOP was prepared from $\text{Pd}(\text{NO}_3)_2$ and a methyl-viologen modified bipyridine ligand, which led to almost spherical MOPs with external MV pending groups. A doxorubicin pro-drug was then attached to the MOPs using naphthol residues and CB[8], forming charge-transfer pairs in hetero-guest caviplexes. The drug could be released by cleavage of an acid-sensitive acylhydrazone linkage in cellular medium.¹¹⁰

Supramolecular nanoparticles (SNP) have also been prepared from dendrimers such as poly(amidoamine) (PAMAM) modified with 8 terminal naphthol groups. Hetero-ternary caviplexes are formed in the presence of CB[8] and methyl viologen-poly(ethylene imine) (MV-PEI). Additional layers can also be added using the affinity of the remaining uncoupled viologen moieties for naphthol-poly(ethylene glycol) (Np-PEG), or for any other naphthol derivative, as demonstrated by Stoffelen and Huskens.¹¹¹⁻¹¹⁴ These procedures allow the obtention of monodisperse populations of self-assembled polymeric nanoparticles that could be used as carriers for example. A similar strategy has been produced patchy particles from colloidal carboxylated poly(styrene) clusters.¹¹⁵

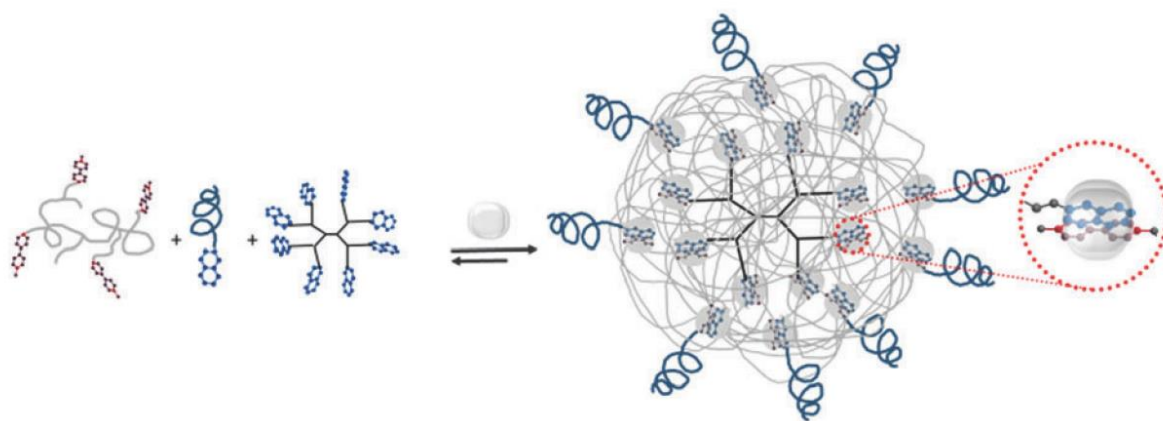

Figure 21: SNP formation starting from a first generation dendrimer (PAMAM) and other polymers.¹¹¹ Reproduced by permission of The Royal Society of Chemistry.

Shell-cleavable core-shell polymeric microspheres have been prepared by Scherman and his group using viologen-modified poly(acrylates) as scaffolds and CB[8] as supramolecular handcuffs to load different naphthol-appended polymers. The reversibility of ternary cavi-plex formation allows to hide or expose the inner polymer of the microsphere and to tune some key features as its cytotoxicity for example. The shell can be dismantled using amino-adamantane, which has a higher affinity for CB[8] than any other guest.¹¹⁶

A similar approach was used by the same group to produce polymeric gold nanoparticles composites, using thiol modified viologens grafted onto the gold surface and naphthol-functionalized polymers.¹¹⁷

Another interesting strategy relying on charge-transfer complexation to produce nanoparticle arrays involves the immobilization of CB[8]-containing pseudo-rotaxanes over surfaces. Dual composition nano-patterned brushes have been prepared by Scherman and co-workers employing CB[8]-rotaxanes as supramolecular linking agents on gold surfaces to control the adhesion of *trans*-Azo functionalized silica colloids onto the surface in a hexagonal arrangement (Figure 22).¹¹⁸ This strategy may be employed to purify peptides containing aromatic donors such as phenylalanine or tryptophan, as demonstrated by Scherman and coworkers,¹¹⁹ or to prepare surface patterns with functionalized nanoparticles.¹¹⁸ Surface patterning with nanoparticles may be achieved similarly, using axial ternary inclusion compounds through functionalization of the surface with thiol-appended viologens and CB[8]. The particles are then attached to the surface by use of electron-donating naphthol pendant groups.¹²⁰

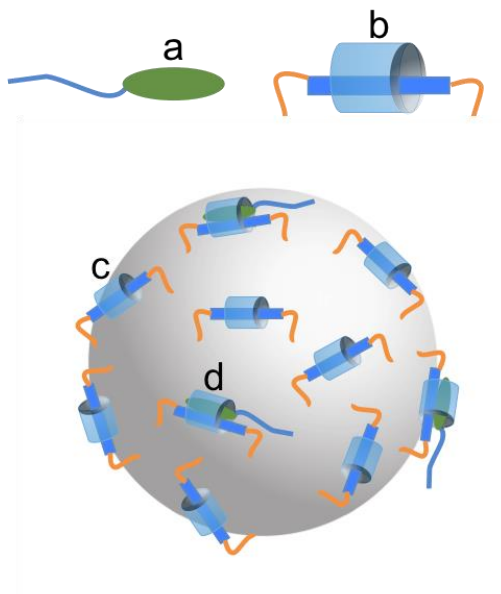

Figure 22: The catenane immobilization strategy over a spherical particle, a) an electron donor, b) a CB[8] pseudorotaxane containing a viologen core, c) the pseudorotaxane is immobilized, d) the pseudorotaxane accommodates the electron donor, forming a host-stabilized ternary charge-transfer complex.¹²⁰

4. Conclusion

This review has highlighted state-of-the-art achievements in the field of supramolecular polymers built from viologens and cucurbit[n]urils. The abundant literature on this subject reveal that those two building blocks can be self-assembled in a number of ways to form a variety of inclusion compounds featuring different stoichiometries and dimension. Due to size issues, only one viologen can be fitted inside the cavity of CB[7] to form a binary caviplex. This cucurbituril host can thus only be threaded on linear viologen-based oligomer/polymer strings or alternatively used in combination with a bis-viologen linker to promote the formation of polymeric structures. The ability of CB[8] host to form ternary homo or hetero-guest caviplexes has conversely proved far more suited to the development of 1D or 2D self-assembled supramolecular polymers. CB[8] can indeed either stabilize two viologen cation radicals as a π -dimer or two π -conjugated moieties forming a donor-acceptor charge-transfer complex. These ternary caviplexes moreover provide key directional, dynamic and responsive features to the self-assembled polymers. Most CB[8]-promoted assemblies can indeed be dismantled by equilibrium dynamics, in the presence of competitive guests such as adamantane or by simple reoxidation (with oxygen) of the viologen cation radicals. One approach towards viologene/CB[n]-based polymers involves « molecular handcuffs »,

wherein the macrocyclic host stabilizes and thus restrains the freedom degrees of the guests. This strategy and many other ones have been devised and successfully implemented to develop a wide range of supramolecular polymers and materials including stimuli-responsive vesicles, gels, nanoparticle arrays and shell-cleavable particles used for instance as responsive carriers for drug delivery.

Much remains to be done in the field of supramolecular polymers with cucurbiturils and viologens. The only obstacles to the further development of such dynamic materials and to their applications might well be the limited solubility of CB[8] in aqueous media and the synthetic locks currently limiting the functionalization of CB[n].

5. Acknowledgments

The authors thank the joint AUCANI (Universidade de São Paulo)-UdL (Université de Lyon) Seed Funding and by the COFECUB program (COFECUB Uc Ph-C 168-17) as well as the Universidade de São Paulo and the Ecole Normale Supérieure de Lyon (ENSL) for financial, logistical and administrative supports. FAPESP (2016/12666-1) and CNPq (309570/2015-8) are also acknowledged. CB also wishes to thank the ANR (ANR-12-BS07-0014-01) and the LABEX iMUST (ANR-10-LABX-0064) of Université de Lyon, within the program "Investissements d'Avenir" (ANR-11-IDEX-0007).

6. References

- 1 X.-Y. Hu, T. Xiao, C. Lin, F. Huang and L. Wang, *Acc Chem Res* **47**:2041–2051 (2014).
- 2 P. W. K. Rothmund, *Nature* **440**:297 (2006).
- 3 O. J. G. M. Goor, S. I. S. Hendrikse, P. Y. W. Dankers and E. W. Meijer, *Chem Soc Rev* **46**:6621-6637 (2017).
- 4 S. Dong, B. Zheng, F. Wang and F. Huang, *Acc Chem Res* **47**:1982-1994 (2014).
- 5 X.-Q. Wang, W. Wang, Y.-X. Wang and H.-B. Yang, *Chem Lett* **44**:1040-1046 (2015).
- 6 L. Yang, X. Tan, Z. Wang and X. Zhang, *Chem Rev* **115**:7196-7239 (2015).
- 7 X. Yang, H. Yu, L. Wang, R. Tong, M. Akram, Y. Chen and X. Zhai, *Soft Matter* **11**:1242-1252 (2015).
- 8 G. P. Moss, P. A. S. Smith and D. Tavernier, *Pure Appl Chem* **67**:1307 (1995).
- 9 L. Striepe and T. Baumgartner, *Chem Eur J* **23**:16924-16940 (2017).
- 10 Y. Wang, M. Frasconi and J. F. Stoddart, *ACS Cent Sci* **3**:927-935 (2017).

- 11 A. C. Fahrenbach, C. J. Bruns, H. Li, A. Trabolsi, A. Coskun and J. F. Stoddart, *Acc Chem Res* **47**: 482-493 (2014).
- 12 A. C. Fahrenbach, Z. Zhu, D. Cao, W.-G. Liu, H. Li, S. K. Dey, S. Basu, A. Trabolsi, Y. Y. Botros, I. W. A. Goddard and J. F. Stoddart, *J Am Chem Soc* **134**:16275-16288 (2012).
- 13 C. L. Bird and A. T. Kuhn, *Chem Soc Rev* **10**:49-82 (1981).
- 14 P. M. S. Monk, D. R. Rosseinsky and R. J. Mortimer, Electrochromic Materials and Devices Based on Viologens, in *Electrochromic Materials and Devices*, ed by P. M. S. Monk, D. R. Rosseinsky and R. J. Mortimer (2015).
- 15 D.-W. Zhang, J. Tian, L. Chen, L. Zhang and Z.-T. Li, *Chem Asian J* **10**:56-58 (2015).
- 16 C. Kahlfuss, E. Saint-Aman and C. Bucher, Redox-controlled intramolecular motions triggered by π -dimerization and π merization processes, in *Organic Redox Systems: Synthesis, Properties, and Applications*, ed by T. Nishinaga. John Wiley and sons, New-York, pp. 39-88 (2016).
- 17 J. Lagona, P. Mukhopadhyay, S. Chakrabarti and L. Isaacs, *Angew Chem, Int Ed Engl* **44**:4844-4870 (2005).
- 18 G. J.-F. Demets, *Quim Nova* **30**:1313-1322 (2007).
- 19 G. C. Bolfarini, M. P. Siqueira-Moura, G. J. F. Demets, P. C. Morais and A. C. Tedesco, *J Photochem Photobiol B: Biol* **115**:1-4 (2012).
- 20 G. C. Bolfarini, M. P. Siqueira-Moura, G. J. F. Demets and A. C. Tedesco, *Dyes Pigm* **100**:162-167 (2014).
- 21 K. R. K. K. Reddy, T. S. T. S. Cavallini, G. J. F. Demets and L. F. Silva Jr, *New J Chem* **38**:2262-2264 (2014).
- 22 C. B. Tovani, J. F. V. de Souza, T. S. Cavallini, G. J. F. Demets, A. Ito, M. B. Barioni, W. M. Pazin and M. E. D. Zaniquelli, *Colloid Surf, B* **111**:398-406 (2013).
- 23 F. A. Silva, F. Huguenin, S. M. de Lima and G. J. F. Demets, *Inorg Chem Front* **1**:495-502 (2014).
- 24 L. F. Stucchi da Silva, G. J.-F. Demets, C. Taviot-Gueho, F. Leroux and J. B. Valim, *Chem Mater* **23**:1350-1352 (2011).
- 25 E. M. S. dos Santos, L. S. Pereira and G. J. F. Demets, *J Braz Chem Soc* **22**:1595-1600 (2011).
- 26 L. F. S. da Silva, F. Leroux, C. Taviot-Guého, J. B. Valim and G. J. F. Demets, *Synth React Inorg Metal-Organic Nano-Metal Chem* **43**:1078-1082 (2013).

- 27 S. M. de Lima, J. A. Gomez, V. P. Barros, G. d. S. Vertuan, M. d. D. Assis, C. F. O. Graeff and G. J. F. Demets, *Polyhedron* **29**:3008-3013 (2010).
- 28 H. D. Correia and G. J. F. Demets, *Electrochem Commun* **11**:1928-1931 (2009).
- 29 M. C. Tadini, M. A. Balbino, I. C. Eleoterio, L. S. de Oliveira, L. G. Dias, G. J. F. Demets and M. F. de Oliveira, *Electrochim Acta* **121**:188-193 (2014).
- 30 J. Liu, Y. Lan, Z. Yu, C. S. Y. Tan, R. M. Parker, C. Abell and O. A. Scherman, *Acc Chem Res* **50**:208-217 (2017).
- 31 K. I. Assaf and W. M. Nau, *Chem Soc Rev* **44**:394-418 (2015).
- 32 A. Koc and D. Tuncel, *Isr J Chem* **58**:334-342 (2017).
- 33 C. Hou, Z. Huang, Y. Fang and J. Liu, *Org Biomol Chem* **15**:4272-4281 (2017).
- 34 E. Masson, M. Raeisi and K. Kotturi, *Isr J Chem* **58**:413-434 (2018).
- 35 Z. Huang and X. Zhang, Cucurbit[n]uril-Mediated Multiple Interactions, in *Multivalency: Concepts, Research & Applications*, ed by J. Huskens, L. J. Prins, R. Haag and B. J. Ravoo, pp. 143-152 (2018).
- 36 Y. Liu, H. Yang, Z. Wang and X. Zhang, *Chem Asian J* **8**:1626-1632 (2013).
- 37 L. Cao, M. Šekutor, Y. Zavalij Peter, K. Mlinarić-Majerski, R. Glaser and L. Isaacs, *Angew Chem, Int Ed Engl* **53**:988-993 (2014).
- 38 W. Ong, M. Gomez-Kaifer and A. E. Kaifer, *Org Lett* **4**:1791-1794 (2002).
- 39 W. S. Jeon, H. J. Kim, C. Lee and K. Kim, *Chem Commun* 1828-1829 (2002).
- 40 C. Kahlfuss, S. Denis-Quanquin, N. Calin, E. Dumont, M. Garavelli, G. Royal, S. Cobo, E. Saint-Aman and C. Bucher, *J Am Chem Soc* **138**:15234–15242 (2016).
- 41 C. Kahlfuss, E. Métay, M.-C. Duclos, M. Lemaire, A. Milet, E. Saint-Aman and C. Bucher, *Chem Eur J* **21**:2090 – 2106 (2014).
- 42 C. Kahlfuss, E. Métay, M.-C. Duclos, M. Lemaire, M. Oltean, A. Milet, E. Saint-Aman and C. Bucher, *C R Chimie* **17**:505-511 (2014).
- 43 C. Kahlfuss, A. Milet, J. A. Wytko, J. Weiss, E. Saint-Aman and C. Bucher, *Org Lett* **17**:4058-4061 (2015).
- 44 H. J. Kim, J. Heo, W. S. Jeon, E. Lee, J. Kim, S. Sakamoto, K. Yamaguchi and K. Kim, *Angew Chem Int Ed Engl* **40**:1526-1529 (2001).
- 45 M. Xue, Y. Yang, X. Chi, X. Yan and F. Huang, *Chem Rev* **115**:7398-7501 (2015).
- 46 Z.-J. Zhang, H.-Y. Zhang, L. Chen and Y. Liu, *J Org Chem* **76**:8270-8276 (2011).
- 47 J. Kim, Y. Ahn, M. Park Kyeng, D. W. Lee and K. Kim, *Chem Eur J* **16**:12168-12173 (2010).

- 48 W. Lee Jae, H. Ko Young, S. H. Park, K. Yamaguchi and K. Kim, *Angew Chem, Int Ed Engl* **40**:746-749 (2001).
- 49 H. Yang, J. Hao and Y. Tan, *J Polym Sci, Part A: Polym Chem* **49**:2138-2146 (2011).
- 50 F. Sakai, Z.-W. Ji, J.-H. Liu, G.-S. Chen and M. Jiang, *Chin Chem Lett* **24**:568-572 (2013).
- 51 U. Rauwald and A. Scherman Oren *Angew Chem, Int Ed Engl* **47**:3950-3953 (2008).
- 52 F. Biedermann, U. Rauwald, J. M. Zayed and O. A. Scherman, *Chem Sci* **2**:279-286 (2011).
- 53 S. Deroo, U. Rauwald, C. V. Robinson and O. A. Scherman, *Chem Commun* 644-646 (2009).
- 54 J. M. Zayed, F. Biedermann, U. Rauwald and O. A. Scherman, *Polym Chem* **1**:1434-1436 (2010).
- 55 L. Yiliu, Y. Ying, G. Jian, W. Zhiqiang and Z. Xi, *Angewandte Chemie International Edition* **49**:6576-6579 (2010).
- 56 L. Yang, Y. Bai, X. Tan, Z. Wang and X. Zhang, *ACS Macro Lett* **4**:611-615 (2015).
- 57 Z.-J. Yin, Z.-Q. Wu, F. Lin, Q.-Y. Qi, X.-N. Xu and X. Zhao, *Chin Chem Lett* **28**:1167-1171 (2017).
- 58 X. Zhang, C.-B. Nie, T.-Y. Zhou, Q.-Y. Qi, J. Fu, X.-Z. Wang, L. Dai, Y. Chen and X. Zhao, *Polym Chem* **6**:1923-1927 (2015).
- 59 L. Isaacs, *Acc Chem Res* **47**:2052–2062 (2014).
- 60 A. Iordache, R. Kanappan, E. Métay, M.-C. Duclos, S. Pellet-Rostaing, M. Lemaire, A. Milet, E. Saint-Aman and C. Bucher, *Org Biomol Chem* **11**:4383-4389 (2013).
- 61 A. Iordache, P. Melfi, C. Bucher, M. Buda, J.-C. Moutet and J. L. Sessler, *Org Lett* **10**:425-428 (2008).
- 62 A. Iordache, M. Oltean, A. Milet, F. Thomas, E. Saint-Aman and C. Bucher, *J Am Chem Soc* **134**:2653-2671 (2012).
- 63 A. Iordache, M. Retegan, F. Thomas, G. Royal, E. Saint-Aman and C. Bucher, *Chem Eur J* **18**:7648 – 7653 (2012).
- 64 R. Kannappan, C. Bucher, E. Saint-Aman, G. Royal, J.-C. Moutet, A. Milet, M. Oltean, E. Métay, S. Pellet-Rostaing, M. Lemaire and C. Chaix, *New J Chem* **34**:1373-1386 (2010).
- 65 J. M. Spruell, *Pure Appl Chem* **82**:2281–2294 (2010).
- 66 S. Abdul-Hassan Wathiq, D. Roux, C. Bucher, s. cobo, F. Molton, E. Saint-Aman and G. Royal, *Chem Eur J in press*:10.1002/chem.201802088 (2018).

- 67 C. Kahlfuss, T. Gibaud, S. Denis-Quanquin, S. Chowdhury, G. Royal, F. Chevallier, E. Saint-Aman and C. Bucher, *Chem Eur J* **in press**:10.1002/chem.201802334 (2018).
- 68 D. W. Zhang, J. Tian, L. Chen, L. Zhang and Z. T. Li, *Chem Eur J* **10**:56-68 (2015).
- 69 Y. H. Ko, E. Kim, I. Hwang and K. Kim, *Chem Commun* 1305-1315 (2007).
- 70 T.-G. Zhan, T.-Y. Zhou, F. Lin, L. Zhang, C. Zhou, Q.-Y. Qi, Z.-T. Li and X. Zhao, *Org Chem Front* **3**:1635-1645 (2016).
- 71 Zhang, L., T.-Y. Zhou, J. Tian, H. Wang, D.-W. Zhang, X. Zhao, Y. Liu and Z.-T. Li, *Polym Chem* **5**:4715-4721 (2014).
- 72 X.-L. Ni, S. Chen, Y. Yang and Z. Tao, *Journal of the American Chemical Society* **138**:6177-6183 (2016).
- 73 K.-D. Zhang, J. Tian, D. Hanifi, Y. Zhang, A. C.-H. Sue, T.-Y. Zhou, L. Zhang, X. Zhao, Y. Liu and Z.-T. Li, *J Am Chem Soc* **135**:17913-17918 (2013).
- 74 K. Madasamy, S. Vellaiahmaruthiah, D. Velayutham and K. Murugavel, *Scientific Reports* **8**:1354 (2018).
- 75 H. Qian, D.-S. Guo and Y. Liu, *Chem Eur J* **18**:5087-5095 (2012).
- 76 J. del Barrio, P. N. Horton, D. Lairez, G. O. Lloyd, C. Toprakcioglu and O. A. Scherman, *J Am Chem Soc* **135**:11760-11763 (2013).
- 77 T.-T. Cao, X.-Y. Yao, J. Zhang, Q.-C. Wang and X. Ma, *Chin Chem Lett* **26**:867-871 (2015).
- 78 L. Zou, Z. Yuan, D. Chang and X. Ma, *Dyes and Pigments* **143**:211-216 (2017).
- 79 J. Geng, F. Biedermann, J. M. Zayed, F. Tian and O. A. Scherman, *Macromolecules* **44**:4276-4281 (2011).
- 80 E. Cavatorta, M. L. Verheijden, W. van Roosmalen, J. Voskuhl, J. Huskens and P. Jonkheijm, *Chem Commun* **52**:7146-7149 (2016).
- 81 D. Jiao, J. Geng, X. J. Loh, D. Das, T. C. Lee and O. A. Scherman, *Angew Chem Int Ed Engl* **51**:9633-9637 (2012).
- 82 L. Yang, H. Yang, F. Li and X. Zhang, *Langmuir* **29**:12375-12379 (2013).
- 83 X. J. Loh, J. del Barrio, T.-C. Lee and O. A. Scherman, *Chem Commun* **50**:3033-3035 (2014).
- 84 Z. Yu, Y. Zheng, R. M. Parker, Y. Lan, Y. Wu, R. J. Coulston, J. Zhang, O. A. Scherman and C. Abell, *ACS App Mater Interfaces* **8**:8811-8820 (2016).
- 85 D. Wu, Y. Li, J. Yang, J. Shen, J. Zhou, Q. Hu, G. Yu, G. Tang and X. Chen, *ACS App Mater Interfaces* **9**:44392-44401 (2017).

- 86 C. Hu, N. Ma, F. Li, Y. Fang, Y. Liu, L. Zhao, S. Qiao, X. Li, X. Jiang, T. Li, F. Shen, Y. Huang, Q. Luo and J. Liu, *Appl Mater Interfaces* **10**:4603-4613 (2018).
- 87 J. H. Mondal, S. Ahmed, T. Ghosh and D. Das, *Soft Matter* **11**:4912-4920 (2015).
- 88 E. M. White, J. Yatvin, J. B. Grubbs, J. A. Billbrey and J. Locklin, *J Polym Sci, Polym Phys* **51**:1084-1099 (2013).
- 89 J. W. Steed, *Chem Commun* **47**:1379–1383 (2011).
- 90 A. S. Hoffman, *Adv Drug Deliv Rev* **64**:18-23 (2012).
- 91 M. J. Rowland, M. Atgie, D. Hoogland and O. A. Scherman, *Biomacromolecules* **16**:2436-2443 (2015).
- 92 Y. Lin, L. Li and G. Li, *Carbohydrate Polym* **92**:429-434 (2013).
- 93 H. Chen, S. Hou, H. Ma, X. Li and Y. Tan, *Scientific Reports* **6**:20722 (2016).
- 94 E. A. Appel, F. Biedermann, U. Rauwald, S. T. Jones, J. M. Zayed and O. A. Scherman, *J Am Chem Soc* **132**:14251-14260 (2010).
- 95 E. A. Appel, X. J. Loh, S. T. Jones, F. Biedermann, C. A. Dreiss and O. A. Scherman, *J Am Chem Soc* **134**:11767-11773 (2012).
- 96 E. A. Appel, X. J. Loh, S. T. Jones, C. A. Dreiss and O. A. Scherman, *Biomaterials* **33**:4646-4652 (2012).
- 97 X. Xu, E. A. Appel, X. Liu, R. M. Parker, O. A. Scherman and C. Abell, *Biomacromolecules* **16**:2743-2749 (2015).
- 98 A. S. Groombridge, A. Palma, R. M. Parker, C. Abell and O. A. Scherman, *Chem Sci* **8**:1350-1355 (2017).
- 99 C. S. Y. Tan, J. Liu, A. S. Groombridge, S. J. Barrow, C. A. Dreiss and O. A. Scherman, *Adv Func Mater* **28**:1702994-1703000 (2018).
- 100 H. Yang, H. Chen and Y. Tan, *RSC Adv* **3**:3031-3037 (2013).
- 101 X.-M. Chen, Y.-M. Zhang and Y. Liu, *Supramol Chem* **28**:817-824 (2016).
- 102 D. Li and L. Qi, *Curr Opin Colloid Interface* **35**:59-67 (2018).
- 103 Z. Wu, N. Song, R. Menz, B. Pingali, Y.-W. Yang and Y. Zheng, *Nanomedicine* **10**:1493-1514 (2015).
- 104 D.-d. Li, K.-f. Ren, H. Chang, H.-b. Wang, J.-l. Wang, C.-j. Chen and J. Ji, *Langmuir* **29**:14101-14107 (2013).
- 105 F. Benyettou, K. Nchimi-Nono, M. Jouiad, Y. Lalatonne, I. Milosevic, L. Motte, J. C. Olsen, N. i. Saleh and A. Trabolssi, *Chem Eur J* **21**:4607-4613 (2015).

- 106 F. Benyettou, X. Zheng, E. Elacqua, Y. Wang, P. Dalvand, Z. Asfari, J.-C. Olsen, D. S. Han, N. i. Saleh, M. Elhabiri, M. Weck and A. Trabolsi, *Langmuir* **32**:7144-7150 (2016).
- 107 X. Xu, F. Tian, X. Liu, R. M. Parker, Y. Lan, Y. Wu, Z. Yu, O. A. Scherman and C. Abell, *Chem Eur J* **21**:15516-15519 (2015).
- 108 S. T. Jones, J. M. Zayed and O. A. Scherman, *Nanoscale* **5**:5299-5302 (2013).
- 109 Q. Zhang, D. H. Qu, Q. C. Wang and H. Tian, *Angew Chem Int Ed Engl* **54**:15789-15793 (2015).
- 110 S. K. Samanta, D. Moncelet, V. Briken and L. Isaacs, *J Am Chem Soc* **138**:14488-14496 (2016).
- 111 C. Stoffelen and J. Huskens, *Chem Commun* **49**:6740-6742 (2013).
- 112 C. Stoffelen and J. Huskens, *Small* **12**:96-119 (2016).
- 113 C. Stoffelen, E. Staltari-Ferraro and J. Huskens, *J Mater Chem B* **3**:6945-6952 (2015).
- 114 C. Stoffelen, J. Voskuhl, P. Jonkheijm and J. Huskens, *Angew Chem Int Ed Engl* **53**:3400-3404 (2014).
- 115 E. Elacqua, X. Zheng and M. Weck, *ACS Macro Lett* **6**:1060-1065 (2017).
- 116 Y. Lan, X. J. Loh, J. Geng, Z. Walsh and O. A. Scherman, *Chem Commun* **48**:8757-8759 (2012).
- 117 R. J. Coulston, S. T. Jones, T.-C. Lee, E. A. Appel and O. A. Scherman, *Chem Commun* **47**:164-166 (2011).
- 118 C. Hu, Y. Lan, K. R. West and O. A. Scherman, *Adv Mater* **27**:7957-7962 (2015).
- 119 X. Ren, Y. Wu, D. E. Clarke, J. Liu, G. Wu and O. A. Scherman, *Chem Asian J* **11**:2382-2386 (2016).
- 120 F. Tian, N. Cheng, N. Nouvel, J. Geng and O. A. Scherman, *Langmuir* **26**:5323-5328 (2010).