



HAL
open science

How to evaluate the postural balance in a more efficient and less expensive way?

Gilberto Cuarelli, Alain Di Donato, Julia Misset, Adriana Gomes Lisboa de Souza, Vania Cristina Reisa Miranda, José Elias Tomazini, Guillaume Thomann

► To cite this version:

Gilberto Cuarelli, Alain Di Donato, Julia Misset, Adriana Gomes Lisboa de Souza, Vania Cristina Reisa Miranda, et al.. How to evaluate the postural balance in a more efficient and less expensive way?. 28th CIRP Design Conference, May 2018, Nantes, France. hal-01925903

HAL Id: hal-01925903

<https://hal.science/hal-01925903>

Submitted on 18 Nov 2018

HAL is a multi-disciplinary open access archive for the deposit and dissemination of scientific research documents, whether they are published or not. The documents may come from teaching and research institutions in France or abroad, or from public or private research centers.

L'archive ouverte pluridisciplinaire **HAL**, est destinée au dépôt et à la diffusion de documents scientifiques de niveau recherche, publiés ou non, émanant des établissements d'enseignement et de recherche français ou étrangers, des laboratoires publics ou privés.

28th CIRP Design Conference, May 2018, Nantes, France

How to evaluate the postural balance in a more efficient and less expensive way?

CUARELLI Gilberto^{a,b}, DI DONATO Alain^c, MISSET Julia^d, GOMES LISBOA DE SOUZA Adriana^a, DOS REISA MIRANDA Vania Cristina^b, TOMAZINI José Elias^b, THOMANN Guillaume^a

^a Univ. Grenoble Alpes, CNRS, G-SCOP, 38 000 Grenoble, France

^b Laboratório de Biomecânica - Faculdade de Engenharia de Guaratinguetá – FEG/UNESP, Brasil

^c Atelier Inter établissement de Productique, Grenoble INP, Grenoble, France

^d UFR de médecine - Université Grenoble Alpes, Grenoble, France

* Corresponding author. Tel.: +0-000-000-0000 ; fax:+0-000-000-0000. Guillaume.thomann@grenoble-inp.fr

Abstract

The assessment of postural control is important for the diagnosis and monitoring of balance disorder. Although there are qualitative and quantitative tools (Centre of pressure – CoP) for this evaluation. Some of them show limitations such as subjectivity or high equipment costs. The objective of this study is the preliminary validation of a more efficient and less expensive evaluation system with therapists. The method consists of finding similarities between CoP and CoM (Centre of Mass) during the evaluation of the postural balance with healthy people.

Results:

A user friendly human computer interface was developed, the low cost Microsoft Kinect V2 sensor was used to evaluate CoM and an unstable spring force platform was developed to evaluate CoP synchronously. For the comparison of data, a subject was evaluated under open eyes conditions in the unstable force platform. The test was performed using the user interface developed and the data collections showed evident similarities between CoP and CoM signals.

© 2017 The Authors. Published by Elsevier B.V.

Peer-review under responsibility of the scientific committee of the 28th CIRP Design Conference 2018.

Keywords: User-friendly measurement tool, Force platform, Kinect Sensor, Evaluation of postural balance.

1. Introduction

The amount of elderly people increase. Between 2015 and 2050, the population of 60-years-old-and-above people out of the global population will almost double, from 12% to 22% [1]. Moreover, this population has a high risk of falls. The risks of complications (fracture, rhabdomyolysis) and the fall's consequences (loss of independence, post-fall syndromes, dementia) are not trivial. Besides, the cost of falls is important

due in particular to the time of hospitalization, the surgery or the loss of independence.

It should be noted that there is a multitude of fall's risk factors out of the balance, like orthostatic hypo-tension, neurological or cardiac disorders, taking medicine, eyes and/or foot problem, cognitive impairment [2]. Many fall's risks factor are studying: the postural instability is one of the main risk factors, and it increases with aging [3].

It is relevant to realise specific and reliable diagnosis, to

prevent falls. There are already several clinical and functional balance tests used in clinic, particularly in physiotherapy, like the Berg Balance Scale, the Tinetti Balance Scale or the Timed Get Up and Go Test [4]. But, their results depend of the physiotherapists' interpretations and important difference inter-examiner exist. Moreover, some tests show limits due to low sensibility or specificity particularly to differentiate high and low fall of risks.

Since a couple of years, force platforms have appeared on the market. They are mostly used in research and give access to the patient's centre of pressure (CoP). In a previous study, it has been shown that force platform permit to quantify measure balance and to differentiate balance control among elderly and young people or to predict fall [5, 6]. But the cost and the understanding of the forces platforms limit their use in large-scale clinical settings. Most of the time, software linked to force platform is closed and not well understanding by the therapists. They have to base their diagnoses on numbers and curves they don't know the calculation process.

For a postural balance evaluation, the Berg's scale and others functional balance's test propose the following protocol to the patient. Each subject has to perform four tasks:

- Task 1: feet apart (gap of 20 centimeters)
- Task 2: feet together
- Task 3: feet in tandem
- Task 4: on one foot (preferential foot)

Each task will be performing under two-by-two conditions:

- Eyes Open
- Eyes closed

And

- Stable force platform
- Unstable force platform (except: on one foot/eyes closed and feet in tandem/eyes closed conditions, for safety reasons).

The position of the feet is standardized with feet externally rotated at their comfortable stance but with heel-to-heel distance fixed [7]:

- Task 1 : heels outside the line « 0,2 meter »
- Task 2 : heels on both side of the center line
- Task 3 : heels on the center line
- Task 4 : foot on the center line

The time of acquisition of the CoP and CoM signals is dependent on the task investigate [8]. We adapt the time of each task according to the difficulty.

Over the last few years, some inexpensive, reliable, precise cameras have emerged. There is a certain interest in the use of those cameras in medicine. It has been established that those tools can give the whole body Centre of Mass (CoM) excursion and velocity of a person [9]. Microsoft's Kinect sensor V2 (MK2) has an active infra-red camera and as a depth sensor (3D). The resultant technology has the ability to perform 3D tracking of head, trunk, limbs, and hands motion by tracking the location of 25 inferred joint centroids across the entire body. This technology may complement or replace the current forces platforms that are usually not satisfying physiotherapists.

The aim of the research project is to study data correlation between data from the force platform (CoP) and data from the

Mk2 (CoM). In this article, authors explained the design of the complete force platform-MK2 system associated to the user interface to be able to measure the CoP and CoM in the early stage of the project.

Most of the studies on the postural control use the CoP. For technical reasons, just a few studies use the CoP and the CoM together. The CoM's calculation is still a limit to be used in postural control's studies [10]. One recent research study uses force platform and MK2 sensor and a modified Berg Balance Scale (mBBS). The balance is evaluated in on a sitting position and several conditions are tested [11]. It shows correlations between the trunk centroids ("Spine_Mid", "Neck" and "Head") and the CoP centroid inferred by the force platform. Researchers have determined that the data recorded by the MK2 is sufficient to classify three distinct states of postural stability in a healthy individual performing the mBBS

We want to support this research by looking for correlations between CoP and CoM in standing position. We are going to collect data from MK2 and force platform built in our research laboratory, thanks to the achievement of balance's tests. The balance's tests are inspired by clinical scale like the BBS or the single leg balance test. The BBS was developed as a clinical measure of functional balance specifically in elderly population [5].

The benefit of this research will be to substitute the use of force platforms by inexpensive cameras present in low-cost technologies like the MK2. The aim is to spread the use of those tools, and the dedicated software, in rehabilitation centres. It is a quantitative and reliable detection method and it will permit in future, to detect fall-prone subjects.

The next section will present the materials and the method developed for this early stage of the project: the detail of the force platform, the user interface, the experimental setup and the collection of data. Then, the results presented consist of the first observation of the CoP and CoM correlation.

Centre of Pressure and Centre of Masse Definitions

CoP definition: the Center of Pressure is a point on a surface through which the resultant force due to pressure passes.

CoM definition: The Centre of Mass is the point at which the entire mass of a body may be considered concentrated for some purposes; formally, the point such that the first moment of a physical or geometric object about every line through the point is zero.

2. Materials and Methods

2.1 Materials

The force platform has been designed at the technological GI-Nova Centre (Grenoble). It is fit with four springs (the stiffness from 15N/mm to 25N/mm can be chosen), two electromagnetic suction cups that allow to lock and unlock the force platform [12]. Four load cells have been installed in order to measure the force repartition in real time (Fig. 1).

The NI USB-6008 data acquisition box from National Instrument was chosen. Indeed, it has the characteristics required to work with the previous components, at an affordable cost. It has eight analog inputs that can be used for single measurements or for differential measurements. In

addition, since LabVIEW's work software is from National Instruments, this greatly facilitates compatibility between our used hardware.

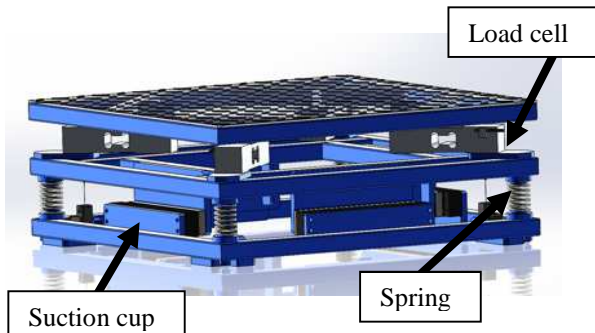

Fig 1: CAD model of the experimental platform developed in GI-Nova Centre.

The MK2 features a 1080p (for HD video acquisition) camera, an active infrared (IR) camera, and a depth sensor (for 3-Dimensional (3D) skeletal tracking constituted of 25 points). The acquisition software used was Labview software and the data were acquired at 33.3 Hz.

2.2. User Interface

An essential point of the experimental development concerns the easy interaction between the system and the therapist. With the participation of professionals from the health domain, a user friendly interface was proposed to manipulate the current materials (Fig 2.). Based on this version, researchers and therapists will iteratively increase the effectiveness of the manipulation. It is known that users accept

product only if they understand it. In the case proposed, they participate to the complete elaboration of the evaluation system (platform, user interface, data treatment, etc.). After numerous iterations, the complete proposition of the new evaluation system is proposed. The therapists' community understand the technical choices, the data treatment strategy and the user interface. The data analysis is done with the therapist and the researcher to find the better representations and restitution of results. The diagnosis proposed by the health professionals depends on the quality of this restitution.

This version of the interface is simplified to allow an easily understanding by the therapists. It is possible to identify on the Figure 2, the patient data area (Name, Age, Weight, Height and gender), the Kinect image and the joints points captured by the Kinect, the stabilization area (to choose the stability/instability of the platform), the selected test (position of the feet on the platform and eyes closed or eyes opened), the pressure sensor values area, and three graphs displayed in real time. Thanks to this displayed information, it is possible for the therapist to validate the effective subject detection before the registration.

2.3. Subjects

The current study was proposed not only to validate hardware technologies the dedicated software but also to verify coherence between CoP and CoM. Only one healthy subject is necessary in this stage. He has no history of neurological or vestibular disorder or serious musculo-skeletal injury, displayed healthy upper and lower limb function, is under the age of 65 and has sign consent form.



Fig 2. Human Computer Interface (HCI) designed with therapists.

2.4. Experimental Setup

Materials

For optimized tracking, subject is positioned in front of the MK2 placed (using a tripod) at a distance of approximately 2.5 meters from the center of the force platform and 1.4 meters from the floor [13, 14] (Fig. 3).

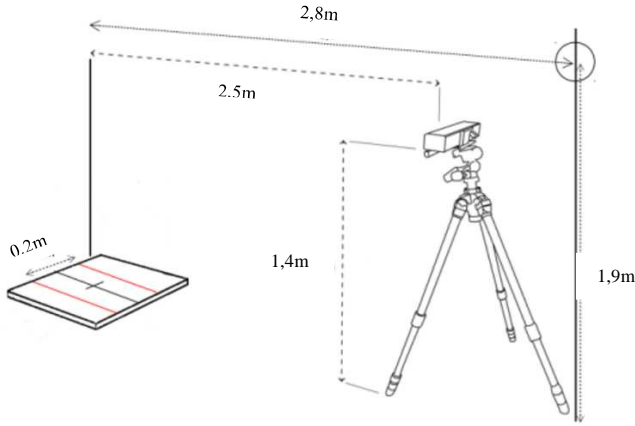

Fig. 3. Experimental layout for data collection: Subject standing on the center of a force platform at a distance of 2.5 meters from the MK2 [11].

The force platform is from 50 centimeters wide and 22 centimeters high. Marks indicate the position's feet on the force platform. The marks allow the position of the subject in the middle of the force platform and to control the gap between the feet during the different tasks.

A target of ten centimeter large is placed on the wall at eyes level and at 2,8 meter from the center of the force platform. To calibrate the force platform, several known mass were put on the centre of the force platform and the four sensors were calibrated.

Protocol

Subject is instructed to stand barefoot on the force platform in front of the MK2. He has to stand arms at their sides and eyes focused on the target on the wall. The position of the feet is standardized with feet externally rotated at their comfortable stance.

The proposed task consisted in a 20seconds activity: Positioned in vertical equilibrium on both feet, the subject must lean forward and then return to the vertical equilibrium position, then lean to the right and return to the vertical equilibrium position again. The subject was asked to repeat this sequence three times.

2.5 Data Collection

In this preliminary phase of the project, the objective is to find similarities between CoP and CoM signals. According to the therapist points of views, the experience has to show that the CoM signal given by the MK2 could be used as the reference for future diagnosis. Knowing this objective, simplified experimented situation has been proposed to be able to validate the proposal with therapists.

- First 5 sec and final 5 sec will be discarded.
- Start recording 5 sec before balance on one foot (to the right of the subject), go back to the middle of the platform, and balance to the front position.

- The subject was asked to repeat these sequence three times.
- Recording during movement and stop 5 sec after holding position on the center of the platform.

The analyzed variables were the amplitude variation of the CoP and the CoM oscillations in the AP (back and forward) and ML (left and right) directions. The figure 4 illustrates the ground reaction forces (R_1 to R_4) that are obtained by the platform for further calculation of the CoP's oscillation in the AP direction, represented by x_{CoP} , and ML, by y_{CoP} .

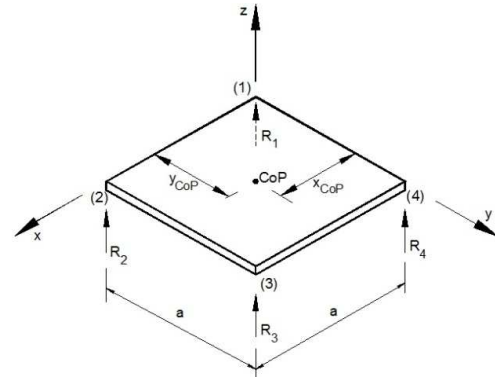

Fig. 4. Illustration of the ground reaction forces and the x, y and z for determining the direction and sense of x CoP and y CoP.

The data will be acquired with a sample rate of 33,3 Hz. To calculate the CoP coordinates from the four load cells, equivalence of forces is used (equation 1):

$$-\vec{R} = \sum_{i=1}^4 \vec{F}_i \quad (1)$$

Where \vec{R} is the weight of the body in the CoP's point and \vec{F}_i are the forces reactions at each springs.

And the equivalent torques are (equation 2):

$$-(\vec{r} * \vec{R}) = \sum_{i=1}^4 (\vec{r}_i * \vec{F}_i) \quad (2)$$

Projections on the \vec{x} and \vec{y} axes (equation 3) :

$$\begin{cases} x_{CoP} * R = (R_2 + R_3)a \Leftrightarrow x_{CoP} = \frac{a(R_2+R_3)}{R} \\ y_{CoP} * R = (R_3 + R_4)a \Leftrightarrow y_{CoP} = \frac{a(R_3+R_4)}{R} \end{cases} \quad (3)$$

And finally the CoP coordinates are (equation 4):

$$x_{CoP} = \frac{a(R_2+R_3)}{\sum_1^4 R_i} \quad y_{CoP} = \frac{a(R_3+R_4)}{\sum_1^4 R_i} \quad (4)$$

Where a is the distance between the load cells (240 mm in the present platform), and R_i ($i=1$ to 4) is the reaction measured at each load cell.

The MK2 provided 25 points of the human body that are used to calculate the CoM from equations (5) and (6)

$$COM_{segment} = Joint_{proximal} + (Joint_{proximal} - Joint_{proximal}) * R_{proximal} \quad (5)$$

$$COM_{total} = \sum COM_{segment_i} * P_i \quad (6)$$

To perform these calculations, data provided in Table 1 (for R and P) are used.

Data were collected according to the (x_{pt} , y_{pt} , z_{pt})-platform coordinates as a function of time. Then the amplitude of x_{pt} (ML), y_{pt} (AP), z_{pt} (vertical) were calculated, and the CoP represented.

Table 1. CoM position for each segment of the human body and their respective weight.

Segment	Joint proximal	Joint distal	R	P
head - neck	SpineShoulder	Head	1	0.081
torso	SpineBase	SpineShoulder	0.53 (0.5)	0.355
Pelvis	SpineBase	-	-	0.142
arms	Shoulder	Elbow	0.436	0.028
fore arm	Elbow	Wirst	0.43	0.016
hand	Hand	-	-	0.006
thigh	Hip	Knee	0.433	0.1
leg	Knee	Ankle	0.433	0.0465
foot	Foot	-	-	0.0145

The CoM position were also be calculated. The local (x_k, y_k, z_k)-Kinect coordinates referee was used. Correspondence between the two coordinatas systems is done by (Figure 5):

- $x_{pt} = x_k$
- $y_{pt} = -z_k$
- $z_{pt} = y_k$

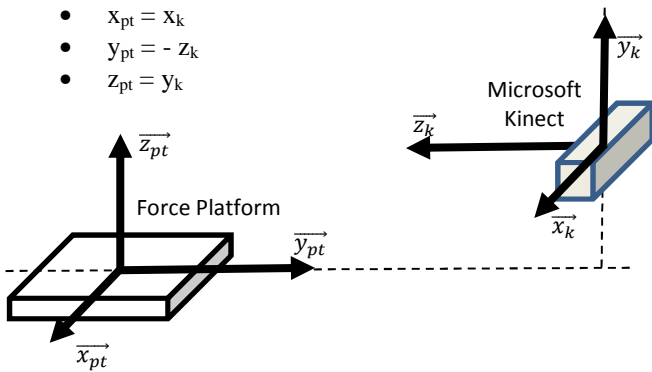

Fig. 5. Kinect coordinate system and platform coordinate system correspondence

3. Results

We have collected the (x, y) coordinates from the force platform and (x, y, z) coordinates from the MK2 as a function of time. A person, eyes-opened, standing in front of the MK2 and on the unstable force platform had perform the task.

The experiment has been done and the data collection analyzed. Figure 6 shows the four sensors signals (in volt) versus time (in sec). They represent the reaction measured at each load cell: R_i ($i=1$ to 4). From the protocol proposed, it is validated that the sensors 1 and 2 are in the x_{pt} direction and the sensors 2 and 4 are in the y_{pt} direction. This (x_{pt}, y_{pt}) reference mark corresponds to the CoP coordinate system and using the equation 1, it is possible to represent the figure 7.

In theory, CoP is the vertical projection of CoM. We decide to trace the both to verify it and to be able to propose a more effective and less expensive device to evaluate the postural balance to the medical community

This figure 7 is in concordance with the experience proposed. Firstly, the subject leans to his right, leaving the feet in contact with the platform. Then, he returns to the centre of the platform and then he leans forwards. He repeat this three times this actions, it is exactly what is shown on this figure 7. In this graph, the amplitude signal in the AP direction is about 0,02m and 0,04m in the ML direction

The figure 8 represents the CoM, in the ($x_k ; -z_k$) reference mark of the MK2 coordinate system. Again, the founded signal is in accordance with the experience proposed. In this graph, the amplitude signal in the AP direction is about 0,1m and 0,2m in the ML direction.

These two figures show that the signal amplitude has the

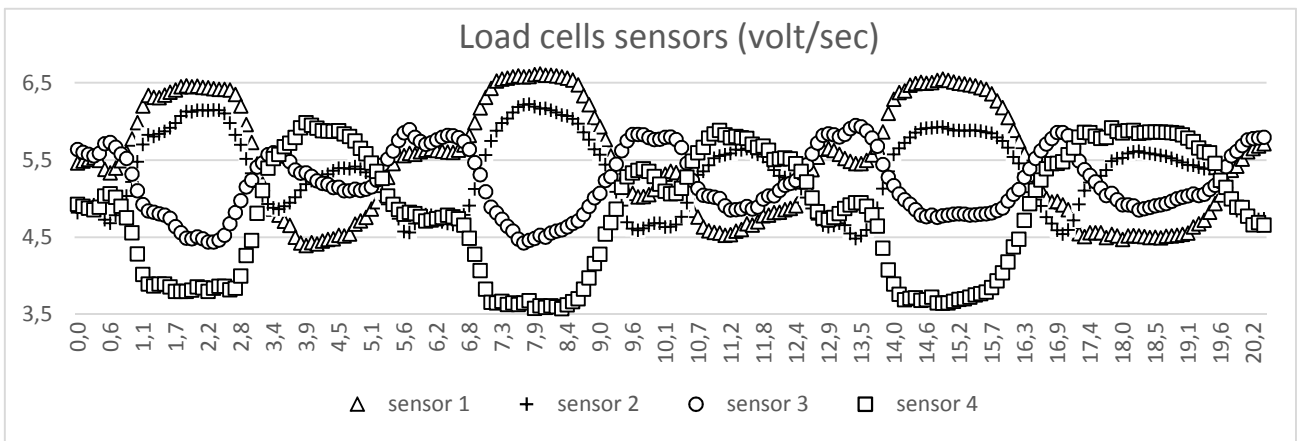

Fig 6. Four load cells signals in the task performed.

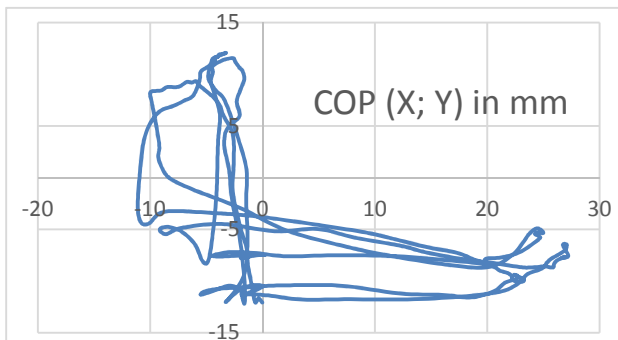

Fig 7. CoP point position calculated from the load cell signals.

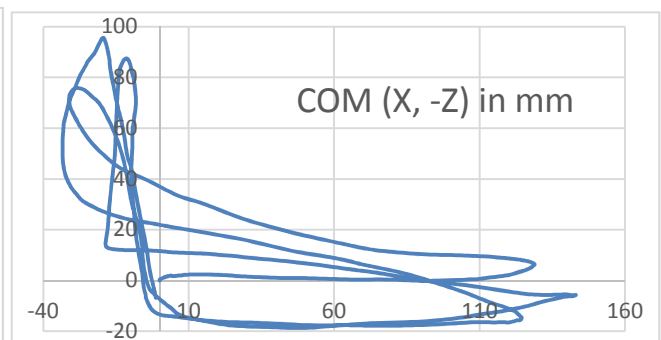

Fig 8. CoM point position in the(X; -Z) plane, measured by the MK2.

same global shape and is four times larger for the CoM than the CoP. The figures 9 compare the CoP and CoM signals in the same direction. They confirm the scale difference and the measurement correlation.

4. Discussion

During the pre-test, CoP and CoM during one protocole has been displayed. Some results were surprising but this pre-test permit us to synchronise both CoM and CoP. It also allows to decide the tasks which can be chosen to observe easily similarities between these signals. This phase was essential to argue with therapists. After explaining the experimental conditions and the signals representation, health professionals showed motivation to experiment more conditions with healthy subject. Very interesting results in an easy to understand proposed experience were obtained (similar shape of CoP and CoM signals in figures 7 and 8).

At this time, it is still difficult to discuss about the amplitude and the accuracy of these CoP and CoM information. Moreover, the accuracy of the CoM is non negligible because is between 20 to 40 mm depending of the trial. Moreover, the mean oscillation speed and the total oscillation area have to be analysed. These data are commonly used by therapist to evaluate the postural balance of patients.

During the last experimentations, an easy and complete manipulation of the system by the therapists was observed. They are able to configure the test, to launch the experiment and to register data autonomously. The last step consisting of analysing data is currently done with the assistance of researchers.

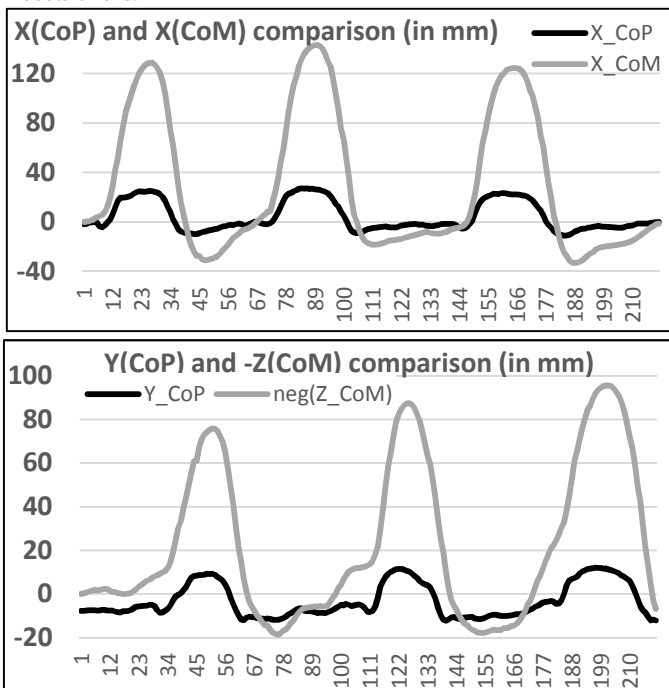

Fig 9. CoM and CoP respective positions.

5. Conclusion

This research consists of evaluating the postural balance in a more efficient and less expensive way. For that, the challenge is to validate obtained results with therapists. One way was

focused on the design of user friendly human computer interface (HCI) that allow the easy control of the system by the health professionals. The other way is currently to prove to this community that the numerical data obtained with the low-cost MK2 system is reliable and robust.

The pre-test permit us to collect synchronous CoM and CoP data in real time. Preliminary results clearly showed shape similarities of these two signals. The easy manipulation of the HCI by therapists and the collected results and very promising.

To confirm these interesting results, the next steps consist of realising more compete experiences with healthy subjects, following the standard protocol described before (positions of feet, open/closed eyes and stable/unstable platform). We will experiment the complete postural evaluation system on several subjects and under different conditions to be able to progressively validate this more efficient and less expensive proposal.

Then, the objective will be to add a video camera positioned at 90° of the Kinect sensor to validate the precision of the COM deviation. At the end, the system will be evaluated on a large number of patients.

References

- [1] World Health Organization, WHO - Les chutes. Available in: <http://www.who.int/mediacentre/factsheets/fs344/fr/>. Access: 2017.
- [2] Tinetti ME., Speechley M, Ginter SF. Risk factors for falls among elderly persons living in the community. The New England Journal of Medicine, 1988; 319; p.1701–1707.
- [3] Lord, S R., et al. Falls in older people: risk factors and strategies for prevention. Cambridge University Press, 2007.
- [4] Berg, K., Wood-Dauphinee S., Williams JL, Maki, B. Measuring balance in the elderly: Validation of an instrument. Canadian Journal of Public Health, July/August supplement 2:S7-11, 1992.
- [5] Era, P., Heikkinen E. Postural sway during standing and unexpected disturbance of balance in random samples of men of different ages. Journal of Gerontology; 1985;40:3; p. 287-295.
- [6] Piirtola M., Era P. Force Platform Measurements as Predictors of Falls among Older People – A Review. Gerontology 2006; 52; p.1–16.
- [7] Chiari L., Rocchi L., Cappello A. Stabilometric parameters are affected by anthropometry and foot placement. Clinical Biomechanics 2002;17-9; p. 666–677.
- [8] Duarte, Marcos; Freitas, Sandra MSF. Revision of posturography based on force plate for balance evaluation. Brazilian Journal of physical therapy. 2010;14-3; p. 183-192.
- [9] Eltoukhy M., Kuenze C., Oh J., Signorelli J.F. Validation of Static and Dynamic Balance Assessment using Microsoft Kinect for Young and Elderly Populations. IEEE Journal of Biomedical and Health Informatics, 2017.
- [10] Crétual A. Which biomechanical models are currently used in standing posture analysis? Neurophysiologie Clinique/ClinicalNeurophysiology ; 2015;45-4 ; p. 285-295.
- [11] Dehbandi, B et al. Using data from the Microsoft Kinect 2 to determine postural stability in healthy subjects: A feasibility trial. PloS one 12.2; 2017.
- [12] Miranda, VCR., Tomazini, JE., Martins, MS., Thomann, G. Evaluation of Balance With Test of Strategies of Balance on A Force Platform. In Congresso Internacional de Fisioterapia Manual, Joao Pessoa, Brasil, 2014.
- [13] Stone, EE., Skubic, M. Evaluation of an inexpensive depth camera for passive in-home fall risk assessment. Pervasive Computing Technologies for Healthcare (PervasiveHealth), 5th International Conference on. Ieee, 2011.
- [14] Khoshelham, K. Accuracy analysis of kinect depth data. In: ISPRS workshop laser scanning. 2011;12.