



HAL
open science

Thermomechanical modeling and simulation of a silicone gel for power electronic devices

Marion Haussener, Simon Cailhol, Baptiste Trajin, Paul-Etienne Vidal,
Francisco Javier Carrillo

► **To cite this version:**

Marion Haussener, Simon Cailhol, Baptiste Trajin, Paul-Etienne Vidal, Francisco Javier Carrillo. Thermomechanical modeling and simulation of a silicone gel for power electronic devices. *Microelectronics Reliability*, 2015, 55, pp.2045-2049. 10.1016/j.microrel.2015.06.116 . hal-01922534

HAL Id: hal-01922534

<https://hal.science/hal-01922534>

Submitted on 14 Nov 2018

HAL is a multi-disciplinary open access archive for the deposit and dissemination of scientific research documents, whether they are published or not. The documents may come from teaching and research institutions in France or abroad, or from public or private research centers.

L'archive ouverte pluridisciplinaire **HAL**, est destinée au dépôt et à la diffusion de documents scientifiques de niveau recherche, publiés ou non, émanant des établissements d'enseignement et de recherche français ou étrangers, des laboratoires publics ou privés.







Open Archive Toulouse Archive Ouverte

OATAO is an open access repository that collects the work of Toulouse researchers and makes it freely available over the web where possible

This is an author's version published in: <http://oatao.univ-toulouse.fr/20004>

To cite this version:

Haussener, Marion  and Cailhol, Simon  and Trajin, Baptiste 
and Vidal, Paul-Etienne  and Carrillo, Francisco Javier 
Thermomechanical modeling and simulation of a silicone gel for power electronic devices. (2015) *Microelectronics Reliability*, 55. 2045-2049. ISSN 0026-2714

Any correspondence concerning this service should be sent to the repository administrator: tech-oatao@listes-diff.inp-toulouse.fr

Thermomechanical modeling and simulation of a silicone gel for power electronic devices

M. Haussener, S. Caihol, B. Trajin ^{*}, P.E. Vidal, F. Carrillo

University of Toulouse, Laboratoire Génie de Production, ENIT-INP, BP1629, 65016 Tarbes Cedex, France

A B S T R A C T

The aim of the study is to develop some nodal models describing thermomechanical link in power devices. It is focused on modeling, simulating and testing a component: the silicone gel used in power electronics modules. Due to the future availability of high temperature gel, this study is a first step to establish a multi-physic model. The study aims to establish fast and compact electro-thermomechanical model than can be connected to circuit models, representing other packaging components. In the first stage, a finite element model of a commercial gel is defined and some simulation results are presented. In the second stage, an equivalent "electrical" compact model is also suggested and compared to measurements and 3D simulation results. The results presented concern temperature dispatching in both, simulations and measurements, and averaged stresses as well as displacement within the silicone. Future works will describe the thermomechanical link in nodal models, as well as real environment surrounding the silicone gel. Indeed, the silicone thermal expansion impact will be monitored.

Keywords:

Thermomechanical modeling
Encapsulating material
Power electronic device

1. Introduction

This paper deals with multi-physic modeling and simulation of power electronic components and modules. More precisely it is focused on the modeling approach to emphasize the electro-thermomechanical behavior of insulating materials used in power electronics assembly.

Indeed, as encountered in many transport applications, the aerospace industry aims at using more and more electrical equipment. The main idea is to substitute hydraulic and pneumatic systems with electrically fed devices. This lead to the increase in not only the number of power electronic device but also the power density of electronic modules due to mutualized power electronic functions. Moreover for additional reasons, the aerospace industry is looking forward to the emergence of wide band gap switches, allowing higher junction temperature. This increase of junction temperature will help in fulfilling the current density increasing requirements while reducing the size of the cooling system. However, these new devices will induce new constraints on the packaging material.

This study had been done within the French research program Genome-Premice, which aims at preparing the optimization of the design of on-board energy chains for a new generation of more electric aircraft. Our work takes part in tasks focusing on the evaluation and demonstration of new technologies. More precisely, our study deals with new insulating materials designed to remain functional at high temperature without any loss of performance.

Considering the temperature expected for these new devices with wide band gap switches, the silicone-based insulating materials are known to be the weak material of the assembly [1]. They experienced some specific failure modes [2] along with power module aging depending on the operating conditions.

Although electro-thermal link has been investigated [3], at the moment few studies developed combined electro-thermomechanical models for insulating layer, in order to be inserted in a more macroscopic behavioral simulation of power modules. The main purpose of this study is to develop generic multiphysic models for encapsulating materials. This model is applied in this paper on silicone polymer gel.

Extracted from experimental results, multiphysic behavioral models are developed and dedicated to the insulating material. Finally, the comparison allows validating both models. First, a 3D finite element modeling is defined which aims to obtain design rules for power electronic modules. Then, an equivalent electrical compact modeling is proposed for thermal simulation. This compact model is validated thanks to finite element simulation. Due to its formalism, it is mainly dedicated to observation and optimization. The compact model developed is based on automatic simulation tools and aims at allowing finer real-time control of power module cooling systems.

2. Silicon gels in power electronic modules

2.1. Power electronics modules generalities

The difficulty of power electronic module simulation comes from the number of components made of different materials as well as a wide

^{*} Corresponding author.
E-mail address: baptiste.trajin@enit.fr (B. Trajin).

range of scale (from 10 μm to 10 cm). All these components have their own functionalities and the whole module is exposed to multi-physic stresses. Indeed, as depicted in Fig. 1, rounding the semiconductor chip, one can find:

- metallic parts handling electrical conduction, thermal conduction, and/or mechanical holding;
- ceramic parts handling electrical insulation, thermal conduction, and/or mechanical holding;
- polymer parts handling electrical insulation and/or mechanical holding.

Most of the metallic or metallized parts are assembled thanks to solder joints. The difference of thermomechanical behavior of the materials involved combined with the device thermal cycling when used, leads to strong stresses on the components that can result in the module breaking. It is well known that these parts or attached materials are mostly studied.

2.2. Silicone gels

Silicone gels have wide thermal range, high thermal stability (>200 °C) and high dielectric strength (>10 kV/mm). Consequently, they are widely used in power modules for silicon power chip applications. Silicone gel studies are mainly focused on partial discharges or electrical insulating capability. Many studies dealing with aging of silicone gel used in power electronic modules under passive solicitation are also available. However, aging process under active solicitation, i.e. using power module as thermal source is rarely on concern [4]. This study is focused on the characterization and modeling of the silicone gels for the simulation of thermal and mechanical management of power modules. The role of this packaging power electronic component is to electrically insulate close parts of the module with different electrical potential (notably upper and lower faces of chips or wire bondings and power tracks depending on designed geometry).

Consequently, silicone gel should adhere to different surfaces on the power module and thanks to its hydrophobic properties it avoids penetration of air humidity in the module. Moreover, diffusion of oxygen is slowed down by the silicone gel. Consequently, corrosion of metallic materials due to the presence of water and oxygen in power module environment is limited [5]. It is also noticed that dust particles are indeed apart from active components.

Due to the role of silicone gel on thermomechanical behavior of power modules, their multiphysic properties and behavior have to be studied to ensure that power modules are properly operating while aging even at high voltage, current and temperature combined with dynamic current cycling. Their interaction and potential influence on other packaging components is under consideration.

3. Modeling

Thermal and mechanical modelings are expressed regarding electrical domain. The final aim of this choice is to allow modeling of a whole electro-thermo-mechanical system in a unique physic field.

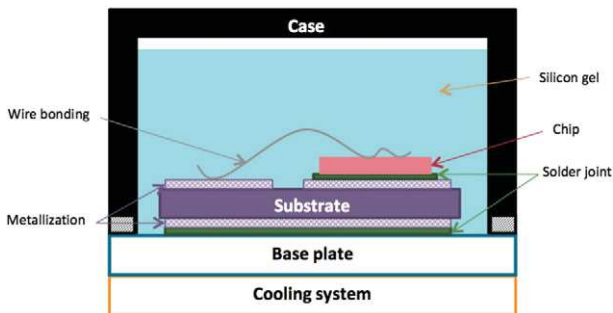

Fig. 1. Classical power electronics module architecture.

Finally a unique electrical equivalent model will simulate the electro-thermomechanical behavior of the whole assembly.

3.1. Thermal modeling

Thermal behavior of a system is given using heat equation (see Eq. (1)) where T is the local temperature, t is the time, k and α are coefficients depending on geometry and thermal properties of the material and r is a heat source.

$$\frac{\partial T}{\partial t} = -k \cdot \nabla^2 T + \alpha \cdot r \quad (1)$$

It can be demonstrated that this thermal behavior is equivalent to electrical circuit response composed of resistors representing spatial thermal conductivity, capacitors representing heat storage, voltage sources representing temperature sources and current sources representing heat sources [6].

Based on such idea, by dividing a volume into elements, a nodal model based on association of elementary equivalent electrical circuits may be obtained (see Fig. 2) [7].

Following that, a condensate mathematical form using matrix representation of nodal model is established (Eq. (2)), where T is a vector of local temperatures, C is a diagonal matrix of thermal capacities, A is the thermal resistances matrix, B is the command matrix and U is the vector of boundary conditions made of temperature or heat sources. In our study case only temperature sources are considered.

$$C \dot{T} = AT + BU \quad (2)$$

As each elementary volume have a non-null thermal capacity, C matrix is invertible, Eq. (2) is easily converted into state space representation as given in Eq. (3).

$$\dot{T} = C^{-1}AT + C^{-1}BU \quad (3)$$

This model is then simulated with classical state space simulator. Finally local temperatures at steady state are obtained by solving Eq. (3) with $\dot{T} = 0$.

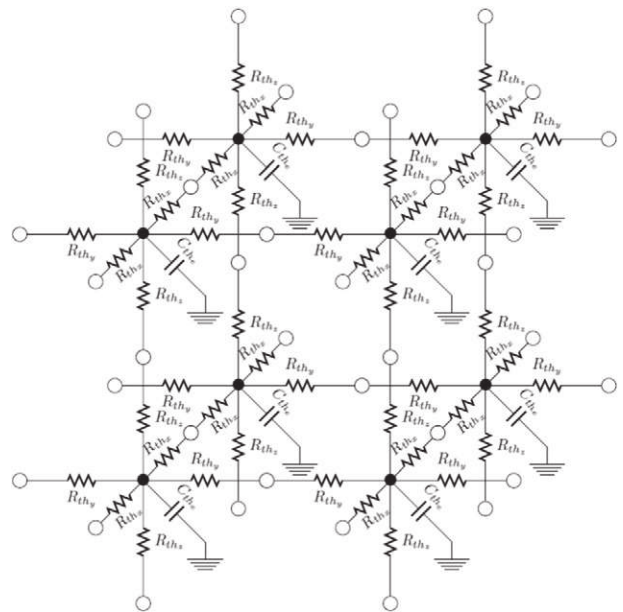

Fig. 2. Electrothermal nodal model of association of 8 elementary volumes.

3.2. Mechanical modeling

Mechanical behavior of viscoelastic silicon gels may be represented by a Burgers material model [8] as depicted in Fig. 3, where E denotes elastic modulus and η denotes viscosity.

Using electro-mechanical analogy [9], the viscoelastic Burgers model is modeled as an electrical circuit composed of resistors and capacitors. Indeed, damper of viscosity η and spring of stiffness E correspond to resistor of resistance η and capacitor of value $1/E$, respectively. Moreover mechanical subsystems connected in series (resp. parallel) are connected in parallel (resp. series) in the electrical domain. Finally, the Burger model leads to the equivalent electrical model presented in Fig. 4.

As for thermal behavior, a nodal equivalent model could be expressed according to Burgers material model. The model linking two neighbor nodes may be expressed by Eq. (4) resulting from electric circuit in Fig. 4, where $\dot{\epsilon}$ denotes the strain rate applied by the equivalent current source and $\dot{\sigma}_{1,2}$ denotes the derivative along time of the mechanical stress of the two springs (i.e. the two equivalent capacitors).

$$\begin{cases} \dot{\sigma}_1 = -E_1 \left(\frac{1}{\eta_1} + \frac{1}{\eta_2} \right) \sigma_1 + \frac{E_1}{\eta_2} \sigma_2 + E_1 \dot{\epsilon} \\ \dot{\sigma}_2 = \frac{E_2}{\eta_2} (\sigma_1 - \sigma_2) \end{cases} \quad (4)$$

Based on Eq. (4), it is obvious that the mechanical system can be expressed in one dimension by a system of coupled differential equations corresponding to a state space system. In two or three dimensions, a nodal model represented by a state space system may be established as for thermal behavior. The main difficulty lies in the coupling between the different spatial dimensions. Basically, this coupling is achieved through the Poisson's coefficient. However, this link has to be formalized regarding model in Eq. (4) in another study.

3.3. Thermomechanical modeling

The coefficient of thermal expansion (CTE) coefficient realizes the link between thermal and mechanical behaviors. It induces displacements depending on temperature and then mechanical stresses. Consequently, in Eq. (4), the input of mechanical model $\dot{\epsilon}$ must be correlated to thermal field (obtained thanks to the thermal model) through the CTE value of the concerned materials. This link is taken into account in finite element simulations performed in Section 5.

Moreover, as stated in [10], experimental measurements of the studied material demonstrate that dynamic modulus, which is linked to silicone gel viscosity η , depends on temperature, as depicted in Fig. 5.

This implies that coefficients in Eq. (4) depend on temperature leading to a non-linear system of differential equations. Nevertheless, in this paper, the variation of dynamic modulus according to temperature is neglected during finite elements simulations and the link between thermal and mechanical models is based on the thermal expansion.

4. Experimental thermal field

A Silgel® parallelepipedic block of dimension 30 by 35 mm length and 15 mm height is prepared in a mold by mixing two components to initiate cross-linking.

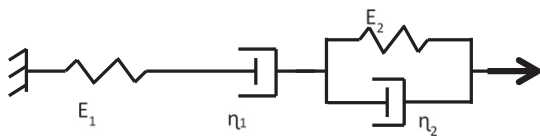

Fig. 3. Viscoelastic Burgers model.

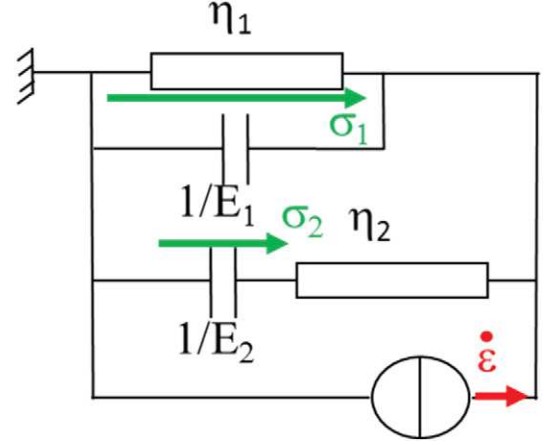

Fig. 4. Equivalent electrical circuit of Burgers model.

A particular care is given to the absence of air bubble in the block that could modify thermal properties and decrease insulation capability. To address this point, a careful attention is paid on the process. The cross-linking is realized for 1 h at 80 °C to avoid residual mechanical stress due to phase change of the material. This process is obtained after several DSC (Differential Scanning Calorimetry) monitorings which aims to check the lack of any further cross-linking that should develop specific residual stress. Several thermocouples are placed on the middle axis of the block at different heights before cross-linking. After cross-linking, the silicone block is unmolded and placed on a heating plate.

The obtained measurements are used to establish reference data for simulations validation. Fig. 6 shows the experimental setup with the silicone block fit with thermocouples placed on the hot plate. The temperature variation is set to ensure that the material has linear viscoelastic behavior.

5. Simulation results

Simulations are performed to determine physical fields inside of a silicone gel block. Thermal field allows the determination of hot points and mechanical fields lead to the verification of non-damage stress. Thermomechanical simulations are performed using finite elements commercial software. A silicone block with the same volume is modeled. Thermal and mechanical parameters are defined according to WACKER Silgel® 616 properties obtained through datasheet or by measurement. Main properties of this material are a density of 0.975, a viscosity of 250 mPa·s, a thermal conductivity of 0.2 W·m⁻¹·K⁻¹, a

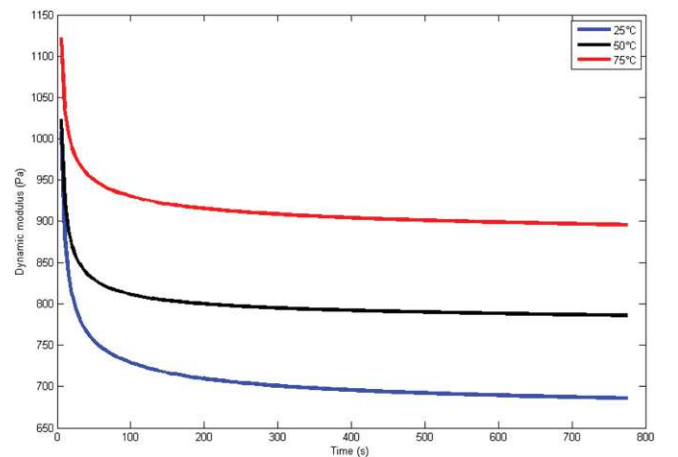

Fig. 5. Experimental measurements of dynamic modulus of silicone gel.



Fig. 6. Experimental setup for thermal measurements.

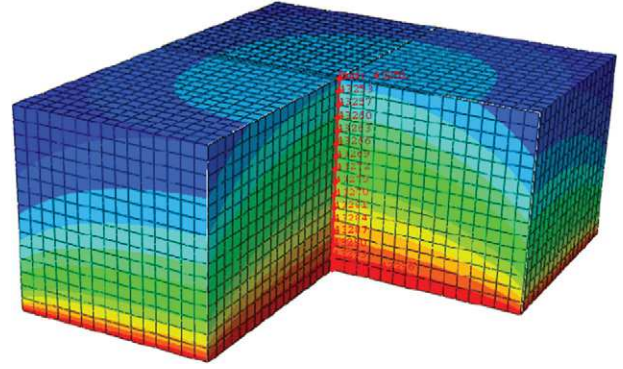

Fig. 7. Thermal field in silicone gel block.

Young's modulus of 5 kPa, a shear modulus of 1.73 kPa, and a Poisson's ratio of 0.446. These properties are used as parameters in thermal and thermomechanical simulations. These properties also allow us to define parameters of nodal thermal model and viscoelastic Burgers model.

A constant temperature of 74 °C is applied on the lower face of the block and an identical convection coefficient is applied on all other faces. The ambient temperature equals 18 °C. The convection coefficient is finally adjusted to ensure coherence of results between experimental and simulated data.

Modeling techniques allow simulating any boundary conditions. However, in this study, each face of the block is required to be fixed in translation and rotation. Even if these specific boundary conditions are voluntarily simple, it may correspond in a first approach to a silicone gel used for volume coating in power electronic devices, especially for sandwich power modules. It is mechanically linked to other packaging components due to its adhesive properties. Consequently, thermal elevation, mechanical stresses and displacements are due to external thermal constraint.

5.1. Thermal field

Fig. 7 depicts the thermal field inside of the silicone block obtained through finite element method. The thermal field is computed using 8-node linear bricks of volume 0.125 mm³. Highest (i.e. 74 °C) (resp. lowest i.e. 33 °C) temperatures are represented in red (resp. blue).

Due to symmetries of the system, the thermal field has a simple geometry.

Moreover, thermal field is also simulated using nodal model with solving Eq. (3) with cubic elements of volume 1 mm³. This simulation is performed to ensure that the proposed model is suitable for silicone gel block. The same parameters than for finite elements simulations are used. Thermal field is similar to the one depicted in Fig. 7. Comparison of experimental, finite elements and nodal method results is given in Table 1 in steady-state conditions and for given height points.

Moreover, regarding simple geometry and volumes used for elements in nodal model, it may be assumed that this representation is valid regarding results in Table 1. Moreover, it can be seen that the temperature gradient is almost constant in the silicone block along vertical middle axis.

5.2. Transient thermal response

The nodal model used through state space representation in Eq. (3) allows simulating the transient thermal response of the silicone block.

Fig. 8 depicts the temperature variation in the center of the silicone gel block at 0, 4, 7 and 10 mm from the heating plate.

5.3. Stress field

Using finite element thermomechanical simulations, Von Mises stresses are monitored inside of the silicone block using 10-nodes tetrahedron elements of volume 0.687 mm³. Stress field is depicted in Fig. 9 where the highest (i.e. 160 Pa) (resp. lowest i.e. 4 Pa) stresses are represented in red (resp. blue) in steady-state conditions.

As illustrated in Fig. 9, it is obvious that stresses have the highest values on boundaries due to non-displacement boundary conditions.

Moreover, the highest stresses are lower than the elastic modulus of Silgel® 616, ensuring the absence of mechanical degradations inside of the silicone block due to thermal constraints.

5.4. Displacement field

Displacement field inside of the silicone block is depicted in Fig. 10 where the highest (i.e. 113 μm) (resp. lowest i.e. 0 μm) displacements are represented in red (resp. blue) in steady state-conditions.

It can be observed in simulation that maximal displacement reaches about 100 μm in the middle of the block. This maximal displacement is close to the dimension of power electronic parts such as wire bondings and is located near to the wire bonding location. Consequently, depending on adhesive properties of silicone gel on different surfaces of materials, displacement of silicone gel could mechanically interact with thin wire bondings. Thus, it is not excluded that mechanical stresses may be strengthened within fragile elements such as wire bondings due to thermomechanical effects in silicone gel. It can be imagined that these phenomena could participate either to mechanical fatigue or break of wire bonding welding or silicone gel crack occurrence nearby wire bondings. This assumption should be verified through adherence tests and displacement measurements.

Table 1

Temperature values inside of silicone gel block and relative error between simulations and measurements.

Height (mm)	Finite elements simulation (°C)	Nodal simulation (°C)	Measurements (°C)
0	74–0.27%	74–0.27%	74.2
4	62–0.8%	63.2–1.1%	62.5
7	53–1.8%	54.6–5%	52.0
10	46–2.5%	46.9–0.6%	47.2

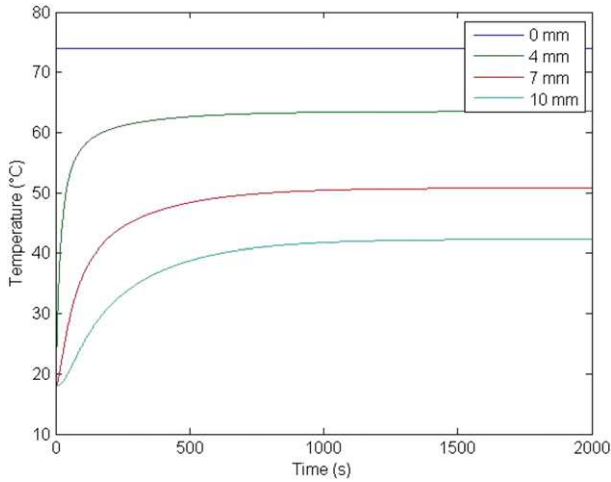

Fig. 8. Transient thermal response of silicone block.

The previous thermomechanical simulations are the first approach for getting knowledge of internal phenomenon of silicone gel. In further work, the mechanical FEM simulations in Figs. 9 and 10 will be used to validate of electric equivalent nodal models based on viscoelastic models in Figs. 3 and 4.

6. Conclusion

This work has demonstrated the interest of deeply studying silicone gel used in power module devices due to its thermomechanical behavior and possible effects on components inside of the module. Indeed, it has been shown that silicone gel may induce mechanical stresses inside of the power module. This has to be particularly investigated for new silicone gels adapted to high temperature operations for wide-gap semiconductor technologies that are more and more in used in high integrated power modules.

Moreover, it has been proved in this paper that thermal model based on nodal approximation may lead to a satisfying approximation of internal temperature of a silicone gel block.

Further work will deal with the development of thermal nodal models well adapted to complex geometry of real power modules. Moreover, a similar nodal model based on mechanical behavior of viscoelastic polymers has to be developed and the link between thermal and mechanical behaviors has to be formalized. A particular focus will be done on mechanical parameters that depend on stress and temperature.

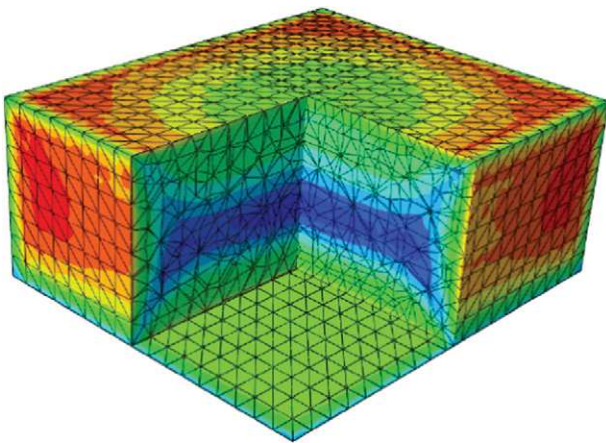

Fig. 9. Von Mises stress field in silicone gel block.

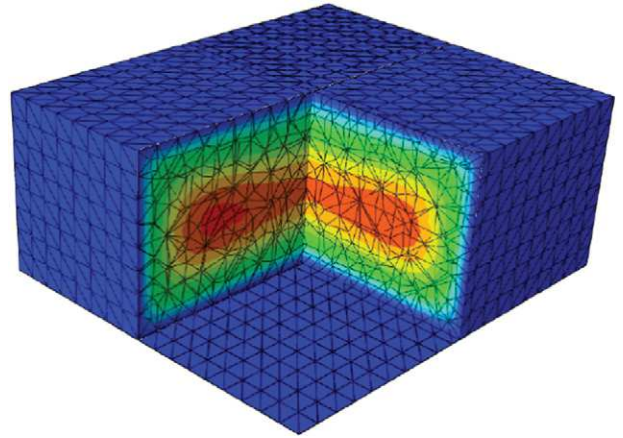

Fig. 10. Displacement field in silicone gel block.

Finally, this points will be linked with electrical sollicitation leading to heat source distribution and finally to thermal and mechanical (stress or displacements) fields inside of the power module.

Another point of interest lies in the simulation of thermal, stress and displacements along time. Indeed, life time of power modules is strongly affected by thermal and mechanical cyclings due to electrical sollicitations.

References

- [1] M. Ciappa, Selected failure mechanisms of modern power modules, *Microelectron. Reliab.* 42 (2002) 653–667.
- [2] T. Lebey, D. Malec, S. Dinulescu, V. Costan, F. Breit and E. Dutarde, "Partial discharges phenomenon in high voltage power modules", vol. 13, D. a. E. Insulation, Ed., IEEE, 2006, pp. 810–819.
- [3] N. Viviès, M. Haussener, H. Welemane, B. Trajin, P.E. Vidal, Characterization of an integrated buck converter using infrared thermography, *The 12th International Conference on Quantitative InfraRed Thermography (QIRT)*, 2014.
- [4] T. Thomas, K.-F. Becker, T. Braun, M. van Dijk, O. Wittler, K.-D. Lang, Assessment of high temperature reliability of molded smart power modules, *Electronics System-Integration Technology Conference (ESTC)*, 2014.
- [5] W.W. Sheng, R.P. Colino, *Power Electronic Modules: Design and Manufacture*, CRC Press, 2004.
- [6] B. Trajin, P.E. Vidal, J. Viven, *Electro-thermal model of an integrated buck converter*, *European Conference on Power Electronics and Applications (EPE)*, 2015.
- [7] M.G. Mario, R. Casu, G. Masera, G. Piccinini, M. Zamboni, Coupled electro-thermal modeling and optimization of clock networks, *Microelectron. J.* 34 (2003).
- [8] A. Malkin, A. Isayev, *Rheology: Concepts, Methods, and Applications*, ChemTec Publishing, 2006.
- [9] D.C. Karnopp, D.L. Margolis, R.C. Rosenberg, *System Dynamics: Modeling and Simulation of Mechatronic Systems*, 4th ed. Wiley, New-York, 2006.
- [10] J.G. Drobny, *Polymers for Electricity and Electronics: Materials, Properties, and Applications*, Wiley, New-York, 2012..