



**HAL**  
open science

## **IPIN 2018 - Ninth International Conference On Indoor Positioning And Indoor Navigation**

Valérie Renaudin, Aigul Khamitova, Miguel Ortiz

► **To cite this version:**

Valérie Renaudin, Aigul Khamitova, Miguel Ortiz. IPIN 2018 - Ninth International Conference On Indoor Positioning And Indoor Navigation. IFSTTAR, 183 p., 2018, 978-2-85782-748-1. hal-01920938

**HAL Id: hal-01920938**

**<https://hal.science/hal-01920938>**

Submitted on 30 Nov 2018

**HAL** is a multi-disciplinary open access archive for the deposit and dissemination of scientific research documents, whether they are published or not. The documents may come from teaching and research institutions in France or abroad, or from public or private research centers.

L'archive ouverte pluridisciplinaire **HAL**, est destinée au dépôt et à la diffusion de documents scientifiques de niveau recherche, publiés ou non, émanant des établissements d'enseignement et de recherche français ou étrangers, des laboratoires publics ou privés.



# IPIN 2018

NINTH INTERNATIONAL CONFERENCE ON  
INDOOR POSITIONING  
AND INDOOR NAVIGATION

SEPTEMBER 24-27, 2018, NANTES, FRANCE

# GUIDE



# IPIN 2018

NINTH INTERNATIONAL CONFERENCE ON  
INDOOR POSITIONING  
AND INDOOR NAVIGATION

SEPTEMBER 24-27, 2018, NANTES, FRANCE



# Editorial

**D**ear participants,  
we are glad to welcome you in Nantes for the 9th International Conference on Indoor Positioning and Indoor Navigation.

In the current state of development the intense advent of terrestrial positioning systems, the internet of things (IoT) and human sensor networks providing new navigation functionalities set a novel paradigm for indoor positioning and navigation solutions. In the environment, where the navigation technology has extended to the challenges of the ubiquitous mobility of persons and goods, finding indoor navigation solutions has become a significant subject for the research. Still an obvious and overall solution is not yet found. Since the 1<sup>st</sup> edition IPIN has become a forum of excellence reuniting the researchers and product developers in the field of indoor positioning and navigation. Assembling nearly 400 of participants every year, both from academia and industry, it displays an active international community working daily to find the most effective solutions. In the footsteps of our colleagues,

we will open the discussions on various scientific and industrial topics during this conference. Our acclaimed invited speakers will talk about the latest tendencies in the field of navigation and share their vision on the development of the industry during the keynote plenary sessions. The speakers of the tutorials will present in one lesson the basic terms of localization with a camera and will help you to make the first steps towards the understanding of raw GNSS data. You may also contribute to the success of the conference by presenting and exchanging your ideas during multiple parallel sessions.

Likewise to the previous editions, the IPIN2018 Technical Program Committee (TPC) called for 2 types of submissions: regular papers and works-in-progress. The regular papers presented during the plenary sessions of the conference will be submitted to the IEEE Xplore Digital Library. The authors of both types of papers will have the opportunity to send the extended versions of their contributions to IEEE

Transactions on Instrumentation and Measurement. The best papers will be recognized in the course of the conference. Besides, this year the authors may seize the opportunity to submit the extended versions of their articles to the journal Sensors' Special Issue. The Best Conference Paper may submit its extended version for free. Also in cooperation with the journal Sensors, sponsor of the contest, we'll award the Best PhD Student paper of IPIN2018.

The IPIN competition this year is organized in a particular and uncommon (at least to scientific experiments) place – Atlantis shopping center, where the participants should compete among ordinary shoppers of the mall. The center was thoroughly surveyed and more than 180 marks were located on the ground with a planimetric precision of 10 centimeters. These marks were used to define the competition tracks.

We hope that besides the conference auditoriums you will also find the time to visit the wonderful city of Nantes, the largest city in the Western France, based on the banks of the river Loire and situated

**« Welcome to  
IPIN 2018 ! »**

near the Atlantic coast. During your promenades in the city you will discover that Nantes is famous for its history, culture, industry, gastronomy and wine growing. Nantes suggests you to explore the multiple sides of its identity. Between the coast and the countryside, between French and Celtic vibes, from the home of dukes of Brittany to the center of shipbuilding yard, from the numerous vineyards of Muscadet wine of the Loire valley to a hometown of the famous Petit Beurre LU biscuits and the berlingot sweets, from its rich architectural heritage reflecting different eras to the large-scale creatures of Jules Verne's imaginary world, Nantes can offer you a great adventure.

Last but not least, we thank you for your contribution to IPIN2018. We hope you will enjoy your visit here and will spend some quality time.

September 2018  
Dr. Valérie Renaudin and Prof. Masanori Sugimoto  
Conference Co-Chairs

# Contents

8

## Topics

Ubiquitous geolocation technologies

Indoor location sharing in IoT context

Connected intelligent urban mobility

Special sessions

## Organizers & Committees

16

## Program

### Synthesized program

Have a look at the program and compose the itinerary of your choice. Presentations are synchronized between sessions.

### Detailed program

Monday, 24 September

Tuesday, 25 September

Wednesday, 26 September

Thursday, 27 September

This booklet was designed to help you keep track of all information and events of the conference and take notes of your ideas and impressions. Keep it with you and save your memories about your journey during this conference.

36

## Keynotes

40

## Tutorials

42

## Extract papers

44 Ubiquitous geolocation technologies

78 Indoor location sharing in IoT context

112 Connected intelligent urban mobility

148 Special sessions

156

## Posters

163

## Competition

For the 1<sup>st</sup> time in IPIN history, the competition is organized in the real-life environment - in the Atlantis shopping mall.

172

## Useful information

### Plans

### Acknowledgements

### Key players

# Topics

## Ubiquitous geolocation technologies

**In search of novel universal navigation solutions.** Geolocation technologies are expected to be accurate and to work everywhere including indoor spaces without complexity. The challenge is to develop technologies that are capable to recognize the environments and to provide seamless indoor/outdoor geolocation without accuracy loss. Irrespective of the solution, technologies have to be ubiquitous. In a context, where multiple sensors are deployed in the infrastructure, novel geolocation algorithms must also find their way to incorporate opportune measurements and tune the algorithms to the needs of final users.

## Connected intelligent urban mobility

**Developing navigation solutions to accompany the advent of new means of transportation.** Transport is seeking for green and cheap mobility solutions. This leads to novel transportation means, including autonomous vehicle, gyropodes, electric bicycle and other innovative transportation body. This introduces novel challenges. Gyropodes are used indoors or in deep urban canyons where geolocation technology is challenging. Autonomous vehicles / UAV are ready to enter the stage and appear on our streets and indoor facilities along with the non-autonomous vehicles. More precise geolocation solutions with high integrity level is necessary for the coexistence of diverse transportation bodies, in particular autonomous and non-autonomous. The challenge is to treat and develop geolocation instruments in the more “deep indoor” environment.

## Indoor location sharing in IoT context

**Everyone and everything are connected.** Nowadays persons and goods are circulating in the connected world. Most of the services are developing thanks to the connection to the Internet. Moreover, this trend depends on knowing the geographical coordinates of the persons and goods. With miniaturized connected objects, positioning and navigation algorithms must address deep indoor environment to support the development of IoT services. The challenge in this field is to ensure that the subjects and objects are localized accurately and continuously but taking into account the manufacturing issues, such as battery consumption, computation costs, pricing and other production constraints. The IoT world is a great opportunity for the indoor positioning and navigation community but the challenges to be met are really high.

## Special sessions

**This year IPIN welcomes 2 special sessions.** The 1<sup>st</sup> one is dedicated to *RSSI-based Direction Finding*. This session is meant to gather experts in the emerging field of RSS-based DOA. The 2<sup>nd</sup> one is dedicated to *A Survey on Indoor Localization Competitions*. This session will give an insight on indoor localization competitions by introducing overview of existing competitions and their characteristics made by invited competition organizers.



Find easily  
paper extracts  
classified in  
4 big themes  
(recognizable  
by color)

# Organizers & Committees

## Conference Co-Chairs

**Dr. Valérie Renaudin**  
GEOLOC Team, IFSTTAR, France

**Prof. Masanori Sugimoto**  
Hokkaido University, Department of Computer Science and Information Technology, Japan

## Publication committee

**Dr. Kyle O'Keefe**  
University of Calgary, Department of Geomatics Engineering, Canada

**Dr. Valérie Renaudin**  
GEOLOC Team, IFSTTAR, France

## Conference Treasurer

**Alexandra Richard**  
IFSTTAR, France

## Competition Track Chairs

**Miguel Ortiz**  
GEOLOC Team, IFSTTAR, France

**Joaquín Torres-Sospedra**  
Universitat Jaume I, Spain

## Steering Committee

**Rainer Mautz**  
Swiss Federal Railways, Switzerland

**Adriano Moreira**  
University of Minho, Portugal

**Binghao Li**  
University of New South Wales, Australia

**Philippe Canalda**  
Université de Franche-Comté, France

**Kyle O'Keefe**  
University of Calgary, Canada

**Hideo Makino**  
Niigata University, Japan

**Jesús Ureña**  
University of Alcalá, Spain

**Masanori Sugimoto**  
Hokkaido University, Japan

**Valérie Renaudin**  
IFSTTAR, France

## Local organising staff

**GEOLOC Team at IFSTTAR**  
The French Institute of Science and Technology for Transport, Development and Networks

**Mahdi Abid**  
GEOLOC Team, IFSTTAR, France

**Nicolas Antigny**  
GEOLOC Team, IFSTTAR, France

**Roger Chatagnon**  
IFSTTAR, France

**Élizabeth Colin**  
EFREI Paris, France

**Mary Douillard**  
IRSTV, France

**Isabelle Dussutour**  
ID4Car, France

**Fadoua Taia-Alaoui**  
GEOLOC Team, IFSTTAR, France

**Sylviane Jacquet**  
IFSTTAR, France

**Nathalie Juignet**  
IFSTTAR, France

**Aigul Khamitova**  
GEOLOC Team, IFSTTAR, France

**Viviane Le Manach**  
IFSTTAR, France

**Miguel Ortiz**  
GEOLOC Team, IFSTTAR, France

**Johan Perul**  
GEOLOC Team, IFSTTAR, France

**Céline Ragoïn**  
GEOLOC Team, IFSTTAR, France

**Alexandra Richard**  
IFSTTAR, France

**Valérie Renaudin**  
GEOLOC Team, IFSTTAR, France

**Gilles Le Roux**  
GEOLOC Team, IFSTTAR, France

**Cyrille Vandenheede-Belon**  
IFSTTAR, France

**Émilie Vidal**  
IFSTTAR, France

## Technical Program Committee Chairs

**Élizabeth Colin**  
EFREI Paris, France

**Miguel Ortiz**  
GEOLOC Team, IFSTTAR, France

## Technical Program Committee

**Ana Paula Afonso FC**  
University of Lisbon, Portugal

**Haris Afzal**  
RXNetworks

# Organizers & Committees

## **Teodoro Aguilera**

University of Extremadura, Spain

## **Joaquín Aparicio**

Agency for Marine-Earth Science  
Technology, Japan

## **Oumaya Baala**

Technical University of Belfort-  
Montbéliard, France

## **Paolo Barsocchi**

ISTI, Italy

## **Rafael Berkvens**

IDLab, University of Antwerp, Belgium

## **Michela Bertolotto**

University College Dublin, Ireland

## **David Bétaille**

IFSTTAR, France

## **Jorg Blankenbach**

RWTH Aachen University, Germany

## **Chris Bleakley**

University College Dublin, Ireland

## **Peter Brida**

University of Žilina, Slovakia

## **Alexandre Caminada**

Technical University of Belfort-  
Montbéliard, France

## **Philippe Canalda**

University of Franche-Comté, France

## **Sara Abou Chakra**

Université Libanaise, Liban

## **Stefano Chessa**

University of Pisa, Italy

## **Jussi Collin**

Technical University Tampere, Finland

## **Christophe Combettes**

French-German Research Institute of  
Saint-Louis, France

## **Mário Costa**

Huawei R&D, Helsinki, Finland

## **James Curran**

European Space Agency, EU

## **Alessio Deangelis**

University of Perugia, Italy

## **Luca De Nardis**

Sapienza Università Di Roma, Italy

## **Benoît Denis**

CEA, LETI, France

## **Estefania Diaz-Ropero**

German Aerospace Center (DLR),  
Germany

## **Antonio Duarte Costa**

University of Minho, Portugal

## **Daniele Fontanelli**

University of Trento, Italy

## **Sergio Fortes**

Universidad de Malaga, Spain

## **Hassen Fourati**

Gipsa-Lab, France

## **Norbert Franke**

Fraunhofer IIS, Germany

## **Frédéric Événou**

Orange, France

## **Salvatore Gaglione**

University of Naples, Italy

## **Enrique Garcian**

University College Cork, Ireland

## **Juan Jesús García**

University of Alcalá, Spain

## **Alain Geiger**

IGP, ETH Zurich, Switzerland

## **Robert Guinness**

Finnish Geodetic Institute, Finland

## **Jose Guivant**

University of New South Wales, Australia

## **Dongsoo Han**

KAIST, South Korea

## **Zhe He**

Appropolis Inc, Canada

## **Álvaro Hernández Alonso**

University of Alcalá, Spain

## **Sverre Holm**

University of Oslo, Norway

## **Seung-Hoon Hwang**

Dongguk University, South Korea

## **Fernando J. Álvarez Franco**

University of Extremadura, Spain

## **Sampath Jayalath**

University of Cape Town, South Africa

## **Susanna Kaiser**

DLR, Germany

## **Hassan Karimi**

University of Pittsburgh, USA

## **Michel Kasser**

ENSG Paris, France

## **Nobuo Kawaguchi**

Nagoya University, Japan

## **Martti Kirkko-Jaakkola**

Finish Geodetic Institute, Finland

## **Stefan Knauth**

University of Stuttgart, Germany

## **Naohiko Kohtake**

Keio University, Japan

## **Seung-Hyun Kong**

KAIST, South Korea

## **Quentin Ladetto**

Technology Foresight, Switzerland

## **Christos Laoudias**

Huawei R&D, Dublin, Ireland

## **Binghao Li**

University of New South Wales, Australia

## **Ki-Joune Li**

Pusan National University, South Korea

## **Simona Lohan**

Tampere University of Technology,  
Finland

## **David Macii**

University of Trento, Italy

## **Hideo Makino**

Niigata University, Japan

## **Catherine Marechal**

EFREI, France

## **Ernesto Martin**

University of Alcalá, Spain



# Organizers & Committees

## **Rainer Mautz**

Swiss Federal Railways, Switzerland

## **Filipe Meneses**

University of Minho, Portugal

## **Bertrand Merminod**

EPFL, Switzerland

## **Raúl Montoliu**

Jaume I University, Spain

## **Adriano Moreira**

University of Minho, Portugal

## **Alain Moretto**

EFREI, France

## **Aiden Morrison**

SINTEF Digital, Norway

## **Christopher Mutschler**

Fraunhofer IIS, Germany

## **Masanari Nakamura**

Mitsubishi Electric Corp., Japan

## **Phong Nguyen**

Hitachi Ltd., Japan

## **Maria João Nicolau**

University of Minho, Portugal

## **Aboelmagd Noureldin**

Royal Military College of Canada,  
Canada

## **Jari Nurmi**

Technical University Tampere, Finland

## **Washington Ochieng**

Imperial College London,  
United Kingdom

## **Kyle O'Keefe**

University of Calgary, Canada

## **Miguel Ortiz**

IFSTTAR, France

## **Nicolas Paparoditis**

École Nationale des Sciences  
Géographiques, France

## **Chan Gook Park**

Seoul National University, South Korea

## **Ling Pei**

Shanghai Jiao Tong University, China

## **Herbert Peremans**

University of Antwerpen, Belgium

## **Antoni Pérez Navarro**

Open University of Catalonia, Spain

## **Robert Piché**

Tampere University of technology,  
Finland

## **Ivana Podnar Žarko**

University of Zagreb, Croatia

## **Francesco Potorti**

ISTI-CNR Institute, Pisa, Italy

## **Antonio R. Jiménez Ruiz**

Spanish National Research Council  
(CSIC), Spain

## **Cyril Ray**

École Navale, France

## **Milan Redžić**

Huawei R&D, Dublin, Ireland

## **Valérie Renaudin**

IFSTTAR, France

## **Günther Retscher**

TU Wien, Austria

## **Slobodan Ribaric**

University of Zagreb, Croatia

## **Patrick Robertson**

German Aerospace Center (DLR),  
Germany

## **Laura Ruotsalainen**

Finnish Geodetic Institute, Finland

## **David Salido Monzu**

ETH Zurich, Switzerland

## **Nel Samama**

Telecom Paris Sud, France

## **Fernando Seco Granja**

Spanish National Research  
Council (CSIC), Spain

## **Myriam Servières**

École Centrale Nantes, France

## **Yoan Shin**

Soongsil University, South Korea

## **Isaac Skog**

KTH Royal Institute of Technology,  
Sweden

## **Francois Spies**

University of Franche-Comté, France

## **Harald Sternberg**

HCU Hamburg, Germany

## **Masanori Sugimoto**

Hokkaido University, Japan

## **Melania Susi**

Tierra S.p.A., Italy

## **Paul Thevenon**

ENAC, France

## **Michel Thibaud**

Grenoble Alpes University, France

## **Joaquín Torres Sospedra**

Jaume I University, Spain

## **Antonios Tsourdos**

Cranfield University, United Kingdom

## **Hideaki Uchiyama**

Kyushu University, Japan

## **Bernard Uguen**

Rennes 1 University, France

## **Jesús Ureña**

University of Alcalá, Spain

## **Jérôme Verdun**

ESGT, France

## **Alexandre Vervisch-Picois**

Telecom Sud Paris,  
Institut Mines Telecom, France

## **Dario Vieira**

EFREI, France

## **José Vieira**

University of Aveiro, Portugal

## **Jinling Wang**

University of New South Wales, Australia

## **Martin Werner**

DLR, Germany

## **Andreas Wieser**

ETH Zurich, Switzerland

## **Lauri Wirola**

HERE, Finland

**Have a look at  
the program  
and compose  
the itinerary  
of your choice.  
Presentations  
are synchronized  
between sessions.**



1.

**Program**

# Synthesized program



Monday,  
**24**  
September

Tuesday,  
**25**  
September

Wednesday,  
**26**  
September

Thursday,  
**27**  
September



<b>Tutorial</b> IF YOU TELL ME WHAT YOU LOOK AT, I COULD TELL YOU WHERE YOU ARE	<b>Tutorial</b> USING GNSS RAW MEASUREMENTS ON ANDROID DEVICES	<b>Workshop</b> STANDARDS FOR INDOOR MAPS
<b>Opening Session</b>		
<b>Keynote</b> ACCELERATING FUTURE GROWTH OF A SLOW STARTING INDOOR POSITIONING MARKET		
<b>Parallel Session</b> A1 B1 C1		
<b>Icebreaker</b>		

<b>Keynote</b> TECHNOLOGY TRENDS IN GEOLOCATION			<b>Exhibition</b>
<b>Parallel Session</b> A2 B2 C2	<b>SP</b> 1		
<b>Lunch</b>			
<b>Parallel Session</b> A3 B3 C3			
<b>Poster Session</b>			
<b>Parallel Session</b> A4 B4 C4			

<b>Keynote</b> INERTIAL MEMS SENSORS ARE BECOMING 3D AND ATOMICALLY PRECISE			<b>Exhibition</b>
<b>Parallel Session</b> A5 B5 C5	<b>SP</b> 2		
<b>Lunch</b>			
<b>Parallel Session</b> A6 B6 C6	<b>TPC Meeting</b>		
<b>Parallel Session</b> A7 B7 C7			
<b>Gala dinner</b>			

<b>Keynote</b> VISION OF NAVIGATION
<b>Best papers and competition presentations</b>
<b>Award ceremony</b>
<b>Closing Session</b>

# Detailed program

## Monday, 24 September

09:00	<b>REGISTRATION</b> <i>Mezzanine</i>
10:00-12:00	<b>TUTORIALS</b> <b>TUTORIAL 1</b> <i>Room KL</i> <b>If you tell me what you look at, I could tell you where you are</b> <i>Myriam Servières</i> <b>TUTORIAL 2</b> <i>Room GH</i> <b>Using GNSS Raw Measurements on Android Devices</b> <i>Moisés Navarro-Gallardo, Gaetano Galluzzo, Martin Šunkevič</i>
10:00-13:00	<b>IPIN/ISC WORKSHOP</b> open for public <i>Room MN</i> <b>Standards for indoor maps</b> <i>Prof. Ki-Joune Li</i>
13:00	<b>REGISTRATION</b> <i>Mezzanine</i> <b>BRIEFING OF THE SPEAKERS OF THE DAY</b> <i>Room I</i>
14:00-14:30	<b>OPENING CEREMONY</b> <i>Auditorium 450</i>
14:30-15:30	<b>KEYNOTE SESSION</b> <i>Auditorium 450</i> <b>Accelerating Future Growth of a Slow Starting Indoor Positioning Market</b> <i>David Vissière</i>
15:30 - 15:50	<b>COFFEE BREAK</b> <i>Mezzanine</i>

15:50 - 17:20

### PARALLEL SESSIONS

#### **SESSION A1 - Applications of Location Awareness & Context Detection** *Room GH*

213184 - Continuous Pose Estimation for Urban Pedestrian Mobility Applications on Smart-handheld Devices

*Nicolas Antigny, Myriam Servières, Valérie Renaudin*

213249 - Error Analysis of ZUPT-Aided Pedestrian Inertial Navigation

*Yusheng Wang, Andrei Chernyshoff, Andrei M. Shkel*

212143 - Copernicus: A Robust AI-Centric Indoor Positioning System

*Yiannis Gkoufas, Kostas Katrinis*

213430 - Crowd-Sourcing RF Profiles for Store Visit Confirmation using SLAM

*Firas Aleshly, Chai Wennan, Juri Arief, Zampella Francisco*

#### **SESSION B1 - Signal Strength Based Methods, Fingerprinting** *Auditorium 450*

213073 - CDM: Compound dissimilarity measure and an application to fingerprinting-based positioning

*Caifa Zhou, Andreas Wieser*

212700 - DelFin: A Deep Learning based CSI Fingerprinting Indoor Localization in IoT context

*Brieuc Berruet, Oumaya Baala, Alexandre Caminada, Valéry Guillet*

210946 - A new methodology for long-term maintenance of WiFi fingerprinting radio maps

*Raúl Montoliu, Emilio Sansano, Oscar Belmonte,*

*Joaquín Torres-Sospedra*

212549 - Signal Fingerprint Anomaly Detection for Probabilistic Indoor Positioning

*Ran Guan, Robert Harle*

ALTERNATE:

212712 - WiFi Fingerprinting Localization for Intelligent Vehicles in Car Park

*Dinh Van Nguyen, Raoul De Charette, Trung-Kien Dao, Éric Castelli, Fawzi Nashashibi*

**Session C1 - Localization, Algorithms for Wireless Sensor Networks**

*Room KL*

212122 - Recursive Bayesian Filters for RSS-based Device-free Localization and Tracking

*Ossi Kaltiokallio, Roland Hostettler, Neal Patwari, Riku Jäntti*

212292 - Specific Study of Delta Range Positioning

*Alexandre Vervisch, Nel Samama*

212994 - Information Theoretic Framework for the Optimization of UWB Localization Systems

*Anthony Schenck, Edwin Walsh, Jonas Reijniers, Ted Ooijevaar, Gatot Yudanto, Erik Hostens, Walter Daems, Jan Steckel*

213066 - LocURa: A New Localisation and UWB-Based Ranging Testbed for the Internet of Things

*Adrien van den Bossche, Réjane Dalce, Nicolas Gonzalez, Thierry Val*

**17:40 - 18:00** **EXHIBITION OPENING** *Mezzanine*

**18:00 - 19:00** **ICEBREAKER** *Mezzanine*

**19:00 - 20:00** **CULTURAL PERFORMANCE** *Mezzanine*



## Tuesday, 25 September

**08:15** **REGISTRATION** *Mezzanine*

**BRIEFING OF THE SPEAKERS OF THE DAY** *Room I*

**9:00-10:00** **KEYNOTE SESSION** *Auditorium 450*

**Technology Trends in Geolocation**

*Justyna Redelkiewicz*

**10:00 - 10:20** **COFFEE BREAK** *Mezzanine*

**10:00 - 18:00** **EXHIBITION** *Mezzanine*

**10:20 - 12:20** **PARALLEL SESSIONS**

**SESSION A2 - Wearables and Multi-Sensors Systems** *Room GH*

213201 - Comparing Heading Estimates from Multiple Wearable Inertial and Magnetic Sensors Mounted on Lower Limbs

*Chandra Tjhai, Kyle O'Keefe*

212531 - Intelligent Urban Mobility: Pedestrian and Bicycle Seamless Navigation

*Estefania Munoz Diaz, Fabian de Ponte Müller, Eduardo Perez Gonzalez*

212925 - Motion Context Adaptive Fusion of Inertial and Visual Pedestrian Navigation

*Jesper Rantanen, Maija Mäkelä, Laura Ruotsalainen, Martti Kirkko-Jaakkola*

212971 - Fast Linear Attitude Estimation and Angular Rate Generation

*Zeliang Zhang, Zebo Zhou, Jin Wu, Shuang Du, Hassen Fourati*

211922 - A Pedestrian Positioning System integrated into a Cyber-Physical System for Emergency Responders' Monitoring

*André G. Ferreira, Duarte Fernandes, Joao L. Monteiro, Andre P. Catarino, Ana M. Rocha*

ALTERNATE:

212314 - 3D Loose-Coupled Fusion of Inertial Sensors for Pedestrian Localization

*Dina Bousdar Ahmed, Estefania Munoz Diaz*

## **SESSION B2 - Robotics and UAV Auditorium 450**

212594 - SAR-based Indoor Localization of UHF-RFID Tags via Mobile Robot

*Andrea Motroni, Paolo Nepa, Valerio Magnago, Alice Buffi, Bernardo Tellini, Daniele Fontanelli, David Macii*

212875 - Vision-Based Indoor Positioning of a Robotic Vehicle With a Floorplan

*John Noonan, Hector Rotstein, Amir Geva, Ehud Rivlin*

212918 - Lightweight Line Features for Indoor Camera Pose Estimation

*Amir Geva, Hector Rotstein*

211103 - Real-Time Localization and Tracking using Visible Light Communication

*Márk Rátosi, Gyula Simon*

212196 - EIRIS - An Extended Proposition using Modified Occupancy Grid Map and Proper Seeding

*Arup Kumar Sadhu, Ranjan Dasgupta, P Balamuralidhar*

ALTERNATE:

212333 - Model based drift-free localization for multirotors

*Mohit Ludhiyani, Vishvendra Rustagi, Arnab Sinha, Ranjan Dasgupta*

## **SESSION C2 - Hybrid IMU Pedestrian Navigation & Foot Mounted Navigation Room 200**

212523 - LSTM-based Zero-Velocity Detection for Robust Inertial Navigation

*Brandon Wagstaff, Jonathan Kelly*

212839 - Elevator and Escalator Classification for Precise Indoor Localization

*Nikolai Kronenwett, Shaochen Qian, Karsten Mueller, Gert F. Trommer*

212908 - Corrective Track Form Matching for Real-Time Pedestrian Navigation

*Pekka Peltola, Antonio Jimenez Ruiz, Fernando Seco, Terry Moore, Aled Catherall*

212071 - An Indoor Positioning and Navigation Application for Visually Impaired People using Public Transport

*Thomas Moder, Clemens Reitbauer, Roman Wilfinger, Karin Wisiol, Manfred Wieser*

209530 - Pedestrian Dead Reckoning with Turn-based Correction

*Zhao Yonghao, Wai-Choong Wong, Hari Krishna Garg, Tianyi Feng*

ALTERNATE:

213087 - Building individual inertial signals models to estimate PDR walking direction with smartphone sensors

*Johan Perul, Valérie Renaudin*

## **SESSION SP1 - RSSI Based Direction Finding Room KL**

213016 - Dynamic Beam Selection for Beam-RSRP Based Direction Finding in mmW 5G Networks

*Elizaveta Rastorgueva-Foi, Mário Costa, Mike Koivisto, Kari Leppänen, Mikko Valkama*

212342 - RSS-based DoA Estimation Using ESPAR Antenna Radiation Patterns Spline Interpolation

*Mateusz Groth, Krzysztof Nyka, Lukasz Kulas*

212022 - Experimental Performance Evaluation of Outdoor TDoA and RSS Positioning in a Public LoRa Network

*David Plets, Nico Podevijn, Jens Trogh, Luc Martens, Wout Joseph*

212722 - Bluetooth-based Indoor Positioning through ToF and RSSI Data Fusion

*Davide Giovanelli, Elisabetta Farella, Daniele Fontanelli, David Macii*

212809 - Super-Resolution in RSS-based Direction-of-Arrival Estimation

*Thorsten Nowak, Markus Hartmann, Joern Thielecke, Niels Hadaschik, Christopher Mutschler*

**12:20 - 14:00**

**LUNCH** Area R2 & Mezzanine

**14:00 - 15:30**

## **PARALLEL SESSIONS**

### **SESSION A3 - TOF, TDOA based Localization Room GH**

212651 - SMILe - Simulator for Methods of Indoor Localization

*Tomasz Jankowski, Maciej Nikodem*

213141 - Recurrent Neural Networks on Drifting Time-of-Flight Measurements

*Tobias Feigl, Thorsten Nowak, Michael Philippsen, Thorsten Edelhäuser, Christopher Mutschler*

211353 - Improved Time of Arrival Measurement Model for Non-Convex Optimization with Noisy Data

*Juri Sidorenko, Volker Schatz, Norbert Scherer-Negenborn, Michael Arens, Urs Hugentobler*

213405 - Smartphone Localization using Active-Passive Acoustic Sensing

*Hiroaki Murakami, Masanari Nakamura, Shoma Yamasaki, Hiromichi Hashizume, Masanori Sugimoto*

ALTERNATE:

213181 - Evaluation of range error calibration models for indoor UWB positioning applications

*Harris Perakis, Vassilis Gikas*

### **SESSION B3 - Signal Strength Based Methods, Fingerprinting**

*Auditorium 450*

213233 - A Bayesian Approach to Dealing with Device Heterogeneity in an Indoor Positioning System

*Kyle Davies, Jonathan Shapiro, Ian Jones*

213049 - Neural Network Based Radio Fingerprint Similarity Measure

*Boxian Dong, Thomas Burgess, Hans-Berndt Heuner, Susanne Fercher*

213240 - Unsupervised Deep Feature Learning to Reduce the Collection of Fingerprints for Indoor Localization using Deep Belief Networks

*Duc Le, Nirvana Meratnia, Paul Havinga*

212984 - Passive Wi-Fi Fingerprinting Method

*Jaewon Kim, Dongsoo Han*

### **SESSION C3 - Human Motion Monitoring** *Room 200*

213376 - A Simulation-based Approach to Generate Walking Gait Accelerations for Pedestrian Navigation Solutions

*Mahdi Abid, Valérie Renaudin, Thomas Robert, Yannick Aoustin, Éric Le Carpentier*

213038 - Classifying Elevators and Escalators in 3D Pedestrian Indoor Navigation using Foot-Mounted Sensors

*Christopher Lang, Susanna Kaiser*

213348 - A Novel Step Detection and Step Length Estimation Algorithm for Hand-held Smartphones

*Nicolò Strozzi, Federico Parisi, Gianluigi Ferrari*

212681 - Step Length Estimation using UWB Technology: A Preliminary Evaluation

*Luis Enrique Díez, Alfonso Bahillo, Timothy Otim, Jon Otegui*

**15:30 - 15:50**

**COFFEE BREAK** *Mezzanine*

**15:30 - 16:30**

**POSTER SESSION** *Area R2*

(See list of the posters on the p.156)

**16:30 - 18:00**

**PARALLEL SESSIONS**

### **SESSION A4 - Frameworks for Hybrid Positioning** *Room GH*

212664 - Gravity Direction Estimation and Heading Determination for Pedestrian Navigation

*Adi Manos, Itzik Klein, Tamir Hazan*

212431 - Location of Persons using Binary-sensors and BLE for Ambient Assitive Living

*Antonio Jimenez Ruiz, Fernando Seco Granja, Pekka Peltola, Macarena Espinilla Estevez*

213271 - A loosely coupled cooperative localization augmentation to improve human geolocation in indoor environments

*Jianan Zhu, Solmaz Kia*

209622 - Smartphone-based user positioning in a multiple-user context with Wi-Fi and Bluetooth

*Viet-Cuong Ta, Dominique Vaufreydaz, Trung-Kien Dao, Éric Castelli*

ALTERNATE:

210717 - Kalman-type filters and smoothers for pedestrian dead reckoning

*Pavel Ivanov, Matti Raitoharju, Robert Piché*

### **SESSION B4 - Magnetic Localization** *Auditorium 450*

213245 - Experimental Evaluation of the Planar Assumption in Magnetic Positioning

*David Hanley, Xiangyuan Zhang, Augusto Dantas de Oliveira, Daniel Steinberg, Timothy Bretl*

213424 - Rotation-Invariant Magnetic Features for Inertial Indoor-Localization

*Konstantin Klipp, Helge Rosé, Jonas Willaredt, Oliver Sawade, Ilja Radusch*

213072 - Magnetic field as a characterization of wide and narrow spaces in a real challenging scenario using Dynamic Time Warping

*Antoni Pérez Navarro, Raúl Montoliu, Joaquín Torres-Sospedra, Jordi Conesa*

212360 - Crowdsourcing-based Magnetic Map Generation for Indoor Localization

*Akin Ayanoglu, Ben Eitel, Daniel M. Schneider*

ALTERNATE:

209918 - Improved Indoor Geomagnetic Field Fingerprinting for Smartwatch Localization Using Deep Learning

*Fahad Al-homayani, Mohammad Mahoor*

**SESSION C4 - Optical Systems** Room 200

212013 - Indoor Positioning using OFDM-based Visible Light Communications Systems

*Birendra Ghimire, Jochen Seitz, Christopher Mutschler*

213409 - Indoor Positioning Using Reflected Light and a Video Camera

*Shota Shimada, Hiromichi Hashizume, Masanori Sugimoto*

212316 - Simplified calibration process for a PSD-based optical IPS

*David Rodriguez-Navarro, Jose Luis Lázaro-Galilea, Felipe Espinosa, Álvaro De-La-Llana-Calvo, Carlos Santos*

213254 - QADA-plus: a novel two-stage receiver for visible light positioning

*Stefanie Cincotta, Cuiwei He, Adrian Neild, Jean Armstrong*

ALTERNATE:

212320 - Unmodulated Visible Light Positioning using the Iterated Extended Kalman Filter

*Robin Amsters, Eric Demeester, Nobby Stevens, Peter Slaets*



## Wednesday, 26 September

**08:15** REGISTRATION Mezzanine

**BRIEFING OF THE SPEAKERS OF THE DAY** Room 1

**09:00 - 10:00** KEYNOTE SESSION Auditorium 450

**Inertial MEMS Sensors are becoming 3D and atomically precise**  
*Prof. Andrei M. Shkel*

**10:00 - 10:20** COFFEE BREAK Mezzanine

**10:00 - 17:20** EXHIBITION Mezzanine

**10:20 - 12:20** PARALLEL SESSIONS

**SESSION A5 - Mapping, SLAM** Room GH

212504 - FastGraph - Organic 3D Graph for Unsupervised Location and Mapping

*Cristiano Pendão, Adriano Moreira*

212127 - Accurate Fiducial Mapping For Pose Estimation Using Manifold Optimization

*Xiao Hu*

213391 - Registration and merging maps with uncertainties

*Martin Larsson, Kalle Åström, Magnus Oskarsson*

212677 - MOMA: Visual Mobile Marker Odometry

*Raul Acuna, Zaijuan Li, Volker Willert*

213228 - A Radio-Inertial Localization and Tracking System with BLE Beacons Prior Maps

*Maani Ghaffari Jadidi, Mitesh Patel, Jaime Valls Miro, Gamini Dissanayake, Jacob Biehl, Andreas Girsensohn*

**SESSION B5 - Signal Strength Based Methods, Fingerprinting**

Auditorium 450

212343 - Characterising the Alteration in the AP Distribution with the RSS Distance and the Position Estimates

*Joaquín Torres-Sospedra, Philipp Richter, Germán Martín Mendoza-Silva, Elena Simona Lohan, Joaquín Huerta*



213423 - RSS-based DOA / DOD Estimation Using Bluetooth Signal and Its Application For Indoor Tracking

*Naoki Honma, Ryota Tazawa, Atsushi Miura, Yusuke Sugawara, Hiroto Minamizawa*

213148 - A Method of Radio Map Construction based on Crowdsourcing and Interpolation for Wi-Fi Positioning System

*Jingxue Bi, Yunjia Wang, Hongji Cao, Hongxia Qi, Keqiang Liu, Shenglei Xu*

213357 - Response Adaptive Modelling for Reducing the Storage and Computation of RSS-based VLP

*Sander Bastiaens, David Plets, Luc Martens, Wout Joseph*

212728 - Outdoor Fingerprinting Localization using Sigfox

*Thomas Janssen, Michiel Aernouts, Rafael Berkvens, Maarten Weyn*

#### **SESSION C5 - Indoor Spatial Data Modelling & Indoor Mobile Mapping**

*Room 200*

212667 - GoIn - An Accurate 3D InDoor Navigation Framework for Mobile Devices

*Vlad Landa, Boaz Ben-Moshe, Nir Shvalb, Shlomi Hacohen*

213207 - Geometric Constraint Model and Mobility Graphs for Building Utilization Intelligence

*Burgess Thomas, Metzler Barbara, Andreas Ettlinger, Hans-Berndt Neuner*

198883 - VLF magnetic positioning in multistory parking garages

*Maxim Ralchenko, Mike Roper*

212027 - Convolutional Neural Networks for Position Estimation in TDoA-based Locating Systems

*Arne Niitsoo, Thorsten Edelhäuser, Christopher Mutschler*

212042 - Multi-Robot Mapping for Optically Guided Vehicles

*Preity Gupta, Jana Jost, Benjamin Bordihn*

Alternate:

212707 - RSS-based Map Construction for Indoor Localization

*Tian Sun, Wen Fu, Ao Peng, Lingxiang Zheng, Biyu Tang*

#### **SESSION SP2 - A Survey on Indoor Localization Competitions**

*Room KL*

Onsite Visual SLAM Evaluation

*Prof. Hideaki Uchiyama (Kyushu University, Japan) (Video presentation)*

Performance Evaluation of Indoor Positioning and Navigation Services during PyeongChang 2018 Winter Olympic Games by using IPIN competition setup

*Dr. Soyeon Lee (ETRI, South Korea)*

NIST Indoor 3D Challenge

*Mr. Jeb Benson (NIST, USA)*

PerfLoc Prize Competition for Development of Smartphone Indoor Localization Applications

*Dr. Nader Moayeri (NIST, USA)*

213242 - PerfLoc (Part 2): Performance Evaluation of the Smartphone Indoor Localization Apps

*Nader Moayeri, Chang Li, Lu Shi*

212811 - Review of PDR Challenge in Warehouse Picking and Advancing to xDR Challenge

*Ryosuke Ichikari, Ryo Shimomura, Masakatsu Kourogi, Takashi Okuma, Takeshi Kurata*

The result of xDR Challenge for Warehouse Operations 2018

*Dr. Ryosuke Ichikari (AIST, Japan)*

Closing: Brief Survey on Indoor Localization Competitions

**12:20 - 14:00**

**LUNCH** *Area R2 & Mezzanine*

**14:00 - 15:30**

#### **PARALLEL SESSIONS**

##### **SESSION A6 - TOF, TDOA based Localization** *Room GH*

213143 - Supervised Learning for Yaw Orientation Estimation

*Tobias Feigl, Christopher Mutschler, Michael Philippsen*

211557 - Multiuser Positioning with Particle Swarm Optimization in 3GPP Outdoor Scenarios

*Zhenyu Shi, Bin Hu, Yi Wang*

212377 - Comparison of Zadoff-Chu Encoded Modulation Schemes in an Ultrasonic Local Positioning System

*Santiago Murano, Carmen Perez-Rubio, Chris Bleakley, Jesús Ureña, Carlos Marziani*

212403 - NLOS Detection and Mitigation in Differential Localization Topologies based on UWB Devices

*Reza Zandian, Ulf Witkowski*

##### **SESSION B6 - Ultrasound Systems** *Auditorium 450*

213123 - Passive Acoustic Sound Source Tracking in 3D Using Distributed Microphone Arrays

*Erik Verreycken, Walter Daems, Jan Steckel*

212856 - Android application for indoor location using sensor fusion: ultrasounds and inertial devices

*Sergio Pérez, David Gualda, María del Carmen Pérez, José Manuel Villadangos, Jesús Ureña, Rubén Cervigón*

212867 - Robust Localization of Mobile Robot in Reverberant Rooms Using Acoustic Beacons with Iterative Bayesian Filtering

*Satoki Ogiso, Koichi Mizutani, Naoto Wakatsuki, Tadashi Ebihara*

212913 - Synchronization-free and Low Power TDOA for Radio Based Indoor Positioning

*Maximilian von Tschirschnitz, Marcel Wagner*

ALTERNATE:

210185 - Moving object tracking based on high precision opto-acoustic BPSK-CDMA distance measurement

*Dominik Esslinger, Philipp Rapp, Oliver Sawodny, Cristina Tarín*

#### **SESSION C6 - Localization, Algorithms for Wireless Sensor Networks**

*Room 200*

211990 - Accurate and Precise Distance Estimation from Phase-based Ranging Data

*Yannic Schröder, Dennis Reimers, Lars Wolf*

212923 - Experimental Evaluation of a Single Anchor Multipath Assisted Indoor Angle of Arrival Localization System in the 2.4 GHz and 5 GHz Band

*Stijn Wielandt, Bart Thoen, Lieven De Strycker*

213028 - A Computationally Efficient Method for Direction Finding with Known Transmit Sequence

*Ziming Zhu, Mohammad Bocus*

213037 - Sundew: Design and Evaluation of a Model-based Device-free Localization System

*Marco Cimdins, Mathias Pelka, Horst Hellbrück*

ALTERNATE:

213247 - Proposal for IMES transmitters using Location Information Code

*Takamasa Kawaguchi, Makoto Tanikawara, Kenjiro Fujii, Nobuaki Kubo*

**14:00 - 15:30**

**IPIN/TPC MEETING** *Room KL*

**15:30 - 15:50**

**COFFEE BREAK** *Mezzanine*

**15:50 - 17:20**

**PARALLEL SESSIONS**

#### **Session A7 - Benchmarking, technology assessment and standardization** *Room GH*

212900 - Evaluation of indoor localisation systems: comments on the ISO/IEC 18305 standard

*Francesco Potorti, Antonino Crivello, Paolo Barsocchi, Filippo Palumbo*

212467 - Evaluation Criteria for Inside-Out Indoor Positioning Systems based on Machine Learning

*Christoffer Löffler, Sascha Riechel, Janina Fischer, Christopher Mutschler*

213200 - An Analytical Study of Time of Flight Error Estimation in Two-Way Ranging Methods

*Cung Lian Sang, Michael Adams, Timm Hörmann, Marc Hesse, Mario Porrmann, Ulrich Rückert*

212331 - Characterization of Multipath Effects in Indoor Positioning Systems Based on Infrared Signals

*Álvaro De-La-Llana-Calvo, Jose Luis Lázaro-Galilea, Alfredo Gardel-Vicente, David Rodriguez-Navarro, Ignacio Bravo-Muñoz*

ALTERNATE:

212286 - Distributed Coordination, Transportation & Localisation in Industry 4.0

*Ruben Van Parys, Maarten Verbandt, Marcus Kotzé, Peter Coppens, Jan Swevers, Herman Bruyninckx, Johan Philips, Goele Pipeleers*

#### **SESSION B7 - UWB (Ultra WideBand)** *Auditorium 450*

208400 - UWB Ranging for Rapid Movements

*Tanguy Risset, Claire Goursaud, Xavier Brun, Kevin Marquet, Fabrice Meyer*

213256 - Assessing a UWB RTLS as a Means for Rapid WLAN Radio Map Generation

*Sharareh Naghdi, Chandra Tjhai, Kyle O'Keefe*

212401 - Implementation Challenges of Synchronisation of UWB Nodes in TDoA Structures

*Reza Zandian, Ulf Witkowski*

209646 - A Real-Time UWB Multi-Channel Indoor Positioning System for Industrial Scenarios

*Guido Schroeer*

### **SESSION C7 - Localization, Algorithms for Wireless Sensor Networks**

*Room 200*

213191 - Fingerprinting Method for Acoustic Localization using Low-Profile Microphone Arrays

*Bart Thoen, Stijn Wielandt, Lieven De Strycker*

212960 - A review of multidimensional scaling techniques for RSS-based WSN localization

*Fernando Seco, Antonio Ramón Jiménez Ruiz, Pekka Pelotola*

213394 - Convex Polygon Position Method for Homogeneous Optical Wireless Networks

*Fabian Seguel, Nicolas Krommenacker, Patrick Charpentier, Vincent Bombardier, Ismael Soto*

209830 - Fusing Map Information with a Probabilistic Sensor Model for Indoor Localization using RF Beacons

*Mitesh Patel, Andreas Girgensohn, Jacob Biehl*

ALTERNATE:

211918 - Performance Comparison of RSS Algorithms for Indoor Localisation in Large Open Environments

*Nico Podevijn, David Plets, Jens Trogh, Abdulkadir Karaagac, Jetmir Haxhibeqiri, Jeroen Hoebeke, Luc Martens, Pieter Suanet, Wout Joseph*

**19:30**

**GALA DINNER** *Machines de l'Île*

Parc des Chantiers, Boulevard Léon Bureau (see map on the p.180)

## Thursday, 27 September

**08:30** | **REGISTRATION** *Mezzanine*

**09:00 - 10:00** | **KEYNOTE SESSION** *Auditorium 450*

**Vision of Navigation**

*Dr. Laura Ruotsalainen*

**10:00 - 10:40** | **BEST PAPERS PRESENTATIONS** *Auditorium 450*

**10:40 - 11:00** | **COFFEE BREAK** *Mezzanine*

**11:00 - 12:00** | **COMPETITION PRESENTATIONS** *Auditorium 450*

**12:00 - 13:00** | **AWARD CEREMONY** *Auditorium 450*

**13:00 - 13:30** | **CLOSING CEREMONY AND IPIN2019 PRESENTATION** *Auditorium 450*



**Award  
ceremony  
& gala**

# Keynotes



## ACCELERATING FUTURE GROWTH OF A SLOW STARTING INDOOR POSITIONING MARKET

As co-founder in 2008 and current CEO of Sysnav, **David Vissière, PhD** has dedicated almost 20 years towards developing 3D motion capture and navigation technology. After 10 years of extensive successful R&D projects with Sysnav in diverse industries such as to major Medical, Military & Defense, Automotive, and Aeronautics companies. Dr. Vissière has been in the forefront by providing and embedding breakthrough magneto-inertial technology for vehicles and pedestrians. David graduated in 1999 from the prestigious Ecole Polytechnique. He obtained his doctorate in 2008 specializing in Mathematics and Automatic Control at MINES ParisTech in which he received the best thesis award in 2009 from ParisTech based on his works on Magnetic-Inertial Navigation. His doctoral studies and research were conducted primarily at the Aerodynamics & Ballistics Research Laboratory, a French DoD's Research Institute where he begins his career as Armament Engineer from 2002 to 2009. In addition to David being voted Engineer of the year in 2010 by l'Usine Nouvelle, he was one of MITs under 35 Top Innovators in 2014, Sysnav was also named National Champion at the 2015/2016 European Business Awards. Today, more than 20 patents later, David VISSIERE, PhD leads a team of 30+ elite engineers bringing ideas to solutions.

From our perspective as industry professionals, we need to look at indoor positioning as not a single market, but instead as a multitude of emerging markets. As a business, we need to find a model that can finance that belief. Over the past decade we have all looked into ideas, solutions, different techniques, however... who really understands the value chain?

### Defining the business models

If we answer yes to the question of "Is there really a need for indoor positioning?", the question becomes: which business model and timing will sustain growth? Clearly, there is

NOT just one business model, because the value chain and user requirements are so vast, the product lifetime is variable, and the market is still at an infancy stage.

### Being robust, as compared to infrastructure-based solutions has a price.

The cost of ours (and yours!) solutions range from engineering innovative ideas, whether that be hardware, software, in-house or out of the box marketing driven solutions. Being the best technology, does not, once again, define what the user needs. And at what price?



## Justyna Redelkiewicz TECHNOLOGY TRENDS IN GEOLOCATION

**Justyna Redelkiewicz** is responsible for promoting Galileo, the European Satellite Navigation System, and its use in context-aware mobile applications. After a few years of work with global chipset manufacturers, she was behind the first Galileo-enabled smartphone launched in 2016, using the European technology for location-based services. Justyna is also in charge of the market and technology research at European GNSS Agency (GSA), managing publications of annual reports on satellite navigation use in various industries.

**The technology in GNSS** user equipment today is more diversified than ever before; ranging from miniaturised, low power GPS chips found in IoT trackers to much larger, more powerful and expensive receivers fitted in passenger aircraft. Furthermore, new models are being introduced at an unprecedented rate, driven by the growing performance requirements of innovative applications, developments in the semiconductor industry and to take advantage of the enhanced capabilities offered by new and modernised GNSS systems and services. In this rapidly evolving landscape, three primary dimensions of change can be

identified for user positioning technology: ubiquity (continuous access to the location information everywhere), automation and ambient intelligence (e.g. enabling autonomous vehicles that can sense their environment and adapt to it) and the provision of more robust, secure solutions (resistant to interference and respecting the privacy of the users). The GNSS user technology is, now more than ever, experiencing a rapid and exciting evolution. During the presentation I will summarize the main findings of technology research in this area performed by the GSA and answer to the question "what works best in geolocation?"



# Keynotes



## Prof. Andrei M. Shkel INERTIAL MEMS SENSORS ARE BECOMING 3D AND ATOMICALLY PRECISE

*Prof. Shkel has been on faculty at the University of California, Irvine since 2000. From 2009 to 2013, he was on leave from academia serving as a Program Manager in the Microsystems Technology Office of DARPA, where he initiated and managed over \$200M investment portfolio in technology development. His research interests are reflected in over 200 publications, 40 patents, and 2 books. Dr. Shkel has been on a number of editorial boards, most recently as Editor of IEEE/ASME JMEMS and the founding chair of the IEEE Inertial Sensors. Dr. Shkel is the IEEE Fellow and the 2018 President-Elect of the IEEE Sensors Council. He has been awarded in 2013 the Office of the Secretary of Defense Medal for Exceptional Public Service, the 2009 IEEE Sensors Council Technical Achievement Award, and the 2005 NSF CAREER award. He received his Diploma with excellence (1991) in Mechanics and Mathematics from Moscow State University, Ph.D. degree (1997) in Mechanical Engineering from the University of Wisconsin at Madison, and completed his postdoc (1999) at the University of California, Berkeley.*

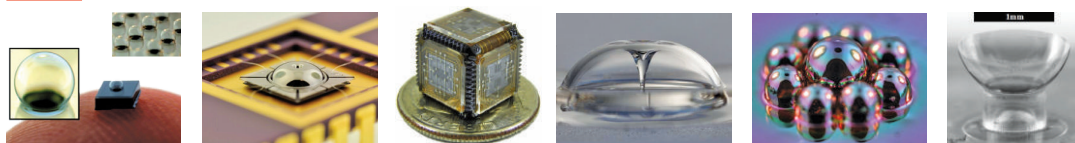

**Microtechnology comes of age.** Clearly, some significant advances have been made, and we see a footprint of the inertial sensors technology in an ever-growing consumer electronics market full of interactive products enabled by microtechnology. These products include, for example, accelerometers for gaming, gyros for auto safety, resonators for clocks, and more. The questions remain, however: Is the technology really on the level of what we consider to be precision sensing? Is

making sensors small necessarily result in degradation of performance? Why do we need the precision of sensing for our daily life and what are the opportunities if we have the precision at our fingertips? I will talk about some of the recent developments toward precision sensing, including an overview of glassblowing technology for 3D wineglass shell gyroscopes, silicon origami-like 3D assembly techniques for solid-state and atomic MEMS, and the futuristic concept of the Ultimate Navigation Chip (uNavChip).



## Dr. Laura Ruotsalainen VISIONS OF NAVIGATION

*Dr. Ruotsalainen is a Research Manager and Deputy Director of the Department of Navigation and Positioning at the Finnish Geospatial Research Institute, Finland, where she leads a research group on Sensors and indoor navigation. She received her doctoral degree in 2013 from the Department of Pervasive Computing, Tampere University of Technology, Finland. Her doctoral studies were partly conducted at the Department of Geomatics Engineering at the University of Calgary, Canada. Her doctoral research was focused on vision-aided seamless indoor/outdoor pedestrian navigation. Her current research interests cover, in addition to vision-aided navigation, adaptive integration of sensors and radio positioning means for robust navigation, situational awareness and GNSS interference mitigation.*



**Humans inherently possess** a good quality “stereo camera”, namely eyes, which is their most important navigation tool. Vision is especially important for choosing the course. Early studies have shown that people tend to veer when blindfolded, which leads them walking in circles and getting lost. Therefore, the use of visual landmarks is the most accurate means of human navigation. It is not a surprise that computer vision is an essential part of navigation of autonomous vehicles. Human visual perception is capable of filling in missing information

enabling the understanding of perspectives and evaluating distances and occluded parts of the objects in the scene, but for computer vision objects in the scene are just sets of points of digitized brightness value functions. Although sophisticated methods already exist, extensive research is still needed for obtaining reliable navigation solutions using computer vision. During this presentation, the use of different means of computer vision in navigation are discussed with an emphasis on the most challenging use case, infrastructure-free pedestrian navigation.

# Tutorials



**Dr. Myriam Servières**

## IF YOU TELL ME WHAT YOU LOOK AT, I COULD TELL YOU WHERE YOU ARE



*Dr. Myriam Servières is associate professor in computer sciences at École Centrale Nantes and a member of the AAU lab since 2006. She received an engineering degree and a DEA (Master) in applied computer science from Centrale Nantes in 2002 then she achieved a PhD in university of Nantes in 2005. Her research interests are in on-site precise geolocalisation, Augmented Reality and usages of such techniques in urban environments.*

In this tutorial we will address the state of the art methods in the computer vision field to get the pose of the camera (position and orientation of the camera optical center) depending on the type of information in the field of view. It will introduce the basis about camera systems

and how to calibrate them. Then it will detail some state of the art methods to calculate the pose based on different inputs as 3D models or extracted features. After retrieving the initial pose, an introduction to some current tracking methods will be given.

## Moisés Navarro-Gallardo, Dr. Gaetano Galluzzo, Martin Šunkevič USING GNSS RAW MEASUREMENTS ON ANDROID DEVICES

TOWARDS BETTER LOCATION PERFORMANCE IN MASS MARKET APPLICATIONS



*Dr. Gaetano Galluzzo is a radio navigation engineer at the European Space Agency (ESA) - European Space Technology and Research Centre (ESTEC), The Netherlands since 2011. His current work focuses on the Galileo system performance verification, development of system monitoring platforms and performance metrics standardization. He graduated in Aerospace Engineering at the University of Naples "Federico II" Italy in 2007 and earned his PhD in Aerospace Engineering from the University of Glasgow UK in 2012. Since 2017 he has been involved in the coordination of an ESA Young Graduate Trainee competition for the implementation of an Android app able to process Galileo raw measurements.*



*Martin Šunkevič has been dealing with satellite navigation and its applications for more than ten years. After finishing studies at Czech Technical University and University of Economics, he started his professional carrier in Czech Space Office as national delegate to European Space Agency in the field of satellite navigation and telecommunication. In 2012 he changed for Ministry of Transport of the Czech Republic, retaining previous responsibilities and adding cooperation on formulation of national space activities strategy. He has been working in European GNSS Agency since april 2015 as Market Development Innovation Officer, being responsible for couple of R&D projects, coordination of GNSS receivers' testing campaign and of two GSA's publications: GNSS Market and GNSS User Technology Reports.*



*Moisés Navarro-Gallardo was born in Ibiza, Spain, in 1986. He received the M.Sc. in Electrical Engineering in 2010 and the Master Degree in Design of Telecommunication Systems in 2011 both from Universitat Autònoma de Barcelona (UAB). He has been involved in the INTEGRA project, working on the synchronization of OFDM systems. In 2011, he has been working on the investigation of signal processing techniques for unambiguous tracking for GNSS signals, especially PRS-like BOC modulations at ESTEC-ESA, Noordwijk, The Netherlands. He has been working in ESA Navigation Receiver laboratories supporting Galileo program during the IOT and IOV phases and several projects related to Galileo and GNSS receivers. Since 2015 he is working in Airbus as Navigation User Receiver Testing Engineer. Since 2016 he is supporting GSA within the Galileo System contract acting as technical leader of the User Segment Support team.*

**The tutorial will focus on GNSS raw measurements and their implementation on the Android platform, available from version 7 Nougat. The tutorial will cover:**

- GNSS basics needed for understanding the raw measurements like GNSS receiver architecture, importance of time, navigation message, pseudorange generation or position estimation.
- Information on how to generate the GNSS reference time and step-by-step approach for deriving the pseudoranges from Android.
- Opportunities and practical use of GNSS raw measurements with particular focus on the use of Galileo.
- Market potential and examples of application areas that could benefit from using raw measurements.

**Make your notes and keep track of your ideas and impressions thanks to the “notebook” sections.**

2.

**Extract  
paper**

# A1.1. CONTINUOUS POSE ESTIMATION FOR URBAN PEDESTRIAN MOBILITY APPLICATIONS ON SMART-HANDHELD DEVICES

Nicolas Antigny, France, nicolas.antigny@ifsttar.fr - Myriam Servières, France, myriam.servieres@ec-nantes.fr  
Valérie Renaudin, France, valerie.renaudin@ifsttar.fr

**Key words:** Pedestrian navigation, Pose estimation, Urban mobility, Augmented Reality

To support pedestrian navigation in urban and indoor spaces, an accurate pose estimate (i.e. 3D position and 3D orientation) of an equipment held in hand constitutes an essential point in the development of mobility assistance tools (e.g. Augmented Reality applications). On the assumption that the pedestrian is only equipped with general public devices, the pose estimation is restricted to the use of low-cost sensors embedded in the latter (i.e. an Inertial and Magnetic Measurement Unit and a monocular camera). In addition, urban and indoor spaces, comprising closely-spaced buildings and ferromagnetic elements, constitute challenging areas for sensor pose estimation during large pedestrian displacements. However, the recent development and provision of 3D Geographical Information System content by cities constitutes a wealth of data usable for pose estimation. To address these challenges, we propose an autonomous sensor fusion framework for pedestrian hand-held device pose estimation in urban and indoor spaces. The proposed solution integrates inertial and magnetic-based

attitude estimation, monocular Visual Odometry with pedestrian motion estimation for scale estimation and known 3D geospatial object recognition-based absolute pose estimation. Firstly, this allows to continuously estimate a qualified pose of the device held in hand. Secondly, an absolute pose estimate enables to update and to improve the positioning accuracy.

To assess the proposed solution, experimental data has been collected, for four different people, on a 0.5 km pedestrian walk in an urban space with sparse known objects and indoors passages. According to the performance evaluation, the sensors fusion process enhanced the pedestrian localization in areas where conventional hand-held systems were not accurate or available.

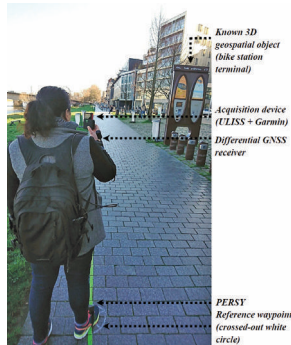

note book

# A1.2. ERROR ANALYSIS OF ZUPT-AIDED PEDESTRIAN INERTIAL NAVIGATION

Yusheng Wang, University of California, Irvine, CA, USA, yushengw@uci.edu  
Andrei Chernyshoff, Independent consultant, Irvine, CA, USA  
Andrei M. Shkel, University of California, Irvine, CA, USA.

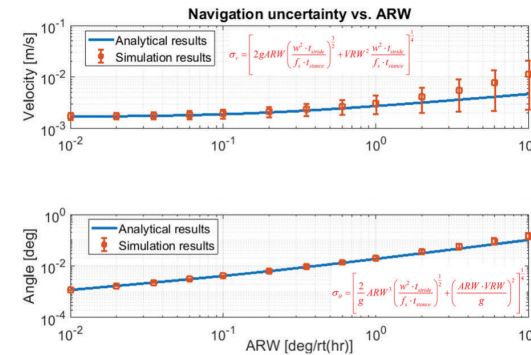

note book

**Key words:** Pedestrian navigation, ZUPT, Human gait model, Kalman filter, Navigation error

We present, for the first time, an analytical relation between the navigation errors during Zero-Velocity-Update (ZUPT) aided pedestrian inertial navigation and Inertial Measurement Unit (IMU) performances. Angle Random Walk of gyroscopes and Velocity Random Walk of accelerometers in IMU, velocity measurement uncertainty during the stance phase, and the sampling frequency of IMU are studied and their effects on the overall navigation accuracy are analyzed. Numerical simulation of the ZUPT-aided navigation algorithm is conducted based on a generated pedestrian trajectory to verify the analytical results with the discrepancy less than 30%, showing fidelity of the results. In this study, a foot motion model was developed according to the ambulatory gait analysis as a basis of the numerical simulation. This study may serve as a benchmark for analysis of errors in pedestrian inertial navigation.



## A1.3. COPERNICUS: A ROBUST AI-CENTRIC INDOOR POSITIONING SYSTEM

Yiannis Gkoufas, IBM Research Ireland, yiannisg@ie.ibm.com  
Kostas Katrinis, IBM Research Ireland

**Key words:** *Indoor positioning system, Magnetic field, AI, Learning*

Indoor Positioning Systems (IPS) are gaining market momentum, mainly due to the significant reduction of sensor cost (on smartphones or standalone) and leveraging standardization of related technology. Among various alternatives for accurate and cost-effective IPS, positioning based on the Magnetic Field has proven popular, as it does not require specialized infrastructure. Related experimental results have demonstrated good positioning accuracy. However, when transitioned to production deployments, these systems exhibit serious drawbacks to make them practical: a) accuracy fluctuates significantly across smartphone models and configurations and b) costly continuous manual fingerprinting of the area is required. In this paper we propose Copernicus, a self-learning, adaptive system that is shown to exhibit improved accuracy across different smartphone models. Copernicus leverages a minimal

deployment of BLE Beacons to infer the trips of users, learn and eventually build tailored Magnetic Maps for every smartphone model for the specific indoor area. Our experimental results show the positive impact in the positioning, even in case of minimal learning.

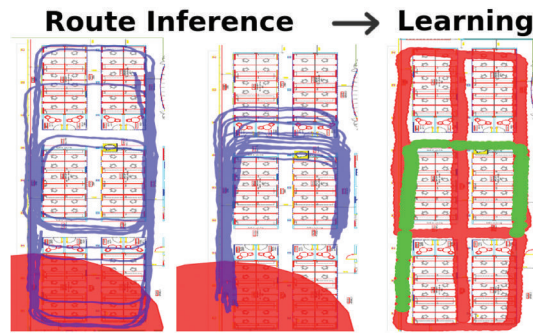

note  
book

## A1.4. CROWD-SOURCING RF PROFILES FOR STORE VISIT CONFIRMATION USING SLAM

Firas Alsehly, UK, f.alsehly@sensewhere.com  
Wennan Chai, UK - Francisco Zampella, UK - Arief Juri, UK

note  
book

**Key words:** *Visit Confirmation, Simultaneous Localization And Mapping, Crowd Sourcing, Location based Service, Pedestrian Dead Reckoning, InStore Classification*

Recent development on commercial oriented indoor positioning has encouraged retailers to demand more insights and knowledge about store visits. Such demands have triggered various ways of extracting location attributes deep indoors to enable accurate and detailed insights. Nevertheless, available solutions are very limited to specific venues and usually requires intensive setup or calibration. These limitations challenges researchers to find alternative solution that could be scaled beyond customization of beacons or the expensive fingerprinting approach. In this paper we propose a hybrid system that utilizes crowd-sourcing data to trace anonymous device location history as well as store's signal profiles. The proposed solution extends sensewhere's Simultaneous Localization And Mapping (SLAM) system employing "InStore" classification through crowd-sourcing of spatial features. We further propose algorithms to estimate the probability of a mobile device being in given store within a building with complex layout (e.g. a shopping mall). Our approach focuses on a trajectory-based solution as we examine both location data and WiFi signals detected by the mobile device along a track to estimate InStore probability.

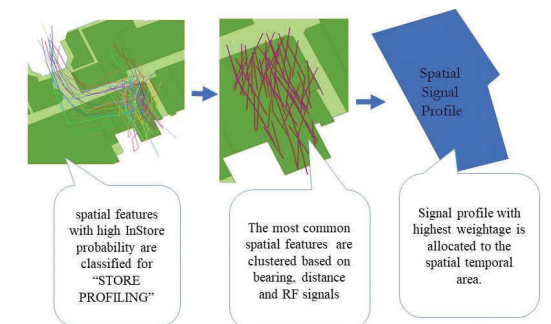

## A2.1. COMPARING HEADING ESTIMATES FROM MULTIPLE WEARABLE INERTIAL AND MAGNETIC SENSORS MOUNTED ON LOWER LIMBS

Chandra Tjhai, chandra.tjhai@ucalgary.ca and Kyle O'Keefe, kpgokeef@ucalgary.ca  
Position, Location, And Navigation (PLAN) Group, Department of Geomatics Engineering, University of Calgary, Alberta, Canada

**Key words:** *Wearable, Inertial, Magnetometer, Sensor fusion*

This paper presents heading estimations from multiple low-cost wearable sensors distributed on the lower limb segments. A low-cost commercial motion capture suit from Enflux is used to record accelerometer, gyroscope and magnetometer measurements. Roll and pitch angles from each sensor are estimated to level each magnetometer. The sensor orientations are computed using a Kalman filter. The step length is computed using the sensor mounted on the pelvis while the stride length is computed using the foot-mounted sensors. The results show that the pelvis is the best location to track pedestrian heading while other sensors have poor performance due to difficulty in estimating the roll and pitch angles.

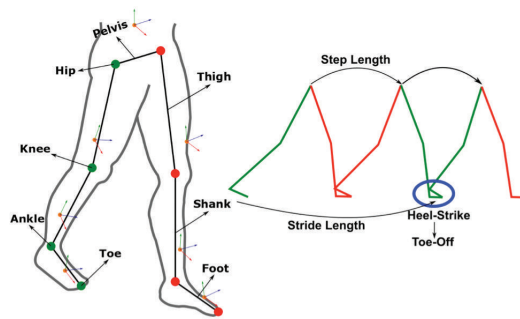

note book

## A2.2. INTELLIGENT URBAN MOBILITY: PEDESTRIAN AND BICYCLE SEAMLESS NAVIGATION

Estefania Munoz Diaz, Germany, estefania.munoz@dlr.de  
Fabian de Ponte Müller, Germany - Eduardo Pérez González, Germany

**Key words:** *Magnetometer, Coasting, Multimodal transportation, Ubiquitous navigation*

Mobility is evolving in urban scenarios and multimodality is the key to a more efficient transportation. In this article we propose a multimodal intelligent navigation system for urban indoor and outdoor environments. Our method is based on wearable sensors mounted on different locations on the human body. The algorithm based on a loose INS/GNSS fusion with magnetometers switches intelligently and seamlessly between the transportation modes walking and riding a bicycle. We also propose an algorithm to cover the still unsolved issue regarding coasting and braking periods for bicycle navigation in GNSS denied scenarios. We have performed an extensive measurement campaign of more than 12Km



to test the performance of the proposed algorithms and we have used a Precise Point Positioning solution as ground truth to compute the error. We prove that our method is able to successfully estimate the forward speed of the bicycle during coasting or braking periods. Likewise, we prove that our navigation system switches seamlessly between walking and riding a bicycle and is also able to bridge short GNSS outages.

note book

## A2.3. MOTION CONTEXT ADAPTIVE FUSION OF INERTIAL AND VISUAL PEDESTRIAN NAVIGATION

Jesper Rantanen, Finland, [jesperi.rantanen@nls.fi](mailto:jesperi.rantanen@nls.fi)  
 Maija Mäkelä, Finland - Laura Ruotsalainen, Finland - Martti Kirkko-Jaakkola, Finland

**Key words:** Context awareness, Indoor navigation, Inertial navigation, Sensor Fusion, Visual odometry

We use motion context recognition to enhance the result of our infrastructure-free indoor navigation algorithm. Target applications are difficult navigation scenarios such as first responder, rescue, and tactical applications. Our navigation algorithm uses inertial navigation and visual navigation fusion. Random Forest classifier algorithm is taught with training data from Inertial Measurement Unit and visual navigation data to classify between walking, running and climbing. This information is used both in pedestrian navigation to do stationarity detection with adaptive threshold and in particle filter fusion to exclude visual data from during climbing. Methods are evaluated in an indoor navigation test where person wearing tactical equipment moves through a building. Results show improvement of positioning accuracy based on loop closure error on the test track especially when the movement is fast paced. The loop closure error was reduced on average 4% in two tests when movement was slow and 14% when movement was fast.

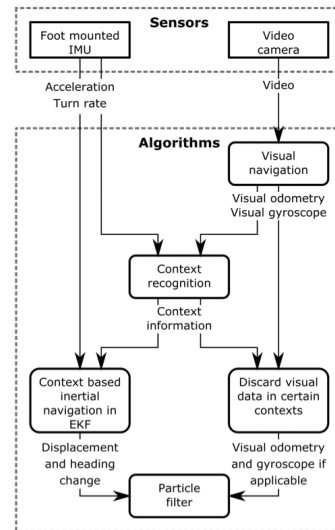

note book

## A2.4. FAST LINEAR ATTITUDE ESTIMATION AND ANGULAR RATE GENERATION

Zeliang Zhang, China - Zebo Zhou, China - Jin Wu, China - Shuang Du, China  
 Hassen Fourati, France, [hassen.fourati@grenoble-inp.fr](mailto:hassen.fourati@grenoble-inp.fr)

**Key words:** Attitude estimation, Kalman filter, Wahba's problem, Angular rate estimation

This paper focuses on the approach to attitude estimation and virtual gyroscope compensation. First, the rotation transformation is built between the body frame and the reference frame by means of an accelerometer-magnetometer triad. Fast linear attitude estimation method is used in the process to improve the computation efficiency. The attitude quaternion is invoked for parameterization of orientation in Kalman filtering. Furthermore, to generate the virtual-gyro output in the case of gyroscope failures, virtual-gyro Kalman filter is established for angular rate estimation. Experiments are carried out to illustrate the validity and efficiency of the proposed attitude and angular rate estimation approaches.

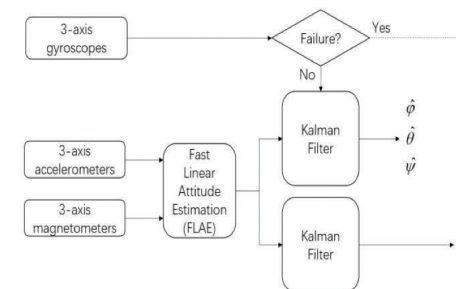

note book

## A2.5. A PEDESTRIAN POSITIONING SYSTEM INTEGRATED INTO A CYBER-PHYSICAL SYSTEM FOR EMERGENCY RESPONDERS' MONITORING

André G. Ferreira, Portugal, andrefilipegoncalvesferreira@gmail.com  
 Duarte Fernandes, Portugal - João Monteiro, Portugal - André P. Catarino, Portugal - Ana M. Rocha, Portugal

*Key words: Cyber-Physical Systems (CPS), Emergency Responders, Indoor Positioning Systems (IPSs), Pedestrian Dead Reckoning (PDR), Unstructured and Unknown Environments*

An Indoor Positioning System (IPS) is a key component of a Cyber-Physical System (CPS) for emergency responders' monitoring during on-duty missions. In this paper, the Pedestrian Dead Reckoning (PDR) sub-system of the PROTACTICAL CPS is presented and evaluated. Firstly, the architecture of the PROTACTICAL CPS is introduced, then we introduce the node responsible for computing the position of the emergency responder based on the PDR approach and the theory behind our implementation. Five different paths were selected to evaluate the performance of our system, which include 2D and 3D scenarios. The Euclidean distance between the starting and final points and the total distance travelled were the metrics selected for the system performance evaluation. Although the tracking capabilities of the proposed system are quite evident, the error of the total distance travelled does not comply with the requirements of an IPS for emergency responders. The system reported an error up to 17% of the total distance travelled.

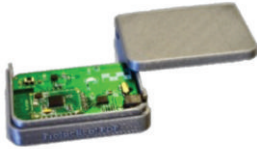
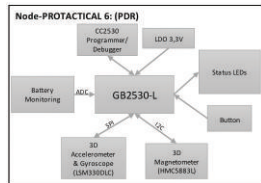

note  
book

## A2.6. 3D LOOSE-COUPLED FUSION OF INERTIAL SENSORS FOR PEDESTRIAN LOCALIZATION

Dina Bousdar Ahmed, Germany, dina.bousdarahmed@dlr.de  
 Estefania Munoz Diaz, Germany

*Key words: Height, Sensor fusion, PDR, IMU, Dead reckoning, Multi-IMU navigation, MEMS*

This work focuses on the development of a position tracking algorithm for pedestrians using, simultaneously, two inertial sensors. Our goal is to extend, from 2D to 3D, a loosely-coupled system that combines a foot-mounted inertial navigation system (INS) and a pocket-mounted INS. In order to estimate the vertical displacement of the pedestrian's walked trajectory, we use the pocket INS to detect when the user is walking the stairs. Upon stairs detection, the vertical displacement is estimated through the position estimated by the foot INS. The vertical displacement is then integrated in the filter of the loosely coupled system. The results show an improvement of 48%

regarding the average height error of the foot INS. In fact, the estimated height drifts less than the foot INS estimated height when the user walks on a horizontal surface. Nevertheless, the proposed approach does not outperform the pocket INS. In conclusion, the 3D loose coupling has a reduced height drift in horizontal surfaces, while it estimates vertical displacements without any height model.

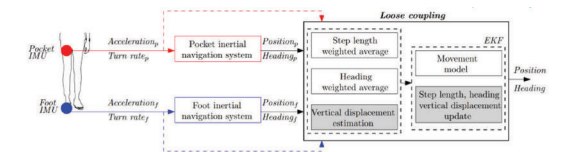

note  
book

## A3.1. SMILE - SIMULATOR FOR METHODS OF INDOOR LOCALIZATION

Tomasz Jankowski, Poland, t.jankowski@pwr.edu.pl  
Maciej Nikodem, Poland

**Key words:** Localization, Algorithms, Positioning, Simulation

This paper presents SMILE - a new tool for developing and evaluating indoor localization methods utilizing time measurements such as Time Difference of Arrival (TDoA) or Time of Flight (ToF). Proposed solution includes highly configurable simulator based on OMNET++ and a Python package dedicated for data analysis and

post-processing. SMILE also aims to aid researchers around the world in comparing and benchmarking various localization methods. The presented tool enables users to evaluate different localization systems in controllable simulation environment. This paper describes in detail SMILE's design goals and capabilities.

note  
book

## A3.2. RECURRENT NEURAL NETWORKS ON DRIFTING TIME-OF-FLIGHT MEASUREMENTS

Tobias Feigl, Germany, tobias.feigl@fau.de  
Thorsten Nowak, Germany - Michael Philippsen, Germany  
Thorsten Edelhäußer, Germany - Christopher Mutschler, Germany

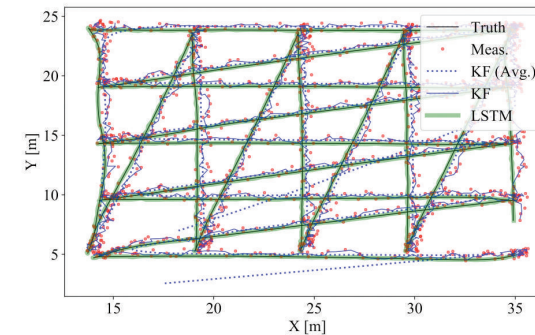

**Key words:** Long short-term memory, Time-of-flight, TOA drift

Kalman filters (KFs) are popular methods to estimate position information from a set of time-of-flight (ToF) values in radio frequency (RF)-based locating systems. Such filters are proven to be optimal under zero-mean Gaussian error distributions. In presence of multipath propagation ToF measurement errors drift due to small-scale motion. This results in changing phases of the multipath components (MPCs) which cause a drift on the ToF measurements. Thus, on a short-term scale the ToF measurements have a non-constant bias that changes while moving. KFs cannot distinguish between the drifting measurement errors and the true motion of the tracked object. Hence, very rigid motion models have to be used for the KF which commonly causes the filters to diverge. Therefore, the KF cannot resolve the short-term errors of consecutive measurements and the long-term motion of the tracked object.

This paper presents a data-driven approach that uses training sequences to derive a near-optimal position estimator. A Long Short-Term Memory (LSTM) Recurrent Neural Network (RNN) learns to interpret drifting errors in ToF measurements of a tracked dynamic object directly from raw ToF data. Our evaluation shows that our approach outperforms state-of-the-art KFs on both synthetically generated and real-world dynamic motion trajectories that include drifting ToF measurement errors.

note  
book

### A3.3. IMPROVED TIME OF ARRIVAL MEASUREMENT MODEL FOR NON-CONVEX OPTIMIZATION WITH NOISY DATA

Juri Sidorenko<sup>1&2</sup>, juri.sidorenko@iosb.fraunhofer.de

Volker Schatz<sup>1</sup>, Norbert Scherer-Negenborn<sup>1</sup>, Michael Arens<sup>1</sup>, Urs Hugentobler<sup>2</sup>

<sup>1</sup>: Fraunhofer Institute of Optronics, System Technologies and Image Exploitation IOSB, Ettlingen, Germany

<sup>2</sup>: Institute of Astronomical and Physical Geodesy, Technical University of Munich, Munich, Germany

**Key words:** Localization, Navigation, Time of arrival, Non-linear optimization

The quadratic system provided by the Time of Arrival technique can be solved analytical or by non-linear least squares minimization. In real environments the measurements are always corrupted by noise. This measurement noise effects the analytical solution more than non-linear optimization algorithms. On the other hand it is also true that local optimization tends to find the local minimum, instead of the global minimum. This article presents an approach how this risk can be significantly reduced in noisy environments. The main idea of our approach is to transform the local minimum to a saddle point, by increasing the number of dimensions. In addition to numerical tests we analytically prove the theorem and the criteria that no other local minima exists for non-trivial constellations.

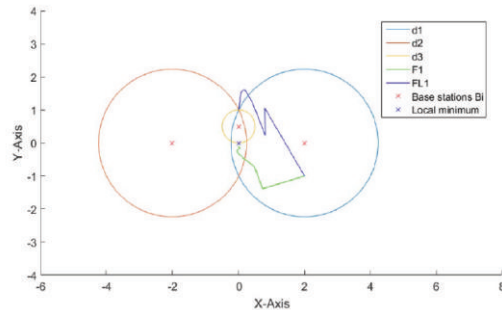

Fig. 4. Iteration steps of the Levenberg-Marquardt algorithm for  $F_1$  and  $F_{L1}$ .  $F_1$ : Objective function  $F_1$ .  $F_{L1}$ : Improved objective function  $F_{L1}$ . Blue line: Optimization steps. Green line: Optimization steps improved function. The blue, red and yellow circles are the distances between base stations  $B_i$  and transponder  $T$ .

note book

### A3.4. SMARTPHONE LOCALIZATION USING ACTIVE-PASSIVE ACOUSTIC SENSING

Hiroaki Murakami, Japan, hmurakami@ist.hokudai.ac.jp

Masanari Nakamura, Japan, nmasanari@frontier.hokudai.ac.jp - Shoma Yamasaki, Japan, yshoma@ist.hokudai.ac.jp

Hiromichi Hashizume, Japan, has@nii.ac.jp - Masanori Sugimoto, Japan, sugi@ist.hokudai.ac.jp

note book

**Key words:** Active and passive acoustic sensing, TDoA, Smartphone, Microphone

In this paper, we describe a novel position-recognition method that uses passive acoustic signals from two previously installed speakers (passive acoustic sensing) and active acoustic signals from a smartphone's loudspeakers (active acoustic sensing). In passive acoustic sensing, a locus of positions for the smartphone can be calculated from the measured time difference of arrival from the two installed speakers. In active acoustic sensing, a chirp signal is transmitted from the speakers of the smartphone, and the distance to the side wall is measured from the propagation time of arrival at its microphone. We can obtain the smartphone position from our proposed model equations by combining these two results. In our experiments, we installed speakers at intervals of 10 m along a corridor and estimated the smartphone position at several places. From these results, we obtained 90<sup>th</sup> percentile errors of less than 0.224 m for 2-D positioning. We found that multipaths from the side wall were causing the positioning error in passive acoustic sensing, and the variance of the positioning error using the top microphone which was omnidirectional was smaller than the bottom one. When we introduced a weighting based on the result of the active acoustic sensing and the difference in the performance between microphones, the 90<sup>th</sup> percentile errors were reduced to less than 0.134 m.

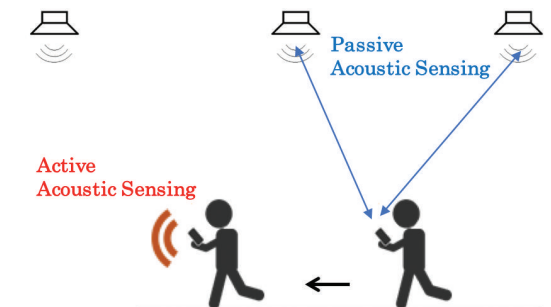

## A3.5. EVALUATION OF RANGE ERROR CALIBRATION MODELS FOR INDOOR UWB POSITIONING APPLICATIONS

Harris Perakis, Greece, hperakis@central.ntua.gr  
Vassilis Gikas, Greece, vgikas@central.ntua.gr

*Key words: UWB, RF ranging, Calibration, Range error modelling, Indoor positioning*

Recent improvements in the field of wireless technologies has led to an increase of available tools for Location Based Services (LBS). Modern indoor LBS applications continually raise the bar of requirements for the employed positioning technology and Ultra-Wide Band (UWB) ranging has become relevant by providing adequate performance. UWB employs modulated impulse signals for achieving ranging accuracies in the order of cm offering increased capabilities compared to other Radio-Frequency ranging methods. In order for the UWB systems to function reliably in complex indoor environments, error mitigation techniques are employed based on ranging error modelling methods. In this study, a commercial UWB system (Time Domain®) is employed for the development of error calibration models based on data collected in an indoor office environment. Three calibration methods are examined both for static and kinematic test scenarios. An overall improvement of 32%-86% is demonstrated for the static UWB ranges data while a 74% improvement on kinematic data results in a mean trajectory accuracy of 9 cm.

note  
book

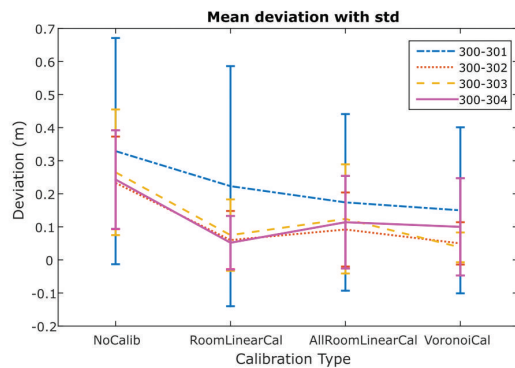

## A4.1. GRAVITY DIRECTION ESTIMATION AND HEADING DETERMINATION FOR PEDESTRIAN NAVIGATION

Adi Manos, Israel, adimanos@campus.technion.ac.il  
Itzik Klein, Israel - Tamir Hazan, Israel

*Key words: Pedestrian dead reckoning, Gravity direction estimation, Heading determination, Smartphone sensors*

One of the common ways to perform indoor localization for pedestrians is to employ the smartphone's inertial sensors, in a process known as pedestrian dead reckoning (PDR). Estimation of the pedestrian's heading is a crucial step in PDR algorithms, since it is a key factor in the positioning accuracy. In this paper, rather than assuming the smartphone to be fixed in a certain orientation

on the pedestrian, we focus on estimating the vertical direction within the sensor frame of an unconstrained device. To that end, we establish a framework for gravity direction estimation and highlight the important role it has for solving the heading in the horizontal plane. By employing only accelerometers and gyroscopes, we derive, present and compare different approaches both for estimating the gravity direction and for computing the heading angle. The results are demonstrated and analyzed using data recorded from field experiments.

note  
book

## A4.2. LOCATION OF PERSONS USING BINARY SENSORS AND BLE BEACONS FOR AMBIENT ASSISTIVE LIVING

Antonio R. Jimenez - Fernando Seco - Pekka Peltola - Macarena Espinilla

**Key words:** *Indoor localization, Bluetooth tags, BLE beacons, RSSI, Capacitive floor, Smart-watch, Particle filter, AAL*

In ambient assistive living (AAL) it is of a paramount importance to be able to detect, localize and estimate the activities of persons living at their homes. Specially, estimating an accurate person's localization and detailed movement patterns in everyday activities, are very valuable for health monitoring and safety assessment. The indoor positioning and navigation (IPIN) research community mainly concentrates on the use of radio beaconing for trilateration with WiFi, Bluetooth or UWB, acoustic beaconing, inertial pedestrian dead-reckoning, and the fusion of several approaches, using fingerprinting or Bayesian estimators. In the area of activity recognition (AR) authors use different kind of sensors such as smart floors, binary sensors attached to common objects, or infer the proximity to objects using Bluetooth beacons. In this paper we want to join these two different field approaches (IPIN and AR) by proposing an indoor localization

method that make use of smart floor information, binary sensors, and the signal strength received at a smartwatch coming from BLE beacons deployed in a smartlab. We use the smart floor as a ground truth in order to estimate location accuracy of persons in a totally unobtrusive way. The localization results, for a person moving in the smart livinglab during 10 days, showing accuracies below 1.5 meter in 80% of the cases. The proposed approach can help the tracking of multiple persons living together and also serve as a complement to improve the performance of location-aware activity recognition algorithms.

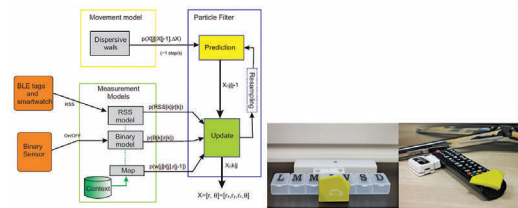

note book

## A4.3. A LOOSELY COUPLED COOPERATIVE LOCALIZATION AUGMENTATION TO IMPROVE HUMAN GEOLOCATION IN INDOOR ENVIRONMENT

Jianan Zhu, USA, solmaz@uci.edu - Solmaz S. Kia, USA

**Key words:** *Cooperative localization, Human agent, Consistency, Communication, UWB ranging*

This paper reports on the use of a cooperative localization augmentation to increase the localization accuracy of human agents in an opportunistic fashion by processing inter-agent relative measurements. The main challenge in the decentralized cooperative localization algorithm design is how to account for the strong correlations, which the relative measurement updates create between the state estimates of the agents, with a reasonable communication cost. To keep track of the correlations agents need to communicate with each other through some form of a network-wide communication topology, which is hard to maintain for human agent localization applications. In this paper, we discuss a cooperative localization method that, instead of maintaining the correlations, accounts for them in an implicit manner by using conservative upper-bound estimates on the joint correlation matrix of the agents. This provably consistent loosely coupled cooperative localization method requires only the two agents involved in a relative range measurement to communicate with each other. Our results include the use of this algorithm for human agent localization via UWB ranging sensors. We demonstrate our results in simulation and experiments.

note book

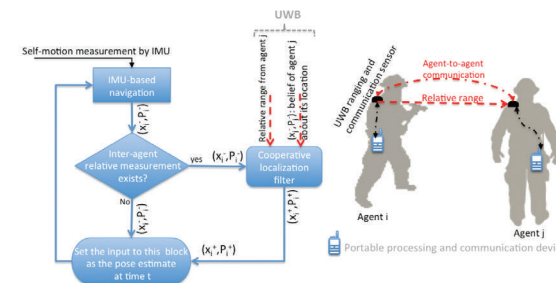



## A4.4. SMARTPHONE-BASED USER POSITIONING IN A MULTIPLE-USER CONTEXT WITH WI-FI AND BLUETOOTH

Viet-Cuong Ta, Vietnam, cuongtv@vnu.edu.vn - Trung-Kien Dao, Vietnam  
Dominique Vaufreydaz, France - Eric Castelli, France

**Key words:** *Wi-Fi, Bluetooth, Collaborative positioning, Particle filter*

In a multi-user context, the Bluetooth data from the smartphone could give an approximation of the distance between users. Meanwhile, the Wi-Fi data can be used to calculate the user's position directly. However, both the Wi-Fi-based position outputs and Bluetooth-based distances are affected by some degree of noise. In our work, we propose several approaches to combine

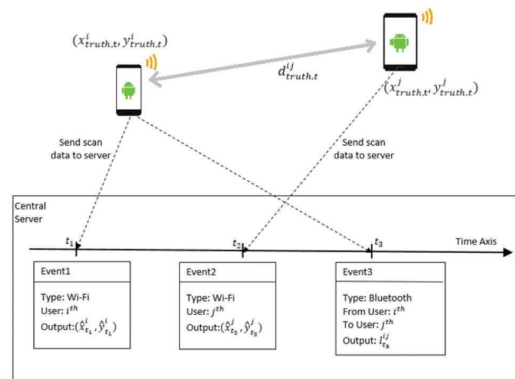

the two types of outputs for improving the tracking accuracy in the context of collaborative positioning. The two proposed approaches attempt to build a model for measuring the errors of the Bluetooth output and Wi-Fi output. In a non-temporal approach, the model establishes the relationship in a specific interval of the Bluetooth output and Wi-Fi output. In a temporal approach, the error measurement model is expanded to include the time component between users' movement. To evaluate the performance of the two approaches, we collected the data from several multi-user scenarios in indoor environment. The results shows that the proposed approaches could reach a distance error around 3.0m for 75 percent of time, which outperforms the positioning results of the standard Wi-Fi fingerprinting model.

note book

## A4.5. KALMAN-TYPE FILTERS AND SMOOTHERS FOR PEDESTRIAN DEAD RECKONING

Pavel Ivanov, Finland, pavel.ivanov@here.com  
Matti Raitoharju, Finland - Robert Piché, Finland

note book

**Key words:** *Indoor positioning, Kalman Filter, PDR*

In this paper, we present a method for device localization based on the fusion of location data from Global Navigation Satellite System and data from inertial sensors. We use a Kalman filter as well as its non-linear variants for real-time position estimation, and corresponding smoothers for off-line position estimation.

In all filters we use information about changes of user's heading, which are computed from the acceleration and gyroscope data. Models used with Extended and Unscented Kalman filters also take into account information about step length, whereas Kalman Filter does not, because the measurement is non-linear. In order to overcome this shortcoming, we introduce a modified Kalman Filter which adjusts the state vector according to the step length measurements.

Our experiments show that use of step length information does not significantly improve performance when location measurements are constantly available. However, in real situations, when location data is partially unavailable, information about step length and its appropriate integration into the filter design is important, and improve localization accuracy considerably.

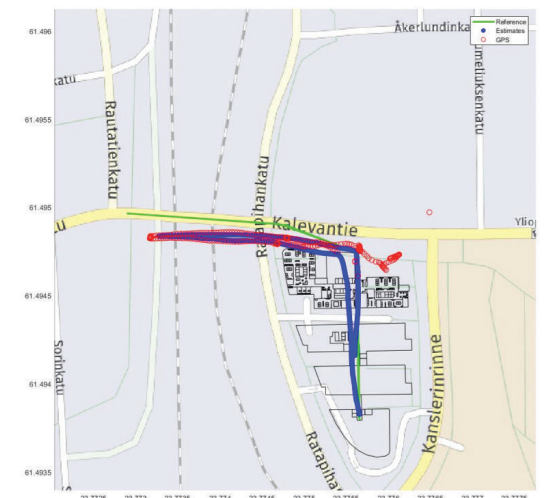

# A5.1. FASTGRAPH – ORGANIC 3D GRAPH FOR UNSUPERVISED LOCATION AND MAPPING

Cristiano Pendão, Portugal, cpendao@dsi.uminho.pt - Adriano Moreira, Portugal

**Key words:** Indoor Positioning, Wi-Fi SLAM, Unsupervised, 3D-Graph, Force-Directed, AP-Position Estimation

It is well-known that fingerprinting-based positioning requires an exhaustive calibration phase to create a radio map, which often requires recalibration. Model-based and geometric approaches try to mitigate this effort at the expense of a lower accuracy or high computational cost. This paper introduces FastGraph, where a 3D graph is used to rapidly model the radio propagation environment. By means of unsupervised techniques, FastGraph is able to operate shortly after its deployment without previous knowledge about the environment. The proposed solution uses a novel algorithm to automatically provide location while simultaneously updating the radio map; and learn the position of the Access

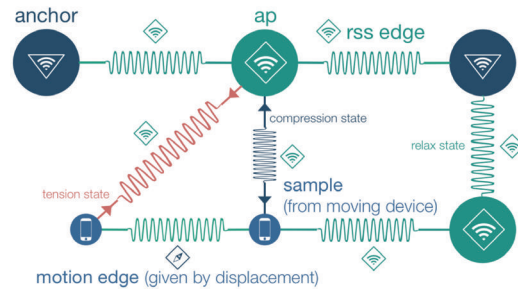

Points (APs) and location-specific radio propagation parameters. FastGraph has been evaluated in two real-world environments, a factory-plant and a regular university building, with results comparable to those obtained by conventional radio map-based solutions.

note book

# A5.2. ACCURATE FIDUCIAL MAPPING FOR POSE ESTIMATION USING MANIFOLD OPTIMIZATION

Xiao Hu, National Space Institute, Technical University of Denmark, Denmark, xiahaa@space.dtu.dk  
 Jakobsen Jakob, National Space Institute, Technical University of Denmark, Denmark, jj@space.dtu.dk  
 Knudsen Per, National Space Institute, Technical University of Denmark, Denmark, pk@space.dtu.dk  
 Wei Jiang, Beijing Jiaotong University, weijiang@bjtu.edu.cn

**Key words:** Fiducial Markers, Mapping, Localization, Pose Estimation, Manifold, Pose Optimization

The accurate pose estimation for moving objects within a given workspace is one of the most fundamental tasks for many applications including augmented reality, robotics' control, planning and navigation. The information of objects' pose is often given by motion capture systems and global positioning systems indoor and outdoor respectively. However, motion capture systems are costly and limited in workspace, while global positioning systems degrade severely in clustering environments. In this paper, we propose an approach to build a map of fiducial markers based on manifold optimization and then extend the fiducial map for pose estimation. The fiducial map based pose estimation system is cost-effective, lightweight and can work both indoor and outdoor. The proposed method starts by fiducial detection and pose estimation for collected images in order to establish an initial graph which stacks measurements of markers' relative poses. Then for each relative pose, multiple measurements are fused using manifold optimization for an optimal estimation. To deal with pose ambiguity problem, inlier poses are selected using the random sample consensus algorithm. Finally, a global pose optimization is done on manifold to minimize per frame reprojection errors. Mapping experiments with synthetic and real data demonstrated the accuracy and consistency of the proposed approach. The accuracy of pose estimation using prebuilt fiducial map was evaluated by benchmark tests with motion capture system.

note book

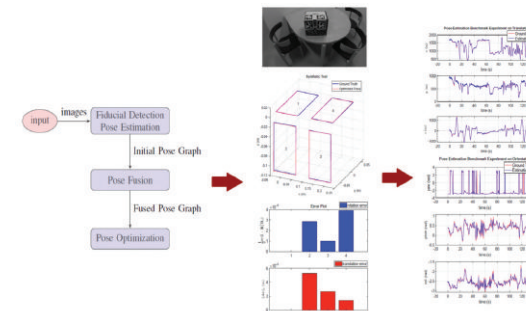

## A5.3. REGISTRATION AND MERGING MAPS WITH UNCERTAINTIES

Martin Larsson, Sweden, martin.larsson@math.lth.se  
Kalle Åström, Sweden - Magnus Oskarsson, Sweden

**Key words:** Rigid registration, Merging, Time-of-arrival, SLAM, Covariance, Mapping

In this paper we address the problem of registering and merging two maps in two dimensions, given covariance estimates of the two maps. We show that if two maps are given in the same coordinate system, then the problem of merging them in a statistically optimal way can be formulated as a linear least squares problem, but if they are given in different coordinate systems as well the problem becomes highly non-linear and non-convex. We show how we can relax the problem slightly in order to optimize over the registration (i.e. putting the two maps in the same coordinate system) and at the same time optimize over the merged map. The approach is based on finding all stationary points of the optimization problem and evaluating these to choose the global optimum. We show on synthetic data that in many cases the proposed approach gives better results than naively registering and merging the maps. We also show results on real data, where we merge maps given by time-of-arrival measurements, and in these cases simpler linear methods perform just as good as the proposed method.

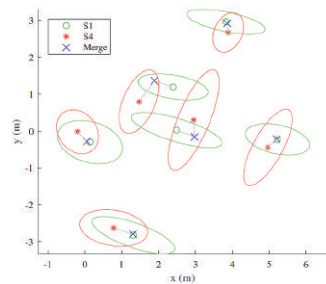

The figure shows two maps, S1 and S4, derived from real data that have been registered and merged using the proposed method. The covariance of the maps is illustrated with ellipses and the resulting merged map is shown in blue. Five different methods for performing registration and merging were tested on real and synthetic data. Four of them performed similarly except in cases of very anisotropic noise.

note  
book

## A5.4. MOMA: VISUAL MOBILE MARKER ODOMETRY

Raul Acuna, Germany, racuna@rnr.tudarstadt.de  
Zaijuan Li, Germany - Volker Willert, Germany

**Key words:** Visual odometry, Vision, Cooperative, Robots, Fiducial marker, Pose estimation

In this paper, we present a cooperative visual odometry system based on the detection of mobile markers. To this end, we introduce a simple scheme that realizes visual mobile marker odometry via accurate fixed marker-based camera positioning and we discuss the characteristics of errors inherent to the method compared to classical fixed marker-based navigation and visual odometry. The proposed cooperative scheme has the advantage of not needing any feature or fiducial marker in the environment, which can be useful on indoor and underwater applications where it can be harder to extract reliable features. We provide specific configurations of UAV and UGV robots including one that allows continuous movements of the UAV, and a minimal caterpillar-like

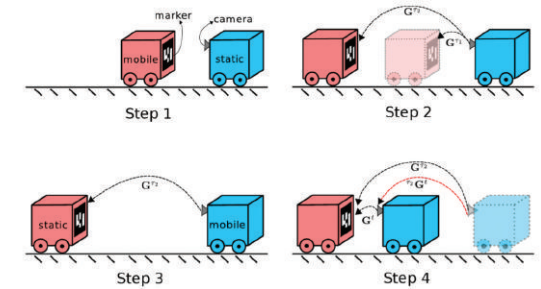

Two-robot caterpillar visual odometry

configuration that works with one UGV alone. Finally, we present a real-world implementation and an evaluation of the proposed configurations.

note  
book

## A5.5. A RADIO-INERTIAL LOCALIZATION AND TRACKING SYSTEM WITH BLE BEACONS PRIOR MAPS

Maani Ghaffari Jadidi, Department of Naval Architecture and Marine Engineering, University of Michigan, Ann Arbor, MI 48109 USA, maanigj@umich.edu

Mitesh Patel - Jaime Valls Miro - Gamini Dissanayake - Jacob Biehl - Andreas Girsensohn

**Key words:** Localization, SLAM, Particle Filtering, Nonlinear Filtering, Probability and Statistical Methods, Range Sensing, Radio-Inertial Localization and Tracking

In this paper, we develop a system for the low-cost indoor localization and tracking problem using radio signal strength indicator, Inertial Measurement Unit (IMU), and magnetometer sensors. We develop a novel and simplified probabilistic IMU motion model as the proposal distribution of the sequential Monte-Carlo technique to track the robot trajectory. Our algorithm can globally localize and track a robot with a priori unknown location, given an informative prior map of the Bluetooth Low Energy (BLE) beacons. Also, we formulate the problem as an optimization problem that serves as the Back-end of the algorithm mentioned above (Front-end). Thus, by simultaneously solving

for the robot trajectory and the map of BLE beacons, we recover a continuous and smooth trajectory of the robot, corrected locations of the BLE beacons, and the time-varying IMU bias. The evaluations achieved using hardware show that through the proposed closed-loop system the localization performance can be improved; furthermore, the system becomes robust to the error in the map of beacons by feeding back the optimized map to the Front-end.

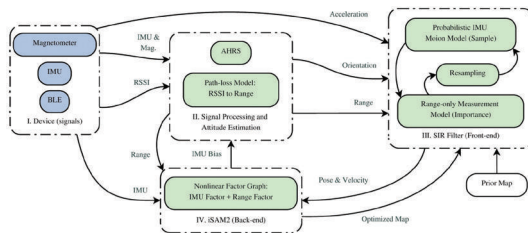

note book

## A6.1. SUPERVISED LEARNING FOR YAW ORIENTATION ESTIMATION

Tobias Feigl, Germany, tobias.feigl@fau.de - Christopher Mutschler, Germany  
Michael Philippsen, Germany

note book

**Key words:** Inertial sensor fusion, Head tracking, Machine learning, VR

With free movement and multi-user capabilities, there is demand to open up Virtual Reality (VR) for large spaces. However, the cost of accurate camera-based tracking grows with the size of the space and the number of users. No-pose (NP) tracking is cheaper, but so far it cannot accurately and stably estimate the yaw orientation of the user's head in the long-run.

Our novel yaw orientation estimation combines a single inertial sensor located at the human's head with inaccurate positional tracking. We exploit that humans tend to walk in their viewing direction and that they also tolerate some orientation drift. We classify head and body motion and estimate heading drift to enable low-cost long-time stable head orientation in NP tracking on 100m x 100m. Our evaluation shows that we estimate heading reasonably well.

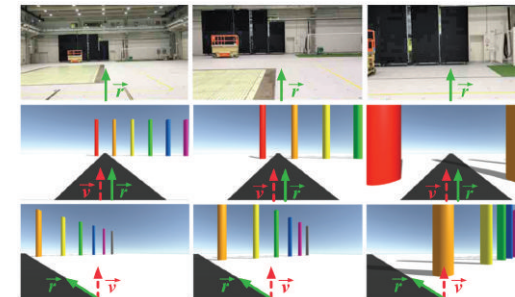

## A6.2. MULTIUSER POSITIONING WITH PARTICLE SWARM OPTIMIZATION IN 3GPP OUTDOOR SCENARIOS

Zhenyu Shi, China, zhenyu.shi@huawei.com  
Bin Hu, China, hubin24@huawei.com - Yi Wang, China, yi.wang@huawei.com

*Key words: Multiuser positioning, Particle swarm optimization, DOA, LTE*

Abstract: Accurately positioning user's location is an open problem in mobile communications. A novel positioning algorithm is presented for high resolution positioning. The approach adopts particle swarm optimization (PSO) for positioning based on the combination of time difference of arrival (TDOA) and direction of arrival (DOA) information. User-to-user (U2U) distance information

and filtering are utilized to further refine the position accuracy. Based on the long term evolution (LTE) deployment and the propagation channel model adopted in 3GPP Release 13, the performance of multiuser PSO positioning is investigated for outdoor network scenarios. Monte-Carlo simulation results show that the proposed PSO based method can improve the position accuracy by 7-8 times compared to the conventional LTE algorithm and it can deliver a lowest estimation error of 1.3m.

note  
book

## A6.3. COMPARISON OF ZADOFF-CHU ENCODED MODULATION SCHEMES IN AN ULTRASONIC LOCAL POSITIONING SYSTEM

Santiago Murano, Argentina, santiago.murano@edu.uah.es - M<sup>o</sup> Carmen Pérez, Spain, mcarmen.perezr@uah.es  
Chris J. Bleakley, Ireland - Jesús Ureña, Spain - Carlos De Marziani, Argentina

*Key words: Zadoff-Chu sequences, QPSK, OFDM, Frequency hopping, Ultrasound, Indoor position*

Ultrasonic Local Positioning Systems (U-LPS) can be used for fine-grained indoor positioning. Typically, multiple fixed beacons simultaneously emit ultrasonic signals whose time of arrival is estimated at a mobile receiver. The ultrasonic signals are encoded and modulated to allow separation of the signals at the receiver, identification of the transmitters, and mitigation of signal impairments such as multipath, the near-far effect, multiple access interference, and Doppler shift. Hence, waveform design (coding and modulation) plays a pivotal role in determining the performance of such a system. This paper compares the performance of four modulation techniques (specifically QPSK, OFDM, Slow-FHSS and Fast-FHSS) transmitting Zadoff-Chu (ZC) sequences in an U-LPS. The modulation schemes are evaluated in terms of time of arrival accuracy and

positioning accuracy in simulation and real-world experiments. Simulation and, to a lesser extent, real-world tests indicate that ZC coded QPSK modulation with non-coherent detection using a matched filter, offers greater accuracy under realistic conditions than the other modulation schemes.

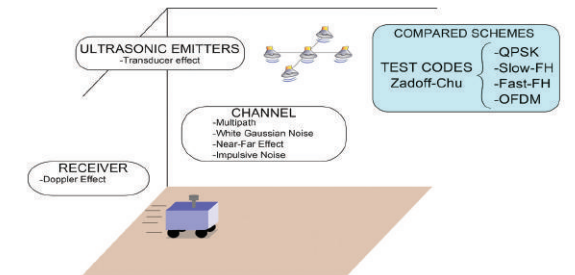

note  
book

## A6.4. NLOS DETECTION AND MITIGATION IN DIFFERENTIAL LOCALIZATION TOPOLOGIES BASED ON UWB DEVICES

Reza Zandian, Germany, zandian.reza@fh-swf.de  
 Ulf Witkowski, Germany, witkowski@fh-swf.de

**Key words:** Localization, TDoA, NLOS, UWB, Extended Kalman Filter, Probability Distribution Function

Ultra-wideband systems (UWB) are a common technology which is used for indoor localization applications due to its accuracy. However there are some challenges to implement these systems in indoor area with obstacles and barriers. One of the challenges is non-line of sight conditions (NLOS) between two communicating nodes which results in large localization error. Many techniques have been proposed in the literature for NLOS detection and mitigation but most of them are deployed in time of arrival (ToA) cases. This paper extends the NLOS detection and mitigation techniques to time difference of arrival cases (TDoA). The proposed method is a parametric technique based on the probability distribution function (PDF) of features collected from received signal characteristics. An innovative method is used to apply the parametric detection method on TDoA cases both in detection and mitigation stages.

The mitigation technique is based on a modified and biased extended Kalman filter (BEKF) which is used in TDoA localization method. The results prove that this technique successfully detects the NLOS cases, mitigates the error up to a factor of 10 and leads to stability of the EKF method.

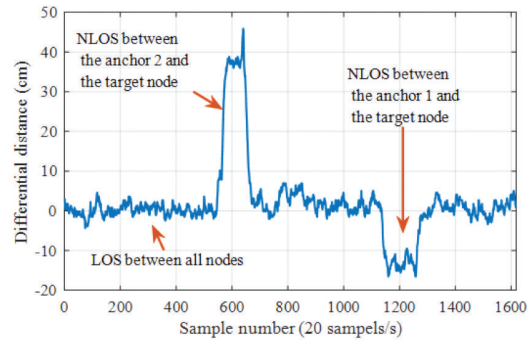

note book

## A7.1. EVALUATION OF INDOOR LOCALISATION SYSTEMS: COMMENTS ON THE ISO/IEC 18305 STANDARD

Francesco Potorti, Italy, Potorti@isi.cnr.it  
 Antonino Crivello, Italy - Paolo Barsocchi, Italy - Filippo Palumbo, Italy

**Key words:** Performance evaluation, Indoor localisation systems, ISO/IEC 18305:2016, IPIN-ISC

Indoor localisation systems have been studied in the literature for more than ten years and are starting to approach the market. The absence of standard evaluation methods is one of the obstacles to their adoption outside of customised environments.

Specifically, the definition of benchmarking methodologies, common evaluation criteria, standardised methodologies useful to developers, testers, and end users is an open challenge.

The need for common benchmarks has been tackled by some initiatives in recent years: EvAAL, EVARILOS, the Microsoft competition and the IPIN competition. The first formal attempt at defining a standard methodology to evaluate indoor localisation systems is the ISO/IEC 18305:2016 International Standard, which defines a complete framework for performing Test&Evaluation of localisation and tracking systems.

This work is a first critical reading of the standard, intended to be a key contribution to the activities of the International Standards Committee of IPIN.

note book

POSSIBLE DEFINITIONS OF SCALAR ERROR

Method	Ease of measurement	Usefulness	References
3D Euclidean distance	Very high: requires coordinates and at most coordinate conversion	Low: vertical errors have the same weight as horizontal errors, which means overestimating their importance if less than floor height and grossly underestimating it if greater than that	Used in the standard under review and almost universally in the literature
2D Euclidean distance with floor penalty	High: requires floor estimate which is available anyway, and little more complication than the above	Medium: floor errors are accounted for, but the penalty is somehow arbitrary; horizontal obstacles like walls are not accounted for	The standard error definition for the IPIN competitions 2014-2018 [8]
Real distance	Low: requires accurate maps and appropriate implementation	High: estimates the length of the distance to be walked from the estimate to the ground truth	This metric is described in detail in [18] and is a candidate for use in the IPIN 2019 competition

## A7.2. EVALUATION CRITERIA FOR INSIDE-OUT INDOOR POSITIONING SYSTEMS BASED ON MACHINE LEARNING

Christoffer Löffler, Germany, christoffer.loeffler@iis.fraunhofer.de  
 Sascha Riechel, Germany - Janina Fischer, Germany - Christopher Mutschler, Germany

**Key words:** *Self-positioning, Fingerprinting, Optical systems, Testing methodology*

Real-time tracking allows to trace goods and enables the optimization of logistics processes in many application areas. Camera-based inside-out tracking that uses



an infrastructure of fixed and known markers is costly as the markers need to be installed and maintained in the environment. Instead, systems that use natural markers suffer from changes in the physical environment. Recently a number of approaches based on machine learning (ML) aim to address such issues.

This paper proposes evaluation criteria that consider algorithmic properties of ML-based positioning schemes and introduces a dataset from an indoor warehouse scenario to evaluate for them. Our dataset consists of images labeled with millimeter precise positions that allows for a better development and performance evaluation of learning algorithms. This allows an evaluation of machine learning algorithms for monocular optical positioning in a realistic indoor position application for the first time. We also show the feasibility of ML-based positioning schemes for an industrial deployment.

note  
book

## A7.3. AN ANALYTICAL STUDY OF TIME OF FLIGHT ERROR ESTIMATION IN TWO-WAY RANGING METHODS

Cung Lian Sang, csang@techfak.uni-bielefeld.de  
 Michael Adams - Timm Hörmann - Marc Hesse - Mario Pormann - Ulrich Rückert

**Key words:** *Time of flight (TOF), Two way ranging (TWR), Analytical model, TOF error model, Time of arrival (TOA), Time based ranging techniques, Indoor positioning*

note  
book

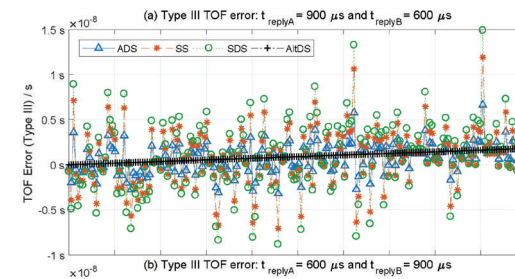

In absence of clock synchronization, Two-Way Ranging (TWR) is the most commonly used technique for measuring the distance between two wireless transceivers. The existing time-of-flight (TOF) error estimation model, the IEEE 802.15.4-2011 standard, is specifically based on clock drift error. However, it is insufficient when an in-depth comparative analysis of different TWR methods is required. In this paper, we propose an extended TOF error estimation model for TWR methods, based on the IEEE 802.15.4 standard. Using the proposed model, we perform an analytical study of TOF error estimation among different TWR methods. The model is validated with numerical simulation results. Moreover, we demonstrate the pitfalls of the symmetric double-sided TWR (SDS-TWR) method, which is commonly used to reduce the TOF error due to clock drifts.

## A7.4. CHARACTERIZATION OF MULTIPATH EFFECTS IN INDOOR POSITIONING SYSTEMS BASED ON INFRARED SIGNALS

Álvaro De-La-Llana-Calvo, alvaro.llana@uah.es, josel.lazaro - José Luis Lázaro-Galilea  
 Alfredo Gardel-Vicente, alfredo.gardel@uah.es - David Rodríguez-Navarro, david.rodriguez@uah.es  
 Ignacio Bravo-Muñoz, ignacio.bravo@uah.es  
 Department of electronics, University of Alcalá, Alcalá de Henares, Spain

**Key words:** *Multipath, Indoor positioning, Optical signal, PSD sensor, Light positioning, Infrared*

This work presents advances in the characterization of multipath (MP) effects in Indoor Positioning Systems (IPS) using Position Sensitive Devices (PSD). The positioning errors introduced by MP are characterized while determining the Angle of Arrival (AoA) of an infrared signal (IR) to the PSD detector. From the obtained results it can be concluded that the MP effects in the positioning using AoA on PSDs have a reduced impact on the measurements.

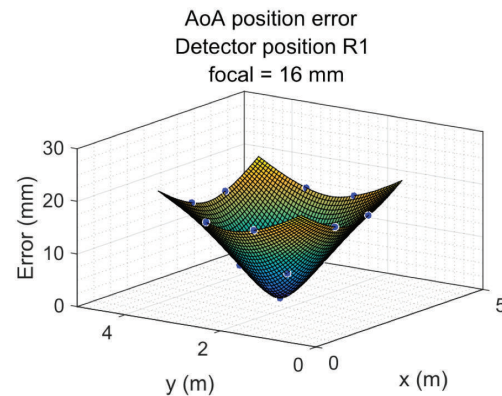

note  
book

## A7.5. DISTRIBUTED COORDINATION, TRANSPORTATION & LOCALISATION IN INDUSTRY 4.0

Ruben Van Parys, Belgium - Maarten Verbandt, Belgium, maarten.verbandt@kuleuven.be - Marcus Kotzé, Belgium  
 Peter Coppens, Belgium - Jan Swevers, Belgium - Herman Bruyninckx, Belgium - Johan Philips, Belgium - Goele Pipeleers, Belgium

**Key words:** *Industry 4.0, Indoor localisation, Optimal motion planning, Holonic coordination, Distributed systems, Experimental validation*

Factories of the future must be agile to adapt to rapidly changing customer needs, market volatility and shortened product life cycles. This requires flexibility in hardware and software at distinct levels of the factory and manufacturing process: multipurpose machines with fast change-overs, easy to use reconfigurable software and distributed decision-making are key. This paper leverages the new Industry 4.0 design principles to cope with these new manufacturing requirements: (i) distributed auction-based coordination allows local decision-making and task allocation, (ii) distributed model predictive control-based transportation enables free space collision avoidance of automated guided vehicles (AGVs), and (iii) distributed vision-based localisation provides scalable and dynamic position information of key resources on the factory floor. Furthermore, these contributions are brought together in a lab-scale reconfigurable manufacturing system to showcase modularity and distributed decision-making at several levels of a manufacturing process' logistics.

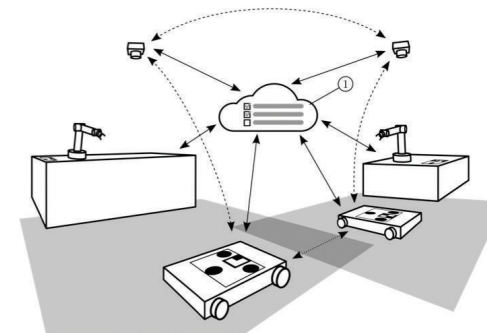

note  
book



# B1.1. CDM: COMPOUND DISSIMILARITY MEASURE AND AN APPLICATION TO FINGERPRINTING-BASED POSITIONING

Caifa Zhou, Switzerland, caifa.zhou@geod.baug.ethz.ch  
 Andreas Wieser, Switzerland, andreas.wieser@geod.baug.ethz.ch

**Key words:** Compound dissimilarity measure (CDM), Nonvector-based dissimilarity measure, Fingerprinting-based positioning, kNN

A non-vector-based dissimilarity measure is proposed by combining vector-based distance metrics and set operations. This proposed compound dissimilarity measure (CDM) is applicable to quantify the similarity of collections of attribute/feature pairs where not all attributes are present in all collections. This is a typical challenge in the context of e.g., fingerprinting-based positioning

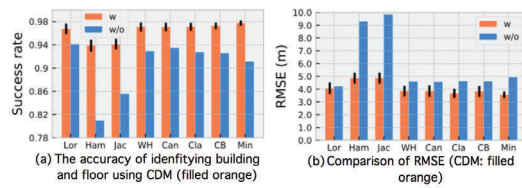

(FbP). Compared to vector-based distance metrics (e.g., Minkowski), the merits of the proposed CDM are i) the data do not need to be converted to vectors of equal dimension, ii) shared and unshared attributes can be weighted differently within the assessment, and iii) additional degrees of freedom within the measure allow to adapt its properties to application needs in a data-driven way.

We indicate the validity of the proposed CDM by demonstrating the improvements of the positioning performance of fingerprinting-based WLAN indoor positioning using four different datasets, three of them publicly available. When processing these datasets using CDM instead of conventional distance metrics the accuracy of identifying buildings and floors improves by about 5% on average. The 2d positioning errors in terms of root mean squared error (RMSE) are reduced by a factor of two, and the percentage of position solutions with less than 2m error improves by over 10%.

note book

# B1.2. DELFIN: A DEEP LEARNING BASED CSI FINGERPRINTING INDOOR LOCALIZATION IN IOT CONTEXT

Brieuc Berruet, France, brieuc.berruet@utbm.fr - Oumaya Baala, France, oumaya.baala@utbm.fr  
 Alexandre Caminada, France, alexandre.caminada@utbm.fr - Valéry Guillet, France, valery.guillet@orange.com

**Key words:** Fingerprinting, Channel State Information, Deep Learning, Internet of Things

Many applications in Internet of Things (IoT) require an ubiquitous localization to provide their services. Whereas the global navigation satellite systems are mainly used in outdoor environment, multiple solutions based on mobile sensors or wireless communication infrastructures exist for indoor localization. One of them is the fingerprinting approach which consists in collecting the signals at known locations in a studied area and estimating the locations of new incoming signals thanks to the collected database. This approach interests many researchers due to its connection with machine learning concepts. In this paper we propose to implement a deep learning architecture for a fingerprinting localization based on Wi-Fi channel frequency responses in IoT context. Our solution, DelFin reduces the median and 90-th percentile localization errors up to 50% and 47% respectively compared to other fingerprinting methods. DelFin has been tested with different spatial distributions of training locations in the studied area and still performed the best results.

note book

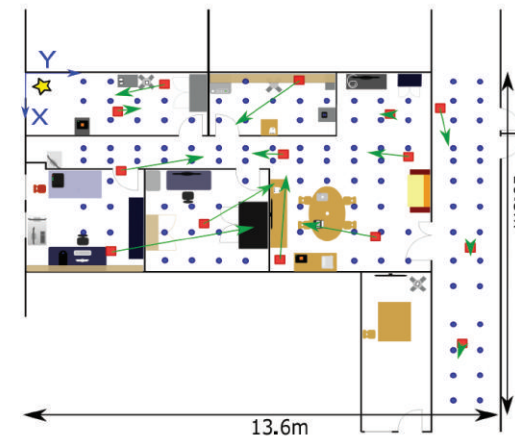

## B1.3. A NEW METHODOLOGY FOR LONG-TERM MAINTENANCE OF WIFI FINGERPRINTING RADIO MAPS

R. Montoliu, E. Sansano, O. Belmonte, J. Torres-Sospedra

*Key words: WiFi fingerprinting, Radio map maintenance, Missing data, Imputation by regression*

One of the main problems of Indoor Positioning Systems (IPSs) based on WiFi fingerprinting is the radio map maintenance. It is well known that the creation of the radio map is a tedious and long-time task. In addition, if sometime after its creation, some access points are removed from the environment the accuracy of the

IPS can be dramatically affected. This paper presents a new methodology to deal with this problem using imputation based techniques. An extensive set of experiments, comparing different imputation techniques, has been performed to demonstrate the benefits of using the proposed approach, showing that the proposed method is able to reduce the localization error in almost one meter with respect to a well-known solution.

note  
book

## B1.4. SIGNAL FINGERPRINT ANOMALY DETECTION FOR PROBABILISTIC INDOOR POSITIONING

Ran Guan, UK, ran.guan@cl.cam.ac.uk  
Robert Harle, UK, robert.harle@cl.cam.ac.uk

*Key words: Indoor positioning, Fingerprinting, Error Estimates, Localisation*

Signal fingerprinting is considered to be potential as the general indoor positioning solution since it does not require extra infrastructure or hardware modification to current customer smart devices. However, due to the complex nature of radio signal propagation, fingerprints are highly susceptible to both temporal and spatial indoor dynamics, rendering the positioning outcomes unreliable. Most

recent works dedicated to efficient ways of building radio maps during the offline phase yet overlooked the localisability of fingerprints collected rather opportunistically at the online phase. In this paper, we introduce the use of pseudo-measurements and propose a fingerprint anomaly detection method that effectively evaluates the localisability of fingerprints while positioning. Empirical evaluations demonstrate that filtering out untrustworthy fingerprints can significantly improve the positioning accuracy.

note  
book

## B1.5. WIFI FINGERPRINTING LOCALIZATION FOR INTELLIGENT VEHICLES IN CAR PARK

Dinh-Van Nguyen, France, dinh-van.nguyen@inria.fr

Raoul de Charette, France - Fawzi Nashashibi, France - Trung-Kien Dao, Vietnam - Eric Castell, Vietnam

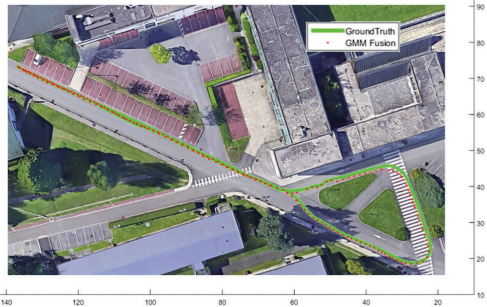

**Key words:** Intelligent Vehicles localization, WiFi Fingerprinting, Neural Network, Particle Filter

In this paper, a novel method of WiFi fingerprinting for localizing intelligent vehicles in GPS-denied area, such as car parks, is proposed. Although the method itself is a popular approach for indoor localization application, adapting it to the speed of vehicles requires different treatment. By deploying an ensemble neural network for fingerprinting classification, the method shows a reasonable localization precision at car park speed. Furthermore, a Gaussian Mixture Model (GMM) Particle Filter is applied to increase localization frequency as well as accuracy. Experiments show promising results with average localization error of 0.6m.

note  
book

## B2.1. SAR-BASED INDOOR LOCALIZATION OF UHF-RFID TAGS VIA MOBILE ROBOT

Andrea Motroni, Italy, andrea.motroni@ing.unipi.it

Paolo Nepa, Italy - Valerio Magnago, Italy - Alice Buffi, Italy - Bernardo Tellini, Italy - Daniele Fontanelli, Italy - David Macii, Italy

note  
book

**Key words:** UHF-RFID Localization, RFID robot, Moving RFID reader, Tag indoor positioning, RFID Warehouse Localization

This paper presents a localization method exploiting a mobile robot equipped with an Ultra High Frequency Radio Frequency IDentification (UHF-RFID) reader to locate stationary tags in warehouse scenarios. The measurement method is based on the Synthetic Aperture Radar (SAR) approach and the robot trajectory knowledge is achieved through a calibrated vision-based system suitable for indoor environments. The technique capability is demonstrated through an experimental analysis employing commercial UHF-RFID hardware and a wheeled robot. Localization accuracy is evaluated on the field by using a calibrated vision system, used to both locate the robotic vehicle and the tags when detected.

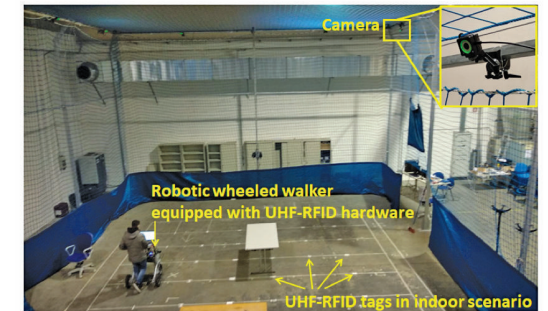

## B2.2. VISION-BASED INDOOR POSITIONING OF A ROBOTIC VEHICLE WITH A FLOORPLAN

John Noonan, Israel, john.noonan@cs.technion.ac.il  
Hector Rotstein, Israel - Amir Geva, Israel - Ehud Rivlin, Israel

*Key words: Indoor Positioning, Robotic Vehicle, Vision-Based Navigation, Floorplan*

This paper presents a vision-based indoor positioning system of a small robotic vehicle utilizing knowledge of the building floorplan. Using images taken by a monocular camera rigidly mounted onto the deck of the vehicle, the localization system obtains initial geometry of the environment and camera motion by running Structure from Motion. The localization system resolves the scale ambiguity present in the data by associating planar structures in the 3D point cloud with walls of the building. In order to extract the planes, we developed a Scale Invariant Planar RANSAC (SIPR) algorithm which handles situations of scale ambiguity in the point cloud data. Our Wall Plane Fusion algorithm forms correspondences between walls and computed planes, and the best such correspondence is used as an external

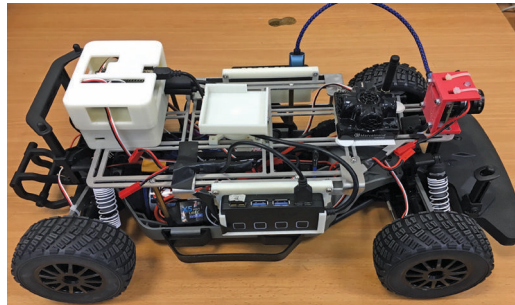

constraint to the Bundle Adjustment algorithm which is run on the Structure from Motion data. A necessary condition for providing a global positioning solution is that one wall be in view. This paper provides results in both simulated and real-world scenarios.

note  
book

## B2.3. LIGHTWEIGHT LINE FEATURES FOR INDOOR CAMERA POSE ESTIMATION

Amir Geva, Israel, amirgeva@cs.technion.ac.il  
Hector Rotstein, Israel, hector@ee.technion.ac.il

*Key words: Indoor Localization, Vision, QuadCopter, Navigation*

Pose estimation in an indoor environment is of utmost importance for robotic applications. With the absence of a ubiquitous GPS alternative, vision based methods become the go-to approach. This paper introduces a light-weight method for orientation and position estimation from a single frame based on typical indoor architectural features. This method can be used in an autonomous micro aerial vehicle to navigate in real-time with a limited on board processor.



note  
book

## B2.4. REAL-TIME LOCALIZATION AND TRACKING USING VISIBLE LIGHT COMMUNICATION

Márk Rátosi, Hungary, ratosi@dcs.uni-pannon.hu  
Gyula Simon, Hungary

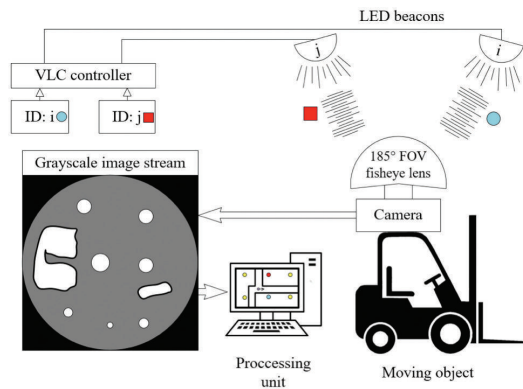

note  
book

**Key words:** Indoor positioning, VLC, Fisheye, Real-time tracking, Heuristic data fusion

In this paper an optical indoor positioning system is proposed, which utilizes modulated LED lights as anchor points, deployed in known positions. The sensor, deployed on the tracked object (e.g. autonomous vehicle), is an ordinary camera facing upwards. The system is able to estimate the position and orientation of the moving object in real-time, based on the camera's image stream, containing images of the anchor points. The paper contains comprehensive analysis on the possible error sources and their effect on the positioning accuracy. Real measurement tests show that the accuracy of the system is in the low centimeter range even if the tracked camera moves with a speed of 1m/s.

## B2.5. EIRIS - AN EXTENDED PROPOSITION USING MODIFIED OCCUPANCY GRID MAP AND PROPER SEEDING

Arup Kumar Sadhu, India, arupk.sadhu@tcs.com  
Ranjan Dasgupta, India, ranjan.dasgupta@tcs.com - P Balamuralidhar, India, balamurali.p@tcs.com

**Key words:** EIRIS, Free-space, Convex hull, Proper seeding, Guided iterative inflation

With a view of robotic path planning inside any cluttered and confined indoor environment, a-priori generation of convex free-spaces offers additional benefit to the motion planner. Traditionally the convex free-space grows from a seed, which either selected randomly or generated from a heuristic function. However arbitrary seeding cannot guarantee maximal free-space coverage. In addition, improper seeding may ignore a valuable free-space information (e.g., narrow corridor, broken window, partially closed door etc.), because of which planning might fail. In the current work, a logically Extended Iterative Regional Inflation by Semidefinite Programming (EIRIS) is proposed to address the problem. A modified occupancy grid map (MOGM) creates an approximate binary map of the environment. It is thereby used to identify the mutually isolated largest possible free-regions. For each free-region proper seeding (PS) algorithm allows the generated seed to inflate along a coordinate axis. Unlike IRIS where unguided growth results in random free-space generation,

the greedy expansion of a seed is inhibited temporarily by treating all the free-regions as virtual obstacles other than the region of interest. It is a guided iterative inflation (GII) algorithm. Regarding robotic path planning the convex free-space information needs to be contiguous and subsequently traditional graph search technique can be exploited for efficient path generation. But it is beyond the scope of present discussion and considered as a future work. However few typical paths are shown in the paper to emphasize the utility of free-space generation in prior of path planning. Simulation results with empirical analysis establish the improvement of proposed method (EIRIS) over the state-of-the-art approach.

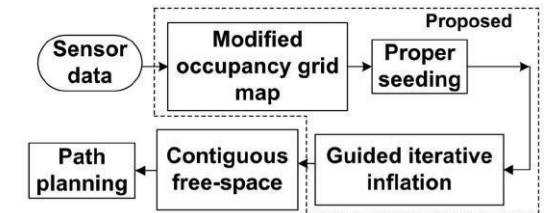

note  
book

## B2.6. MODEL BASED DRIFT-FREE LOCALIZATION FOR MULTIROTORS

Vishvendra Rustagi, India, vi.rus@tcs.com  
 Mohit Ludhiyani, India, mohit.ludhiyani@tcs.com  
 Arnab Sinha, India - Ranjan Dasgupta, India

**Key words:** State Estimation, Scale, Localisation, Filter, Dynamics Model

This paper presents a novel method to eliminate drift for dynamics model based localization of multirotors. The dynamics equations require drag modelling, which is dependent on velocity, to generate vehicles's acceleration along the body axis.

It is shown in this paper that the drag contribution, at velocity level, can be treated as a low frequency component. Incorrect or nonmodelling of this low frequency component leads to drift at velocity level. This drift can then be removed through a high pass filter.

Experiments are performed on an AR.Drone quadrotor

platform and results validated using motion capture camera system. The obtained results demonstrate that treating drag in the said manner leads to drift free velocity and hence to better localization. Further, it is shown that this approach could be exploited to extract scale information solely from a monocular camera

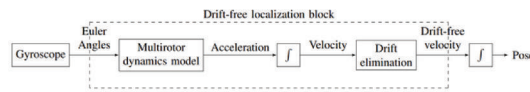

Fig. 1: Pose estimation methodology

note book

## B3.1. A BAYESIAN APPROACH TO DEALING WITH DEVICE HETEROGENEITY IN AN INDOOR POSITIONING SYSTEM

Kyle F. Davies, UK, kyle.davies@manchester.ac.uk  
 Ian G. Jones, UK - Jonathan L. Shapiro, UK

**Key words:** Indoor Localization, Bayesian modelling, Received signal strength (RSS)

There are many practical applications in which the ability to localize devices such as phones, tablets, and mobile equipment is important. One of the issues which makes this difficult is the fact that devices are all different, so an approach which is robust against device heterogeneity would be an advance. In this paper, a method for estimating the positions of transmitting devices using Wi-Fi and a network of access points (APs) is proposed and investigated. The APs can also function as transmitters; as such the method allows simultaneous calibration and localization, so no fingerprinting or separate calibration is required. A hierarchical Bayesian probabilistic model is used with separate but conditionally-related parameters for each transmitter and receiver to tackle the device inhomogeneity problem. The output is a probability distribution over the location of each device from which the expected location and measures of uncertainty in location can be obtained. The system was implemented in an office environment using heterogeneous transmitters and receivers. The system localized the devices with a median error of 1.7 meters and within 4.32 meters with 95% confidence. We discovered that it is more important to account for inhomogeneity in the transmitters than in the receivers. Removing the former from the model results in a median error of 6.57m (10.56m) whereas removing the latter results in a median error 1.93m (4.64m). We argue that the technique could be used to cope with other types of inhomogeneities in the environments or the Wi-Fi equipment.

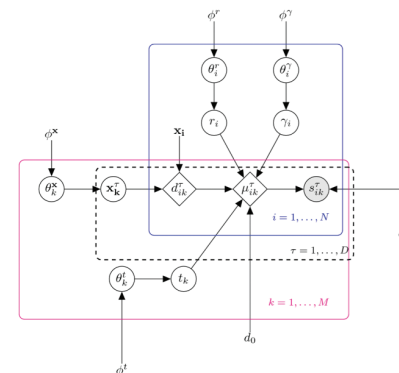

note book

## B3.2. NEURAL NETWORK BASED RADIO FINGERPRINT SIMILARITY MEASURE

Boxian Dong, Austria, boxian@indoo.rs  
 Thomas Burgess, Austria - Hans-Berndt Neuner, Austria - Susanne Fercher, Austria

**Key words:** Indoor navigation, RSSI, Footrule, Localization, Deep learning, Neural network, Bluetooth, Calibration

The radio signal Received Signal Strength Indicator (RSSI) based localization method is one of the most often adopted indoors localization methods, due to the fact that it can be used by any handheld devices on the market without any modification. This paper will present a new deep learning inspired model to predict locational distance/similarity between two points based on their RSSI measurement. This model uses carefully designed input features, neural network architecture, as well as purposely crafted pre-training to combine the features and statistics from multiple hand crafted RSSI to locational similarity models (reference models). The reference models include a RSSI difference based model (Euclidean distance), number of visible signals by both measurements (Jaccard distance) and the rank difference of commonly visible signals in the comparing measurements (Spearman's footrule). Our evaluation shows the three reference models have very distinct strengths and weaknesses: the Euclidean distance based model generates the most detailed prediction and has best estimation results when the two measurement points are close to each other; the

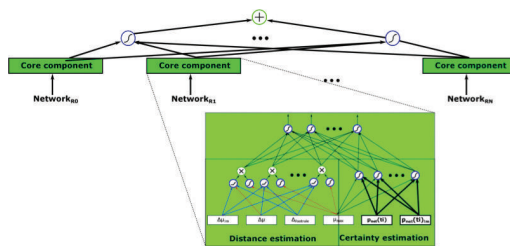

Jaccard distance based model can only provide a very coarse estimation, however, it can distinct points that are far away; the Spearman's footrule based solution has overall good but coarse estimation, and its estimations represent the relative distance very well, especially in the middle range. The proposed method, as we expected, combines the best features from all three reference models and generates the best locational distance estimation.

note  
book

## B3.3. UNSUPERVISED DEEP FEATURE LEARNING TO REDUCE THE COLLECTION OF FINGERPRINTS FOR INDOOR LOCALIZATION USING DEEP BELIEF NETWORKS

Duc V. Le, Nirvana Meratnia, The Netherlands, v.d.le@utwente.nl - Paul J. M. Havinga, The Netherlands

note  
book

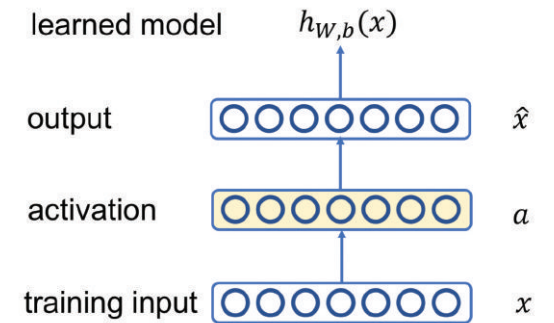

**Key words:** WLAN-fingerprint based localization, Unsupervised deep feature learning, Indoor localization, Fingerprint reduction, Deep belief network

One of the most practical localization techniques is WLAN-based fingerprinting for location-based services because of the availability of WLAN Access Points (APs). This technique measures the Received Signal Strength (RSS) from APs at each indicated location to construct fingerprints. However, the collection of fingerprints is notoriously laborious and needs to be repeatedly updated due to the changes of environments. To reduce the workload of fingerprinting, we apply Deep Belief Networks to unlabeled RSS measurements to extract hidden features of the fingerprints, and thereby minimize the collection of fingerprints. These features are used as inputs for conventional regression techniques such as Support Vector Machine and K-Nearest Neighbors. The experiment results show that our feature representations learned from unlabeled fingerprints provide better performance for indoor localization than baseline approaches with a small fraction of labeled fingerprints traditionally used. In the experiment, our approach already improves the localization accuracy by 1.9 m when using only 10% of labeled fingerprints, compared to the closest baseline approach which used 100% of labeled fingerprints.

## B3.4. PASSIVE WI-FI FINGERPRINTING METHOD

Jaewon Kim, Korea, dds�han@kaist.ac.kr - Dongsoo Han, Korea

*Key words: Signal Strength Based Methods, Fingerprinting*

WiFi fingerprinting methods are widely used in indoor positioning field, but it requires time and efforts to collect fingerprints. Crowdsourcing techniques have been actively studied to reduce the collection cost, but it still needs user's explicit involvement such as installing and operating an application. In this paper, we propose a network

fingerprinting method without the explicit involvement. it collects unlabeled fingerprints including received signal strength(RSS) of probe request message(PRqM) by multiple APs. After collecting the fingerprints, we perform singular vector decomposition(SVD), latent semantic analysis(LSA) and location optimization to construct radio map. The proposed method achieved 2.93m accuracy of radio map and 3.72m accuracy of positioning.

note  
book

## B4.1. EXPERIMENTAL EVALUATION OF THE PLANAR ASSUMPTION IN MAGNETIC POSITIONING

David Hanley, USA, hanley6@illinois.edu - Xiangyuan Zhang, USA  
Augusto S. Dantas de Oliveira, USA - Daniel Steinberg, USA - Timothy Bretl, USA

*Key words: Magnetic Localization, Magnetometers, Three-Dimensional Magnetic Field Analysis*

In this paper, we confirm the hypothesis that the magnetic field inside a building can vary significantly as a function of height. We collected data with twenty magnetometers spaced evenly from knee height to head height and mounted to a ground robot, which we drove through two different buildings on the campus of the University of Illinois at Urbana-Champaign. We applied Gaussian process regression to build a map of the magnetic field at each height. We compared these maps and saw pairwise differences of more than in up to 20% of each test environment, a threshold that we argue would prevent meeting the requirements of common indoor positioning applications. These results call into question the planar assumption that is commonly made when deriving methods of indoor position that are based on the use of magnetic fields.

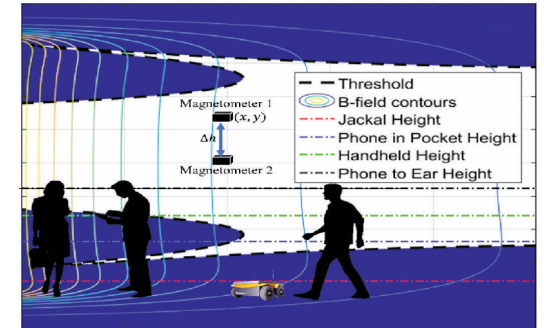

note  
book



## B4.2. ROTATION-INVARIANT MAGNETIC FEATURES FOR INERTIAL INDOOR-LOCALIZATION

Konstantin Klipp, Germany, konstantin.klipp@tu-berlin.de  
Helge Rosé, Germany - Jonas Willaredt, Germany - Oliver Sawade, Germany - Ilja Radusch, Germany

*Key words: Indoor Navigation, Smartphone, Magnetic, Inertial Sensors, Sensor Fusion*

Indoor-Localization using mobile end-user devices such as smartphones remains a highly discussed research topic. Applications range from guidance in large structures, assistance of visually impaired or even localization and guidance in rescue operations. Current approaches are often based on Radio-Frequency strength localization, which show insufficient precision and robustness. In this paper we investigate a magnetobased approach using rotation-invariant features compared with a pre-recorded grid-based map. Furthermore, we show, how this approach can be combined with relative localization using step recognition from inertial measurements. We test and evaluate both systems in simulation as well as

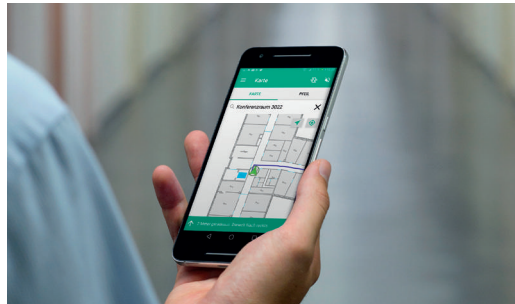

real-world tests. We show, that a sub-meter precision localization accuracy can be reached using our magnetoinertial approach.

note book

## B4.3. MAGNETIC FIELD AS A CHARACTERIZATION OF WIDE AND NARROW SPACES IN A REAL CHALLENGING SCENARIO USING DYNAMIC TIME WARPING

Antoni Perez-Navarro, Spain, aperezn@uoc.edu - Raul Montoliu, Spain - Joaquín Torres-Sospoldra, Spain - Jordi Conesa, Spain

*Key words: Magnetic field, Indoor Positioning, Proof of Concept, Challenging Scenarios, DTW*

This paper presents a study of indoor positioning in public zones of the Parc Taulí Hospital in Sabadell. It is a challenging scenario because: 1) it combines wide spaces with middle sized and narrow spaces; 2) it is a shielded zone where no signals are available, and therefore, no WiFi signal can be used for positioning; and 3) it is not possible to deploy beacons for positioning. The goal of this work is to test whether it is possible to get indoor positioning in a real and challenging scenario by using only the magnetic field. The positioning precision requires to locate the part of the hospital where the user is. The proposed solution defines “virtual corridors” to improve positioning in wide areas. To validate the work, magnetic field data have been recorded from the scenario, using different smartphones and by different persons. The obtained magnetic data curves have been compared by using Dynamic Time Warping (DTW) distance. Results show that it is possible to characterize every path with the magnetic field. The main contributions of the present paper are: 1) defining “virtual corridors” as a way to position using magnetic field in 2D spaces; and 2) showing that even in wide spaces, like the hall of a hospital, it is possible to find magnetic anomalies linked to positions.

note book

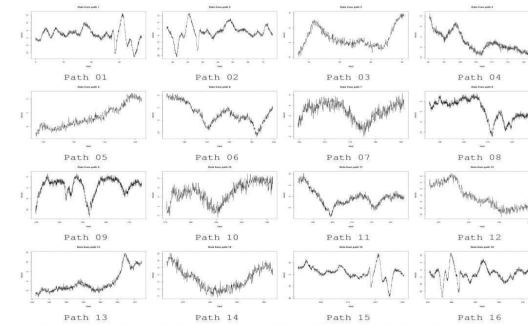

## B4.4. CROWDSOURCING-BASED MAGNETIC MAP GENERATION FOR INDOOR LOCALIZATION

Akin Ayanoglu, Germany, akin\_ayanoglu@hotmail.de - Daniel M. Schneider, Germany, daniel.schneider@sony.com  
Ben Eitel, Germany, ben.eitel@sony.com

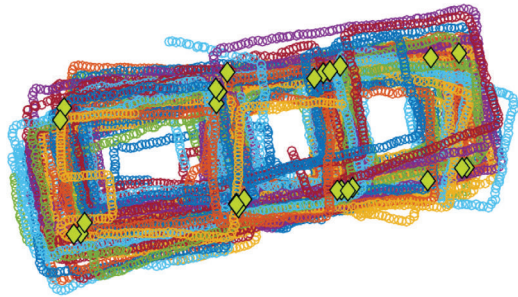

note  
book

**Key words:** Indoor mapping, Automatic map generation, Crowdsourcing, Magnetic fingerprinting

We propose an automatic map construction algorithm that assembles many users' trajectories to a FingerPrinting (FP) map of an indoor environment. Our crowdsourcing approach uses only the inertial sensors of mobile devices, neither dedicated infrastructure nor floor plan information is required. We identify overlapping segments of the trajectories, which are obtained by a simple pedestrian dead reckoning algorithm, by clustering magnetic and heading features. These clusters are used as landmarks in a novel geometric map construction process. Finally, the FP map is derived from the geometric map by exploiting the recorded sensor data of the individual trajectories. Initial results of recordings in a typical office environment show that the algorithm is able to construct a magnetic FP map which closely matches a manually generated magnetic map.

## B4.5. IMPROVED INDOOR GEOMAGNETIC FIELD FINGERPRINTING FOR SMARTWATCH LOCALIZATION USING DEEP LEARNING

Fahad Al-homayani, USA, fahad.al-homayani@du.edu  
Mohammad Mahoor, USA

**Key words:** Geomagnetic field, Fingerprinting, Deep learning, Smartwatch

Geomagnetic field fingerprinting has attracted researchers in recent years as a promising alternative to WiFi and Bluetooth fingerprinting. It is omnipresent, stable, and does not require the deployment of specialized infrastructure to be realized. While several studies have utilized these characteristics in developing indoor positioning systems, the positioning accuracy still can be improved. This paper presents a Convolutional Neural Network (CNN) based method for designing and developing a novel smartwatch-based indoor geomagnetic field positioning system. We tested the proposed system on real world data in an indoor environment composed of three corridors of different lengths and three rooms of different sizes. Experimental results show a promising location classification accuracy of 97.77% with a mean



localization error of 0.136 meters. We also demonstrate how the Softmax (SM) layer of the network can be exploited to further improve the localization accuracy in user tracking scenarios.

note  
book

## B5.1. CHARACTERISING THE ALTERATION IN THE AP DISTRIBUTION WITH THE RSS DISTANCE AND THE POSITION ESTIMATES

Joaquín Torres-Sospedra, Spain, jtorres@uji.es

Philipp Richter - Germán Mendoza-Silva - Elena Simona Lohan - Joaquín Huerta, Spain and Finland

note  
book

**Key words:** *Wi-Fi Fingerprinting, Spatial Analysis, Fault Detection*

Fingerprinting is widely used for indoor positioning, where pattern matching techniques are usually applied to signals from APs or Beacons. However, the real-time monitoring of the emitters is not an easy task in most cases. When an alteration in the emitters is not detected or properly fixed, it might have a severe impact in the accuracy of the indoor positioning algorithm. Simple but common alterations are energy failure, emitter replacement, wrong emitter placement after maintenance and AP displacement. This paper explores how the AP alteration might be automatically detected by computing the average of the RSS distance to the best match over multiple operational points. The experimental setup consider one simulated and two real scenarios to validate the proposed metric for detecting AP alteration. The results show that it is possible to detect AP alteration when it has a considerable impact in the IPS accuracy.

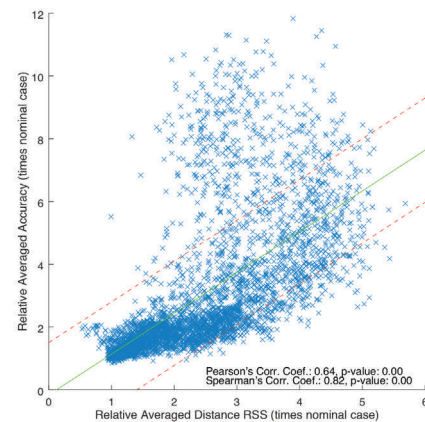

## B5.2. RSS-BASED DOA / DOD ESTIMATION USING BLUETOOTH SIGNAL AND ITS APPLICATION FOR INDOOR TRACKING

Naoki Honma, Japan, honma@iwate-u.ac.jp

Ryota Tazawa, Japan - Atsushi Miura, Japan - Yusuke Sugawara, Japan - Hiroto Minamizawa, Japan

note  
book

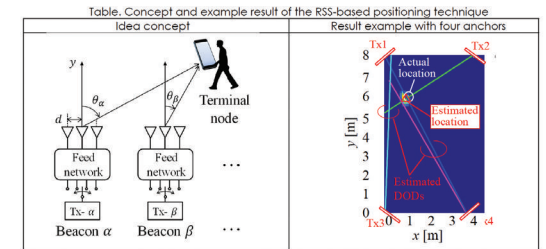

**Key words:** *RSS, Direction-of-departure, Array Antenna, Bluetooth, Tracking*

This paper studies a tracking performance of the positioning technique using RSS-based direction of departure/arrival (DOD / DOA) estimation. The multiple DOD beacons are fabricated and deployed in a middle-sized meeting room, and Bluetooth signal was used so as that the commercially available smartphone can receive the beacon signals and estimates its location. The measurement results reveal that the RSS-based DOD beacons realize high accuracy in positioning even for the moving terminal node; the DOD estimation accuracy was 6.7°~ 9.1°, and positioning accuracy was 0.65m ~ 0.86m at 50 percentile.

## B5.3. A METHOD OF RADIO MAP CONSTRUCTION BASED ON CROWDSOURCING AND INTERPOLATION FOR WI-FI POSITIONING SYSTEM

Jingxue Bi, China, bix1050@163.com - Yunjia Wang, China, wyjc411@163.com - Hongji Cao, China, 2685040723@qq.com  
Hongxia Qi, China - Keqiang Liu, China - Shenglei Xu, China

**Key words:** Radio map, Crowdsourcing, Interpolation, Inverse distance weighted, Device heterogeneity, Normalization, Principal component analysis, Dimensionality reduction

Wi-Fi indoor positioning has attracted a great deal of attention in recent years. Received signal strength (RSS)-based fingerprinting localization method may be the simplest and most efficient one. The radio map construction

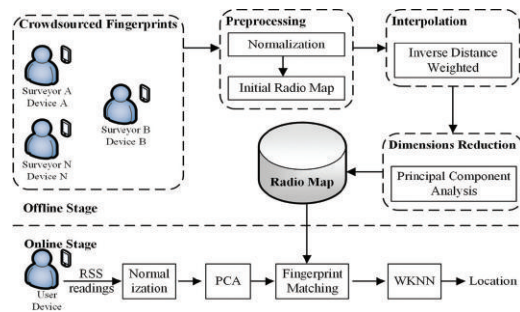

is time-consuming and labor-sensitive, hindering the wide use of RSS-based fingerprinting localization. Therefore, we propose a method of radio map construction based on crowdsourcing and interpolation for Wi-Fi indoor positioning system. First of all, fingerprints at a small number of refer points are collected by multiple smartphones. All missing RSS values are replaced by a constant. To alleviate the effect of device heterogeneity, the normalization method is introduced to both offline and online stage. Initial radio map is built after the process of normalization. Then, interpolated radio map can be generated by inverse distance weighted method. Subsequently, the initial and interpolated radio map are combined into a new one. Moreover, the principal component analysis is used to reduce dimensions for decreasing computation. Several experiments are conducted to evaluate the performance of the proposed method by comparing with others. Experimental results show that the proposed method has consistent positioning accuracy of manual radio map with saving large amounts of time and storage.

note book

## B5.4. RESPONSE ADAPTIVE MODELLING FOR REDUCING THE STORAGE AND COMPUTATION OF RSS-BASED VLP

Sander Bastiaens, Belgium, sander.bastiaens@ugent.be  
David Plets, Belgium - Luc Martens, Belgium - Wout Joseph, Belgium  
INTEC - WAVES, Ghent University/imec, Belgium

**Key words:** Visible Light Positioning, VLP, RSS, Fingerprint, Storage, Response Adaptive

The precise (location) tracking of automated guided vehicles will be key in enlarging the productivity, efficiency and safety in the connected warehouse or production infrastructure. Combining the modest price tag, the adequate coverage and the potential centimetre accuracy makes Visible Light Positioning (VLP) systems appealing as replacements for the current, high-cost, tracking systems. Model-fingerprinting-based received signal strength (RSS) VLP enables the required accuracy. It requires an elaborate optical channel model design to form sparse channel models, vastly reducing the storage and computation. It is shown that model-fingerprinting-based RSS only requires modelling less than 1 percent of the grid points, in an elementary positioning cell. The sparse model can be re-evaluated as a way to cope with environment changeover. Model recomputation as a way of compensating LED ageing is also studied.

note book

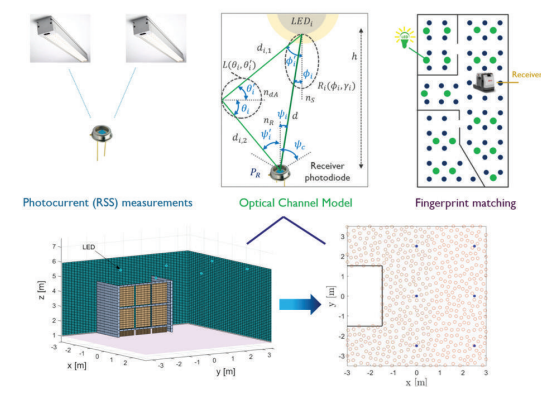



## B6.2. ANDROID APPLICATION FOR INDOOR LOCATION USING SENSOR FUSION: ULTRASOUNDS AND INERTIAL DEVICES

S. Pérez-Bachiller, Spain, sergio.perez@edu.uah.es

D. Gualda, Spain - M. C. Pérez, Spain - J. M. Villadangos, Spain - J. Ureña, Spain - R. Cervigón, Spain

**Key words:** Sensor fusion, Android, Indoor positioning, U-LPS, Ultrasonic signals, Inertial sensors

This paper presents an Android application that allows estimating the position of the device in a robust and flexible way combining ultrasound signals emitted by a set of Ultrasonic Local Positioning Systems (U-LPSs), with inertial information obtained by an Inertial Measurement Unit (IMU) carried by the user and communicated via Bluetooth with the portable device. The U-LPSs are located in areas that require a high accuracy (such as entrances and waypoints) and the trajectory between U-LPSs where there is not ultrasound (US) coverage is estimated by the inertial sensors. When the user is inside an U-LPS area again, the trajectory and cumulative error of the inertial sensor are corrected. Therefore, this proposal provides a flexible and robust application, which is capable of adjusting to the demands of a large environment, reducing the number of U-LPSs to place. Each U-LPS consists of five transducers or beacons whose emissions, at a frequency of 41.67kHz,

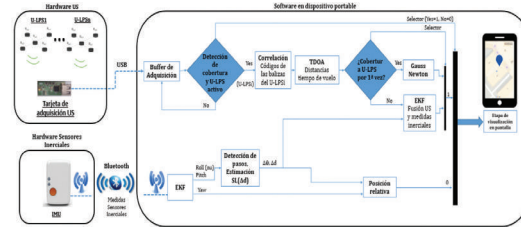

are multiplexed in time and encoded to achieve authentication and reduce interference by multiple access. At reception, an unlimited number of users with their mobile devices could calculate their position autonomously. The ultrasonic signals are captured by an external module that digitizes the signals and sends them to the portable device for processing. At the same time, IMU data is captured and, using an Extended Kalman Filter (EKF), both measures are fused and the possible errors accumulated by the IMU are corrected.

## B6.3. ROBUST LOCALIZATION OF MOBILE ROBOT IN REVERBERANT ROOMS USING ACOUSTIC BEACONS WITH ITERATIVE BAYESIAN FILTERING

Satoki Ogiso, Japan, ogiso@aclab.esys.tsukuba.ac.jp

Koichi Mizutani, Japan, mizutani@iit.tsukuba.ac.jp - Naoto Wakatsuki, Japan - Tadashi Ebihara, Japan

**Key words:** Acoustic beacon, Direction-of-arrival, Particle filter, Multipath

A method of estimating location by acoustical signal and microphone array without the detection of direction-of-arrival is proposed. The proposed method consists of the following steps. First, acoustic beacons in the environment emit signals and the localizing target receives the signals with a microphone array. Next, the localizing target calculates the probability distribution of the location by a particle filter. The cross-correlation functions of the microphone array elements correspond to the location and beacon arrangement. Herein, the cross-correlation functions are used as a likelihood function by projecting them to the localizing state space. The localization result is calculated as the weighted sum of the particles based on their likelihoods. The proposed method is tested and evaluated in an indoor environment with four beacons. The result shows that the proposed method can achieve better localization than the previous method.

note book

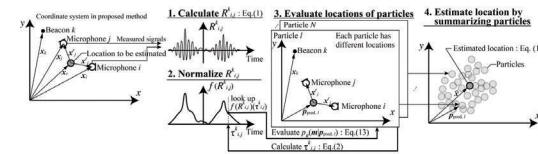

note book

## B6.4. SYNCHRONIZATION-FREE AND LOW POWER TDOA FOR RADIO BASED INDOOR POSITIONING

Maximilian von Tschirschnitz, Germany, maximilian.tschirschnitz@intel.com  
 Marcel Wagner, Germany

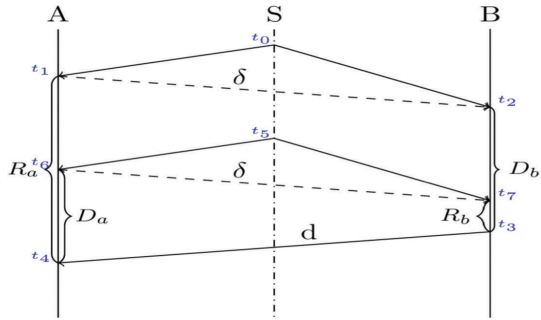

**Key words:** ToF, TDOA, Indoor Positioning, Scalable Infrastructure, Low Power Positioning

In this paper, we propose a method to calculate time difference of arrival values between a signal source and several transceivers without the need to synchronize any clocks. The method is allowing the signal source to operate on very low power because it does not need to receive but only has to send short pulses. We derive this new method from an existing protocol, called Whistle, and show how our improvements reduce its error to make the method suitable for radio-based applications. We present a theoretical analysis as well as simulations and first results of an implementation.

note book

## B6.5. MOVING OBJECT TRACKING BASED ON HIGH PRECISION OPTO-ACOUSTIC BPSK-CDMA DISTANCE MEASUREMENT

Dominik Esslinger, Germany, esslinger@isys.uni-stuttgart.de  
 Philipp Rapp, Germany - Oliver Sawodny, Germany - Cristina Tarin, Germany  
 Institute for System Dynamics, University of Stuttgart, 70550 Stuttgart, Germany

**Key words:** Distance measurement, Time-of-flight, Ultrasound, BPSK, CDMA, Doppler effect

Opto-acoustic indoor localization systems based on ultrasound and infrared allow the tracking of tools and hand movements in complex manual industrial assembly and handling processes, e. g. the application of glue or adhesive sealing material. However, this requires a localization system that is able to track the position of multiple objects simultaneously during movement when the system is affected by Doppler effects and noise. The amplitude shift keying (ASK) modulation method within the code division multiple access (CDMA) environment using Gold codes is focused in previous publications for unilateral distance measurement of non-moving objects. The novelty of this contribution is the implementation of the binary phase shift keying (BPSK) modulation method and the consideration of moving objects with a Doppler effect mitigation algorithm. This algorithm can be performed in real time with an acquisition and a tracking step. Moreover, BPSK provides a permanently available phase information that

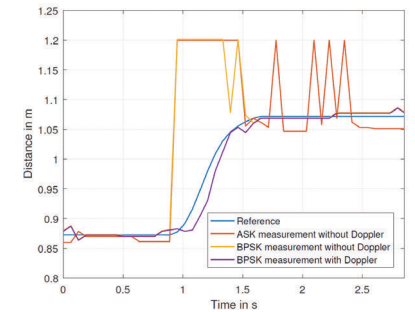

can be used for exact positioning of multiple moving transmitters and ensures more robustness to modeling errors and noise. In this publication unilateral distance measurement results for up to four moving objects simultaneously with various speeds up to 0.54 m/s are presented showing the superiority of BPSK-CDMA with Doppler effect mitigation (mean errors below 6.9 mm) compared to ASK-CDMA and BPSK-CDMA without Doppler effect consideration.

note book

## B7.1. UWB RANGING FOR RAPID MOVEMENTS

Tanguy Risset, France, tanguy.risset@insa-lyon.fr  
 Claire Goursaud, France - Xavier Brun, France  
 Kevin Marquet, France - Fabrice Meyer, France

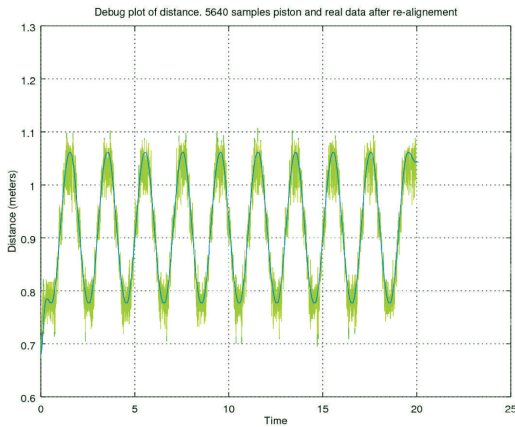

**Key words:** *UWB, Localisation, Ranging*

Ultra Wide Band (UWB) provides ranging capabilities much more precise than other radio communication technologies. This paper presents experimental measurement of ranging precision between two UWB tags when one of the tag is moving fast. The use of a specific electro-pneumatic actuator provides precise ground truth for real distance. This study will allow to improve ranging for human wearable tags as for example sportsmen positioning or interaction between dancers during live performances. We show in particular how the inherent noisy measurement has to be smoothed to obtain more accurate ranging.

note  
book

## B7.2. ASSESSING A UWB RTLS AS A MEANS FOR RAPID WLAN RADIO MAP GENERATION

Sharareh Naghdi, Canada, sharareh.naghdi@ucalgary.ca  
 Chandra Tjhai, Canada, chandra.tjhai@ucalgary.ca - Kyle O'Keefe, Canada, kpgokeef@ucalgary.ca  
 Position, Location, And Navigation (PLAN) Group, Department of Geomatics Engineering,  
 Schulich School of Engineering, University of Calgary, Alberta, Canada

**Key words:** *UWB; RTLS, Radio maps, WLAN, Bluetooth*

The utility of a commercially available low cost ultra-wideband (UWB) real-time location system (RTLS) to provide reference position information for the generation of accuracy high-density radio maps is investigated. The UWB RTLS hardware is deployed in a medium-sized office space in a university building and UWB ranges are recorded in static and kinematic mode over an array of precisely surveyed locations within the room. WLAN received signal strength indicator (RSSI) observations are taken simultaneously to UWB range measurements. Radio maps are then generated by interpolating the observed RSSI measurements using both the precisely surveyed coordinates and the UWB RTLS coordinates. The maps are compared and the feasibility of the method is discussed.

note  
book

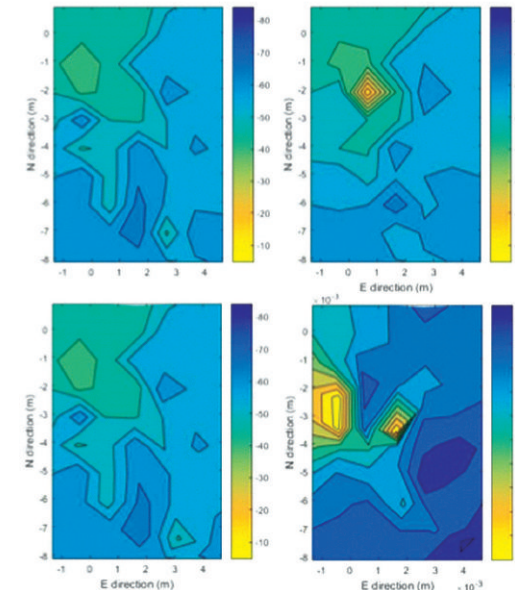



## B7.3. IMPLEMENTATION CHALLENGES OF SYNCHRONISATION OF UWB NODES IN TDOA STRUCTURES

Reza Zandian, Germany, zandian.reza@fh-swf.de - Ulf Witkowski, Germany, witkowski@fh-swf.de

**Key words:** Localization, TDOA, Synchronization, UWB, Wireless, Clock Source

This paper discusses the synchronization issues of the unilateral TDoA method applied in ultra-wideband (UWB) localization systems. Focus of the paper is on implementation aspects of the synchronization. At first, the structure of unilateral TDoA method is explained and a method for synchronization is proposed. In the next step, typical implementation challenges of synchronization such as rounding effect, outliers, filtering, packet loss detection and thermal dependencies are discussed and for each problem a solution is provided. A set of experiments have been performed on different clock sources to study their effect on the accuracy of synchronization. The results of the experiments confirm that the voltage and temperature compensated oscillator has the highest accuracy, lowest frequency jitter but longest steady state time among

the other variants applied. At the end, the performance of the synchronization solution in real experiments are demonstrated. The results prove that the proposed methods can successfully reduce the negative effects of clock inaccuracies. According to the results, localization accuracy of 3cm in average is achieved when a proper oscillator is used.

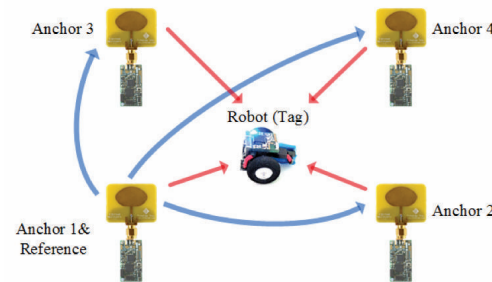

note book

## B7.4. A REAL-TIME UWB MULTI-CHANNEL INDOOR POSITIONING SYSTEM FOR INDUSTRIAL SCENARIOS

Guido Schroerer, Germany, guido.schroerer@siemens.com

**Key words:** UWB, TDoA, Wireless Synchronization, Indoor Positioning

Tracking products, machines and important objects in factories is a key task for future efficient manufacturing processes. Providing workers and robots with accurate and reliable location information is the foundation for this innovation. In industrial facilities, the environment is more complex compared to consumer indoor positioning scenarios. Heavy machinery often blocks the line of sight path. Metal walls and surfaces increase reflections and multi-path effects. An ultra-wideband based time-difference-of-arrival positioning system is investigated. Multichannel base stations are used to increase the system robustness. Multi-path and non-line of sight situations are evaluated with respect to the channel effects and the influence on the position accuracy.

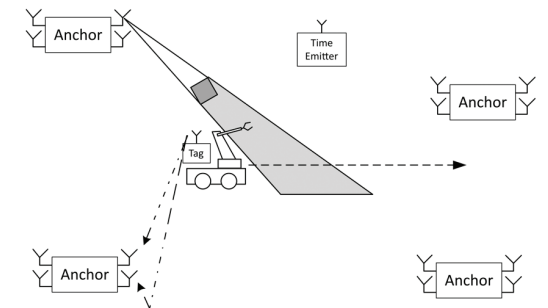

note book

# C1.1. RECURSIVE BAYESIAN FILTERS FOR RSS-BASED DEVICE-FREE LOCALIZATION AND TRACKING

Ossi Kaltiokallio, Finland, ossi.kaltiokallio@aalto.fi  
Roland Hostettler, Finland - Neal Patwari, USA - Riku Jäntti, Finland

*Key words: Received signal strength, Wireless sensor networks, Bayesian filtering, Positioning and tracking*

Received signal strength (RSS)-based device-free localization applications utilize the communication between wireless devices for locating people within the monitored area. The technology is based on the fact that humans cause changes in properties of the wireless channel which is observed in the RSS, enabling localization of people without requiring them to carry any sensor, tag or device. Typically this inverse problem is solved using an empirical model that relates the RSS to location of the sensors and person, and utilizing either an imaging method or a particle filter (PF) for positioning. In this paper, we present an extended Kalman filtering (EKF) solution that incorporates some of the beneficial properties of the PF but has a lower computational overhead. In order to make the EKF work, we also need to reconsider how the measurements are sampled and processed, and a new processing scheme is proposed. The developments are validated using simulations and experimental data, and the results imply: i) the non-linear filters outperform a popular imaging method; ii) the robustness of the EKF and PF is improved using the proposed processing scheme; and iii) the EKF achieves similar performance as the PF as long as the new processing scheme is used.

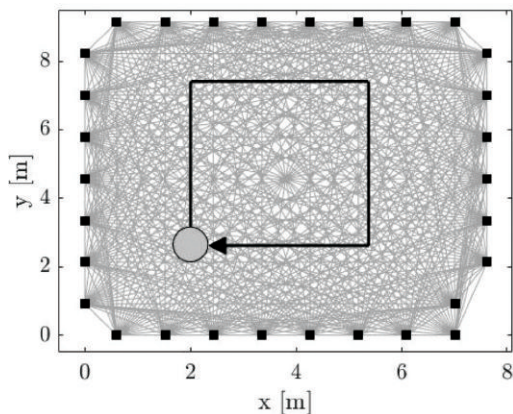

note book

# C1.2. SPECIFIC STUDY OF DELTA RANGE POSITIONING INDOOR POSITIONING ALGORITHM WITH DIFFERENCE OF DISTANCE MEASUREMENTS

Alexandre Vervisch Picois, France, alexandre.vervisch-picois@telecom-sudparis.eu - Nel Samama, France

*Key words: Least-Square algorithm, Carrier phase measurements, Pseudolite*

There are several ways to carry out positioning in difficult environment like indoors. Most of those methods use physical measurements from a beacon (radio, sound or light). One way consists of acquiring a propagation time of a signal or a variation of a propagation time to get a distance or a distance variation between the beacon and the antenna that we want to position. We can use radar, radio beacons (like pseudolites or any kind of equivalent networks), Ultra Wide Band or ultrasound beacons. The ultimate issue consists of obtaining the better positioning in terms of accuracy with physical measurements that are equivalent to distance measurements. The purpose of this article is to study an algorithm that allows carrying out absolute indoor positioning with distance variation measurements. In a previous paper, we had presented an

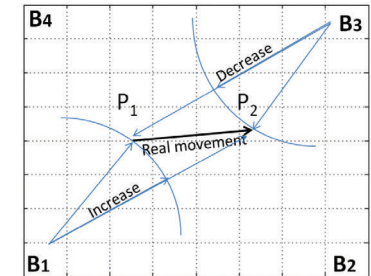

algorithm that is adapted from the least-square algorithm used by the GNSS receivers. In the present paper we are discussing about the limitations of the algorithm and we propose a method to study these limitations in detail. Finally we carry out the algorithm to study its performance from real measurements.

note book

# C1.3. INFORMATION THEORETIC FRAMEWORK FOR THE OPTIMIZATION OF UWB LOCALIZATION SYSTEMS

Anthony Schenck, Belgium, Anthony.schenck@uantwerpen.be - Edwin Walsh, Belgium - Jonas Reijnders, Belgium  
 Ted Ooijsaar, Belgium - Risang Yudanto, Belgium - Erik Hostens, Belgium - Walter Daems, Belgium - Jan Steckel, Belgium

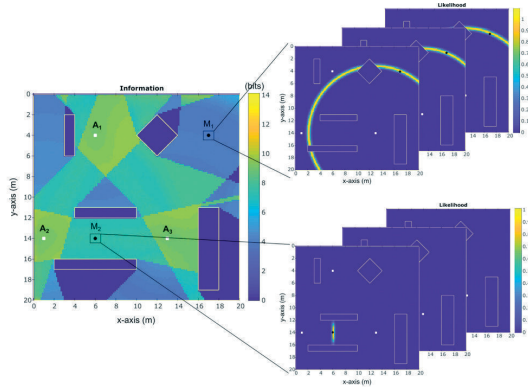

*Key words: Information Theory, UWB-ranging, Indoor positioning systems*

In this paper we will propose a method to evaluate the performance of a certain ultra-wide band fixed anchor configuration in complex indoor environments by making use of the mutual information as the performance metric. Furthermore we will introduce an incremental algorithm that will determine an optimized anchor configuration for complex indoor environments. By making use of heuristics we are able to ensure that the time required to complete the algorithm is feasible on commercial grade computers, even for large-scale floor plans.

note book

# C1.4. LOCURA: A NEW LOCALISATION AND UWB-BASED RANGING TESTBED FOR THE INTERNET OF THINGS

Adrien van den Bossche, France, adrien.van-den-bossche@irit.fr  
 Rejane Dalcé, France - Nicolas Gonzalez, France - Thierry Val, France



*Key words: Ranging protocols, Time Of Flight, Testbed, Indoor Localisation*

As many applications of the Internet of Things assume the knowledge of mobile object position, localisation has become a hot topic in the academic research community as well as for industrial R&D departments. Although distance measurements (ranging) and localisation can be studied through simulations, using real nodes provides more accurate and realistic results, especially when the nodes are deployed in the target environment. In order to support this effort, the paper presents LocURa4IoT, a new Localisation and UWB-based Ranging testbed for the Internet of Things. The testbed is made of 20 nodes based on Decawave DW1000 UWB-based transceiver and Arduino-compliant micro-controllers. The nodes' control infrastructure is presented in the paper, as well as a few results obtained with LocURa. Two open datasets are also published with the paper.

note book

## C2.1. LSTM-BASED ZERO-VELOCITY DETECTION FOR ROBUST INERTIAL NAVIGATION

Brandon Wagstaff, Canada, brandon.wagstaff@robotics.utias.utoronto.ca - Jonathan Kelly, Canada

note  
book

*Key words: Zero-velocity aided INS, IMU, Foot-mounted, Zero-velocity detection, Machine learning*

We present a method to improve the accuracy of a zero-velocity-aided inertial navigation system (INS) by replacing the standard zero-velocity detector with a long short-term memory (LSTM) neural network. While existing threshold-based zero-velocity detectors are not robust to varying motion types, our learned model accurately detects stationary periods of the inertial measurement unit (IMU) despite changes in the motion of the user. Upon detection, zero-velocity pseudo-measurements are fused with a dead reckoning motion model in an extended Kalman filter (EKF). We demonstrate that our LSTM-based zero-velocity detector, used within a zero-velocity-aided INS, improves zero-velocity detection during human localization tasks. Consequently, localization accuracy is also improved. Our system is evaluated on more than 7.5 km of indoor pedestrian locomotion data, acquired from five different subjects. We show that 3D positioning error is reduced by over 34% compared to existing fixed-threshold zero-velocity detectors for walking, running, and stair climbing motions. Additionally, we demonstrate how our learned zero-velocity detector operates effectively during crawling and ladder climbing. Our system is calibration-free (no careful threshold-tuning is required) and operates consistently with differing users, IMU placements, and shoe types, while being compatible with any generic zero-velocity-aided INS.

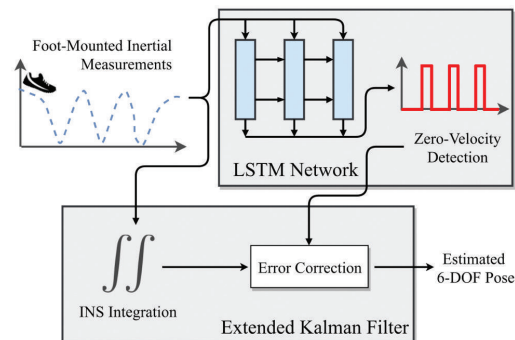

## C2.2. ELEVATOR AND ESCALATOR CLASSIFICATION FOR PRECISE INDOOR LOCALIZATION

N. Kronenwett, Germany, Nikolai.Kronenwett@kit.edu - S. Qian, China - K. Mueller, Germany - G. F. Trommer, Germany

*Key words: Foot-mounted sensors, Elevator detection, Escalator detection, Indoor navigation*

This paper presents a new finite state machine based elevator and escalator classification for pedestrians with foot mounted MEMS sensors. Generally, stance phase detectors are used to reduce the position error drift by applying Zero-Velocity-Updates (ZUPTs) in the navigation filter. However, if the person rides an elevator or escalator ZUPTs should not be processed during the stance phases of the foot. A novel elevator and escalator classifier separating the motion of the moving platform in different sub-states is introduced. Unique is the consideration of foot movement, so that the person can walk during the ride with an elevator or escalator. In addition, powerful motion constraints differing for the various platforms are presented which enable accurate positioning performance. Horizontal ZUPTs and delta ZUPTs are introduced for elevator rides and absolute velocity measurements based on an escalator

velocity model are used to limit the position error growth during escalator movement. We evaluated the presented algorithms with recorded sensor data and achieved an average return position error of 0.72% in the vertical axis and an average error of 0.58% in the horizontal plane of the total walked distance of 1162.09m.

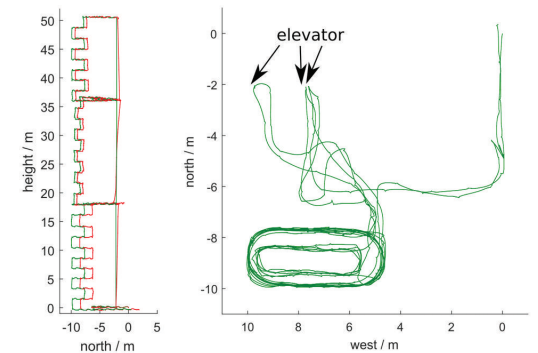

note  
book

# C2.3. CORRECTIVE TRACK FORM MATCHING FOR REAL-TIME PEDESTRIAN NAVIGATION

Pekka Peltola, England, pekka.peltola@csic.es  
 Fernando Seco, Spain - Antonio R. Jimenez, Spain  
 Terry Moore, England - Aled Catherall, England

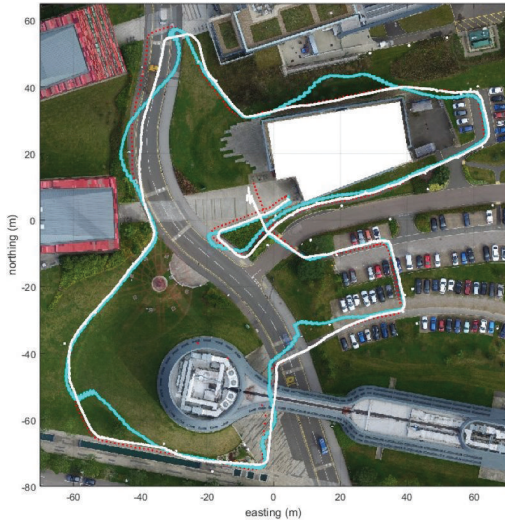

*Key words: Track form matching, Pedestrian dead reckoning, GNSS, Fusion, Navigation, Track-to-track*

The Global Navigation Satellite Systems (GNSS) receivers often have difficulties within the urban setting. Furthermore, indoors the ordinary receivers do not function. For a short term gaps in positioning fixing measurements, a foot-mounted pedestrian dead reckoning system can offer a replacement solution. This paper presents a novel corrective solution for the gaps and the low-quality GNSS measurements fusion with the pedestrian dead reckoning (PDR). The corrective track form matcher consists of two parts. A short track form matcher compares the PDR track against the GNSS track and infers anomalies in the GNSS track. The short track form matcher tags the GNSS measurements as reliable or unreliable. The long track form matcher uses the reliable GNSS measurements and transforms the PDR track by weighting these good quality measurements more. The accuracy (average error limit of 96%) in the test case improves from 7.56m to 4.39, this is by 1.72 times.

note book

---

.....

.....

.....

.....

.....

.....

.....

.....

.....

.....

.....

.....

.....

.....

.....

.....

.....

.....

.....

.....

.....

.....

.....

.....

.....

.....

.....

.....

.....

.....

# C2.4. AN INDOOR POSITIONING AND NAVIGATION APPLICATION FOR VISUALLY IMPAIRED PEOPLE USING PUBLIC TRANSPORT

Thomas Moder, Austria, thomas.moder@tugraz.at - Clemens Reitbauer, Austria  
 Karin Wisiol, Austria - Roman Wilfinger, Austria Manfred Wieser, Austria

*Key words: Pedestrian navigation, Blindness, Dead Reckoning*

More than 3% of the world's population are visually impaired. An approach was taken to create an infrastructure independent, smartphone-based navigation application, which can be used by visually impaired people to navigate in public transport systems. The presented method combines a timetable request and route planning in the public transport system with indoor positioning and navigation between different public transport vehicles. The approach is based on a graph-based pedestrian dead reckoning, which uses the existing tactile paths for positioning as well as guidance. The result of tests and a demonstration performed at a main railway station showed, that the smartphone application could deliver mean position residuals within a range of 5 to 6m. Within this range, the guidance instructions provided were clear and useful, allowing for visually impaired people to navigate between different vehicles and platforms. The total walked distance of 1162.09m.

note book

---

.....

.....

.....

.....

.....

.....

.....

.....

.....

.....

.....

.....

.....

.....

.....

.....

.....

.....

.....

.....

.....

.....

.....

.....

.....

.....

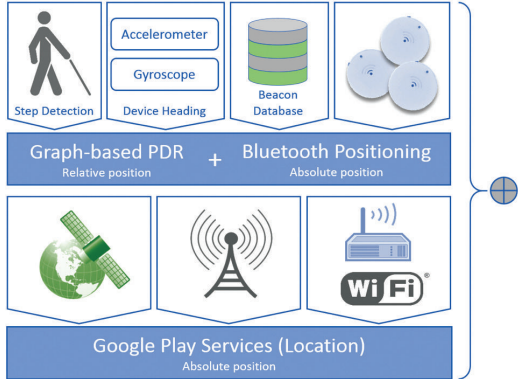

## C2.5. PEDESTRIAN DEAD RECKONING WITH TURN-BASED CORRECTION

Yonghao Zhao, Singapore, e0009108@u.nus.edu  
 Wai-Choong Wong, Singapore, wong\_lawrence@nus.edu.sg  
 Hari Krishna Garg, Singapore, eleghk@nus.edu.sg  
 Tianyi Feng, Singapore, e0204994@u.nus.edu

**Key words:** *Pedestrian Dead Reckoning, Map Matching, Motion Detection*

Pedestrian dead reckoning (PDR) is a popular localization approach. However, PDR is error prone at turning points. During a turn, a small error in heading estimation can cause severe accumulated positioning errors thereafter. In this paper, we propose a turn-based correction approach which aims to reduce the potential accumulated errors caused by inaccurate heading estimations during turns. We consider a crowdsourcing environment in which previous users' data can help in the positioning of present users. For previous and present users moving in reverse directions and turn at the same position, we match the previous user's turning position with the present user's using Kullback-Leibler (KL) divergence based on the

received signal strength (RSS) scans collected. Upon a match, the previous user's pre-turn positions can be used to improve the post-turn positions of the present user. Tests are done for different types of paths and the results show that the proposed approach can effectively reduce the PDR errors caused by inaccurate heading estimations at turning points.

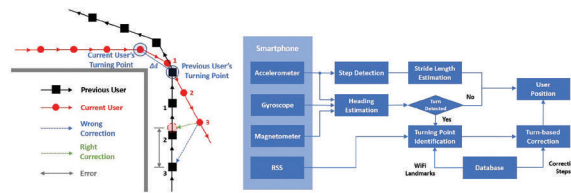

note book

## C2.6. BUILDING INDIVIDUAL INERTIAL SIGNALS MODELS TO ESTIMATE PDR WALKING DIRECTION WITH SMARTPHONE SENSORS

Johan Perul, France, johan.perul@ifsttar.fr - Valérie Renaudin, France

note book

**Key words:** *PDR, Walking direction, WAISS, Expectation maximisation, Inertial sensors, Magnetometers, Acceleration models*

Inertial and magnetic sensors based PDR approaches are particularly interesting for pedestrian location since they don't require any specific infrastructure. Estimating the walking direction, which is essential for PDR strategy, remains difficult with handheld sensors. WAISS is a new method that integrates hand movement and is independent of the misalignment between the walking direction and the pointing direction that estimates the walking direction. It uses statistical models of the hand accelerations in the horizontal plane. The paper studies how to create the best possible models. Among the features under study are the number of strides used to learn the models, different acquisition contexts and walking directions. Finally, the complexity of models needed for a given person is discussed. 100 strides over curved and straight line walks combined with a bi-modal Gaussian Mixture Model gives the best walking direction estimate with a 15° mean error over a 325 m indoor/outdoor walk performed by four subjects.

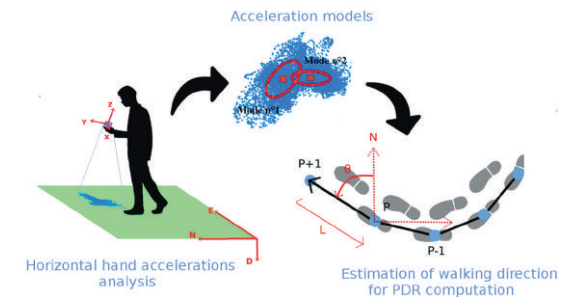

# C3.1. A SIMULATION-BASED APPROACH TO GENERATE WALKING GAIT ACCELERATIONS FOR PEDESTRIAN NAVIGATION SOLUTIONS

Mahdi Abid, France, mahdi.abid@ifsttar.fr - Valérie Renaudin, France  
 Thomas Robert, France - Yannick Aoustin, France - Éric Le Carpentier, France

note  
book

**Key words:** *Handheld devices, Human walking gait, Multibody system, Inertial data, Step-level asymmetry*

In indoor environments, pedestrian dead reckoning (PDR) is the most used strategy for pedestrian position estimation from inertial data collected with handheld devices. PDR process recursively estimates positions using step length estimation based on parametric models that take into consideration some physiological parameters, displacement features and acceleration statistical properties. The coefficients of these models need frequent adjustment to limit cumulative errors induced by alteration of gait pattern. A large experimental database providing information about human locomotion variability is required for this calibration. However, the development of such database is costly in terms of time and effort. To make the collected data as reliable as possible, several gait-affecting factors should be considered, which highly increases the number of measurement trials. In this paper, we propose an alternative way of generating locomotion data that consists in simulating human walking gait motion under different conditions.

We propose a multibody system simulator taking into account possible step-level asymmetry induced by handling a device in hand, as well as the correlation between arms and legs motions during gait. Our simulation approach was evaluated with data from overground walking experiments on one test subject. Preliminary results show some similarities between acceleration profiles related to different body parts, and the same variation trends of selected acceleration items in function of carrying mode and gait velocity.

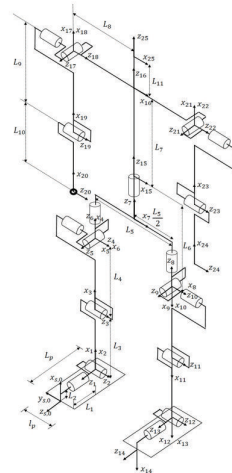

The 19-link biped model with dimensions and local frames in accordance with Denavit-Hartenberg convention

# C3.2. CLASSIFYING ELEVATORS AND ESCALATORS IN 3D PEDESTRIAN INDOOR NAVIGATION USING FOOT-MOUNTED SENSORS

Susanna Kaiser, Germany, susanna.kaiser@dlr.de - Christopher Lang, Germany

note  
book

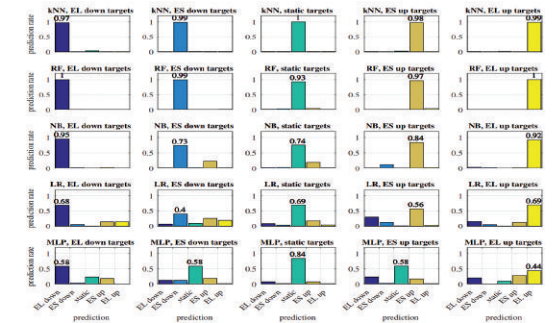

**Key words:** *Pedestrian navigation, Indoor navigation, Human activity recognition, Escalator detection, Elevator detection, Context classification*

For quick and targeted rescuing of individuals in emergency situations indoors an accurate knowledge of the current floor-level by the injured and rescue personnel is essential. In this paper, we investigate detection and characterization of transportation platforms like elevators and escalators using foot-mounted inertial measurement units including magnetometer and barometer data for applications in 3D pedestrian navigation. Several data sets including elevator and escalator rides in various environments and allowing for superposed activities by the pedestrian are recorded for this purpose. A variety of features and the selection of feature subsets are analyzed for classifying among static environments, elevator environments (up/down), and escalator environments (up, down). The features are compared via an information gain metric and selected classifier concepts are analyzed with focus on fast response times necessary for dead-reckoning navigation. We identified features exploiting statistical characteristics of the magnetic intensity and the acceleration to be most promising taking into account fast response times. The resulting feature space is highly non-linear and is best approximated locally.

### C3.3. A NOVEL STEP DETECTION AND STEP LENGTH ESTIMATION ALGORITHM FOR HAND-HELD SMARTPHONES

Nicolò Strozzi, Italy, nicolo.strozzi@studenti.unipr.it - Federico Parisi, Italy - Gianluigi Ferrari, Italy

**Key words:** *Inertial navigation, Smartphone, Dead reckoning, Step detection*

In this paper, we present an innovative inertial navigation system based on the data collected through the Inertial Measurement Unit (IMU) embedded in a commercial smartphone. We propose an innovative step detection algorithm which is independent of the holding mode, the only assumption being that the device is hand-held (i.e., the user is texting/navigating or phoning) and its movement is related to the upper body displacement during walking. We also present a new approach able to automatically calibrate the step length estimation formula according to the smartphone positioning. The developed algorithms have been validated through a test campaign in which we have evaluated the system performance considering three different smartphone models and different path lengths. The obtained results

show that the maximum step detection error is always below 4% (average: 2.08%; standard deviation: 1.82%) whereas the maximum path length estimation error is below 8.1% (average: 3.6%; standard deviation: 1.81%) in all the considered cases.

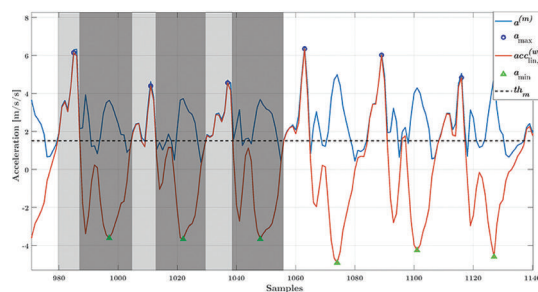

note  
book

.....

.....

.....

.....

.....

.....

.....

.....

.....

.....

.....

### C3.4. STEP LENGTH ESTIMATION USING UWB TECHNOLOGY: A PRELIMINARY EVALUATION

Luis Enrique Díez, Spain, luis.enrique.diez@deusto.es - Alfonso Bahillo, Spain - Timothy Otim, Spain - Jon Otegui, Spain

**Key words:** *UWB, Step Length Estimation*

The information about the pedestrian's step length is useful for a great variety of applications. The technologies that are commonly selected for estimating the step length offer very high accuracies, such as millimeter-level accuracy in the case of optical systems or centimeter-level with ultrasound technology. However, their use is usually restricted to dedicated small indoor laboratories, which makes it difficult to collect realistic data belonging to day-to-day activities. For this reason, despite their high precision, these systems are not usually used in the field of inertial pedestrian navigation. UWB technology offers only decimeter-level ranging accuracy but provides larger coverage areas. Therefore, it could be considered as a candidate technology for step length estimation purposes in more larger testing scenarios, which can be useful for the training of pedestrian navigation systems. A method based on the inter-feet ranges obtained an average step length error of 9.9 cm

(±7.1 cm) and a median relative error of 15%, while one of method based on the feet positions got an average error of 11.9 cm (±16.3 cm), but only a median error of 5.9 cm if Line-Of-Sight (LOS) scenarios are only considered. These preliminary results confirm that errors of a few centimeters can be achieved. Now, further research is needed in order to evaluate if the combination of the accuracy and coverage provided by UWB is really useful for training pedestrian navigation systems.

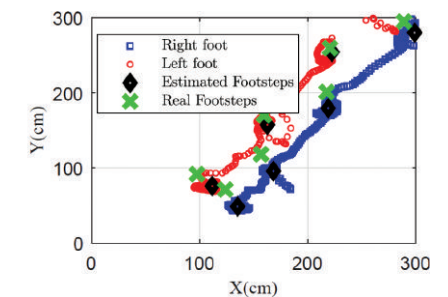

note  
book

.....

.....

.....

.....

.....

.....

.....

.....

.....

.....



# C4.1. INDOOR POSITIONING USING OFDM-BASED VISIBLE LIGHT COMMUNICATION SYSTEM

Birendra Ghimire, Germany, birendra.ghimire@iis.fraunhofer.de - Jochen Seitz, Germany - Christopher Mutschler, Germany

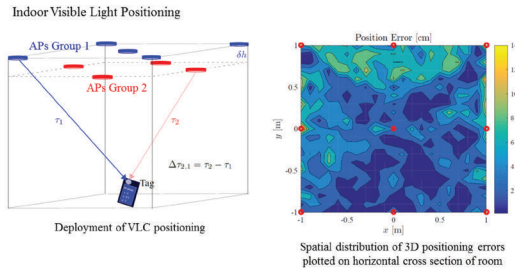

**Key words:** Visible light positioning, IoT, OFDM, TDoA, Multilateration, Phase Estimation

Precise indoor positioning is essential to support emerging applications of location aware mobile computing. A popular use case is tracking tools and persons within a factory for quality control of processes. Likewise, storing and retrieving goods in a warehouse, moving mobility impaired people in hospitals, at stations, and airports are representatives of numerous other applications demanding

precise position estimation in an indoor environment. Current positioning techniques that use signals transmitted in the Gigahertz region of radio-frequency spectrum do not provide highly accurate position estimates due to multipath propagation of signals. We propose a novel positioning system which uses the entities of visible light communication (VLC) system as anchors and tags. Our technique scales with the number of tags and the VLC network provides both positioning and communication capabilities. We estimate the time differences of arrival between anchor points and tags using positioning reference signals embedded into the air-interface of the VLC system using orthogonal frequency division multiplexing (OFDM) and transmit the signals synchronously from the anchor points. Simulation results show that positioning accuracy of 10 cm or better is possible for over 95% of users if the sampling clock offset is better than 10 ppm, clock jitter is below 1 ps, and a bit resolution of at least 16 bits is available.

note book

# C4.2. INDOOR POSITIONING USING REFLECTED LIGHT AND A VIDEO CAMERA

Shota Shimada, Japan, shimadas@eis.hokudai.ac.jp  
 Hiromichi Hashizume, Japan, has@nii.ac.jp  
 Masanori Sugimoto, Japan, sugi@ist.hokudai.ac.jp

**Key words:** Visible light communication, Visible light positioning, Indoor localization, Received signal strength indication

This paper describes an indoor positioning technique using a video camera that captures LED light reflected by the floor. Indoor positioning for mobile devices can be very useful. In particular, localization techniques using LEDs and cameras, so-called visible light positioning, are known to be effective and have high accuracy. However, existing methods have the constraint that they must capture the light source directly. This requires a high-performance processor and a high-resolution image. However, light sources cannot always be detected directly (loss of signal: LOS). Our proposal aims to solve these problems by estimating the position of a camera that does not face the light directly but monitors light reflected by the floor. Specifically, individual LED ceiling lights emit sinusoidal waves modulated with different frequencies, and the camera captures the overlapped light from the LEDs reflected by the floor then demodulates the signal. The camera need not seek the ceiling lights directly from an image, unlike existing methods. The position can be estimated using any part of the image because usually the ceiling light is reflected by the whole floor. Experimental results show that the proposal requires less than 1/100 as many pixels for localization as existing methods and the position can be estimated within 0.4m at the 90<sup>th</sup> percentile in a 2.5m square room. We show that the cause of errors is mainly the difference between the LED diffusion model and the actual light diffusion, the occlusion and the noise and movement of the camera. Overcoming these problems remains as our future work.

note book

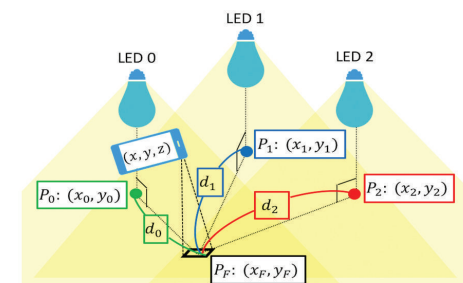

## C4.3. SIMPLIFIED CALIBRATION PROCESS FOR A PSD-BASED OPTICAL IPS

José Luis Lázaro-Galilea, Spain, josel.lazaro@uah.es - David Rodríguez-Navarro, Spain - Felipe Espinosa, Spain  
 Álvaro De-La-Llana-Calvo, Spain - Carlos Santos, Spain

**Key words:** Indoor Positioning Systems, Optical Signal, Transformation, Infrared, PSD sensor

Indoor Positioning Systems (IPS) usually require a calibration process to obtain precise measurements. In the case of systems with optical components, calibration may be time-consuming and requires a specific infrastructure. In this paper, we present a model and a calibration method for an optical sensor based on Direct Linear Transformation (DLT), which directly obtains the transformation between the sensor surface and the surface of the moving agent. Our method provides results similar to those that would be obtained with an optimal calibration, with differences of only a few mm.

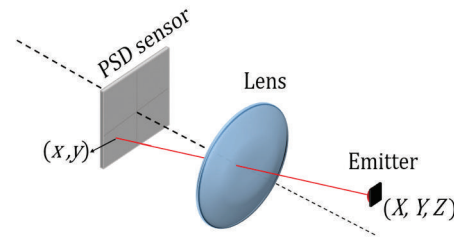

note  
book

## C4.4. QADA-PLUS: A NOVEL TWO-STAGE RECEIVER FOR VISIBLE LIGHT POSITIONING

Stefanie Cincotta, Australia, stefanie.cincotta@monash.edu - Cuiwei He, Australia  
 Adrian Neild, Australia - Jean Armstrong, Australia

**Key words:** Visible light positioning, Quadrant photodiode, Aperture, QADA, QADA-plus

In this paper, we introduce a new two-stage receiver structure for visible light positioning (VLP) and a particular implementation of the new structure called the QADA-plus receiver. By using two sensors, one a photodiode (PD) based sensor and the other an image-based sensor, the new structure exploits the strengths of both technologies while avoiding their weaknesses. The QADA-plus uses a quadrant angular diversity aperture receiver (QADA) for the PD-based stage. The QADA has a very compact, planar structure suitable for incorporation in a smartphone or other small device and has been shown to provide good angular diversity in a proof-of-concept laboratory experiment. The QADA is also, unlike typical image sensors, able to reliably demodulate high frequency visible light signals. In this paper extensive simulation results for a range of typical indoor scenarios and realistic parameters show that the QADA has the potential to

accurately estimate the polar and incident angle of light transmitted by LED luminaires. The average absolute error in estimation of incident angle was  $0.0006^\circ$  and for polar angle estimation was  $0.005^\circ$ . A limitation of these simulations is that it is assumed that the luminaires can be modelled as point sources and that the dimensions of the QADA are very precisely known. Incorporation of the QADA in the new two-stage QADA-plus receiver removes these limitations in two ways – the image-based receiver provides very accurate angle-of-arrival estimates and the use of visible reference points means that the QADA-plus is compatible with luminaires of any shape.

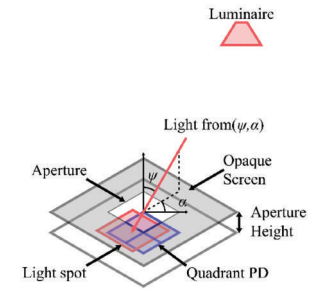

note  
book

# C4.5. UNMODULATED VISIBLE LIGHT POSITIONING USING THE ITERATED EXTENDED KALMAN FILTER

Robin Amsters, Belgium, robin.amsters@kuleuven.be - Eric Demeester, Belgium - Nobby Stevens, Belgium - Peter Slaets, Belgium

**Key words:** Kalman filter, Visible Light Positioning, Mobile robot

With the rise of solid state lighting, wireless positioning based on visible light is becoming more appealing. However, current visible light positioning systems require additional hardware at the transmitter end in order to modulate the light intensity. A receiver demultiplexes the combined signal from multiple sources into its components, which are then used by the positioning algorithm. This paper investigates the possibility of using unmodulated visible light for mobile robot positioning. Less hardware is required, consequently cost and complexity are much lower. Position estimation is achieved by modeling the received signal strength inside a room, which is used as input for an Iterated Extended Kalman filter. We show that the proposed approach can achieve decimeter level accuracy in a simulation environment. Even with imperfect calibration, the total positioning error usually remains below 0.5 m. Positioning errors due to blocking of the receiver can be mitigated by employing an innovation magnitude bounds test. We also show that by employing multiple receivers, accuracy and robustness can be further improved.

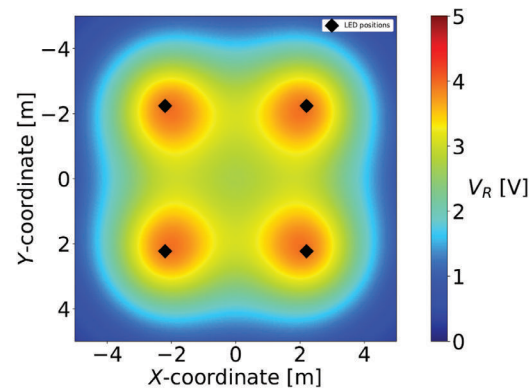

note book

# C5.1. GEOMETRIC CONSTRAINT MODEL AND MOBILITY GRAPHS FOR BUILDING UTILIZATION INTELLIGENCE

Thomas Burgess, Austria, thomas.t.burgess@gmail.com  
Barbara Metzler, Austria - Andreas Ettliger, Austria - Hans-Berndt Neuner, Austria

**Key words:** Indoor navigation, Internet of Things, Data Mining, Particle Filter, Data Acquisition

In recent years the availability of mobile indoor way finding technologies, Internet-of-Things sensor infrastructures, and geographic information systems has dramatically increased. These systems have been introduced for many reasons, such as: increasing accessibility to users with reduced mobility, optimizing logistics, or reducing the environmental impact of facilities. While these technologies can bring some new insight in how buildings are used, they all suffer from limitations in coverage, accuracy, or scalability. However, when they are combined, a new window into the understanding of human mobility and building utilization is opened.

This paper introduces methods to increase accuracy of data obtained from an off-the-shelf commercial indoor navigation by including Internet-of-sensor infrastructure and geographic information through a Geometric Constraint Model. Furthermore, a Mobility Graph is introduced to visualize trajectory distributions. A simple experiment was conducted to validate the methods. For this, a long narrow hall was equipped with iBeacon infrastructure, an \indoor Navigation instance, and a few cheap Raspberry Pi based sensor stations. The environment was mapped using state-of-art geodetic measurements, and a set of recorded experiments were made. In such a long and narrow environment the indoor navigation system is unable to resolve features along the short traverse axis. Without a combined analysis, a divider in the environment is not discernible in the Mobility Graph, while results using the Geometric Constraint Model introduced in this paper clearly indicate the presence of this divider. Automating this approach, can bring indoor location analytics from a descriptive to a prescriptive regime. Furthermore, the application of Mobility Graph provide a useful tool to better understand large indoor navigation data sets.

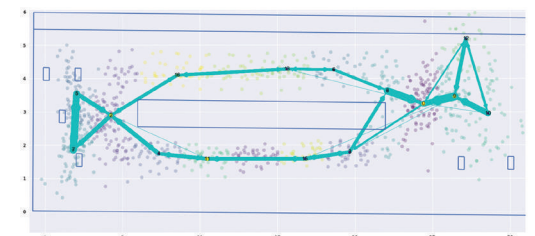

note book

## C5.2. VLF MAGNETIC POSITIONING IN MULTISTORY PARKING GARAGES

Maxim Ralchenko, Canada, maxim.ralchenko@vitalalert.com  
Mike Roper, Canada

note  
book

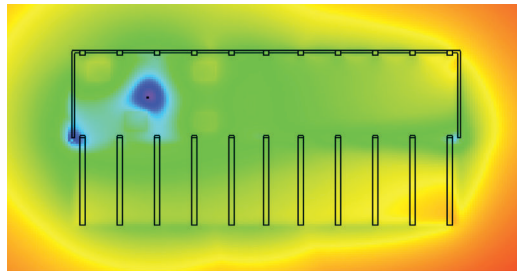

*Key words: Indoor Spatial Data Model & Indoor Mobile Mapping*

A significant problem with typical satellite-based methods (e.g. GPS) to position an autonomous vehicle (AV) is that they are rendered ineffective when satellite signals are blocked, such as in tunnels and parking garages. Low-frequency magnetic positioning systems have been proposed, but such approaches are adversely affected by the presence of conductors such as reinforced concrete. We propose a very low frequency magnetic positioning system for a multistory parking garage that directly accounts for conductive objects such as the floors and walls by applying concepts from geophysical electromagnetic data inversion and forward modelling. This paper outlines the methodology of this approach, specifically the process of estimating the conductivity structure of a parking garage and using it to create models of the magnetic field propagating within, and concludes with an example of a real-life implementation with estimated positions.

## C5.3. GOIN - AN ACCURATE 3D INDOOR NAVIGATION FRAMEWORK FOR MOBILE DEVICES

Vlad Landa, Israel, udusaa@gmail.com - Boaz Ben-Moshe, Israel, benmo@g.ariel.ac.il  
Nir Shvalb, Israel, nirsh@ariel.ac.il - Shlomi Hacohen, Israel, hacohenshlomi@gmail.com

note  
book

*Key words: Visual Landmark Navigation and Mapping, Particle Filter, Android Sub-meter indoor position*

Performing a building-level positioning using WLAM and cellular information is a well-known methodology which was suggested and implemented by many researches. In this paper we present a general framework for accurate indoor positioning and navigation which improves the expected accuracy to a sub-meter error rate. The main algorithm is based on a modified particle filter which combines RF finger-printing, odometry, visual landmarks and map constrains. The accuracy improvement is achieved by using a low-resolution camera to track dominant landmarks such as lights. The use of “glowing-markers” allows one to accurately map relatively complex indoor buildings with a compact representation. The suggested method was implemented and tested on android based mobile devices. Our tests indicate a robust sub-meter 3D positioning at 10-30Hz with a fairly low energy consumption.

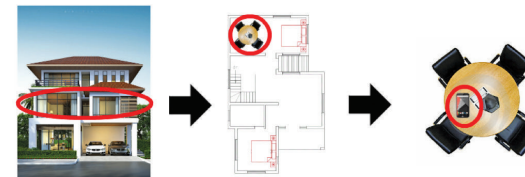

## C5.4. CONVOLUTIONAL NEURAL NETWORKS FOR POSITION ESTIMATION IN TDOA-BASED LOCATING SYSTEMS

Arne Niitsoo, Germany, arne.niitsoo@iis.fraunhofer.de  
 Thorsten Edelhäuser, Germany - Christopher Mutschler, Germany

**Key words:** TDoA-based localization, Deep learning, Channel impulse response

Object localization and tracking is essential for many applications including logistics and industry. Many local Time-of-Flight (ToF)-based locating systems use

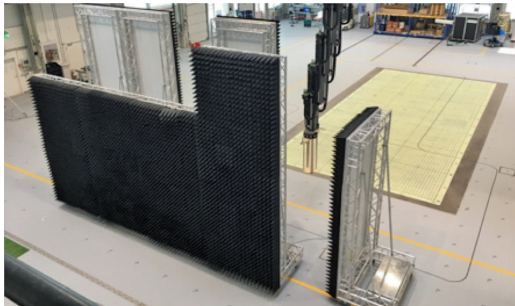

synchronized antennas to receive radio signals emitted by mobile tags. They detect the Time-of-Arrival (TOA) of the signal at each antenna and trilaterate the position from the Time Difference-of-Arrival (TDoA) between antennas. However, in multipath scenarios it is difficult to extract the correct ToA. This causes wrong positions. This paper proposes a signal processing method that uses deep learning to estimate the absolute tag position directly from the raw channel impulse response (CIR) data. We use the CIR together with ground truth positional data to train a convolutional neural network (CNN) that not only estimates non-linearities in the signal propagation space but also analyzes the signal for multipath effects. Our evaluation shows that our position estimation works in multipath environments and also outperforms classical signal processing in line-of-sight situations.

note book

## C5.5. MULTI-ROBOT MAPPING FOR OPTICALLY GUIDED VEHICLES

M.Sc. Preity Gupta, Germany, preity.gupta@iml.fraunhofer.de  
 M.Sc. Jana Jost, Germany, jana.jost@iml.fraunhofer.de  
 Benjamin Bordihn, Germany, bn.bo@beumergroup.com

note book

**Key words:** Multi-robot systems, Mapping, Distributed, Localization, Mobile robots

This paper addresses the problem of mapping and localization for optically guided Automated Guided Vehicles (AGV) that are widely needed in the warehousing industry. It describes an approach to build a floor plan of the optical path traversed by the AGV, while keeping the process cost-effective by using the AGVs internal sensors and the optical sensor used to keep track of the path. The idea is to create a distributed system where each AGV knows its location in the warehouse and is capable of calculating an optimal path when given a destination without having to map the environment prior. This is done through fusion of maps from multiple AGV. Each AGV creates its own map and communicates it to the mapping module which collects maps from all the AGV in the system and creates a fused map. Such a map needs to be robust against errors and noise from multiple AGV.

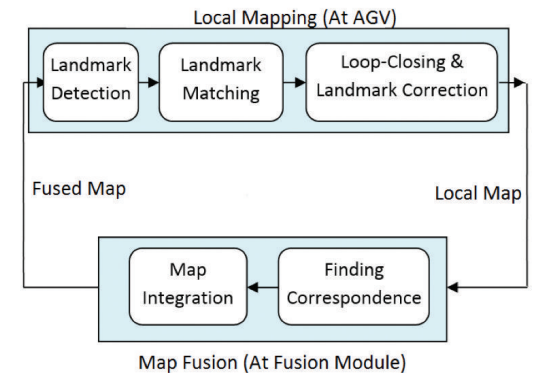

## C5.6. RSS-BASED MAP CONSTRUCTION FOR INDOOR LOCALIZATION

Ao Peng, China, pa@xmu.edu.cn - Tian Sun, China  
Wen Fu, China - Lingxiang Zheng, China - Biyu Tang, China

**Key words:** Indoor map construction, Hierarchical classification, Line segment feature map

Aimed at the problem of complex progress for indoor map building, this paper proposes an RSS-based indoor map construction algorithm only using information of WiFi fingerprint. The indoor map construction problem is then transformed into a classification problem of reference points in fingerprint database. With the aid of hierarchical classification system consisting of single-AP-based base classifier and multi-AP-based combination classifier, the accuracy of the classification results is guaranteed. Moreover, an accurate line segment feature map is obtained by identifying demarcation line between two classes from the hierarchical classification system. The simulation experiments are used to evaluate the effectiveness of the classification algorithm and the feasibility of the map construction algorithm.

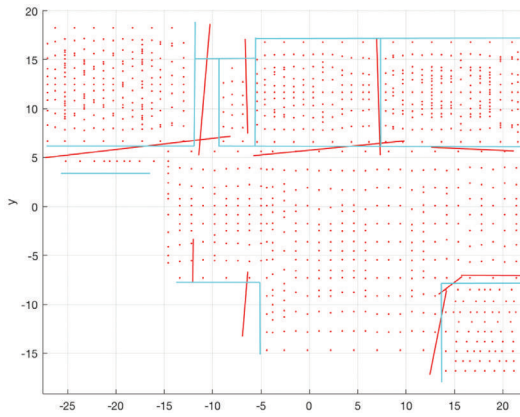

Line segment map after the same line merging

note  
book

## C6.1. ACCURATE AND PRECISE DISTANCE ESTIMATION FROM PHASE-BASED RANGING DATA

Yannic Schröder, Germany, schroeder@ibr.cs.tu-bs.de - Dennis Reimers, Germany - Lars Wolf, Germany

**Key words:** Distance estimation, Phase-based ranging, Active reflector

Many localization approaches need distance measurements to known locations as input. We present the Complex-valued Distance Estimation algorithm to compute the distance between two radio transceivers from phase measurements. Our proposed algorithm reliably computes the distance from a sampled phase response via Fast Fourier Transform. We compare the new approach with two other state-of-the-art algorithms by evaluating distance errors of real-world measurements in different scenarios. Our algorithm achieves high accuracy and precision with a mean error of 14.9 cm and

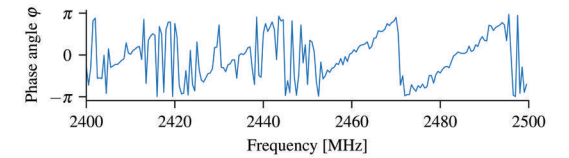

a standard deviation of 10.4 cm. Further, we evaluate the ability of all algorithms to detect outliers with large errors in their results. We optimize our approach to reduce computation complexity via interpolation without affecting accuracy or precision.

note  
book

## C6.2. EXPERIMENTAL EVALUATION OF A SINGLE ANCHOR MULTIPATH ASSISTED INDOOR ANGLE OF ARRIVAL LOCALIZATION SYSTEM IN THE 2.4 GHZ AND 5 GHZ BAND

Stijn Wielandt, Belgium, Stijn.wielandt@kuleuven.be - Bart Thoen, Belgium - Lieven De Strycker, Belgium

note  
book

*Key words: Indoor localization, Antenna array, Beamforming, Angle of arrival, Multipath, Ray tracing*

Indoor positioning systems are mostly supported by Radio Frequency (RF) technologies, due to the omnipresence of wireless communication infrastructure and handsets. Most of these localization systems rely on a Line Of Sight (LOS) connection to calculate a position based on signal strength, delay or direction. However, indoor environments are characterized by Non Line Of Sight (NLOS) connections and multipath effects such as reflections, scattering, diffraction and refraction. Multipath components are generally considered as undesirable and therefore most techniques focus on mitigation. This research applies an Angle of Arrival (AoA) multipath assistance approach, using ray tracing in a known environment to exploit signal reflections. Because the complete propagation channel is taken into account, a mobile node can already be localized by a single fixed antenna array. In order to assess the performance of the system, LOS and NLOS experiments are performed in three indoor environments in the 2.4 GHz and 5 GHz frequency bands. All measurements are processed by the multipath assisted AoA method, as well as a standard triangulation approach. These tests indicate the superior accuracy of the multipath assisted method, especially in NLOS conditions. Also, the tests demonstrate that the systems performs significantly better at 2.4 GHz than at 5 GHz. Finally, the performance of the presented system is compared to results that can be found in related work.

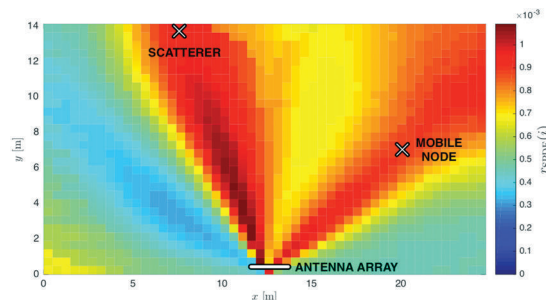

## C6.3. A COMPUTATIONALLY EFFICIENT METHOD FOR DIRECTION FINDING WITH KNOWN TRANSMIT SEQUENCE

Ziming Zhu, UK, ziming.zhu@toshiba-trel.com  
Mohammad Z. Bocus, UK, zubeir.bocus@toshiba-trel.com

note  
book

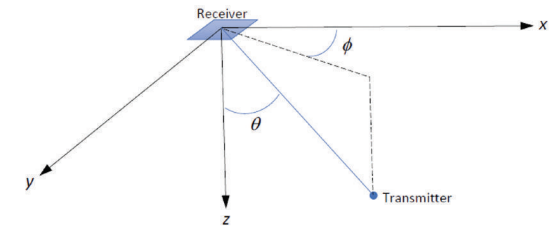

*Key words: Angle of arrival, Direction finding, Localisation, Bluetooth low energy*

Angle of arrival (AoA) estimation or direction finding (DF) has been extensively studied in the literature. Many existing AoA estimation algorithms perform a search over the entire angle space for the correct result. While such computational complexity is manageable in a number of scenarios, for future commercial small and low power wireless devices such as Bluetooth based internet of things (IoT) devices, the existing methods may not be feasible. This problem is exacerbated in 3D DF where the elevation angles also need to be computed. In this paper, a low complexity direction finding approach is presented which assumes that the transmit sequence is known. Under additive white Gaussian noise with zero mean, averaging the received sequence over multiple time instances 'filters' out the noise. The task of determining the azimuth and elevation angles then reduces to simpler operations. We show that the proposed method yields similar estimation accuracy as the conventional MUSIC algorithm in both free space single path as well as indoor multipath environments while needs much less computation. The proposed method may also be used in combination with existing algorithms developed for more complicated DF scenarios.

## C6.4. SUNDEW: DESIGN AND EVALUATION OF A MODEL-BASED DEVICE-FREE LOCALIZATION SYSTEM

Marco Cimdins, Germany, marco.cimdins@fh-luebeck.de

Mathias Pelka, Germany, mathias.pelka@fh-luebeck.de · Horst Hellbrück, Germany, hellbrueck@fh-luebeck.de

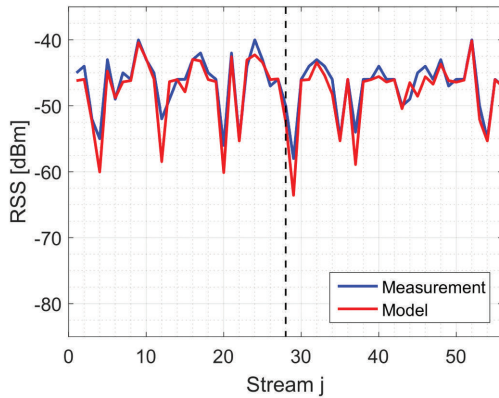

note  
book

**Key words:** Device-free localization, Signal Strength Based Methods, Algorithms for WSNs

The state-of-the-art in device-free localization systems based on RF-measurements is fingerprinting. Fingerprinting requires reference measurements called fingerprints that are recorded during a training phase. Especially in device-free localization systems, recording of reference measurements for fingerprinting is a tedious, costly, and error-prone task. In this paper, we propose Sundew, a model-based device-free localization system that does not need fingerprinting in the sense of reference measurements but is able to calculate signal strength values at any position and compare it to actual measurements after a simple calibration phase. Sundew – as any device-free localization system – requires a metric for comparison of feature vectors. In this paper, we investigate the influence of nine different distance metrics on the positioning accuracy. Simulations and measurements show that our suggested model-based device-free localization system works best with the L1 distance metric. Sundew estimates 90% of positions in a 2.5m x 2.5m grid correctly, independent of the orientation of the person in the target area.

## C6.5. PROPOSAL FOR IMES TRANSMITTERS USING LOCATION INFORMATION CODE

Takamasa Kawaguchi, Hitachi Ltd., Tokyo University of Marine Science and Technology, Japan

Kenjiro Fujii, Hitachi Industrial Equipment Systems Co., Ltd., Japan

Makoto Tanikawara, Hitachi Industrial Equipment Systems Co., Ltd., Japan

Nobuaki Kubo, Tokyo University of Marine Science and Technology, Tokyo, Japan

note  
book

**Key words:** IMES, Seamless positioning system, GPS/GNSS, Location Information, Code/ucode, LBS, Location spoofing

A “Location Information Code” is a unique code number to identify the medium providing location information and divide true space into approximately 3m mesh by the Geospatial Information Authority of Japan. Indoor Messaging System (IMES) is a seamless positioning technology in the indoor and outdoor environment, IMES signal transmitter in indoor environment broadcasts the location information. In this paper, the location information management of IMES signal transmitters to the assignment rule of Location Information Code and activation IMES signal transmitters is discussed. A solution method of applying the Location Information Code for IMES is proposed. These findings contribute further to development of a practical seamless positioning system.

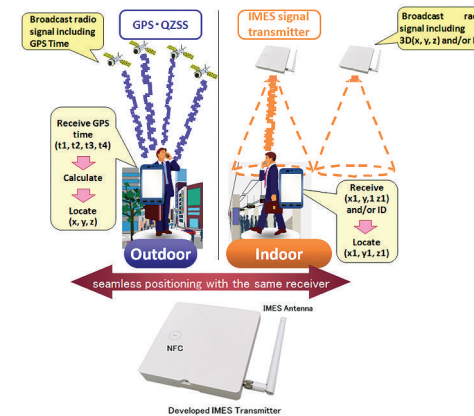

Overview of Location Information Code

Information LSB compare with Location Information Code and IMES

Item	Latitude	Longitude
Location Information Code	LSB:0.1[sec] <sup>23</sup>	LSB:0.1[sec] <sup>24</sup>
IMES	Position 1	LSB:180(deg) <sup>23</sup> LSB:360(deg) <sup>24</sup>
	Position 2	LSB:180(deg) <sup>24</sup> LSB:360(deg) <sup>23</sup>



# C7.1. FINGERPRINTING METHOD FOR ACOUSTIC LOCALIZATION USING LOW-PROFILE MICROPHONE ARRAYS

Bart Thoen, Belgium, bart.thoen@kuleuven.be - Stijn Wielandt, Belgium - Lieven De Strycker, Belgium

note book

**Key words:** Acoustic fingerprinting, Indoor localization, Microphone array

Indoor localization of unknown acoustic events with MEMS microphone arrays have a huge potential in applications like home assisted living and surveillance. This article presents an Angle of Arrival (AoA) fingerprinting method for use in Wireless Acoustic Sensor Networks (WASNs) with low-profile microphone arrays. In a first research phase, acoustic measurements are performed in an anechoic room to evaluate two computationally efficient time domain delay-based AoA algorithms: one based on dot product calculations and another based on dot products with a PHase Transform (PHAT). The evaluation of the algorithms is conducted with two sound events: white noise and a female voice. The algorithms are able to calculate the AoA with Root Mean Square Errors (RMSEs) of 3.5° for white noise and 9.8° to 16° for female vocal sounds. In the second research phase, an AoA fingerprinting algorithm is developed for acoustic event localization. The proposed solution is experimentally verified in a room of 4.25m by 9.20m with 4 acoustic sensor nodes. Acoustic fingerprints of white noise, recorded along a predefined grid in the room, are used to localize white noise and vocal sounds. The localization errors are evaluated using one node at a time, resulting in mean localization errors between 0.65m and 0.98m for white noise and between 1.18m and 1.52m for vocal sounds.

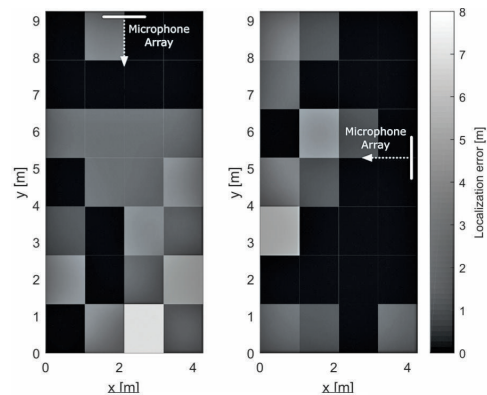

# C7.2. A REVIEW OF MULTIDIMENSIONAL SCALING TECHNIQUES FOR RSS-BASED WSN LOCALIZATION

Fernando Seco, Spain, fernando.seco@csic.es - Antonio R. Jiménez, Spain - Pekka Peltola, Spain

note book

**Key words:** Wireless sensor networks, Positioning, Multidimensional scaling, RSS

Mobile nodes with sensing, computing and communicating capabilities are usually deployed in indoor environments as wireless sensor networks (WSN) for internet-of-things applications. Proper interpretation of the data acquired by these sensor networks requires an estimate of their location. Among the currently existing positioning methods for WSN, multidimensional scaling (MDS) is a computationally efficient technique based on empirical measurement or estimation of the ranges between the nodes. This communication describes and evaluates several versions of MDS localization methods, particularly applied to indoor networks based on transmission of

radiofrequency signals and measurement of the received signal strengths (RSS). The positioning accuracy, resistance to measurement noise, and computation times are analyzed and commented within a common framework.

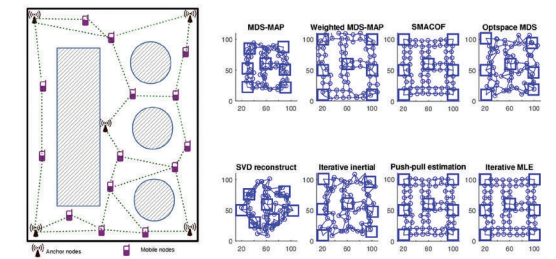



# C7.5. PERFORMANCE COMPARISON OF RSS ALGORITHMS FOR INDOOR LOCALIZATION IN LARGE OPEN ENVIRONMENTS

Nico Podevijn, nico.podevijn@ugent.be - David Plets - Jens Trogh - Luc Martens - Wout Joseph, Department of Information Technology, University of Ghent/IMEC, WAVES, Ghent, Belgium  
 Abdulkadir Karaagac - Jetmir Haxhibeqiri - Jeroen Hoebeke  
 Department of Information Technology, University of Ghent/IMEC, IDLab, Ghent, Belgium  
 Aucxis cvba, Stekene, Pieter Suanet, Belgium

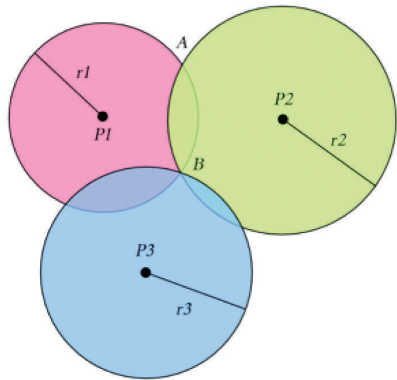

**Key words:** LoRA, BLE, RSS, Localization, Algorithm, Open environment, Industry  
 We develop and benchmark four RSS localisation algorithms where different a priori knowledge is required. The selection of the best algorithm depends on the availability of additional information on path loss exponent and/or transmit power. We compare our algorithms with centroid localization and show that the algorithms provide better results for shadowing on the values not exceeding 6dB. We perform experiments and simulations with Bluetooth Low Energy and LoRaWAN technologies and select the best technology and algorithm for localisation in large open industrial environments.

note  
book

---



---



---



---



---



---



---



---



---



---



---



---



---



---



---



---



---



---



---



---



---



---

CONNECTED INTELLIGENT URBAN MOBILITY

**HEXATRONIC**, chasseur de Bugs

Expert en analyse de dysfonctionnements,

Crée et adapte votre électronique de A à Z avec les logiciels associés,

Vos projets électroniques ne doivent pas finir comme ça...

**HEXATRONIC - Pays de la Loire : olivier.veron@hexatronic.fr - 06.09.42.27.00**

- ◆ Relève les défis des produits non abouti ou qui ne fonctionnent pas comme souhaité.
- ◆ Concrétise avec vous vos idées de produits électroniques et le soft attaché.
- ◆ Apporte les solutions permettant un fonctionnement fiable et durable de vos produits.

# SP1.1. DYNAMIC BEAM SELECTION FOR BEAM-RSRP BASED DIRECTION FINDING IN MMW 5G NETWORKS

Elizaveta Rastorgueva-Foi, Finland, elizaveta.rastorgueva-foi@tut.fi - Mário Costa, Finland  
 Mike Koivisto, Finland - Kari Leppänen, Finland - Mikko Valkama, Finland

**Key words:** 5G networks, Beamforming, RSRP, Positioning, Localization, Tracking, Direction-of-departure, Location-awareness, Extended Kalman filter, Sequential estimation, Line-of-sight

This paper considers direction-finding in millimeter wave (mmW) fifth generation (5G) networks by means of beam-based downlink (DL) reference signal received power (RSRP) measurements and subsequent reporting. In particular, we propose two methods that allow user equipments (UEs) to select, in an independent and dynamic manner, the most-relevant beam-RSRP (BRSRP) measurements as a trade-off between angle-related information and load of the feedback channel. A likelihood ratio (LR)-test is derived in which the hypothesis for "noise-only" BRSRP measurement is compared to that of "reference signal (RS)-plus-noise" observations, under a given significance level. A power threshold based method is also proposed in which the BRSRP measurements are compared to a threshold proportional to the noise power.

Such a noise variance is estimated at each UE independently. The performance of the proposed beam selection schemes is assessed by means of an extended Kalman filter (EKF) tracking the direction of departure (DoD) of the line-of-sight (LoS) path between base stations (BSs) and a UE. Extensive numerical results are provided on a realistic mmW 5G outdoor deployment scenario operating at 39 GHz and with a ray-tracing propagation model based on the METIS Madrid grid.

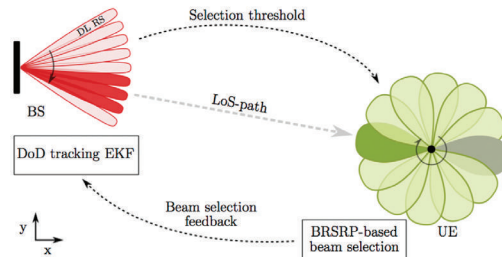

note book

# SP1.2. RSS-BASED DOA ESTIMATION USING ESPAR ANTENNA RADIATION PATTERNS SPLINE INTERPOLATION

M. Groth, Poland, mateusz.groth@eti.pg.gda.pl  
 K. Nyka, Poland - L. Kulas, Poland

**Key words:** Switched-beam antenna, ESPAR antenna, Direction-of-arrival (DoA), Received signal strength (RSS), Interpolation algorithm

In this paper, it is shown how power pattern cross-correlation (PPCC) algorithm, which relies on received signal strength (RSS) values recorded at electronically steerable parasitic array radiator (ESPAR) antenna output port, used for direction-of-arrival (DoA) estimation, can easily be improved by applying spline interpolation to radiation patterns recorded in the calibration phase of the DoA estimation process. The proposed method allows one to measure ESPAR antenna's radiation patterns during the initial calibration phase with much coarser angular resolution than required for linearly interpolated radiation patterns. Simulation results indicate that the overall DoA estimation accuracy can be kept at the similar level even for a few number of points, which, when applied in anechoic chamber calibration procedure of wireless sensor network (WSN) nodes equipped with ESPAR antennas, will have a noticeable influence on the overall calibration time and therefore also on deployment costs in practical WSN applications.

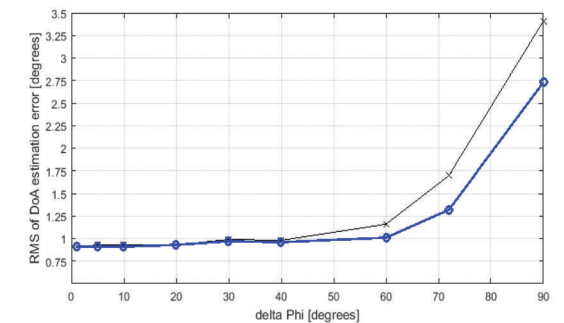

## SP1.3. EXPERIMENTAL PERFORMANCE EVALUATION OF OUTDOOR TDOA AND RSS POSITIONING IN A PUBLIC LORA NETWORK

D. Plets, Belgium, david.plets@ugent.be - N. Podevijn, Belgium - J. Trogh, Belgium - L. Martens, Belgium - W. Joseph, Belgium

note book

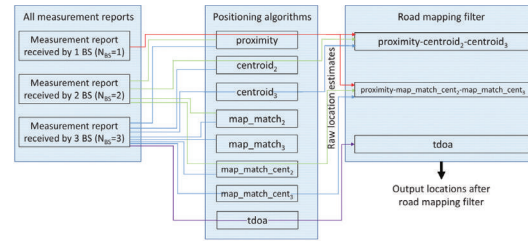

**Key words:** LoRa, RSS, Localization, TDoA, Positioning, Outdoor, Experimental, Algorithm

This paper experimentally compares the positioning accuracy of TDoA-based and RSS-based localization in a public outdoor LoRa network in the Netherlands. The performance of different Received Signal Strength (RSS)-based approaches (proximity, centroid, map matching,...) is compared with Time-Difference-of-Arrival (TDoA) performance. The number of RSS and TDoA location updates and the positioning accuracy per spreading factor (SF) is assessed, allowing to select the optimal SF choice for the network. A road mapping filter is applied to the raw location estimates for the best algorithms and SFs. RSS-based approaches have median and maximal errors that are limited to 1000m and 2000m respectively, using a road mapping filter. Using the same filter, TDoA-based approaches deliver median and maximal errors in the order of 150m and 350m respectively. However, the number of location updates per time unit using SF7 is around 10 times higher for RSS algorithms than for the TDoA algorithm.

## SP1.4. BLUETOOTH-BASED INDOOR POSITIONING THROUGH TOF AND RSSI DATA FUSION

Davide Giovanelli, Fondazione Bruno Kessler (FBK), Trento, Italy, dgiovanelli@fbk.eu

Elisabetta Farella, Fondazione Bruno Kessler (FBK), Trento, Italy, efarella@fbk.eu

Daniele Fontanelli, daniele.fontanelli@unitn.it - David Macii david.macii@unitn.it, University of Trento, Trento, Italy

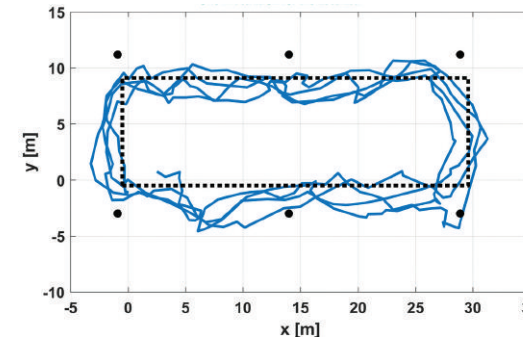

note book

**Key words:** Indoor positioning, Bluetooth Low Energy, Time-of-Flight (ToF), Kalman filter, Data fusion

After several decades of both market and scientific interest, indoor positioning is still a hot and not completely solved topic, fostered by the advancement of technology, pervasive market penetration of mobile devices and novel communication standards. In this work, we propose a two-step model-based indoor positioning algorithm based on Bluetooth Low-Energy, a pervasive and energy efficient standard protocol. In the first (i.e. ranging) step a Kalman Filter (KF) performs the fusion of both RSSI and Time-of-Flight measurement data. Thus, we demonstrate the benefit of not relying only on RSSI, comparing ranging performed with or without the help of ToF. In the second (i.e. positioning) step, the distance estimates from multiple anchors are combined into a quadratic cost function, which is minimized to determine the coordinates of the target node in a planar reference frame. The proposed solution is tailored to reduce the computational effort and target real-time execution on an embedded platform, demonstrating a limited loss of performance. The paper presents an experimental setup and discusses meaningful results, demonstrating a robust BLE-based indoor positioning solution for embedded systems.

# SP1.5. SUPER-RESOLUTION IN RSS-BASED DIRECTION-OF-ARRIVAL ESTIMATION

Thorsten Nowak, Germany, thorsten.nowak@fau.de  
 Markus Hartmann, Germany - Jörn Thielecke, Germany  
 Niels Hadaschik, Germany - Christopher Mutschler, Germany

**Key words:**

For the evolving Internet-of-Things, ubiquitous positioning is a core feature. Hence, energy- and location-awareness are essential properties of wireless sensor networks (WSNs), today. received signal strength (RSS)-based localization techniques are superior in terms low power

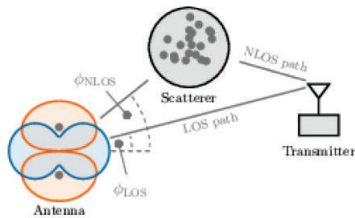

consumption. Therefore, RSS-based direction finding is prospective approach to location-aware, low-power sensor nodes. However, RSS-based direction-of-arrival (DOA) estimation is prone to multipath propagation. In this paper, a subspace-based approach to frequency-domain multipath resolution is presented. Resolution of multipath components allows for RSS-based DOA estimation considering the power of the line of sight (LOS) component only. The impact of the multipath channel is considerably reduced applying the presented multipath resolution approach. In contrast to common broadband DOA estimation techniques, the presented approach does demand for phase coherent receive channels nor for a synchronized sensor network. Hence, the proposed super-resolution technique is applicable to low-power sensor networks and brings accurate positioning to small-sized and energy-efficient sensor nodes.

**note book**

.....

.....

.....

.....

.....

.....

.....

.....

.....

.....

.....

.....

.....

.....

.....

.....

.....

.....

.....

.....

.....

.....

.....

# SP2.1. PERFLOC (PART 2): PERFORMANCE EVALUATION OF THE SMARTPHONE INDOOR LOCALIZATION APPS

Nader Moayeri, USA, nader.moayeri@nist.gov  
 Chang Li, USA - Lu Shi, USA

**Key words:** *Indoor localization, Smartphone sensor data, Smartphone apps, Android, PerfLoc*

This paper describes the structure of the PerfLoc Prize Competition organized by the US National Institute of Standards and Technology (NIST). The Competition consisted of collecting an extensive repository of smartphone data, releasing the data to researchers across the world to develop smartphone indoor localization algorithms, allowing them to evaluate the performance of their algorithms using a NIST web portal, and rigorous, live testing of the Android apps implementing the best algorithms at NIST. The paper presents detailed performance analysis of the algorithms developed by the top 10 participants as well as the Android indoor localization app that

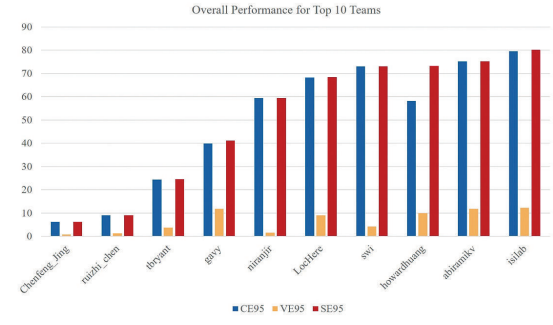

won the first prize in PerfLoc. It also provides a comparison of PerfLoc with other ongoing, annual indoor localization competitions.

**note book**

.....

.....

.....

.....

.....

.....

.....

.....

.....

.....

.....

.....

.....

.....

.....

.....

.....

.....

.....

.....

.....

.....

## SP2.2. REVIEW OF PDR CHALLENGE IN WAREHOUSE PICKING AND ADVANCING TO XDR CHALLENGE

Ryosuke Ichikari, Japan, r.ichikari@aisit.go.jp - Ryo Shimomura, Japan  
Masakatsu Kourogi, Japan - Takashi Okuma, Japan - Takeshi Kurata, Japan

*Key words: PDR challenge, xDR challenge, Competition, Warehouse operations*

In this paper, we present a review of the competition track organized by us at IPIN 2017. Our competition track was named as “PDR challenge in warehouse picking”. Our pedestrian dead-reckoning (PDR) challenge focused on testing the PDR methods under a realistic scenario, which is tracking employees during the picking operation in a warehouse. Firstly, we introduce an overview of the PDR challenge including detailed information of all evaluation metrics. Secondly, we summarize the results and findings from the competition and list the challenges that should be tackled in the next competition. Thirdly, we introduce the design concept of an xDR challenge by reflecting the findings and feedback of design of the competition. The target of the PDR challenge was only the employees who move by foot during working in the warehouse. The main update in the xDR challenge is dealing with forklifts driven by employees as well as walking employees. We term dead-reckoning of a vehicle as vehicle dead-reckoning (VDR). The term xDR is derived from PDR plus VDR. Another update is providing reference data for the reconstructing situation of picking operation in the warehouse by using an IMU-based motion capture system.



note  
book

SPECIAL SESSIONS

**DISCOVER  
THE FUTURE  
OF GNSS  
RECEIVER  
TECHNOLOGY**

Download now  
the new **GSA GNSS User  
Technology Report**  
<http://GNSS-Tech-Report.gsa.space>

  
**GALILEO** EGNOS  
NAVIGATION SOLUTIONS  
POWERED BY EUROPE

  
 European  
**Global Navigation  
Satellite Systems  
Agency**



To learn more about the features of the most precise GNSS in the world, visit us at **IPIN 2018, Stand 1**

# Poster session

- 209619 Collaborative Stereo Configuration of Master and Satellite Unmanned Air Vehicles for a Dynamic Baseline  
*Andreas Sutorma, Jörg Thiem*
- 209895 Robust indoor positioning based on BLE beacons  
*Cheng Wang, Yu Zhao*
- 210144 Investigation of Indoor Localization with Room Level Accuracy using Invisible Access Points  
*Yan Li, Bill Moran, Allison Kealy, Simon Williams, Guenther Retscher*
- 211108 Trackable Visible Light Beaconing and Detection for Indoor Localization Applications Using Undersampling Cameras  
*Márk Rátosi, Gyula Simon*
- 212187 A Two-Dimensional Indoor Location Algorithm Based on Weighted Factor Adjustment and Multi-Channel Pseudolite Carrier Phase Difference  
*Ruihui Zhu, Yunjia Wang*
- 212208 WLAN Indoor Ranging Dataset for Evaluation of Time of Arrival Estimation Algorithms  
*Ahmed Makki, Chris Bleakley*
- 212290 Indoor Positioning Technology Based on Particle Filter Fusion  
*Huang Lu, Gan Xingli*
- 212299 Positioning Algorithms for Indoor Navigation Using Sensors Fusion  
*Levgen Gorovyi, Feliks Sirenko, Alexey Roienko, Yevhen Chervoniak*
- 212304 Real Time Positioning System for two UAVs via ToF Camera  
*José Antonio Paredes, Fernando Javier Álvarez, Teodoro Aguilera, Juan Diego Gutiérrez, José Antonio Moreno*
- 212368 Leveraging Gyroscopes for Estimating Heading Directions of Smartphone Users  
*Myeongcheol Kwak, Minhyeok Kang, Taeheon Park, Ted "Taekyoung" Kwon*
- 212375 Radio Map Optimization Through Unsupervised Learning for Indoor Localization  
*Jens Trogh, Wout Joseph, Luc Martens, David Plets*
- 212511 Effects of GNSS spoofing on the clock of a GNSS receiver  
*Victor Truong, Nel Samama, Alexandre Vervisch-Picois*
- 212520 Collaborative Clock Synchronization and Ranging Protocol to Support Local Positioning Systems in WSN  
*Daniel Albuquerque, José Vieira, Francisco Teixeira, Sérgio Lopes*
- 212616 Parking-Lot Localization  
*Roi Yozevitch, Arkady Gorodischer, Boaz Ben-Moshe*
- 212630 Impact of calibration on indoor positioning precision  
*Xavier Tolza, Pascal Acco, Jean-Yves Fourniols*
- 212654 Indoor Location Surveying With Smart Phones  
*Ying Zhang, Michael Chiu, Robert Fraser, Chetan Bhadracha, Bhaskar Mehta, Gabriel Leblanc*
- 212670 STEPS - InDoor Navigation Framework for Mobile Devices  
*Yael Landau, Boaz Ben-Moshe, Revital Marbel*
- 212679 MDIRECT: Magnetic field strength and peDestrian dead RECKoning based indoor localizaTion  
*Imran Ashraf, Soojung Hur, Muhammad Usman Ali, Yongwan Park*
- 212720 Real-time Wi-Fi RSS Variation Correction Using a Network Differential Positioning Approach  
*Guenther Retscher, Yan Li, Allison Kealy, Hannes Hofer, Jelena Gabela, Salil Goel, Omair Qureshi, Elizabeth Smith, Lina Bao*
- 212724 How to Detect Floor Change in Building Using Smartphone  
*Sangjae Lee, Dongsoo Han*
- 212808 3D Position Estimation of an UAV in Indoor Environments using an Ultrasonic Local Positioning System  
*David Gualda, Jesús Ureña, María del Carmen Pérez, Hans Posso, Sergio Bachiller, Rubén Nieto*
- 212847 RF-Based Safety-Critical Hybrid Localization  
*Mathias Pelka, Marco Cimdins, Horst Hellbrück*
- 212926 Low Power Ultrasound Location System for Secure Identification  
*Chesney Buyle, Bert Cox, Liesbet Van der Perre*



- 212958 Constellations of Active UHF-RFID Tags for Indoor Positioning  
*Hatem Elias, Elizabeth Colin, Sara Abou-Chakra, Bachar El-Hassan, Jean-Marc Laheurte*
- 212975 Azimuth Detection Using Flicker-Free Visible Light Communication with a Low Frame-Rate Camera  
*Yohei Nakazawa, Hideo Makino*
- 213044 Experiment Design for Ultra-wideband Sensor Node Calibration  
*Andreas De Preter, Jan Anthonis, Jan Swevers, Goele Pipeleers*
- 213059 A framework for multisensor positioning and navigation in underground mines  
*Vincenzo Di Pietra, Marco Piras, Laura Ruotsalainen, Jesperi Rantanen, Tuomo Malkamaki*
- 213063 Location Awareness and Context Detection for hand-held Tools in Assembly Processes  
*Jochen Seitz, Christian Nickel, Tonia Christ, Piotr Karbownik, Thorsten Vaupel*
- 213070 Activity recognition from stride detection: a machine learning approach based on geometric patterns and trajectory reconstruction  
*Bertrand Beaufils*
- 213149 Using Cooperatively Applied Positioning Techniques Utilizing Range Extension to Manage Passengers in Crowded Environments.  
*Gary Cullen, Marinus Toman*
- 213163 Indoor Localization Application based on WLAN Fingerprinting with Received Signal Strength (RSS)Frequency Distribution Scheme  
*Mai Abd El-Halim, Hadia El-Hennawy, Adel Mounir Said*
- 213173 Contribution to Frailty Diagnosis based on Activity and Behaviour Recognition using an IMU  
*David Gualda, Juan Jesús García, Ana Jiménez, Dina Bousdar, Estefanía Muñoz*
- 213210 Testing an Ultrasonic Local Positioning System for 3D Spaces  
*Khaoula Mannay*
- 213213 Contactless real-time analysis of elderly people posture for sleep disorders evaluation  
*Alberto Garcia, Cristina Losada, Sara Garcia, Ana Jiménez, J. Jesus Garcia*
- 213219 Improving Bluetooth-based Indoor Positioning Using Artificial Networks  
*Sharareh Naghdi, Kyle O'Keefe*
- 213221 Visible Light Positioning for Smartphones Based on Biphasic Mark Coding: A Proof of Concept  
*Juan D. Gutiérrez, Fernando J. Álvarez, Teodoro Aguilera, José A. Paredes, Jorge Morera*
- 213244 Evaluating Performance of Human Identification using MIMO Array  
*Dai Sasakawa, Naoki Honma, Takeshi Nakayama, Shoichi Iizuka*
- 213251 Smartphone-based Inertial Navigation System Using Step Length and Walking Direction  
*Ho Jin Ju, So Young Park, Chan Gook Park*
- 213255 In and Out Detection of Users in Indoor Malls Using Wi-Fi signals  
*Daehyun Kang, Dongsoo Han*
- 213266 Quasi-static Magnetic Field Aided Adaptive Foot-mounted PDR  
*So Young Park, Ho Jin Ju, Chan Gook Park*
- 213284 A Smartphone Short-Range Path Estimation Method using Spinning Magnet Marker  
*Kosuke Watanabe, Kei Hiroi, Katsuhiko Kaji, Nobuo Kawaguchi*
- 213327 MIMU PDR with bias estimation using an optimization-based approach  
*Henk Kortier, Wilco Bonestroo, Ronald Tangelder*
- 213419 Unsupervised Channel Annotation For Bluetooth Low Energy Advertisement RSSI  
*Rahul Majethia, Krishnan Rajkumar*

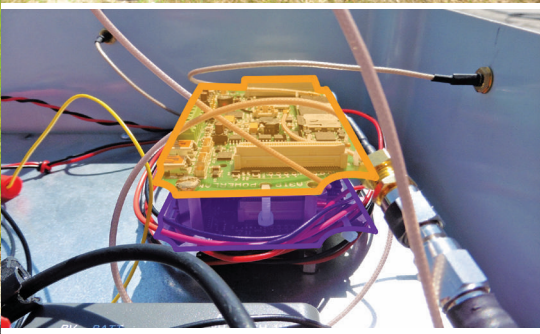



**Scientists go shopping!** Our competitors face real indoor positioning and navigation challenges in a shopping mall.

3.

**Competition**



# IPIN 2018 Indoor Localization Competition

The competition is held in the course of the IPIN 2018 Conference at the city of Nantes. This competition is a unique opportunity to solve remaining issues in your GEO-IOT, Location Based Services or other geolocation applications in a dynamic real environment.

## LOCATION

The competition takes place at one of the largest shopping mall in Western France: *Atlantis le Centre*. The shopping mall contains several wide corridors, open areas, large parking areas, more than 150 shops, more than 30 restaurants, an IKEA furniture store and a supermarket. This year competition has a very special feature: the teams compete while regular center customers are shopping in the midst of the seasonal sales.

## FOUR COMPETITION TRACKS

IPIN 2018 Indoor Localization Competition consists of four independent challenging tracks, including two on-site and two off-site contests, where the accuracy of the competing

systems is evaluated using the “black-box testing” approach on each track.

The proposed competition tracks in 2018 are:

- Track 1 “Camera based Positioning (on-site)”
- Track 2 “Non Camera based Positioning (on-site)”
- Track 3 “Smartphone based Positioning (off-site)”
- Track 4 “Foot-Mounted IMU based Positioning (off-site)”

## COMPETITORS

A “competitor” can be any individual or group of individuals working as a single team, associated to a single or a number of organizations.

There are two types of competitors in this competition:

- The 1<sup>st</sup> ones come to *Atlantis center* to gather data inside the shopping mall and deliver it to the evaluation jury. This regards tracks 1&2.
  - The 2<sup>nd</sup> ones retrieve data from the organizers and construct a path with the best precision before delivering it to the competition chairs. This regards tracks 3&4.
- This year 39 teams from 15 countries compete with each other using their innovative technologies. The competition chairs will decide which team proved its technology the best.

## IPIN 2018 COMPETITION'S CONTEXT

The competition tracks cover about 9 000 m<sup>2</sup> of the shopping mall, including staircases, escalators and other facilities common in shopping centers. The entire shopping mall was scanned on 4 different levels, including open floors



4 tracks

39  
teams

9 000 m<sup>2</sup>  
of competition  
surface

and underground parking. The mobile mapping part was conducted by the company VIAMETRIS, who used the 6DOF LIDAR SLAM and cameras of the bMS3D whose system was selected to map the ground truth of all foot tracks used for the off-site and on-site competition. It scanned and measured the coordinates of nearly 200 key points that constitute the ground truth.

## COMPETITION DESIGN

*What's the difference between on-site and off-site competition?*

### Tracks 1 and 2

The goal of these competition tracks is to evaluate the performance of different indoor localization solutions in realtime mode during the evaluation day – the 22<sup>nd</sup> of September. Evaluation path is set up by the organizers at the opening time of the mall. Since the competition takes place in a shopping mall, only infrastructure-free localization technologies can compete. Indeed, it is not possible to install any specific equipment (any kind of hardware that could help their device to compute location estimates, for example, no iBeacons, no BLE, etc.) in this private environment. All suggested for competition systems must be self-contained working solutions and the competitors cannot deploy their own infrastructure for positioning purposes in the on-site tracks. The equipment should be carried on the upper part of the human body, including trouser pockets.

### Tracks 3 and 4

These tracks are done off-site, that means navigation solutions have to be post-processed. All data for calibration and evaluation is provided by competition organizers before the celebration of the IPIN conference. The competition teams can calibrate their algorithmic models with several databases containing readings from sensors typically found in modern mobile phones and some ground-truth positions. Finally, each team competes using additional database files, but in this case the ground-truth reference is not given and must be estimated by the competitors. This is an off-line competition where all competitors have the same data of the testing environment, so custom on-site calibration is not allowed. Competitors can only use the data provided for the competition. After processing the evaluation logfiles, participants must submit the position estimates to the contact points of the corresponding track. A participant team can upload up to 3 different contributions, which are evaluated by the competition organizers. Although the three alternatives are evaluated on the final test set, only the best one is considered for the contest.



## Acknowledgements and awards

Results of the competition will be announced the last day of the IPIN2018 conference, i.e., the 27<sup>th</sup> of September in the morning at the award ceremony.

The best team in each track will be awarded the following prizes by the shopping mall *Atlantis center*:  
**1000€ for 1<sup>st</sup> place in each of four tracks**

The top 3 teams of each track are giving a presentation to the audience about the system they used and algorithm developed.



# IPIN 2018 Competition Teams



## 17 on-site competition teams

### Track 1 “Camera based Positioning (on-site)”

#### TEAM GOOGLE

*Team leader:* Ying Zhang  
*Organisation:* Google

#### TEAM XMU

*Team leader:* Wen Fu  
*Organisation:* School of Information Science and Engineering Xiamen University

#### TEAM ARIEL-1

*Team leader:* Vlad Landa  
*Organisation:* Computer Science, Ariel University, Israel

#### TEAM ARIEL-2

*Team leader:* Boaz Ben-Moshe  
*Organisation:* Computer Science, Ariel University, Israel

#### TEAM ETRI

*Team leader:* Blagovest Vladimirov  
*Organisation:* ETRI (Electronics and Telecommunications Research Institute)

### Track 2 “Non-Camera based Positioning (on-site)”

#### TEAM SONY

*Team leader:* Takahiro Tsujii  
*Organisation:* Sony Japan

#### TEAM CLE

*Team leader:* Niki Trigoni  
*Organisation:* Core Location Engine (CLE)

#### TEAM TJU

*Team leader:* Yu Liu  
*Organisation:* Tianjin University

#### TEAM UPJS

*Team leader:* Miroslav Opiela  
*Organisation:* P. J. Šafárik University, Košice, Slovakia

#### TEAM IDRISITech

*Team leader:* Loai Abdallah  
*Organisation:* IDRiSi

#### TEAM SNU

*Team leader:* Chan Gook Park  
*Organisation:* Seoul National University

#### TEAM TUM

*Team leader:* Georgios Pipelidis  
*Organisation:* Technical University Of Munich

#### TEAM KYUSHU

*Team leader:* Chuanhua Lu  
*Organisation:* Kyushu University, Fukuoka, Japan

#### TEAM ETRI

*Team leader:* Soyeon Lee  
*Organisation:* Electronics and Telecommunications Research Institute

#### TEAM MSU

*Team leader:* Alexander Mikoff  
*Organisation:* Lomonosov Moscow State University

#### TEAM BTX

*Team leader:* Chenfeng Jing  
*Organisation:* Beijing Xihe Technology Co. Ltd

#### TEAM FINEWAY

*Team leader:* Ming Lyu  
*Organisation:* Fineway

## 22 off-site competition teams

### Track 3 “Smartphone based Positioning (off-site)”

#### TEAM ARARADS

*Team leader:* Tomás Lungenstrass  
*Organisation:* AraraDS, Arara Chile

#### TEAM HFTS

*Team leader:* Stefan Knauth  
*Organisation:* Stuttgart University of Applied Sciences - HFT Stuttgart

#### TEAM FIVE WHU

*Team leader:* Zheng Xingyu  
*Organisation:* University Wuhan

#### TEAM TENCENT

*Team leader:* Chang Liu  
*Organisation:* Tencent

#### TEAM XMU

*Team leader:* Tian Sun  
*Organisation:* Xiamen University Xiamen

#### TEAM CLE

*Team leader:* Niki Trigoni  
*Organisation:* Core Location Engine (CLE)

#### TEAM CLIPS

*Team leader:* Musmanali  
*Organisation:* mClips: Mobile Communication Lab Indoor Positioning System

#### TEAM LUND

*Team leader:* Martin Larsson  
*Organisation:* Lund University and Combain Mobile AB

#### TEAM IDRISITech

*Team leader:* Loai Abdallah  
*Organisation:* IDRiSi

#### TEAM MSU

*Team leader:* Sasha Mikoff  
*Organisation:* Lomonosov Moscow State University

#### TEAM TUM

*Team leader:* Nikolaos Tsiamitros  
*Organisation:* Technical University Of Munich

#### TEAM YAI

*Team leader:* Shi-Shen Yang  
*Organisation:* University, Zhongli

#### TEAM TRIMBLE

*Team leader:* Srujan Babu  
*Organisation:* Trimble

#### TEAM IBM

*Team leader:* Yiannis Gkoufas  
*Organisation:* IBM Research

#### TEAM IOT2US

*Team leader:* Zixiang Ma  
*Organisation:* Queen Mary University of London

#### TEAM UGENT

*Team leader:* Jens Trogh  
*Organisation:* Ghent University

#### TEAM EGEC

*Team leader:* Feng Xu  
*Organisation:* E-Government Engineering Center

### Track 4 “Foot-Mounted IMU based Positioning (off-site)”

#### TEAM KIT

*Team leader:* Nicolai Kronenwett  
*Organisation:* Karlsruhe Institute für Technologie

#### TEAM TJU

*Team leader:* Liqiang Zhang  
*Organisation:* Tianjin University

#### TEAM WHU

*Team leader:* Li Yu  
*Organisation:* Wuhan University

#### TEAM YZU

*Team leader:* Fu-Kai Chuang  
*Organisation:* University Taiwan

#### TEAM AOE.AC.CN

*Team leader:* Wenchao Zhang  
*Organisation:* University of Chinese Academy of Sciences



Syntony has been chosen by the metro of

**Stockholm**  
The Capital of Scandinavia



**SubWave**

**The most effective solution for Underground & Confined environment Location**

### Challenges

- Tracking precisely professional receivers
- Locate emergency calls without installing an «app» (ref E911)
- Locate trains & other systems

### Solutions

- Seamless transition between outdoor and indoor
- Applications: Subway tunnels & stations, train tunnels, bus depots, road tunnels, underground parkings, mines, basement of warehouses, etc.
- SubWave makes GPS chipset work indoors:** Compatible with any PMR, P25, TETRA receivers  
No App or map download
- SubWave extends GPS coverage indoor:** SubWave computes specific adapted GPS signal for indoor  
Different from «GPS repeater» GPS receiver of user gets real «Latitude, Longitude, Altitude»
- Positioning resolution adaptable to operational objectives: discrimination between platforms (right or left), localization inside tunnel (> 5m or less...), floor discrimination (Altitude)

**Toulouse - New York - San Francisco**



**French Headquarters**  
5, chemin de Chèvrefeuille  
31300 Toulouse

[www.syntony-gnss.com](http://www.syntony-gnss.com)  
[contact@syntony-gnss.com](mailto:contact@syntony-gnss.com)

# Useful information

## Conference venue

The conference is held in the Convention center La Cité des Congrès. The address of the convention center :

**5, Valmy street (rue de Valmy)  
44000 Nantes**

It is located in the center of Nantes, on the banks of the canal Saint-Felix, within 7 min walk from the train station and 15 min walk from the city center.



## Registration Desk

The conference is held on the mezzanine on the 2<sup>nd</sup> floor of the Convention center

### OPENING HOURS:

Monday, 24 <sup>th</sup> of September	09:00 - 18:00
Tuesday, 25 <sup>th</sup> of September	08:15 - 18:00
Wednesday, 26 <sup>th</sup> of September	08:15 - 17:30
Thursday, 27 <sup>th</sup> of September	08:30 - 13:30

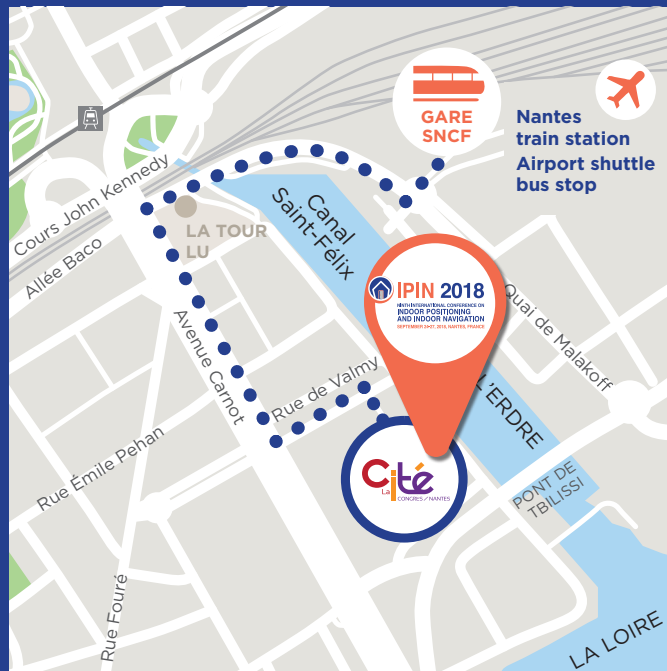

**7**  
**minutes**  
on foot from the  
Cité des Congrès  
to train station

## Presentations



### ORAL PRESENTATION

Each oral presentation will have 20 minutes including 4-5 minutes for questions. We recommend you to prepare your slides for a duration of about 15 minutes including an introduction. Each presentation room will be equipped with a video projector with a VGA connector and a Windows laptop with PowerPoint and Adobe Acrobat. We recommend you to embed all fonts and visuals in your presentations files. You should bring your presentation and a short biography on an USB drive and load your presentation into the conference laptop during the briefing session. Presentations are all synchronized during sessions. Please respect the time duration of your presentation.

### ATTENTION ! BRIEFING SESSION

According to the program of the conference, in the beginning of every day all concerned speakers (including alternates) should be present for the briefing session. It takes place in the **room I**. Please consult the program to know the exact time of your briefing session of the day.

During this session the speakers will meet the chairperson(s) of their respective session, confirm their presentation slot and load their presentation files into the conference laptop. In the absence of the confirmed appointed speaker during the briefing session, his/hers slot will be given to an alternate speaker who should also be present for a briefing.

### POSTER SESSION

For regular and Work in Progress papers accepted as a poster presentation, authors should prepare a poster of a size within A0 format. The posters will be hung in the **area R2** for the time of the conference. **The poster session takes place in the area R2 on Tuesday 25<sup>th</sup> of September between 15:30 and 16:30.** During the poster session authors should be ready to present their posters and to answer the questions of the attendees.

### LUNCHES, COFFEE BREAKS

Lunches (indicated in the program) will be provided free of charge for registered attendees at the **area R2**. Drinks and snacks will be served during the **coffee breaks** on the mezzanine floor from Monday 24<sup>th</sup> to Thursday 27<sup>th</sup> of September according to the conference program schedule. **Ice Breaker (welcome reception)** will be held on the mezzanine floor on Monday 24<sup>th</sup> of September at 18:00. No food is allowed in the conference rooms except Area R2 and the mezzanine during lunch time and coffee breaks.

### EXHIBITION

The exhibition will open to the attendees of the conference on Monday 24<sup>th</sup> of September at 17:40 on the mezzanine floor. It will be held simultaneously with the conference on Tuesday 25<sup>th</sup> and on Wednesday 26<sup>th</sup> of September from 10:00 until the end of the day. The representatives of the companies and the institutions in the indoor location from all over the world will present their latest innovations and solutions at the exhibition.



### Internet ACCESS

Free Internet access will be available during the conference

### Wi-Fi connection

Network name: IPIN2018  
Password: ipin2018





# Welcome to Cité des Congrès !



Find your way with this map

## 2. FLOOR

AUDITORIUM 450

ROOM I

ROOM GH

ROOM 200

MEZZANINE

AREA R2

## 4. FLOOR

ROOM KL

ROOMS M&N

SMOKING AREA

# EVENT MAP

Cité des Congrès  
Nantes, France



Ubiquitous geolocation technologies

Indoor location sharing in IoT context

Connected intelligent urban mobility

Special session

# Social event



## IceBreaker

We invite you to enjoy the performance of the Celtic music band Ghillie's and the Irish dance performers from Breizh Jiggers at the IceBreaker.



### THE BAND

Born in 2012, Ghillie's gathered four musicians passionate about traditional music. Their enthusiasm is galvanizing the dance repertoire, the French and Irish tunes. They are offering compositions with passion, creativity and virtuosity such as modern and original arrangements. Enthusiastically and with complicity, the band is communicating its good vibrations and musicality through a repertoire suitable for concerts but also for events.

#### Members of the Ghillie's band :

Philippe Carrillo (Celtic and electric harp)  
Éloïse Gomez (Violin)  
Éric Duverger (Percussions)  
Marine Bouzat (Flute, piccolo)

### THE DANCERS

When it was first imagined by Mathilde Rio in 2014, "Breizh Jiggers" aimed at bringing together local Irish dancers to create an Irish dance show very much in touch with its territory. The dancers all come from western France, and the influence of Breton rhythms and melodies permeates the pieces of choreographies they imagine to traditional jigs and reels. They naturally turned to the musicians of Ghillie's when looking for a band to collaborate with: dancers and musicians alike share a deep love for Irish culture while strongly valuing their French musical heritage. Don't miss the chance to discover this group of energetic and passionate dancers!



© Jean-Dominique Billaud

## Gala dinner

The Gala dinner will be held on **Wednesday 26<sup>th</sup> of September at 19:30**, at Les Machines de l'Île located at Parc des Chantiers, **Boulevard Léon Bureau**.

The registration for the Gala dinner (alone or accompanied with +1) is compulsory to attend the dinner. The registration is indicated on the backside of your badge, so please take your badge with you for the dinner. Be ready for the exquisite meal and the entertainment surprises of Les Machines de l'Île!



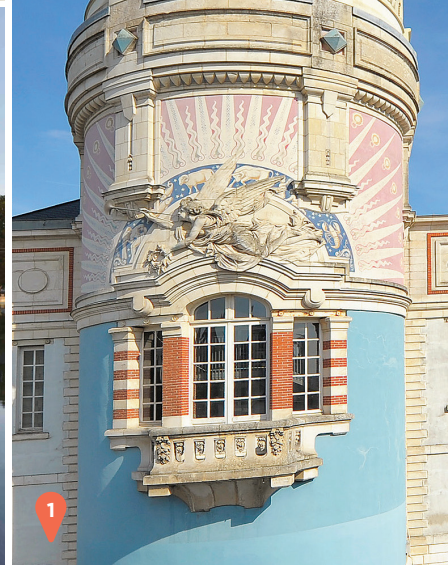



- 1 • La Tour Lu © V. Joncheray
- 2 • Le Château des Ducs de Bretagne © J.-D. Billaud
- 3 • Le jardin des plantes © M. Cortès
- 4 • La cathédrale Saint-Pierre et Saint-Paul © F. Toms
- 5 • Le théâtre Graslin © V. Joncheray
- 6 • Le Carroussel des Mondes marins  
Le grand Éléphant des Machines de l'île  
La grue Titan jaune © F. Toms
- 7 • Les Anneaux de Buren © B. Renoux

# Nantes

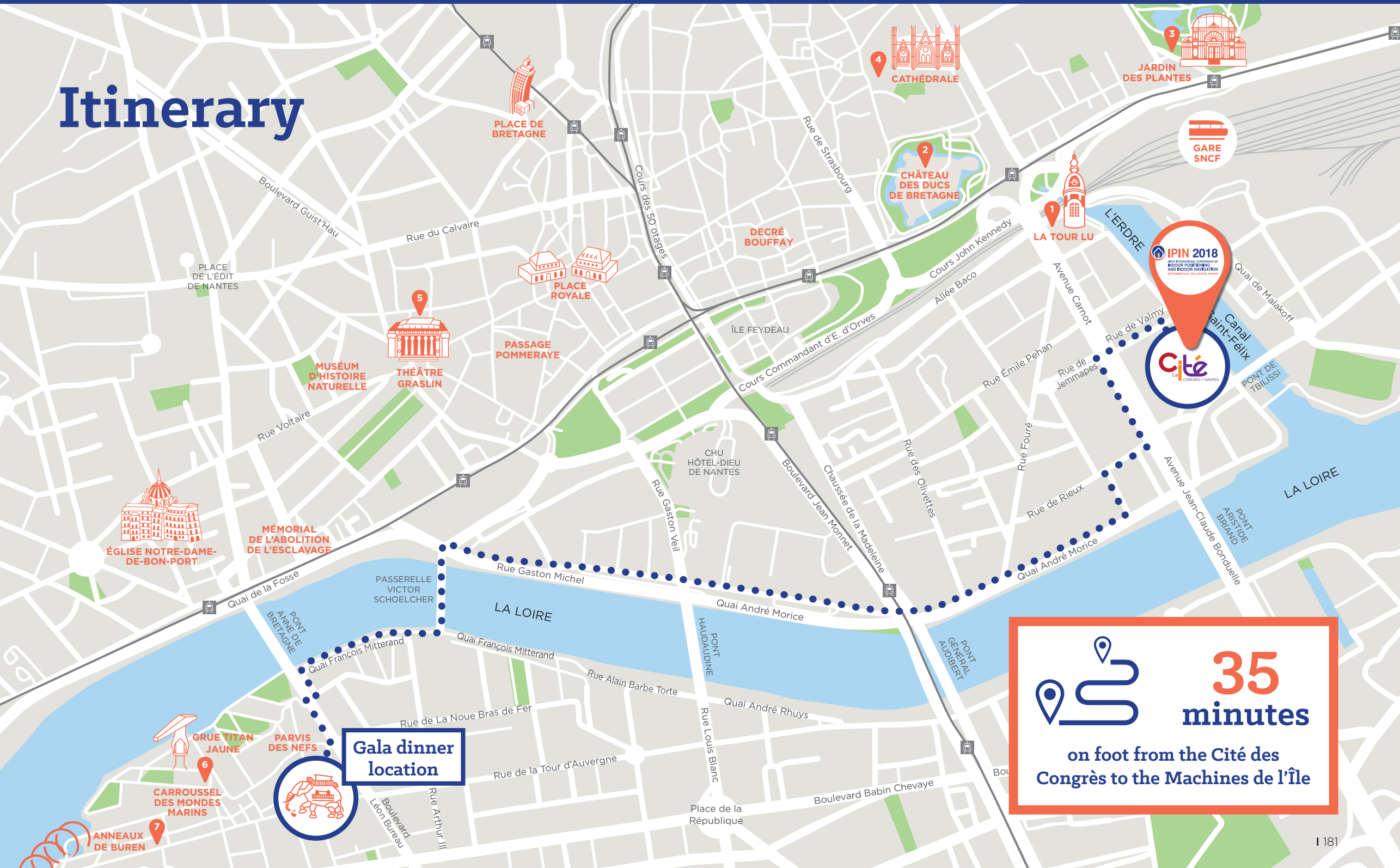

# Itinerary



 **35 minutes**  
on foot from the Cité des Congrès to the Machines de l'Île

**Gala dinner location**

# Acknowledgements

Dear participant,

Thank you for coming to IPIN2018!

We would like to acknowledge the contribution of numerous individuals and public and private institutions that helped us in organization of this conference.

We would like to thank La Cité des Congrès de Nantes and the shopping center Atlantis for providing us the facilities for the conference and its competition.

We express our gratitude to the sponsors of IPIN2018, especially Gold (SYSTNAV) and Silver sponsors (European GNSS Agency), as well as other sponsors (IRSTV, MDPI Journal Sensors), for their input in this event.

We thank the key players of the conference: our Technical Sponsors (IEEE, ITSS, IEEE Instrumentation and Measurement Society, Viametris) and our partners (ID4Car, Pays de la Loire region, la Ville de Nantes), along with our media partner (AFT and its journal XYZ).

We are very grateful to the members of Organizing Committees and the Competition Chairs for their hard work and the advice. Moreover, we want to recognize the remarkable work of the TPC members who have contributed their time to reviewing the papers submitted to the conference.

Eventually, we would like to say thank you to all our colleagues at IFSTTAR and our local partners who have put a lot of efforts in the organization of IPIN2018, shared with us their time and vision and created for you this outstanding event.

Finally, dear visitor, we wish to thank you for your participation and contribution to IPIN2018. We hope you enjoy your stay in Nantes.

Dr. Valérie Renaudin and Prof. Masanori Sugimoto  
Conference Co-Chairs

# Key players





# sysnav

NAVIGATION TECHNOLOGIES



*"Our teams of elite engineers from all horizons and Sysnav's disruptive savoir-faire enables us to pave the way to new solutions in inertial-magnetic technology."*

David Vissière - CEO

**23**  
patents

**10**  
years

**Bringing Ideas to Reality**