



**HAL**  
open science

## **CORDELEC A new mechanical analogy to learn electrocinetics**

Marc Ouellet, Coralie Leonard, Ludovic Morge

► **To cite this version:**

Marc Ouellet, Coralie Leonard, Ludovic Morge. CORDELEC A new mechanical analogy to learn electrocinetics. 19th Conference of the European Society for Cognitive Psychology (ESCOP), Sep 2015, Paphos, Cyprus. 2015. hal-01919320

**HAL Id: hal-01919320**

**<https://hal.science/hal-01919320>**

Submitted on 1 Mar 2023

**HAL** is a multi-disciplinary open access archive for the deposit and dissemination of scientific research documents, whether they are published or not. The documents may come from teaching and research institutions in France or abroad, or from public or private research centers.

L'archive ouverte pluridisciplinaire **HAL**, est destinée au dépôt et à la diffusion de documents scientifiques de niveau recherche, publiés ou non, émanant des établissements d'enseignement et de recherche français ou étrangers, des laboratoires publics ou privés.





# CORDELEC



## A new mechanical analogy to learn electrocinetics

Marc Ouellet<sup>abd</sup>, Coralie Leonard<sup>ab</sup>, Ludovic Morge<sup>c</sup>

<sup>a</sup>Clermont Université, Université Blaise Pascal, LAPSCO, BP 10448, F-63000 Clermont-Ferrand, France

<sup>b</sup>CNRS, UMR 6024, LAPSCO, 34 Avenue Carnot, F-63037 Clermont-Ferrand, France

<sup>c</sup>Laboratoire ACTÉ EA 4281, ESPE Clermont-Auvergne, Clermont Université, Université Blaise Pascal, France

<sup>d</sup>CIMCYC, University of Granada, Spain

19th Conference of the European Society for Cognitive Psychology (ESCP). 17 – 20 September, 2015 in Paphos, Cyprus

## Previous analogies to teach electricity

### Hydrolic analogies

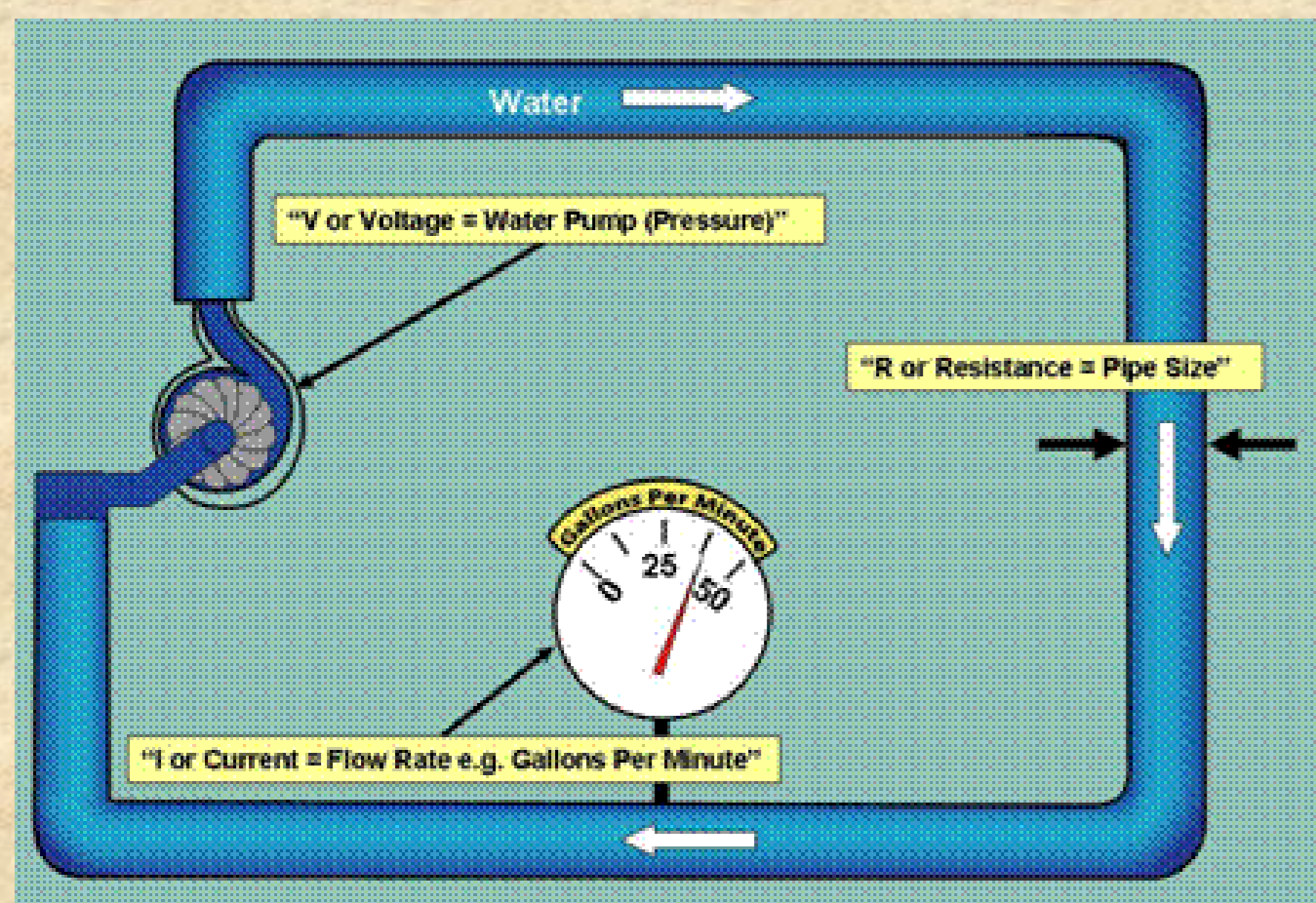

Wrong understanding of fluid pressure principles (Closset, 1992)

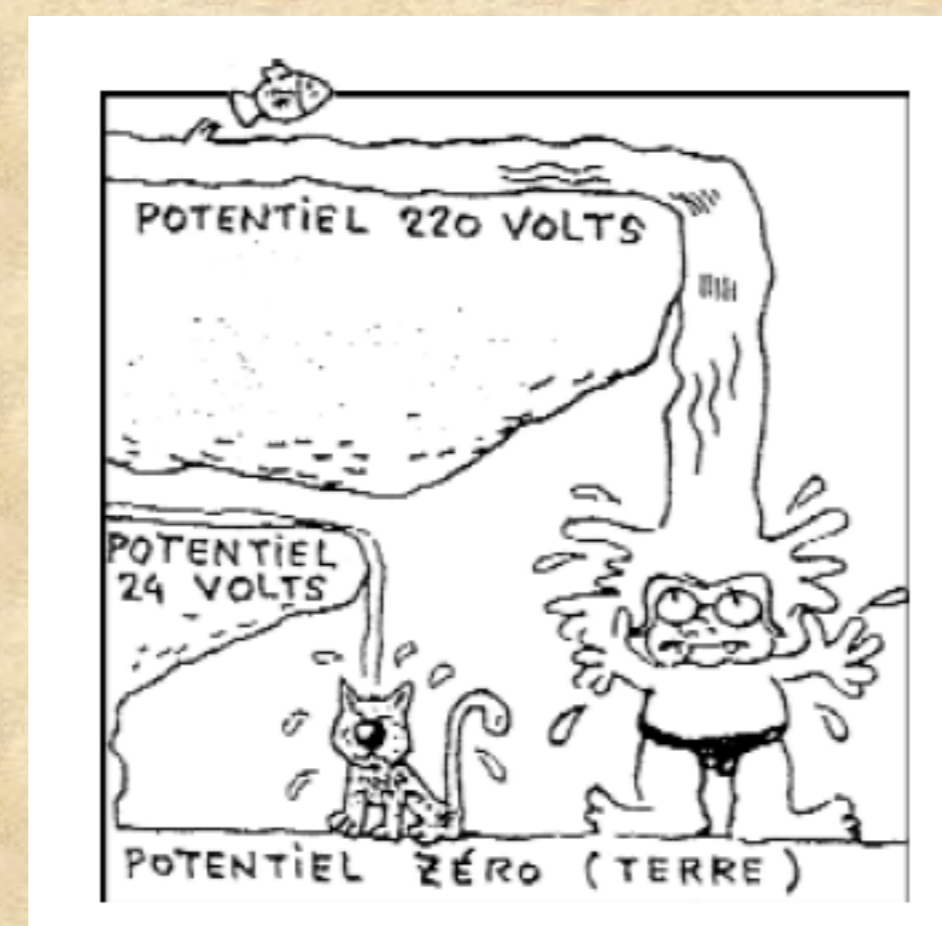

Constant amount of current even in the presence of a resistor

### Rail trucks analogy

(Joshua & Dupin, 1989)

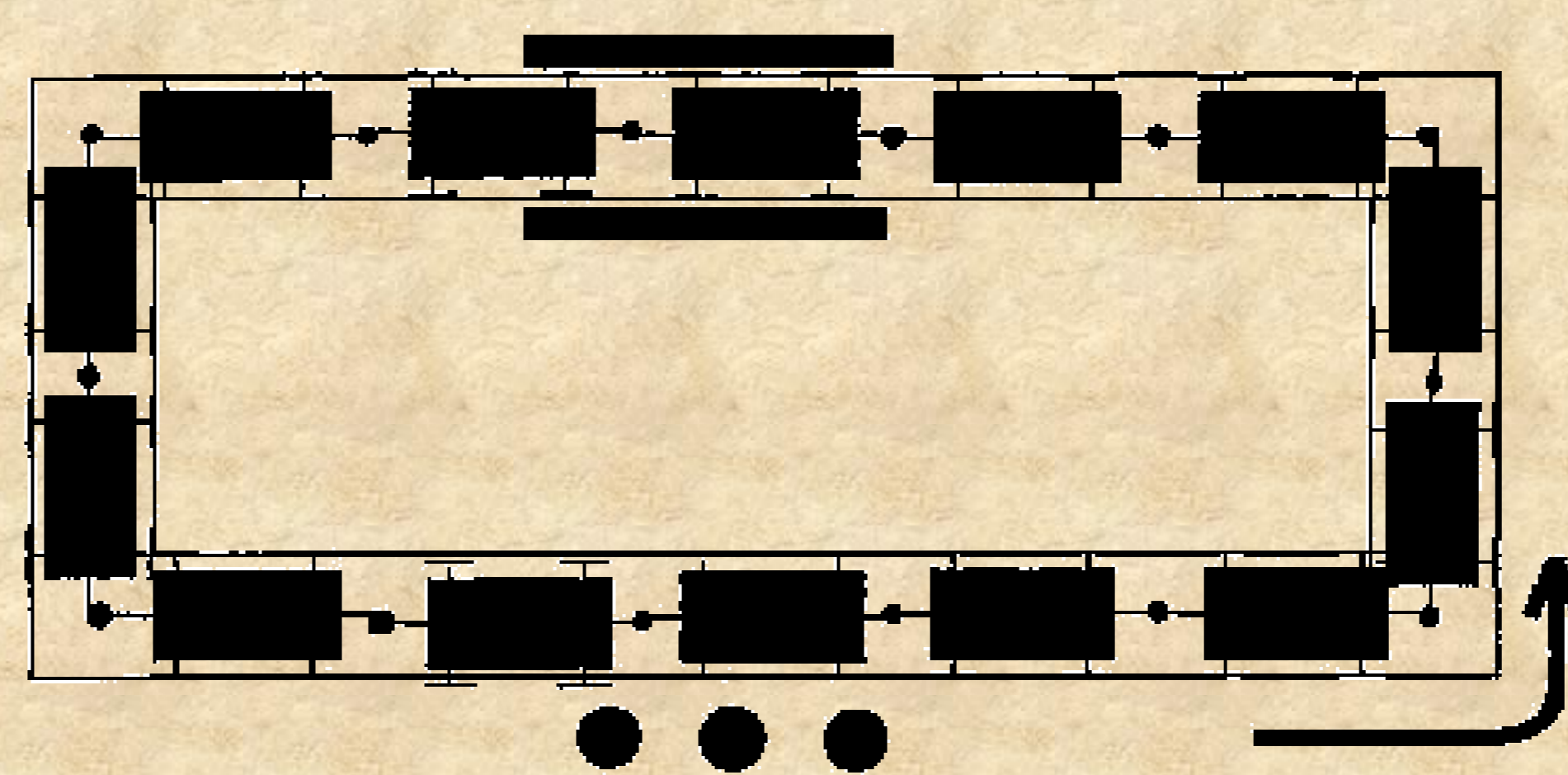

No difference between voltage and intensity

### Vans analogy

(Hind, Leach, Lewis & Scott, 2005)

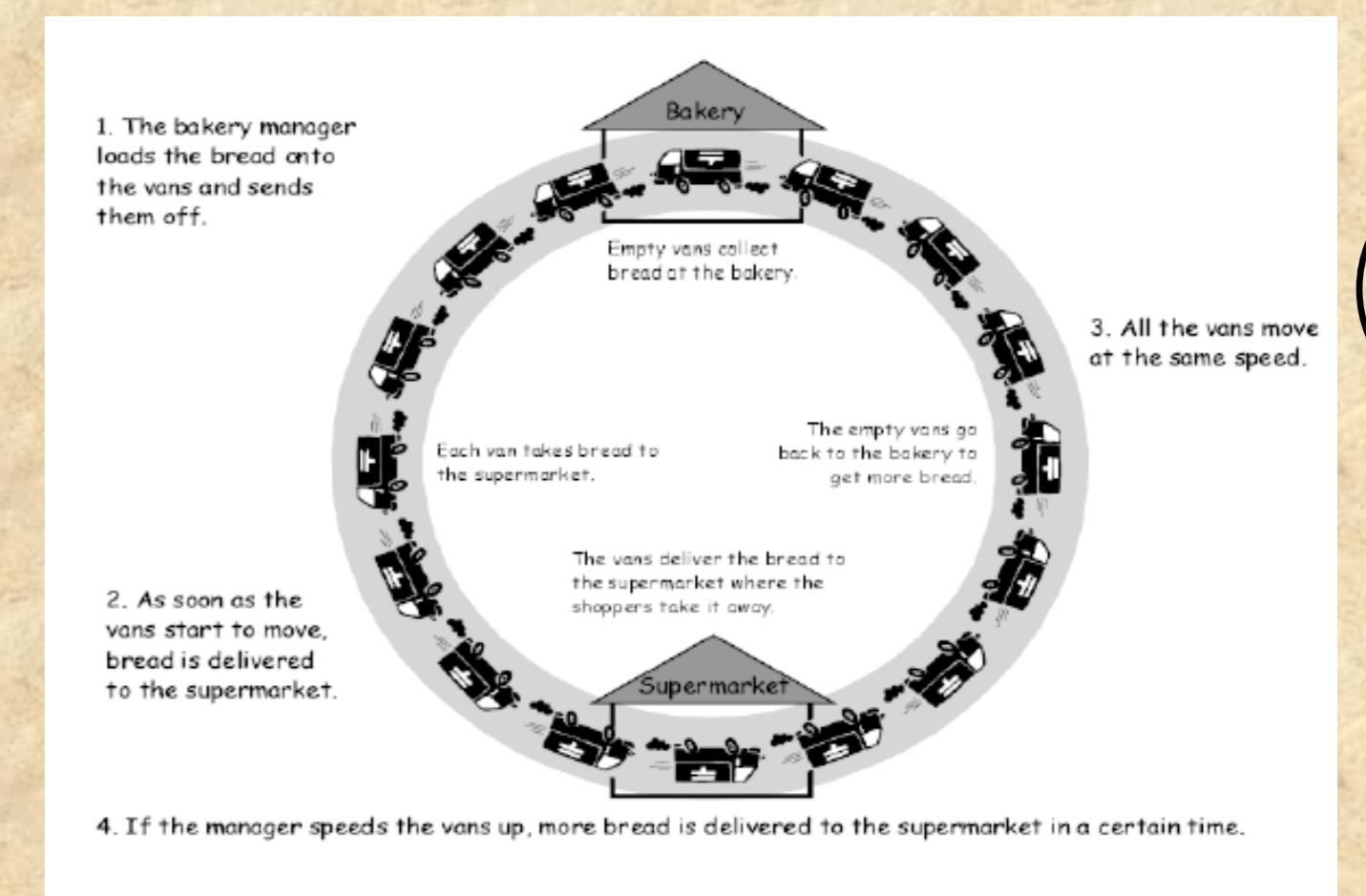

Substantialization of energy

## CORDELEC\* analogy

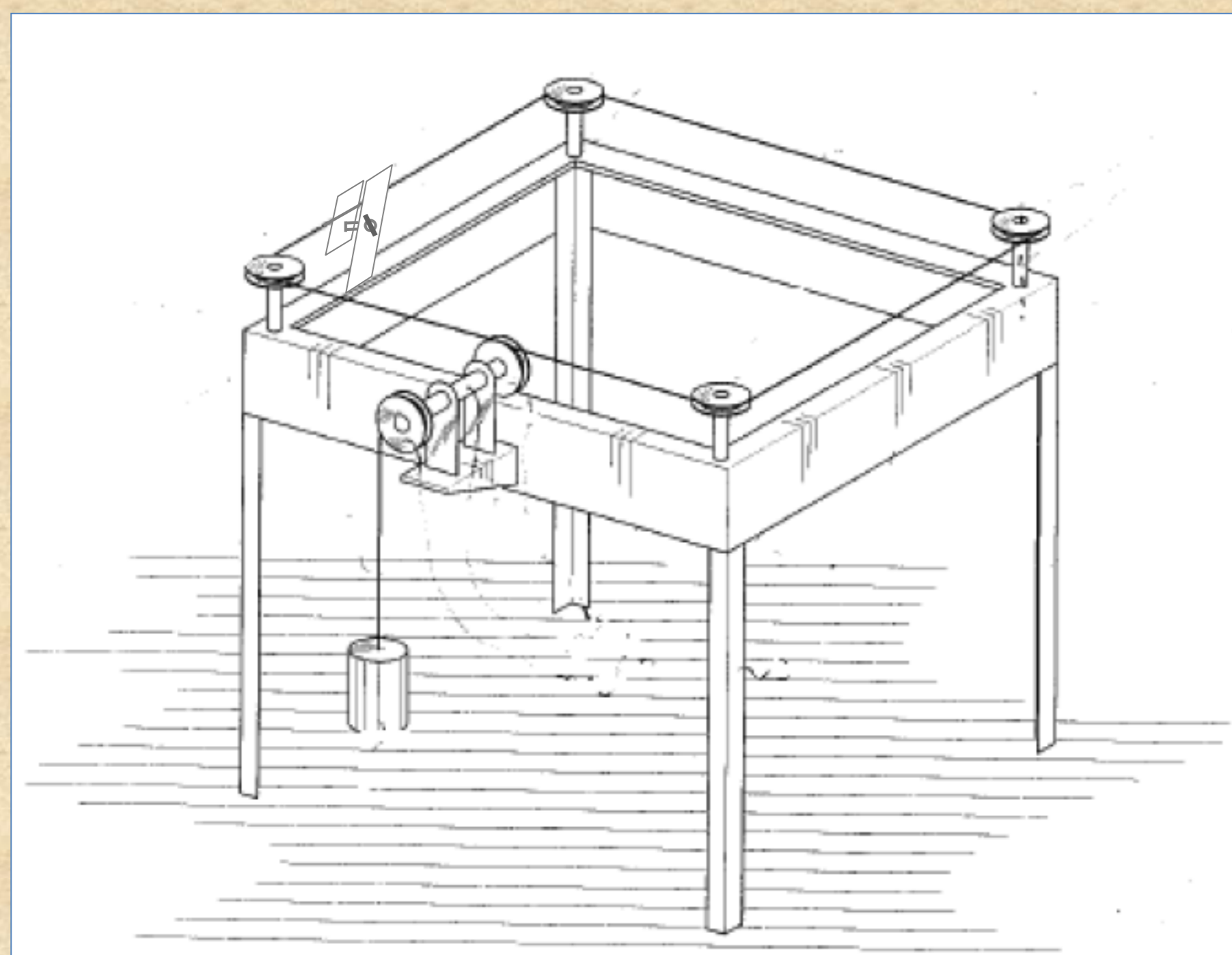

### Electricity

Voltage  
Intensity  
Energy of the generator  
Battery strength  
Resistor/Resistance  
Temperature increasing by Joules effect  
Switch

### CORDELEC

Difference in string tension  
Speed at which the string moves/goes round  
Energy of the mass of the mechanical generator  
Weight of the mass  
The string is pinched, causing friction  
Temperature increasing by mechanical rubbing  
Pliers

### Testing CORDELEC

2 groups: Gr. 1 trained with CORDELEC  
Gr. 2 trained without CORDELEC

Participants' knowledge on electrocinetics was tested just before (T1), just after (T2) and one week after (T3) the training.

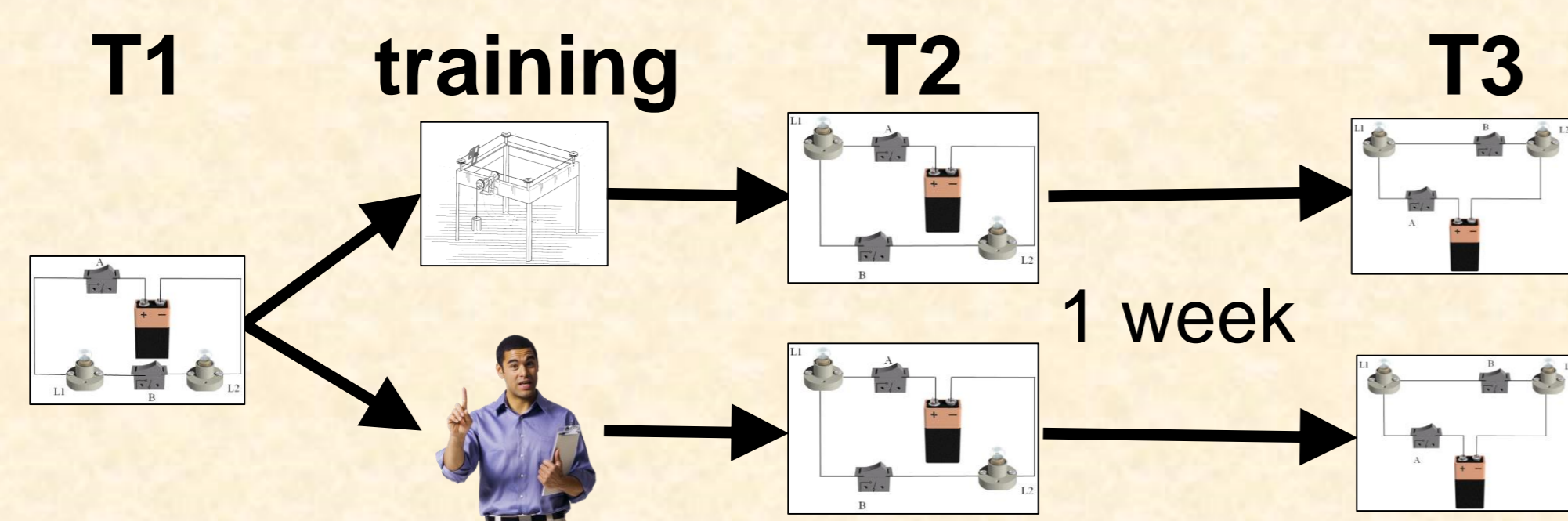

Example of one of the four possible questions:

If you turn on interrupters A and B, which of the following options is correct:

- 1. L2 and L1 will light up at the same time.
- 2. L2 will light up after L1.
- 3. L2 will not light up.

### Results

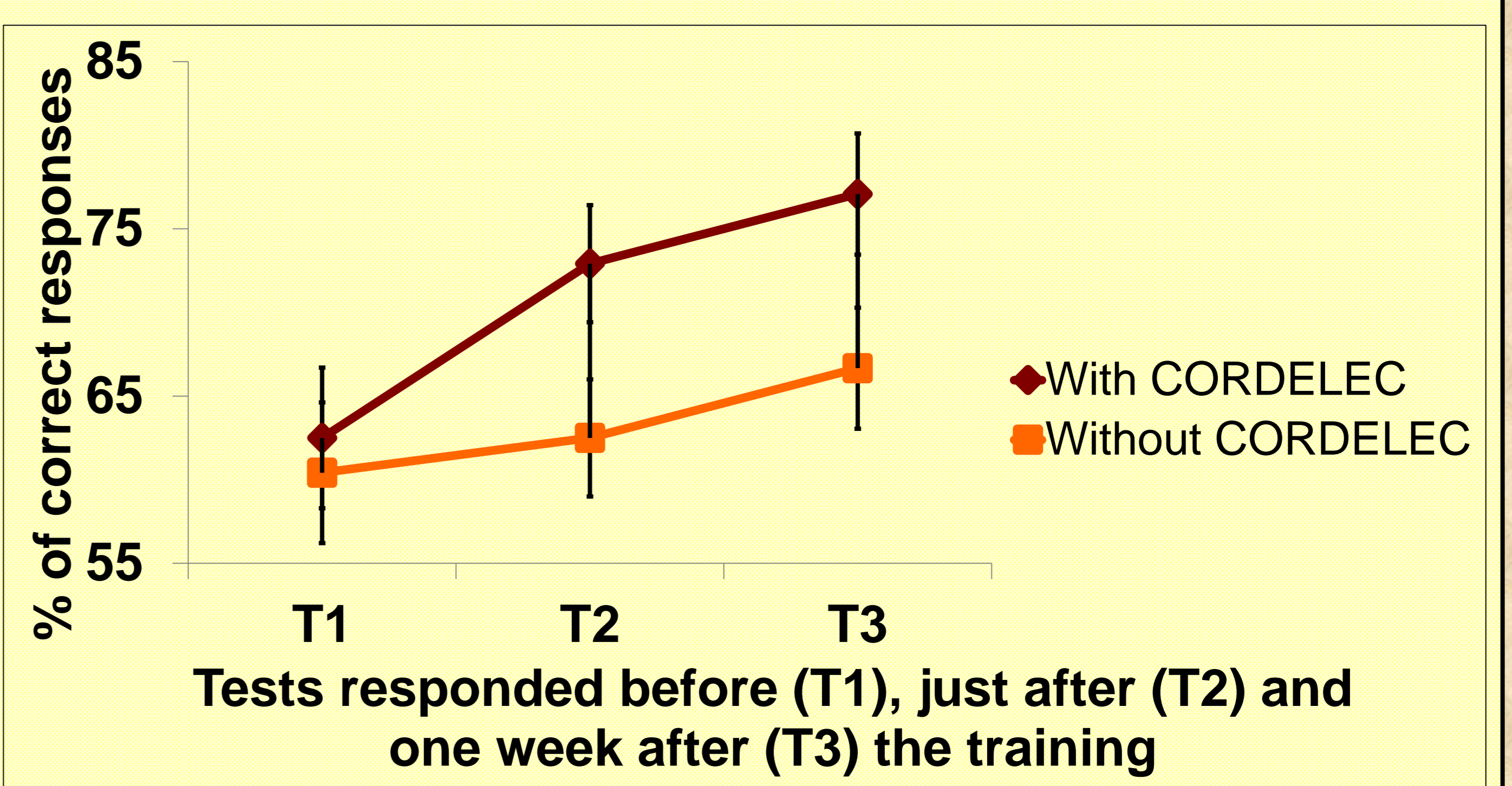

The answer to the previous example questions typically switched from "2. L2 will light up after L1" to "1. L2 and L1 will light up at the same time".

### Learning Impression

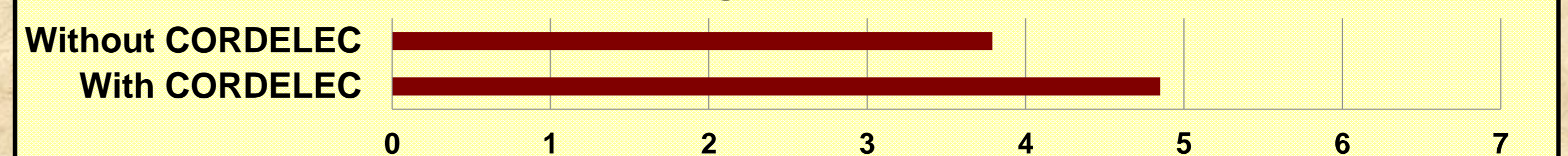

### Discussion

Participants showed a better learning when trained with compared to without the CORDELEC device.  
Participants also switched from a sequential to a systemic reasoning.  
CORDELEC might be a good analogy to teach electrocinetics in schools.

### References

- Closset, J.-L. (1992). Raisonnements en electricité et en hydrodynamique. *Aster*, 14(4), 143–155.
- Hind, A., Leach, J., Lewis, J., & Scott, P. (2002). A teaching scheme delopped from research evidence on student's learning about electric circuits. Retrieved October 30, 2012, from [www.education.leeds.ac.uk/research/cssme/ElecCircuitsScheme.pdf](http://www.education.leeds.ac.uk/research/cssme/ElecCircuitsScheme.pdf)
- Joshua, S. & Dupin, J.-J. (1989). *Représentations et modélisations: le "débat scientifique" dans la classe de l'apprentissage de la physique*. Berne: Peter Lang.

\*technology available for licensing