



HAL
open science

Shape differences in the pelvis of the rabbit, *Oryctolagus cuniculus* (L.), and their genetic associations

John P N Watson, Simon J M Davis

► To cite this version:

John P N Watson, Simon J M Davis. Shape differences in the pelvis of the rabbit, *Oryctolagus cuniculus* (L.), and their genetic associations. 2019. hal-01918838v2

HAL Id: hal-01918838

<https://hal.science/hal-01918838v2>

Preprint submitted on 21 Mar 2019

HAL is a multi-disciplinary open access archive for the deposit and dissemination of scientific research documents, whether they are published or not. The documents may come from teaching and research institutions in France or abroad, or from public or private research centers.

L'archive ouverte pluridisciplinaire **HAL**, est destinée au dépôt et à la diffusion de documents scientifiques de niveau recherche, publiés ou non, émanant des établissements d'enseignement et de recherche français ou étrangers, des laboratoires publics ou privés.

Shape differences in the pelvis of the rabbit, *Oryctolagus cuniculus* (L.), and their genetic associations

J.P.N. Watson¹

S.J.M. Davis²

¹Chercheur associé, ASM - Archéologie des Sociétés Méditerranéennes, UMR 5140, Université Paul-Valéry, CNRS, MCC, F-34000, Montpellier, France. Labex ARCHIMEDE programme IA- ANR-11-LABX-0032-01.

²Laboratório de Arqueociências (LARC), Direcção Geral do Património Cultural, Calçada do Mirante à Ajuda 10A, 1300-418 Lisbon, Portugal; e-mail: simonjmdavis@gmail.com

Abstract

Six measurements were taken on the pelvis of modern and archaeological rabbits from France and the Iberian Peninsula and a difference in shape was noticed between the French and Iberian populations. A discriminant function was calculated using the geographically most extreme samples and it appeared that the shape difference was confined to samples from the mitochondrial DNA (mtDNA) lineage B. Since many of the modern rabbits had been previously analysed genetically, it was possible to relate the pelvis morphology to the mtDNA type, and it was found that there was an association between the two. A re-evaluation of the phylogeny using all available mtDNA control region sequences suggests that the main groups of haplotypes all branched off at much the same point, presumably as a result of the end of the ice age and the consequent expansion of rabbit populations both within the Peninsula and out of the Peninsula into France. Two groups (B9 and B10) are exclusive to the Peninsula and one (B4) is virtually exclusive to France. Another group (B1) is associated with domestic rabbits. Finally, two subgroups of the mtDNA type B3 are now seen to be distinct groups, one of them (B3A) being associated with domestic rabbits while the other (B3C) is only found in French wild rabbits. Previous work in which B3 rabbits were treated as a single entity therefore needs to be re-evaluated. Whether the association between pelvis shape and mtDNA type stands up to further investigation or not, their study in archaeological material could help to elucidate the pattern of dispersal of rabbits after the ice age and the process of their domestication.

Introduction

When the junior author (SJMD) announced that he was going to take measurements on the long-bones of a large number of rabbits from different parts of western Europe with the aim of documenting in detail the relationship between winter temperatures and body size first pointed out by Bergmann (1847) (Davis, in prep.), the senior author (JPNW) persuaded him to take at the same time a series of six measurements on the innominate bone of the pelvis, or coxal bone (*os coxae*), in the hope of being able to discriminate between the sexes. In the pelvis of rabbits, in contrast to other species of mammals, there are no obvious morphological differences between the sexes because the young are so small when born.

The analysis of the difference between the sexes was disconcertingly inconclusive, but on the other hand, to our great surprise, there was a marked difference between rabbits from different geographical areas. Three large samples from France, two from the north and one from the south, stood out as being different from those from the Iberian Peninsula.

Materials and Methods

The modern rabbit specimens studied come from the collections of the "Muséum national d'Histoire naturelle" in Paris (MNHN) and belong to the same animals from France and the Iberian Peninsula on which the initial genetic analyses on mitochondrial DNA (mtDNA) were carried out (Biju-Duval et al., 1991; Hardy et al., 1994; Monnerot et al., 1994; Mougél, 1997; Callou, 2003). The material from the Tunisian island of Zembra was also measured, even though Zembra is not of direct relevance to the issues considered here. A metrical analysis of many of these animals, especially their skulls, has already been made by Callou (2003).

The specimens are listed in Appendix 2 and both the number in the MNHN register and the number allocated by Callou are given, together with the values of the measurements taken and any information about the sex and age of the animal. Only part of the material had been determined to sex.

For the present analysis only the localities with more than 10 adult specimens have been used, although specimens from many other localities from which only a few rabbits had been obtained were also measured. Exceptions to this are those adult specimens from small samples from France or Navarre for which genetic information was available. The main samples used are thus those from Roissy, Versailles, Tour du Valat, Peralta, Tudela, Las Lomas, Badajoz, Vila Viçosa and Santarém. The smaller samples from Navarre, those from Arróniz, Caparros, Castejón, Falces, Miranda de Arga, Ribaforada and Sesma, are all from the south, not far from Peralta and Tudela.

Since the rabbits were wild, precise ages were not available. However, the relative ages of the innominate bones could be estimated from the state of fusion of the other bones of each individual, in particular the proximal humerus, proximal tibia and calcaneum. In the main analyses only specimens in which the proximal humerus was fully fused were included, since that is usually the last of the three epiphyses mentioned to fuse.

In addition, material from three archaeological sites was studied. The six measurements used had been devised during the study of the Magdalenian site of Cova Matutano (Watson, 1999; Olària,

1999) and so the better preserved specimens from that site were included for comparison; in some layers many bones were burnt to a greater or lesser degree and so any bone that was discoloured in a way that might have been due to burning was excluded from the study. Material from two sites in southern Portugal studied by SJMD was also measured: Silves dates from the 12th-13th century AD and Beja from the 15th century AD (Davis et al., 2008; Martins et al., 2010).

The measurements taken are described in detail in Appendix 1 (see also Figures 1 and 2). Two measurements were taken on the shaft of the ischium (H and I) and three on the shaft of the ilium (E, F and F1). The remaining measurement (J) is between the rim of the acetabulum and the lateral border of the ischium. These are not measurements that have generally been taken previously, with the exception of E, which appears in practice to be equivalent to the KB (or SB) of von den Driesch, and possibly F, which may or may not be equivalent in practice to her KH (or SH) (von den Driesch, 1976a; von den Driesch, 1976b). They were chosen for their unambiguous definitions and the precision with which they can be taken, together with their relatively low susceptibility to damage in archaeological material; as long as the ilium and ischium are not broken apart at the acetabulum and the bone is not heavily gnawed the measurements can usually all still be taken.

In the modern samples only the left innominate bone was measured. In the archaeological samples both left and right bones were measured.

Analysis and Results

A preliminary investigation plotting the various measurements against each other showed no obvious sexual dimorphism. On the other hand, the three French samples (Roissy, Versailles and Tour du Valat) showed a certain separation from the Iberian samples when F1 or I was plotted against H (Figure 3).

To extract the maximum information from the measurements a multivariate analysis was then carried out in two stages, using only the specimens from individuals in which the humerus was fully fused. First of all, the principal components for the 6 measurements were calculated. The first principal component was then treated as representing the variation in size. The other 5 principal components can then be regarded as essentially independent of size, so that any variation in them is variation in shape (Jolicoeur & Mosimann, 1960). This procedure has been criticised for not taking into account allometric changes (Sundberg, 1989), and many recent studies have allowed for allometry (e.g. Callou, 2003), but for the kind of exploratory analysis with small samples attempted here allometry is irrelevant, especially since the study is based on the adult specimens from a single species. In the field of zooarchaeology, size and shape components have previously been distinguished by Kuşatman (1991), Davis (1996, 605) and Burke et al. (2003, 462).

To bring out the shape-difference between the French and Iberian rabbits we therefore calculated a linear discriminant function based on the 2nd to 6th principal components, using the Roissy and Versailles samples as one group and the Las Lomas sample as the other group, since they were the geographically most extreme samples. The first principal component was then plotted against the discriminant score to give a graph in which the vertical axis represents size and the horizontal axis represents the shape-difference (Figure 4). The discriminant score in terms of the original variables was $-31.65 F1 + 9.14 F - 3.81 E - 1.94 J + 35.86 H - 33.57 I + 96.583$ and the first principal component was $0.925 F1 + 0.903 F + 1.015 E + 0.861 J + 0.849 H + 1.180 I - 32.482$.

Although the two groups are almost completely separated, the separation is based mainly on size. Nevertheless, there is a considerable difference in mean discriminant score between the two groups. The coefficients resulting from the calculations were then applied to other samples to see how they fitted in.

The difference between males and females for Roissy alone is shown in Figure 5, Roissy being the sample that shows the clearest sexual dimorphism. It can be seen that although there is a size difference, the males tending to be larger than the females, there is little difference in shape. Figure 6 shows the mean size plotted against the mean discriminant score for the males and females at each site and it can be seen that the other sites do not follow the Roissy pattern. Not only are the mean sizes for the females slightly larger than those for the males at some sites, but also the shape differs in one way at some sites and in the opposite way at other sites, as measured by the discriminant score.

To investigate the influence of age, the specimens for which the corresponding proximal humerus was fully fused were compared with those for which it was unfused or incompletely fused. The proximal humerus was generally the last epiphysis to fuse in the bones that were studied, since the femur was excluded. Only one animal, which came from Badajoz, had a proximal tibia with the fusion plane still visible after the proximal humerus had become fully fused. Figure 7 shows the results of the comparison for the individual specimens from Roissy. It can be seen that in general there is some difference in size but not a great difference in shape. Figure 8 shows the mean size plotted against the mean discriminant score for the specimens with fully fused and incompletely fused humeri from each site. Once again it can be seen that the direction of the difference in shape varies from site to site but that the difference is not large. Only sites where there were a considerable number of young animals have been shown in Figure 8, so that several bones have been left out although they are included in the lists in Appendix 2 for the sake of completeness.

Figure 9 shows, for all the main sites, the mean size plotted against the mean discriminant score for the specimens for which the corresponding proximal humerus was fully fused. The way in which the points are distributed suggests that the differences in discriminant score cannot be accounted for entirely by sex or age differences, particularly since age should not be an important influence in Figure 9, given that further change with age once the humerus is fully fused must be rather limited. There is a general trend from south-west Iberian sites on the left to French sites on the right, but two sites stand out. One is Tour du Valat, which has an even higher score than Roissy or Versailles in spite of being in a less extreme position geographically. The other is Tudela, which in spite of being geographically very close to Peralta is even more "Iberian" than Las Lomas.

Figure 10 shows the individual scores for Tour du Valat and Las Lomas, the two southernmost sites in France and the Iberian Peninsula respectively, with bones of comparable size. It shows that although there is still a good deal of overlap the general difference in shape is quite marked.

At this point the specimens from the three lowest faunal phases at Cova Matutano were added to Figure 9, in the expectation that they might fall somewhere above the Peralta or Tudela samples. In fact they fall even further to the left than Tudela (Figure 11).

It was therefore decided to calculate a new discriminant function using Roissy and the earliest phase at Matutano as the groups to be discriminated, especially since the sizes of the bones from the two sites were similar. For good measure, the two other archaeological sites, Beja and Silves, were also

added to the data used in the calculation of the principal components. The new discriminant score was $-91.57 F1 + 24.62 F + 73.93 E - 46.01 J + 90.33 H - 59.91 I + 223.993$ and the first principal component in terms of the raw measurements was $0.755 F1 + 0.885 F + 1.025 E + 0.799 J + 0.868 H + 1.173 I - 30.956$.

Figure 12 shows the result when the samples used in Figure 11 are plotted using the new discriminant scores. The improvement in the separation between the French and Iberian sites is surprising, and Tour du Valat is now more aligned with Roissy and Versailles than before. On the other hand Tudela is even further to the left and away from Peralta. However, on reflection it occurs that there may be a good reason for these differences. The initial discriminant function was based on the comparison of one sample of rabbits belonging to mtDNA lineage A (Las Lomas) with two samples belonging to mtDNA lineage B (Roissy and Versailles). The new discriminant function is based on Roissy, belonging to lineage B, and Matutano, a sample that from its geographical location might be presumed to also belong to lineage B.

The present-day transition zone between lineage B and lineage A lies well to the SW of Matutano (Figure 13) and any movement of the zone since the end of the last glaciation might be expected to be towards the north rather than the south. Further analyses have discovered many other genetic differences between the rabbits on either side of the transition zone and have shown that lineage A corresponds to the subspecies *Oryctolagus cuniculus algirus* and lineage B to the subspecies *Oryctolagus cuniculus cuniculus*. Although there is strong gene flow and hybridisation within the zone there are also strong genetic barriers to reproduction that mean that the zone must have existed for a long time and that a process of speciation has begun (Carneiro et al., 2013; Carneiro et al., 2014).

Figure 14 shows the individual specimens from Roissy and Matutano at the same scale as in Figure 12. There is some overlap, but not a great deal. Figure 15 compares the individual specimens from Peralta and Tudela. The Tudela samples are widely scattered and so might represent a mixture of two types, one like Peralta and another with a more “Iberian” shape.

Figure 16 is the same as Figure 12 but with with Beja, Silves and Zembra added. The samples from Beja and Silves, which presumably belong to lineage A, fit in well with the modern members of that group. The sample from Zembra also fits in well, but is known to belong to lineage B. However, when considered as merely rather small members of lineage B, their position below Peralta fits in well with the origin postulated for the animals with which the island of Zembra was originally populated. They seem most likely to come from somewhere on the east coast of the Iberian Peninsula where their mtDNA type B6 is also found at the present day (Branco et al., 2000, Table 2). Analyses on archaeological material implied that the modern rabbits from Zembra were descendants of those there 1400 years ago (Hardy et al., 1995), with no sign of any subsequent introduction of new stock.

Finally, Figure 17 shows the effect of adding a few specimens of two breeds of domestic rabbits from the MNHN collection. Since they are so large compared with the wild rabbits, the vertical scale has had to be compressed so that they would fit, but otherwise the rest of the figure is identical to Figure 12, except that the range shown on the horizontal axis has been reduced, so that the mean discriminant scores appear more spread out than in Figure 12. What is interesting is that the domestic rabbits fall on the right of the graph, above Roissy and Versailles. This fits perfectly with the postulated French origin for all breeds of domestic rabbit, which mainly show the mtDNA type

B1 that is common in northern French wild rabbit populations, which derive from from the Mediaeval expansion of the range of the species when the keeping of rabbits in warrens became popular (Queney et al., 2002; Hardy et al., 1995).

Genetic Associations

The reasons for the difference in shape would appear to be genetic. Other possible explanations seem unlikely; it is clearly not related to temperature or other climatic factors and there is no obvious relationship to other features of the environment, such as the terrain.

As far as the results of the discriminant analysis are concerned, it seems that the large differences in shape that have been found affect only lineage B, that is to say only the subspecies *Oryctolagus cuniculus cuniculus*. Although shape differentiates lineage A from some of the lineage B samples, the variation in shape is essentially a phenomenon confined to lineage B.

The lineage A samples are remarkably similar to each other in spite of the differences in their chronological and geographical origins and are in fact clustered more closely together in the new analysis than in the original one. On this basis, the Beja and Silves samples, in spite of their date, are likely to be just local wild rabbits belonging to lineage A and not domesticated animals belonging to lineage B, with the possible exception of one specimen from Beja.

Given that lineage A and lineage B have been separate for such a long time, it is not surprising that there should be differences that affect one subspecies but not the other. What is surprising is the lack of correlation between obvious physical differences and major genetic differences. The two subspecies are so similar morphologically that it was only recently that the identity between the subspecies and the genetic lineages was firmly established (Geraldès et al., 2006). Size had long been used as a criterion, but it turned out that some of the smallest rabbits, those from Zembra, were from lineage B (Hardy et al., 1994; Callou, 2003, 23) Now it seems that in the same way a morphological difference in the pelvis has nothing to do with the difference between subspecies.

There is no reason, of course, to suppose that it is differences in the mtDNA itself that are responsible for the differences in shape, but at present there is very little other genetic information that can be related to them. Other kinds of genetic material have been studied and the types that were found have been related to their geographical origins, but although in some cases samples were from the same localities as the animals studied here, no direct link can be made between pelvis shape and genetic type. A link can only be made indirectly by association with the same geographical area, but even when two samples come from the same locality their composition may differ. In general the material studied has not been sufficient to show clear differences except between the A and B zones (Geraldès et al., 2006; Geraldès et al., 2008; Carneiro et al., 2010; Carneiro et al., 2014). The modern rabbit material from the MNHN was collected as part of a project that studied the variation both in the mtDNA and in microsatellites (Queney et al., 2001). Although the microsatellite results show differences between broad regions, such as south-western and south-eastern France, there is for example no difference between Tudela and Peralta in their microsatellite alleles.

The disadvantage of mtDNA is that since it is essentially transmitted only through the maternal line it may not be at all representative of the population to which an animal belongs and may have little

relation to the rest of its genetic makeup and thus to the factors affecting pelvis shape, supposing that they are not determined by the mtDNA.

In spite of this, the mtDNA is still likely to be the most informative subject for analysis. The first reason is that in rabbits, as in many species, the females tend to move around less than the males, so that on the whole the mtDNA is likely to be representative of the population in which it is found. The second reason is that in this particular case the limitations imposed by the climate and thus by the barriers created by mountain ranges, especially the Pyrenees, are important in determining the pattern of expansion of rabbit populations during the last stages of the glaciation. Under natural conditions the area of distribution of the rabbit seems to be limited by the need for the mean January temperature to be above 1 to 2 degrees Centigrade. The females are likely to remain within this zone. The males may well wander further afield in warmer months and thereby cross a mountain range, but if they then breed with females from another population their mtDNA will not be transmitted. This means that the Pyrenees are an effective barrier to the spread of mtDNA at the present day except at the western and eastern ends.

In rabbits it is the young females for whom there is no room at the parental warren that move away to found new colonies (Lockley, 1965, 134-135). The mtDNA is thus the best indicator of the pattern of evolution and spread of rabbit populations in the short term, although in the longer term older-established populations that suffer a setback, for example as a result of a colder climate, will tend to be replaced by populations with more recently evolved mtDNA types and the previous pattern will become obscured.

Through the kindness of Florence Mougél in giving us data from her thesis (Mougél, 1997) and from an unpublished paper (Mougél et al., unpublished; Mougél, pers. comm.), we have been able to relate many of the specimens measured to their mtDNA types.

In the initial studies of mtDNA polymorphism in rabbits (Biju-Duval et al., 1991; Monnerot et al., 1994), three specimens from Versailles were classified as being of type B1, as were the two specimens from Donzère and three of the specimens from Arzujanx. Unfortunately only one of the measured specimens from Versailles can be related to its type, which is indeed B1, but on the other hand the Roissy specimens can be identified to type and it is not surprising to find that most of them are of type B1. One adult specimen from Roissy belongs to type B3 and two more are either B3 or B4. The young specimens from Roissy are also all B1 or B3-B4. The remaining specimens from Arzujanx belong to type B3.

The Tour du Valat sample was established by Monnerot et al. (1994) as being all of type B4, except for one that was B5, and it is now clear that all the measured specimens are B4. The French rabbits would thus all be B1, B3 or B4 and the "French" morphology would seem to be associated with these types.

However, in Navarre three other types were found by Biju-Duval et al. (1991), coming from Sesma, Arróniz and Tudela. Monnerot et al. (1994) subsequently named them B8, B9 and B10 respectively, also adding a new type, B11, that they identified from Castejón. The "Iberian" morphology might therefore be expected to be associated with these types. The problem was that 24 specimens from Tudela had been measured but only 14 had been typed by Monnerot et al. (1994), to types B9 and B10, while no information was available about the types present in the other large sample from Navarre, the one from Peralta.

Thus the marked difference in average shape between the specimens from Tudela and Peralta (Figure 15) could not easily be explained. A subsequent study by Branco et al. (2000) of different material from Tudela and Peralta gave a rather different pattern of types. Types B8, B9 and B10 could not be distinguished from each other but accounted for only about half the types from Peralta and three-quarters of the ones from Tudela, the remaining types including B1, B3 and B4 as well as some new ones.

Fortunately, Mougél's data provide the answer. All the more extreme Tudela specimens are of type B10 (Figure 18), while B10 is absent from Peralta and the other samples measured from Navarre, which are mainly of types B9 and B3.

Examination of the scatter of points for the adult specimens for which the mtDNA type has been determined shows that there is no noticeable shape difference between the B1 and B4 rabbit pelvises. Nor is there any noticeable difference between B3 and B9. Thus there are essentially three groups, B1 and B4 on the right, B3 and B9 in the centre and B10 on the left; B6, represented by the sample from Zembra, can be added to the central group (Figures 19 & 20). Unfortunately, B11 was not found in any of the specimens measured. For what it is worth, the single B8 specimen measured, the type-specimen from Sesma, falls quite far to the left, nearer to the centre of the B10 cluster than to that of any other (Figure 20). Figure 20 shows that there is not a great deal of overlap between B1 and B4 on the right and B10 on the left. (The extreme outlier from Roissy shown in Figures 4, 5, 7 and 14 does not appear since it was not identified to type and so may not be B1, or even B3 or B4.)

The differences in discriminant score between the various types were tested with the Mann-Whitney test (two-tailed). The difference between B10 and all the other types was significant at the 98% level or more. With the exception of B3, each member of the central group was found to be different from each member of the group on the right at a significance level of 95% or more. Type B3 was probably not distinguishable from the members of the group on the right because the sample was so small. Table 1 shows the probability levels for the differences between the various types.

The original types defined by Monnerot et al. (1994) were based on RFLP (restriction fragment length polymorphism) analysis of the complete mtDNA genome. That is to say, restriction enzymes that cut DNA in specific places are used to find differences between the DNA sequences of two individuals. The differences are manifested as differences in the lengths of the DNA fragments produced. Monnerot et al. (1994) tested for differences at 110 sites along the length of the genome, but only 17 of these showed variation within the B-lineage and so provided the basis for the B mtDNA types.

However, Mougél (1997) made a more detailed analysis and defined types on the basis of sequencing part of the control region of the mtDNA and so being able to compare every nucleotide site in all the individuals studied. Thus the possible number of differences was much higher and is reflected in the large number of types identified. Within the B-lineage there were four times as many sites that varied as there were in the RFLP analysis by Monnerot et al. (1994). At the same time, many of these control region types could be related to the types defined previously since the same individuals had been studied. Thus, for example, the sequence found in those specimens classified by RFLP as B9 was called B9zsa and the three different sequences found in the specimens classified as B3 were called B3Zsa, B3Zsb and B3Zsc respectively. The ten control region types that could not be related to an established RFLP type were given numbers prefixed with "Bzs" and were thus called Bzs1 to Bzs10.

In Mougel's thesis, a "z" was used to indicate a sequence with a length of around 200 nucleotides and a "Z" to indicate one with a length of around 400. Most of the specimens were subsequently re-sequenced and lengths of more than 300 obtained, so that the difference is no longer relevant. In general a "z" has since been used for sequences of all lengths, both in publications (Branco et al., 2002; Letty et al., 2007) and in the NCBI database (<http://www.ncbi.nlm.nih.gov>), but some types in the NCBI database are still written with a "Z". In the present paper "z" will be used throughout from now on.

When a longer sequence was obtained as a result of resequencing a specimen, in some cases further differences were then found, so that the specimen had to be reclassified; for example, specimen RI5 (or Ri05) from Ribaforada was originally classified as B9zsa but later assigned to a new type, Bzs53 (Mougel et al., unpublished; Mougel, pers. comm.).

As far as relating the measurements on the pelvis to these other types is concerned, single specimens of various other types from Navarre (Bzs3, Bzs5, Bzs7 and Bzs10) plot out close to the B8zsa specimen, while 3 specimens of a further type, Bzs4, which is very close to B9zsa, are scattered over the central area amongst the B3 and B9 individuals.

The biggest limitation to associating the shape differences with the mtDNA types is that several of the types are only recorded from one locality or almost entirely from one locality. B10zsa is only recorded from Tudela, although 3 other animals assigned to B10 through their cytochrome-b were found at the nearby locality of Caparroso. B4zsa is almost entirely from Tour du Valat. As far as the measured pelvises are concerned, the only other specimens recorded as belonging to a B4 type are two B4zsa from Miranda de Arga and one from Caparroso, both in Navarre. However, the specimens from Miranda de Arga were subsequently reclassified as Bzs55 (Mougel et al., unpublished; Mougel, pers. comm.), which is considerably closer to B9zsa than to B4zsa. Unfortunately all three specimens are from young animals.

In order to understand better the relationships between the various control region types and the way in which they might have evolved, a tentative evolutionary tree has been constructed on the basis of the similarity of the types to each other. Initially it was thought more appropriate to compare populations (Mougel, 1997; Queney et al., 2001), but it has subsequently become evident that the probable introduction of rabbits of possible domestic ancestry brought from elsewhere into some populations confuses the results obtained. Grouping the rabbits by type and then studying the distribution of those types amongst the various populations gives better results.

In this particular case an evolutionary tree seems appropriate for various reasons. Firstly, mtDNA is simpler because it is single-locus and essentially non-recombining. Secondly, the types being compared are much more closely related than in most analyses, belonging not only to the same species but also to the same subspecies. Thirdly, the time period involved is short, most of the types presumably having diverged since the last glacial maximum some 25000 to 30000 years ago. Fourthly, since the control region, or at least large parts of it, does not have to code for amino acids, it is able to mutate freely, so that in practice the evolution seems to have followed a branching pattern rather than creating a network. The various branches generally unite sequences of similar geographical origins. Only in one case does it seem necessary to invoke convergent evolution.

The other part of the mtDNA genome for which much information is available is the cytochrome-b region. However, the ability of the this region to mutate freely is restricted by its need to

maintain functionality. The sequences, presumably as a consequence, tend to be related in a network with side-branches rather than a freely branching tree.

The sequences from the control region and the cytochrome-b are available from the NCBI database at <http://www.ncbi.nlm.nih.gov> and come from various sources (Van der Loo et al., 1997; Bolet et al., 2000; Letty et al., unpublished; Mougél et al., unpublished; Queney et al., 2002; Queney et al., unpublished; Long et al., 2003; Zenger & Richardson, unpublished; Seixas et al., 2014; Emam et al., unpublished). Four additional control region sequences from Table 1 in Branco et al. (2002) were added to the analysis and although they are rather shorter sequences than the others they fit in well and make good sense, one of them being a possible intermediate.

The fact that the control region sequences give much more information about the genetic variability than the RFLP analysis of Monnerot et al. (1994) means that the original classification is now outdated as a guide to the phylogeny of the rabbit and indeed it is not even mentioned by Seixas et al. (2014). However, the broad outline remains similar.

Monnerot et al. (1994) showed B8, B9 and B10 as the closest types to the A-lineage, with two main branches subsequently forming, one with B3 and B4 and the other with B1, B6 and B11. The new phylogenetic tree for the control region (Figure 21) shows three main branches forming at about the same time, one to B3 and B4, one to B8, B9 and B10 and one to B1, B6 and B11. The network shown by the cytochrome-b types is more like the original scheme, showing a branch to B8 and B9 at an early stage, then B3 and B4 close together in a network and finally a long branch to B1.

In the evolution of the control region shown in Figure 21, the main line coming from the A-lineage shows two early side-branches, to Bzs43 and Bzs30, and then a third branch to Bzs3 and Bzs29, before reaching an area in which it splits into three main lines. One of the lines leads to B8zsa, B9zsa, B10zsa and other similar types. Another line leads to B3zsa, B3zsc, B4zsa and related types. The third line leads to B1zsc, B6zsa and B11zsa. The most economical interpretation has the branch to B1, B6 and B11 going off before the branch to B8, B9 and B10 separates from the branch going to B3 and B4. It thus differs slightly from the pattern shown by the RFLP and the cytochrome-b sequences.

Of the Bzs types found in the specimens measured, types Bzs4 and Bzs53 are close to B9zsa in this new evolutionary tree. Bzs5 and Bzs55 are fairly close to B8zsa and B9zsa, while Bzs7 may have branched off slightly earlier. Bsz10 is very close to B11zsa.

The evolutionary tree in Figure 21 has been constructed using trial-and-error and common sense, following the principle of Occam's Razor, since the control region has its own patterns of evolution (Meyer et al., 1999; Howell et al., 2007; Endicott et al., 2009; Mignotte et al., 1990) and the commonly used computer programs make assumptions that are not necessarily valid. In particular, insertions and deletions are treated in the same way as substitutions, with the result that in this case the trees produced by computer programs often showed an insertion that was almost immediately deleted again, a highly implausible event. In any case, the methodology employed is itself very much open to debate (Farris, 1983; Kluge 1997; Haber, 2005). In the construction of the tree shown in Figure 21, biogeographical considerations have been taken into account as well as purely phylogenetic ones. In addition it has been possible to use a limited amount of information from the cytochrome-b sequences, since occasionally the two kinds of sequencing were carried out on the same specimen. This has allowed a possible convergent evolution of Bzs27 and Bzs29 to be detected (see Note 1).

For comparison, various parsimony analyses were carried out using version 3.696 of the program dnapars from the PHYLIP phylogeny inference package (Felsenstein, 1989; <http://evolution.gs.washington.edu/phylip.html>). Only the 314 sites shared by the majority of the control region sequences published in the NCBI database were used, corresponding to positions 15516 to 15827 in the complete mtDNA sequence published by Gissi et al. (1998), and so 111 distinct sequences were analysed. A large number of equally parsimonious trees were produced, one of which is shown in Figure 22. The overall parsimony score (including the outgroup) is in fact only slightly better than that for our own tree using the same sites, being 282 as opposed to 287.

The pattern shown by the main branches is much the same in all the trees and the large number of trees produced is the consequence of uncertainty in the positions at which they branch off. This in turn is the result of a concentration of the mutations in only a small number of sites. In the complete tree for the B-lineage from which Figure 21 is taken, nearly a third of the changes (77 out of 240) take place at only 10 of the sites. In the parsimony analyses the concentration shown was much the same, the tree shown in Figure 22 having 75 of the 232 changes occurring at only 10 sites.

The principal sites are always the same, so it seems that there are a number of genuine mutational hot-spots (Stoneking, 2000; Galtier et al., 2006). These hot-spots appear to be related to the secondary structure of the DNA (Pereira et al., 2008; Damas et al., 2012). No less than four of these hot spots are involved in the main branching area, so that both independent identical mutations at the same site and reverse mutations are not improbable. Consequently in that area the most economical tree is not necessarily the correct one. If one or two mutations occurred on more than one occasion or happened to be subsequently reversed, the branching pattern could easily come into line with that produced by the RFLP and cytochrome-b analyses.

Figure 23 shows a modified version of Figure 21 in which two mutations are duplicated in such a way as to bring the branching pattern into line with those shown by the RFLP and cytochrome-b analyses. The new parsimony score is 289.

The main branches in Figures 21, 22 and 23 are marked with the names of the corresponding RFLP types. However, it is evident that B3 includes three different groups, which have been labelled B3A, B3B and B3C in Figure 22, and that B4 is likely to correspond to at least two groups, since a comparison of the geographical distributions of the cytochrome-b and control region types in the unpublished study by Mougél et al. shows that at least some of the types in the group that includes Bsz40 must also belong to B4 (Mougél et al., unpublished; Mougél, pers. comm.).

Many of the types in the group that includes B3zsa are found in domestic rabbits, as are all the types in the B3zsb group. On the other hand, none of the types in the group that includes B3zsc are definitely domestic, although they are strongly associated with the spread of rabbits across northern France, which suggests that they might reflect the Mediaeval expansion of rabbits kept in warrens without being deliberately domesticated. It is interesting that the only B3 specimens recorded from the Peninsula are of type B3zsa (Mougél, 1997; Branco, 2002), which suggests that they are likely to be descended from introduced domestic stock.

The archaeological evidence from early sites in southern France that date from the Azilian to the Neolithic (Hardy et al. 1995) shows only cytochrome-b type B4sa, apart from a single example of type B4sb. The type could possibly be B3sa rather than B4sa, since footnote “c” to Table 2 says “mtDNA types B3sa and B4sa are distinguishable by RFLP in modern samples but not in the

cytochrome-b gene sequence used for ancient samples”; however, as we have shown, the corresponding control region B3zsa group is associated with modern domestic animals, so that the type is much more likely to be B4sa. Later sites that date to the Bronze Age and Gallo-Roman periods show almost entirely cytochrome-b type B3sc (equivalent to the control region B3zsc group). This suggests that the two B4 groups of control region types and the group including B3zsc might be the original groups that dominated in southern France prior to domestication (see also Callou, 2003, 243).

The precise area of the refugium, or perhaps refugia, for the B-lineage rabbits during the last glaciation is not at all clear. Although there is archaeological evidence for rabbits from quite far back into the glaciation, it is not until the final stages of the main glaciation that there is a rapid expansion of their range and clear evidence for their exploitation by humans, as for example at Cova Matutano, where a high proportion of the bones show cut-marks. However, even after that, the Younger Dryas cold event would have been a severe setback for rabbits and have affected the evolution of their populations in the recently colonised areas.

The Pyrenees would have remained a barrier during this initial expansion and essentially still are one at the present day. At the eastern end, the Cerdagne is the westernmost place on the crest of the range at which rabbits are found. At the western end, the range is continuous with the Cantabrian mountains and it would seem from the archaeological evidence that rabbits did not reach the north coast of the Peninsula until well into the Holocene.

Thus any genetic differences between the rabbits that spread across France and those that spread up the Ebro valley to Navarre would be perpetuated and become established over wide areas. On the one hand, B9zsa, B10zsa and types close to them are widespread on the south side of the Pyrenees but have not been recorded from France. On the other hand, B4zsa, Bzs40 and types close to them are widespread in southern France but there is only one specimen recorded from south of the Pyrenees. Similarly, B3zsc and types close to it have only been found north of the Pyrenees.

The distribution of the B1 types and also of B3zsa and types close to it cannot be relied upon as a guide to the origin of those types since they are types found in domestic rabbits and are likely to have been spread by human activity.

Discussion and Conclusions

It has been shown that there are differences in shape in the pelvis of rabbits from France and the Iberian Peninsula that are not merely due to differences in sex and age. These differences are associated with differences in the type of mtDNA. Unfortunately the association of type with shape is sometimes confined to only one or two populations and so may be due to chance, at least in part. However, if the associations are found to hold up when further samples are examined, measurement of the shape difference could be a useful way of tracing the evolution of archaeological populations. It could also be useful for detecting the presence of animals introduced into France from the Iberian Peninsula and vice versa. Such introductions would in turn presumably imply domestication or the processes leading to it.

More research is therefore urgently needed into the morphology of the pelvis of both ancient and modern rabbits in southern France and the Iberian Peninsula and then into their genetic affinities.

The eastern end of the Pyrenees and adjacent areas are of particular interest, since it is there that the divergence of different evolutionary branches must have occurred towards the end of the last glaciation. Such modern material as we have been able to examine from the south side of the eastern end of the Pyrenees shows the same extreme "Iberian" pelvis shape as the B10zsa specimens from Tudela or the samples from Matutano. The nature and position of the transition zone to the "French" shape remains to be established.

The extreme "French" shape of the B4zsa rabbits from Tour du Valat suggests that the shape difference might not be just a consequence of the spread of rabbits across France in Mediaeval times or of the processes leading to domestication, but may be a characteristic of populations from south-eastern France.

It would be particularly interesting to see whether a consistent shape difference exists in France, both in modern and in archaeological material, between individuals belonging to the B4 and B3zsc groups of types, those being apparently the types occurring in wild French rabbits prior to domestication. Unfortunately only two of the specimens measured can be assigned to B3zsc and although one of them plots out amongst the B4zsa specimens the other plots out far out on the left.

The B1 types, apart from B1zsc, and those in the B3zsa and B3zsb groups appear to be associated with deliberate breeding of domestic rabbits, so that individuals possessing them seem unlikely to be of entirely wild ancestry, at least in most cases. The origin of these types is therefore of great interest. B1zsc has only been recorded from England and since it is the earliest B1 type may well have arrived there in Mediaeval times with the spread of the fashion for creating warrens (Veale, 1957).

There have been suggestions that the B1 group may have originated in the Iberian Peninsula (Loreille et al., 1997; Callou, 2003), but unfortunately the published documentation is sparse and the analyses were of the cytochrome-b rather than the control region. In retrospect it seems unlikely that B1 should be found at a prehistoric site in the south of the Peninsula that is well within the zone of the A lineage, so the suspicion must be that at least in this case there was an intrusion of more recent material of domestic origin.

Finally, the results of the analysis made in the present study show that there is still room in zooarchaeology for measurements of the traditional kind. In recent years, geometric morphometrics has become fashionable, but conventional measurement has stagnated because of the almost universal adoption of the measurements proposed by von den Driesch (1976a, 1976b) and the associated obsession with orientation in certain fixed directions. This insistence on orientation was derived from Duerst (1926), who was concerned with comparative anatomy, but zooarchaeology has very different aims from comparative anatomy. Apart from giving a general idea of size, measurements in zooarchaeology serve to find small differences between closely related taxa or between different sexes. Orientation is irrelevant; precision and repeatability are the essentials.

In zooarchaeology, multivariate analysis has been little used except on the skull because there are usually too few well-defined measurements, and the skull suffers from the drawback that it is rarely found sufficiently intact in sufficient numbers on archaeological sites. Measurements on the postcranial skeleton have generally been too few in number, as well as too poorly defined, to provide enough precision.

Geometric morphometrics has played a positive part in so far as it has disrupted the *status quo* and stimulated an interest in a multivariate approach, but it is not without its own difficulties and limitations. Above all, precise and repeatable positioning of the landmarks is essential and not always easy in archaeological material. It would be as well to exhaust the possibilities of traditional measurements first.

There is thus a good deal of scope for the application of the methods presented here, both in archaeological material and in modern wild and domestic rabbits. Although genetics will inevitably have the last word in tracing the evolution and spread of the species and of the various domestic breeds, the role of this traditional metrical approach in combination with multivariate analysis could be that of finding the most profitable material for investigation.

Note 1

It is possible to associate some of the cytochrome-b types with control region types since in some cases both kinds of sequencing were carried out on the same specimen. The main consequence of this, as far as the present argument is concerned, is that a group of closely related control region types seem to belong to two different lines that have converged, the only instance in which convergent evolution needs to be invoked. One of these types, Bzs27, is from a specimen that has cytochrome-b type Bpbs14, which in turn can be classified as B3-4 from the way it is affected by the restriction enzyme AluI. Another type, Bzs29, is from a specimen that has cytochrome-b type Bpbs15, which in the same way can be classified as **not** belonging to B3-4. However, the restriction enzyme EcoR1 classifies both specimens as not being B8-10. This leaves the second specimen with the possibility of belonging to B1 or B11, but neither the cytochrome-b nor the control region sequence resembles the ones for these types. The conclusion must be that it belongs to an unknown RFLP type, presumably earlier in the evolutionary tree, and the control region sequence Bzs29 does indeed fit in well as part of an early side branch. Bzs3 is close to Bzs29 and since it is only found in Navarre is more likely to belong with it than to B3-4. The remaining types, Bzs18 and Bzs28, are on the same side-branch as Bzs27 and so have been provisionally treated as most likely to belong to B3-4.

Bibliography

- Barone, R., Pavaux, C., Blin, P.C. & Cuq, P. (1973). *Atlas d'anatomie du lapin*. Paris: Masson.
- Bergmann, C. (1847). Ueber die Verhältnisse der Wärmeökonomie der Thiere zu ihrer Grösse. *Göttinger Studien*, Abt. 1, 595-708.
- Biju-Duval, C., Ennafaa, H., Dennebouy, N., Monnerot, M., Mignotte, F., Soriguer, R.C., El Gaaied, A., El Hili, A. & Mounolou, J.-C. (1991). Mitochondrial DNA Evolution in Lagomorphs: Origin of Systematic Heteroplasmy and Organization of Diversity in European Rabbits. *Journal of Molecular Evolution* 33, 92-102.
- Bolet, G., Brun, J.M., Monnerot, M., Abeni, F., Arnal, C., Arnold, J., Bell, D., Bergoglio, G., Besenfelder, U., Bosze, S., Boucher, S., Chanteloup, N., Ducourouble, M.C., Durand-Tardif, M., Esteves, P.J., Ferrand, N., Gautier, A., Haas, C., Hewitt, G., Jehl, N., Joly, T., Koehl, P.F., Laube, T., Lechevestrier, S., Lopez, M., Masoero, G., Menigoz, J.J., Piccinin, R., Queney, G., Saleil, G., Surridge, A., van der Loo, W., Vicente, J.S., Viudes de Castro, M.P., Virag, J.S. & Zimmermann, J.M. (2000). Evaluation and conservation of European rabbit (*Oryctolagus cuniculus*) genetic resources. First results and inferences. *World Rabbit Science* 8, supplement 1, vol. A, 281-315. Proc. 7th World Rabbit Congress, Valencia, Spain, 4-7 July 2000.
- Branco, M., Ferrand, N. & Monnerot, M. (2000). Phylogeography of the European rabbit (*Oryctolagus cuniculus*) in the Iberian peninsula inferred from RFLP analysis of the cytochrome *b* gene. *Heredity* 85, 307-317.
- Branco, M., Monnerot, M., Ferrand, N. & Templeton, A.R. (2002). Postglacial dispersal of the European rabbit (*Oryctolagus cuniculus*) on the Iberian peninsula reconstructed from nested clade and mismatch analyses of mitochondrial DNA genetic variation. *Evolution* 56 (4), 792-803.
- Burke, A., Eisenmann, V. & Ambler, G.K. (2003). The systematic position of *Equus hydruntinus*, an extinct species of Pleistocene equid. *Quaternary Research* 59, 459-469.
- Callou, C. (2003). *De la garenne au clapier: étude archéozoologique du Lapin en Europe occidentale*. Mémoires du Muséum national d'Histoire naturelle 189. Paris: MNHN.
- Carneiro, M., Blanco-Aguilar, J.A., Villafuerte, R., Ferrand, N. & Nachman, M.W. (2010). Speciation in the European rabbit (*Oryctolagus cuniculus*): islands of differentiation on the X chromosome and autosomes. *Evolution* 64, 3443-3460.
- Carneiro, M., Baird, S.J.E., Afonso, S., Ramírez, E., Tarroso, P., Teotónio, H., Villafuerte, R., Nachman, M.W. & Ferrand, N. (2013). Steep clines within a highly permeable genome across a hybrid zone between two subspecies of the European rabbit. *Molecular Ecology* 22, 2511-2525.
- Carneiro, M., Albert, F.W., Afonso, S., Pereira, R.J., Burbano, H., Campos, R., Melo-Ferreira, J., Blanco-Aguilar, J.A., Villafuerte, R., Nachman, M.W., Good, J.M. & Ferrand, N. (2014). The Genomic Architecture of Population Divergence between Subspecies of the European Rabbit. *PLOS Genetics* 10 (8), 1-14.

- Damas, J., Carneiro, J., Gonçalves, J., Stewart, J.B., Samuels, D.C., Amorim, A. & Pereira, F. (2012). Mitochondrial DNA deletions are associated with non-B DNA conformations. *Nucleic Acids Research* 40 (16), 7606-7621.
- Davis, S.J.M. (1996). Measurements of a Group of Adult Female Shetland Sheep Skeletons from a Single Flock: a Baseline for Zooarchaeologists. *Journal of Archaeological Science* 23, 593-612.
- Davis, S.J.M., Gonçalves, M.J. & Gabriel, S. (2008). Animal remains from a Moslem period (12th/13th century AD) *lixreira* (garbage dump) in Silves, Algarve, Portugal. *Revista Portuguesa de Arqueologia* 11 (1), 183-258.
- Duerst, J. U. (1926). Vergleichende Untersuchungsmethoden am Skelett bei Säugern. In: *Handbuch der biologischen Arbeitsmethoden. Abt. VII. Methoden der vergleichenden morphologischen Forschung. Teil I* (E. Abderhalden, Ed.). Berlin & Wien: Urban & Schwarzenberg. pp. 125-530.
- Driesch, A. von den (1976a). *Das Vermessen von Tierknochen aus vor- und frühgeschichtlichen Siedlungen*. Munich: Institut für Paläoanatomie, Domestikationsforschung und Geschichte der Tiermedizin der Universität München.
- Driesch, A. von den (1976b). *A Guide to the Measurement of Animal Bones from Archaeological Sites*. Cambridge (Mass.): Harvard University. Peabody Museum Bulletin 1.
- Emam, A.M., Afonso, S., Azoz, A.A., González-Redondo, P., Mehaisen, G., Ahmed, N. & Ferrand, N. (unpublished). Origin and status of Egyptian local and Spanish common rabbits using mitochondrial DNA sequence analysis.
- Endicott, P., Ho, S.Y.W., Metspalu, M. & Stringer, C. (2009). Evaluating the mitochondrial timescale of human evolution. *Trends in Ecology and Evolution* 24 (9), 515-521.
- Farris, J. S. (1983). The logical basis of phylogenetic analysis. In: *Advances in Cladistics, Vol. 2*. (N. I. Platnick & V. A. Funk, Eds). New York: Columbia University Press. pp. 7–36.
- Felsenstein, J. (1989). PHYLIP - Phylogeny Inference Package (Version 3.2). *Cladistics* 5, 164-166.
- Galtier, N., Enard, D., Radondy, Y., Bazin, E. & Belkhir, K. (2006). Mutation hot spots in mammalian mitochondrial DNA. *Genome Research* 16, 215-222.
- Geraldes, A., Ferrand, N. & Nachman, M.W. (2006). Contrasting patterns of introgression at X-linked loci across the hybrid zone between subspecies of the European rabbit (*Oryctolagus cuniculus*). *Genetics* 173, 919–933.
- Geraldes, A., Carneiro, M., Delibes-Mateos, M., Villafuerte, R., Nachman, M.W. & Ferrand, N. (2008). Reduced introgression of the Y chromosome between subspecies of the European rabbit (*Oryctolagus cuniculus*) in the Iberian Peninsula. *Molecular Ecology* 17, 4489-4499.
- Gissi, C., Gullberg, A. & Arnason, U. (1998). The Complete Mitochondrial DNA Sequence of the Rabbit, *Oryctolagus cuniculus*. *Genomics* 50, 161-169.

- Gouy, M., Guindon, S. & Gascuel, O. (2010). SeaView version 4: a multiplatform graphical user interface for sequence alignment and phylogenetic tree building. *Molecular Biology and Evolution* 27 (2), 221–224.
- Haber, M.H. (2005). On Probability and Systematics: Possibility, Probability, and Phylogenetic Inference. *Systematic Biology* 54 (5), 831–841.
- Hardy, C., Casane, D., Vigne, J.D., Callou, C., Dennebouy, N., Mounolou, J.-C. & Monnerot, M. (1994). Ancient DNA from Bronze Age bones of European rabbit (*Oryctolagus cuniculus*). *Experientia* 50, 564-570.
- Hardy, C., Callou, C., Vigne, J.-D., Casane, D., Dennebouy, N., Mounolou, J.-C. & Monnerot, M. (1995). Rabbit Mitochondrial DNA Diversity from Prehistoric to Modern Times. *Journal of Molecular Evolution* 40, 227-237.
- Howell, N., Elson, J.L., Howell, C. & Turnbull, D.M. (2007). Relative Rates of Evolution in the Coding and Control Regions of African mtDNAs. *Molecular Biology and Evolution* 24 (10), 2213-2221.
- Jolicoeur, P. & Mosimann, J. E. (1960). Size and shape variation in the painted turtle. A principal component analysis. *Growth* 24, 339-354.
- Kluge, A.G. (1997). Testability and the Refutation and Corroboration of Cladistic Hypotheses. *Cladistics* 13, 81-96.
- Kuşatman, B. (1991). *The origins of pig domestication with particular reference to the Near East*. Ph.D thesis, Institute of Archaeology, University College London.
- Letty, J., Gautier, A., Monnerot, M., Queney, G., Bihannic, P., Dixneuf, S. and Marchandean, S. (2007). Les lapins de garenne de Béniguet: une singulière population insulaire. *Bulletin de la Société des sciences naturelles de l'Ouest de la France* 29 (3), 130-137.
- Letty, J., Gautier, A., Monnerot, M., Marchandean, S. and Queney, G. (unpublished). Presence of mitochondrial DNA of Iberian origin in European wild rabbit in Brittany (France).
- Lockley, R.M. (1965). *The Private Life of the Rabbit*. London: André Deutsch.
- Long, J.-R., Qiu, X.-P., Zeng, F.-T., Tang, L.-M. and Zhang, Y.-P. (2003). Origin of rabbit (*Oryctolagus cuniculus*) in China: evidence from mitochondrial DNA control region sequence analysis. *Animal Genetics* 34 (2), 82-87.
- Loreille, O., Mounolou, J.-C. & Monnerot, M. (1997). Histoire des lapins et ADN ancien. *Comptes Rendus des séances de la Société de Biologie et de ses filiales* 191 (4), 537-544.
- Mann, H.B. & Whitney, D.R. (1947). On a test of whether one of two random variables is stochastically larger than the other. *Annals of Mathematical Statistics* 18, 50-60.

- Martins, A., Neves, C., Costa, C. & Lopes, G. (2010). Sobre um conjunto de silos em Beja: a Avenida Miguel Fernandes. *Revista Portuguesa de Arqueologia* 13, 145-165.
- Mignotte, F., Gueride, M., Champagne, A.-M. & Mounolou, J.-C. (1990). Direct repeats in the non-coding region of rabbit mitochondrial DNA. Involvement in the generation of intra- and inter-individual heterogeneity. *European Journal of Biochemistry* 194, 561-571.
- Meyer, S., Weiss, G. & von Haeseler, A. (1999). Pattern of Nucleotide Substitution and Rate Heterogeneity in the Hypervariable Regions I and II of Human mtDNA. *Genetics* 152, 1103-1110.
- Monnerot, M., Vigne, J.D., Biju-Duval, C., Casane, D., Callou, C., Hardy, C., Mougel, F., Soriguer, R., Dennebouy, N. & Mounolou, J.C. (1994). Rabbit and man: genetic and historic approach. *Genetics Selection and Evolution* 26, Suppl. 1, 167s-182s.
- Mougel, F. (1997). Variation de trois types de marqueurs génétiques dans l'évolution de l'espèce *Oryctolagus cuniculus*: aspects moléculaires et relations avec la biologie et la structure des populations. Thèse de doctorat. Université de Paris-Sud, Orsay.
- Mougel, F., Gautier, A., Queney, G., Sánchez, M., Dennebouy, N. & Monnerot, M. (unpublished). History of European rabbit populations in France: advantage and disadvantage of mitochondrial DNA.
- Olària, C. (1999). Cova Matutano (Vilafamés, Plana Alta, Castellón). Un modelo ocupacional del magdalenense superior-final en la vertiente mediterránea peninsular. *Monografies de Prehistòria i Arqueologia Castellonenques* 5.
- Pereira, F., Soares, P., Carneiro, J., Pereira, L., Richards, M.B., Samuels, D.C. & Amorim, A. (2008). Evidence for variable selective pressures at a large secondary structure of the human mitochondrial DNA control region. *Molecular Biology and Evolution* 25, 2759-2770.
- Queney, G., Ferrand, N., Weiss, S., Mougel, F. & Monnerot, M. (2001). Stationary Distributions of Microsatellite Loci Between Divergent Population Groups of the European Rabbit (*Oryctolagus cuniculus*). *Molecular Biology and Evolution* 18 (12), 2169-2178.
- Queney, G., Gautier, A. and Monnerot, M. (unpublished). Characterization of rabbit populations in France.
- Queney, G., Vachot, A.-M., Brun, J.-M., Dennebouy, N., Mulsant, P. & Monnerot, M. (2002). Different Levels of Human Intervention in Domestic Rabbits: Effects on Genetic Diversity. *Journal of Heredity* 93 (3), 205-209.
- Seixas, F.A., Juste, J., Campos, P.F., Carneiro, M., Ferrand, N., Alves, P.C. and Melo-Ferreira, J. (2014). Colonization history of Majorca Island by the European rabbit, *Oryctolagus cuniculus*, and the Iberian hare, *Lepus granatensis* (Lagomorpha: Leporidae). *Biological Journal of the Linnean Society* 111 (4), 748-760.
- Siegel, S. (1956). *Nonparametric Statistics for the Behavioral Sciences*. New York: McGraw-Hill.

Stoneking, M. (2000). Hypervariable Sites in the mtDNA Control Region Are Mutational Hotspots. *American Journal of Human Genetics* 67, 1029-1032.

Sundberg, P. (1989). Shape and Size-Constrained Principal Components Analysis. *Systematic Zoology* 38, 166-168.

Van der Loo, W., Mougél, F., Sánchez, M. S., Bouton C., Castien E., Soriguer, R., Hamers, R. & Monnerot, M. (1997). Evolutionary patterns at the antibody constant region in rabbit (*Oryctolagus cuniculus* L.): Characterisation of endemic *b*-locus allotypes and their frequency correlations with major mitochondrial gene types in Spain. *Gibier Faune Sauvage* 14 (3), 427-449.

Veale, E.M. (1957). The Rabbit in England. *Agricultural History Review* 5, 85-90.

Watson, J.P.N. (1999). *Análisis Preliminar de los Mamíferos del Sector 3 de Cova Matutano (Vilafamés, Castellón)*. Sant Cugat del Vallès: Arpali.

Zenger, K.R. & Richardson, B.J. (unpublished). Genetic variation and evolution of a colonizing species: the mitochondrial DNA control region in the European rabbit (*Oryctolagus cuniculus*) in Australia.

Figures:

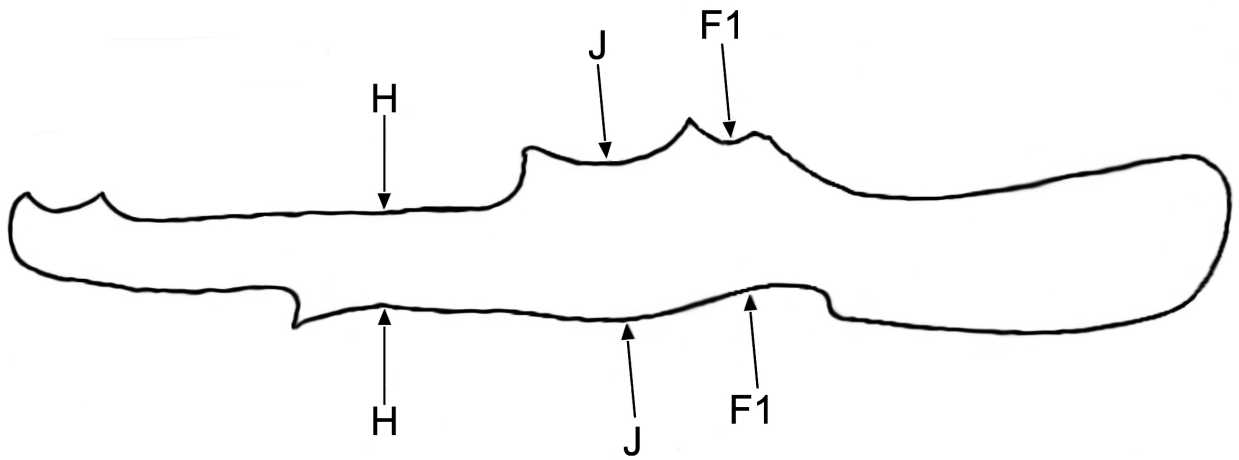

Figure 1. Drawing showing the approximate positions in which the measurements H, J and F1 are taken.

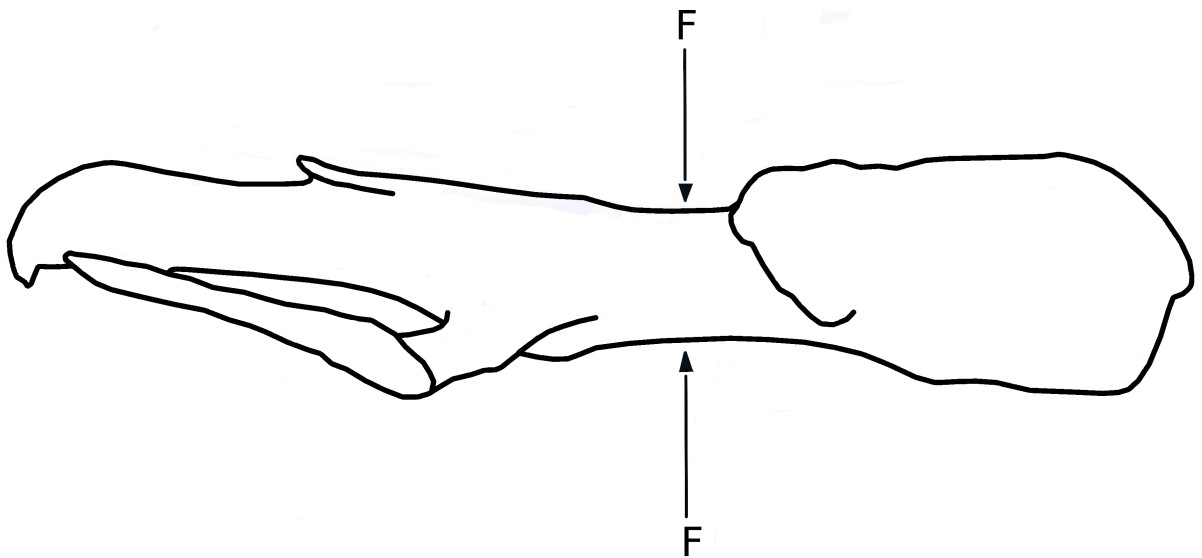

Figure 2. Drawing showing the approximate position in which the measurement F is taken.

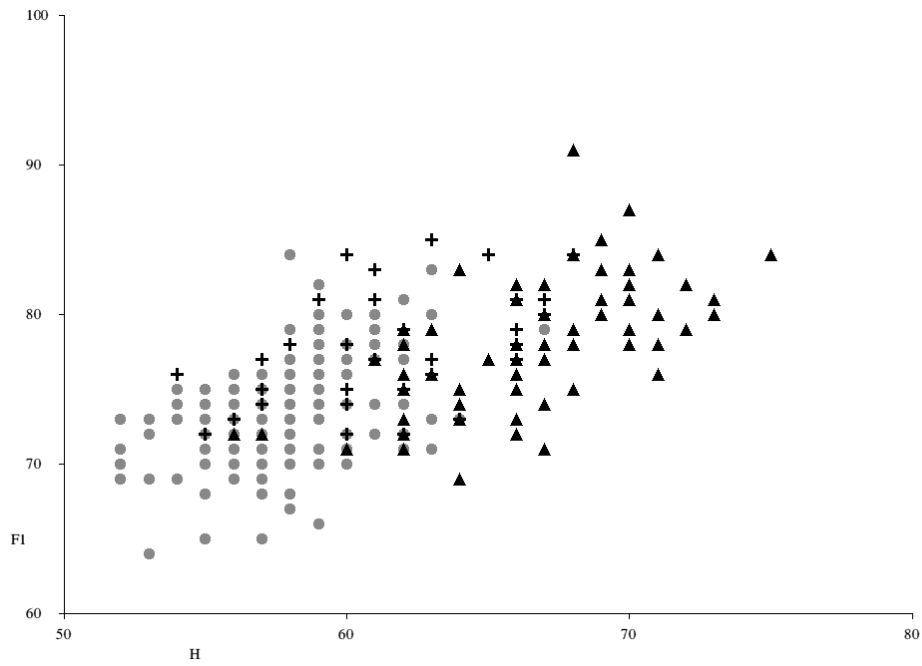

Figure 3. The result of plotting F1 against H. The grey circles represent Las Lomas, Badajoz, Vila Viçosa and Santarém, the sites from the south-west of the Iberian Peninsula. The black crosses represent Peralta and Tudela, the sites from Navarre. The black triangles represent the French sites of Roissy, Versailles and Tour du Valat.

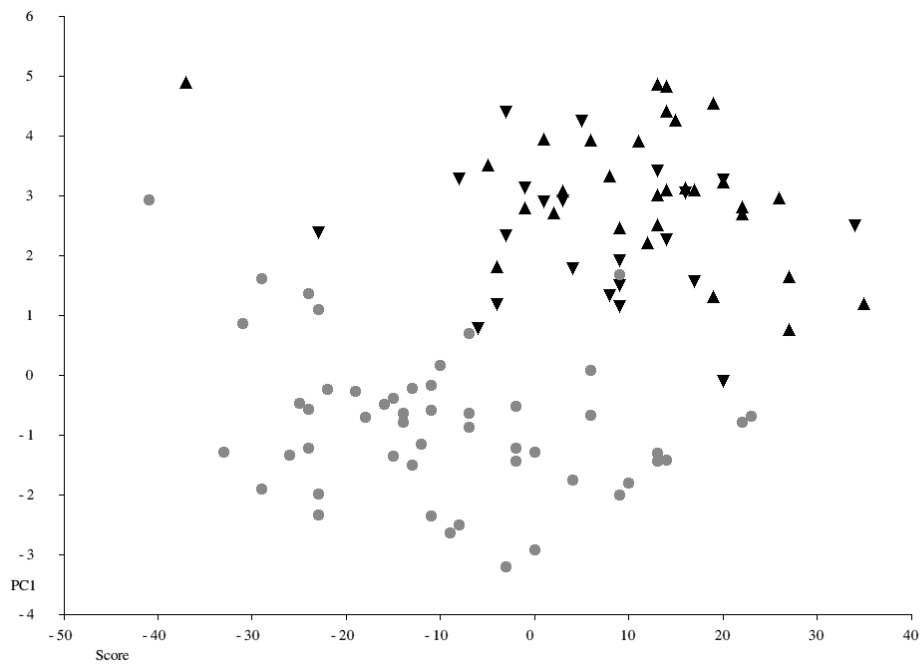

Figure 4. The first principal component plotted against the discriminant score obtained by using Roissy and Versailles as one of the groups in the discriminant analysis and Las Lomas as the other group. The individual specimens for the three sites are plotted, those from Las Lomas as grey circles, those from Roissy as black triangles and those from Versailles as black inverted triangles.

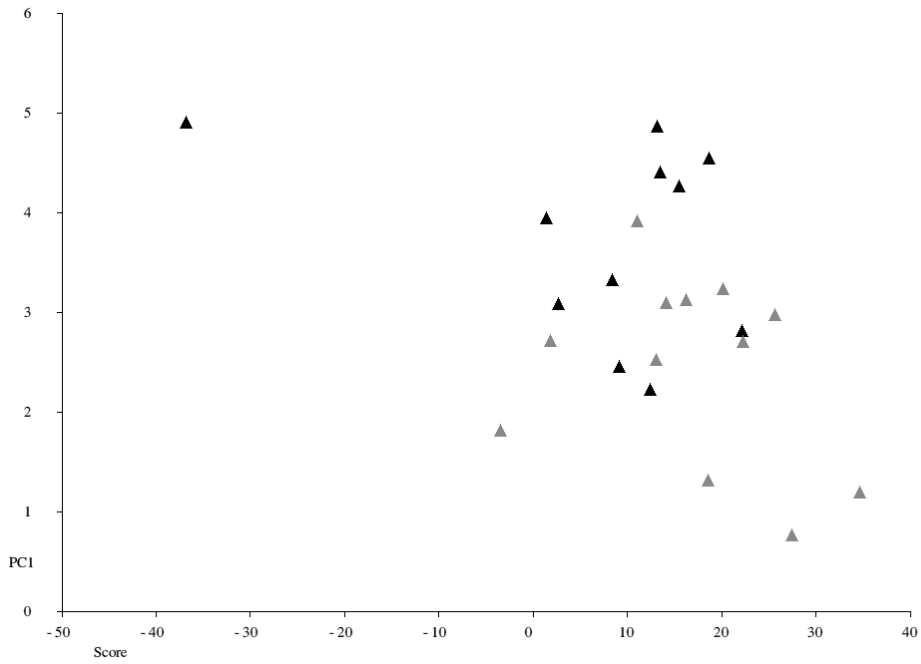

Figure 5. The first principal component plotted against the discriminant score for the Roissy specimens that had been identified to sex. Males are represented by black triangles and females by grey ones. It can be seen that although there is a certain difference between the sexes, it is mainly a difference in size. The difference in discriminant score is small compared to the difference between the scores for the Roissy specimens as a whole and those from Las Lomas. The isolated male on the extreme left has had its measurements retaken and is a genuine outlier.

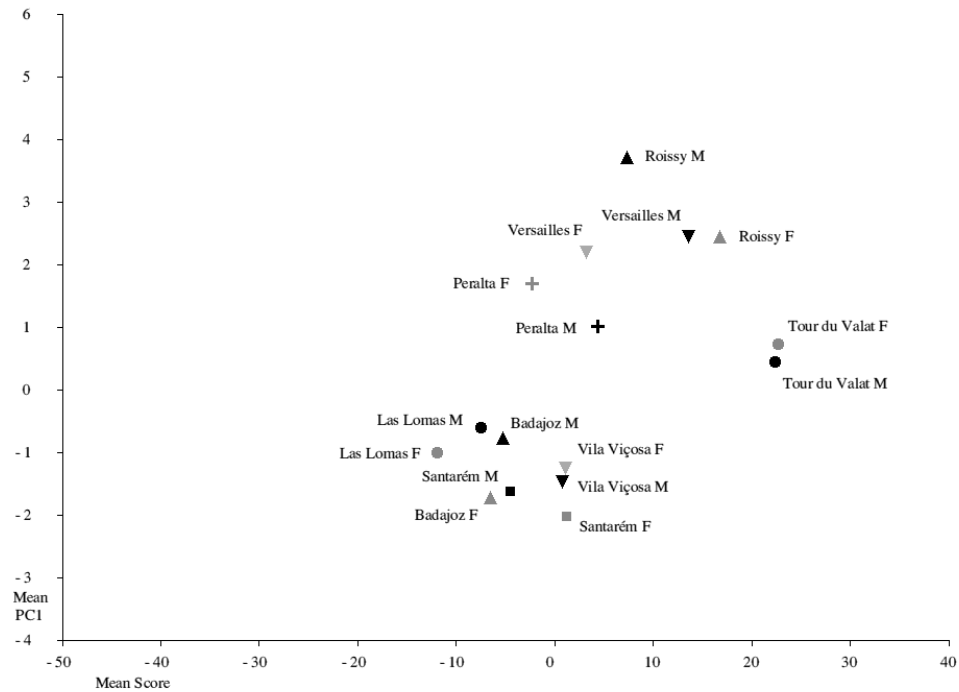

Figure 6. The means of the first principal components plotted against the means of the discriminant scores for the males and females for each site.

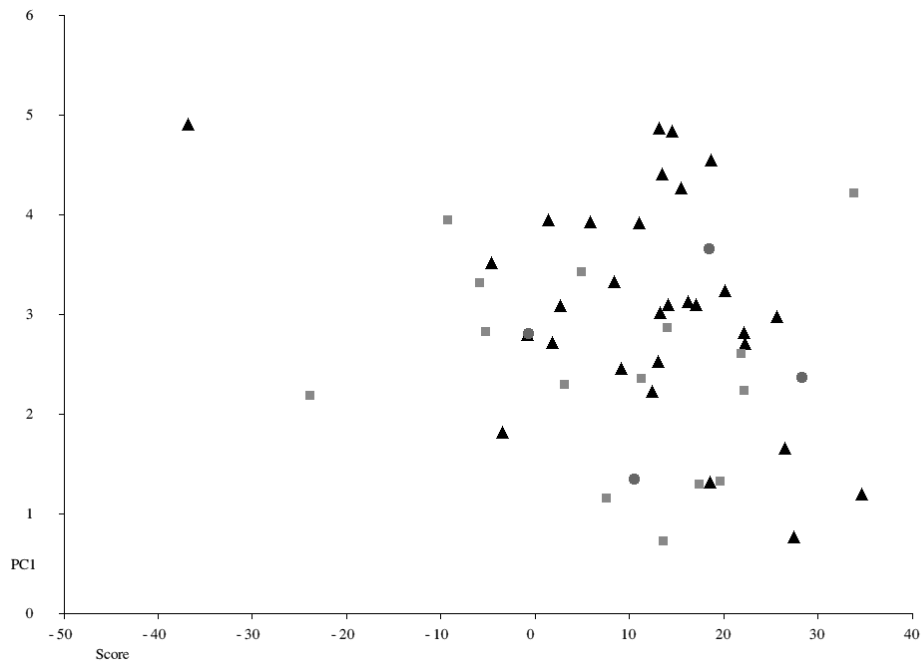

Figure 7. The first principal component plotted against the discriminant score for Roissy specimens of different ages. The black triangles represent those specimens for which the corresponding proximal humerus is fully fused, the dark grey circles represent those for which its fusion plane is still visible and the light grey squares represent those for which it is still unfused.

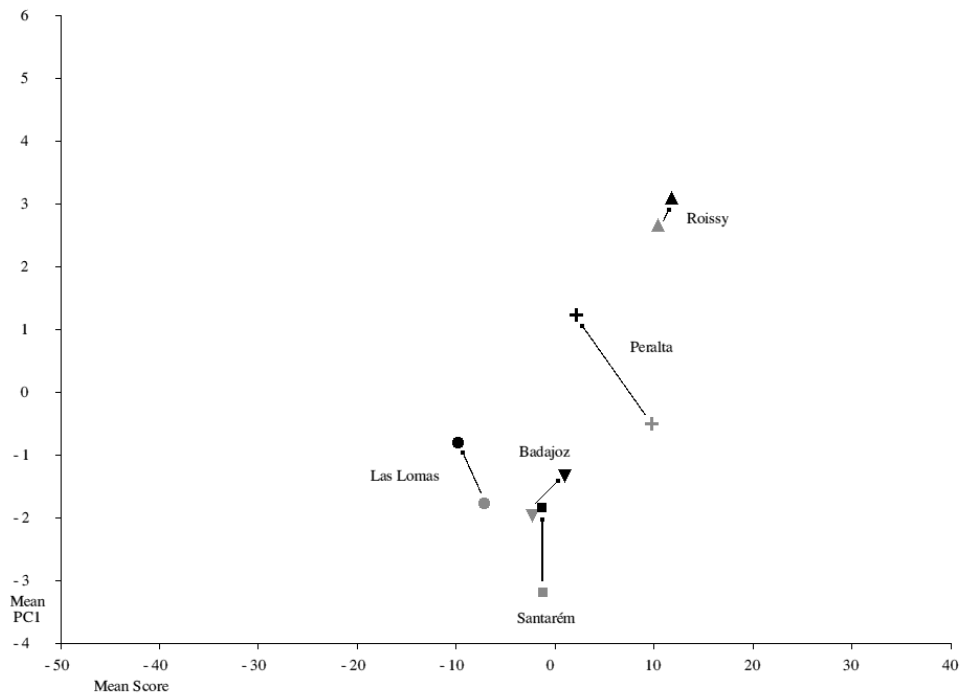

Figure 8. The means of the first principal components plotted against the means of the discriminant scores for the specimens for which the corresponding proximal humerus is fully fused (in black) and those for which it is incompletely fused or unfused (in grey).

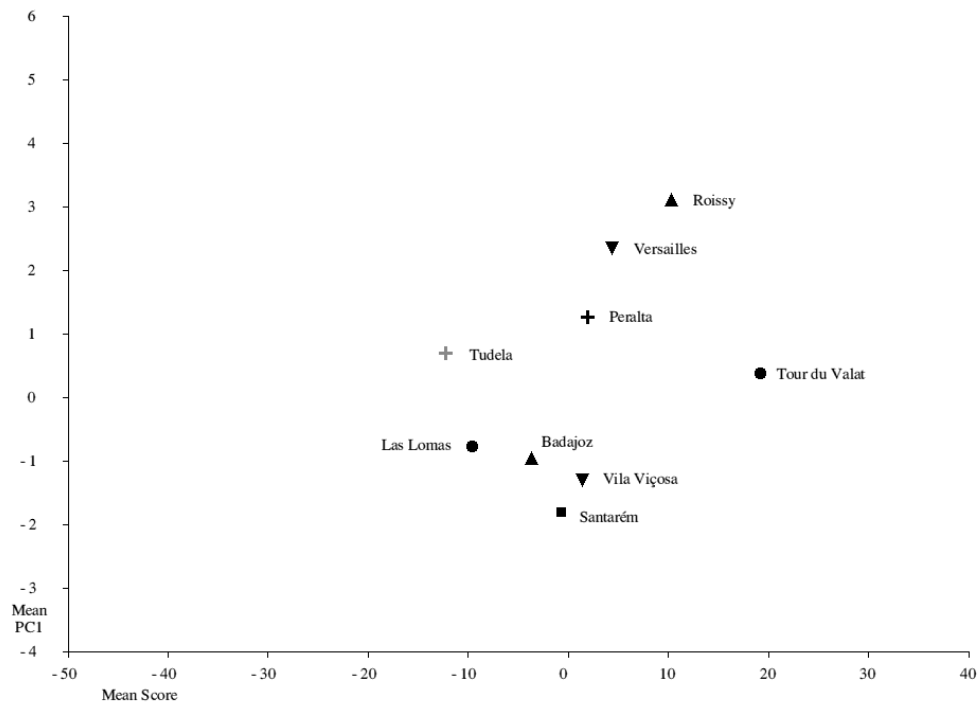

Figure 9. The means of the first principal components plotted against the means of the discriminant scores for the adults from the same 9 sites as in Figure 3.

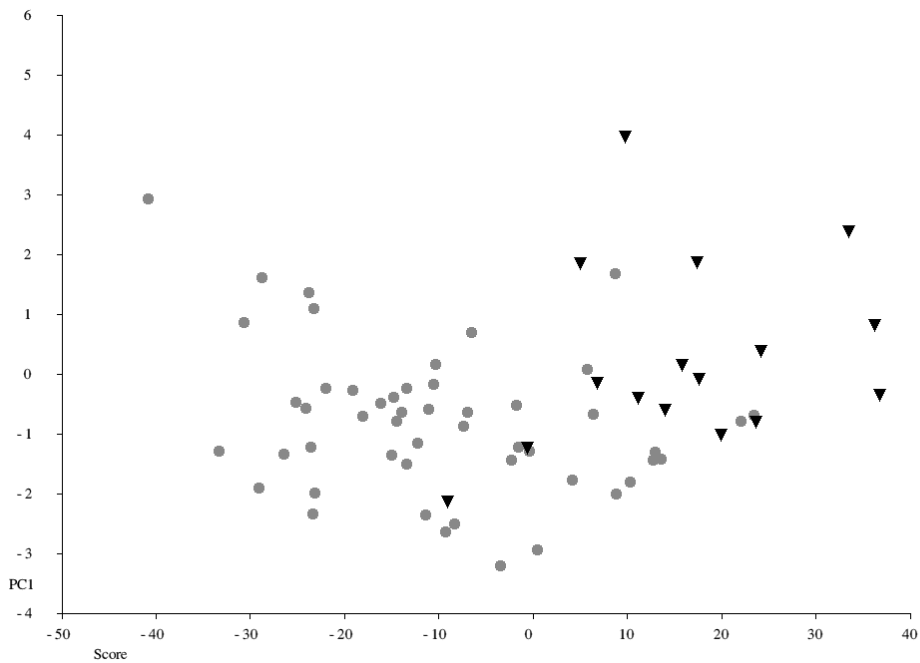

Figure 10. The first principal component plotted against the discriminant score for the individual adult specimens from Tour du Valat (black inverted triangles) and Las Lomas (grey circles).

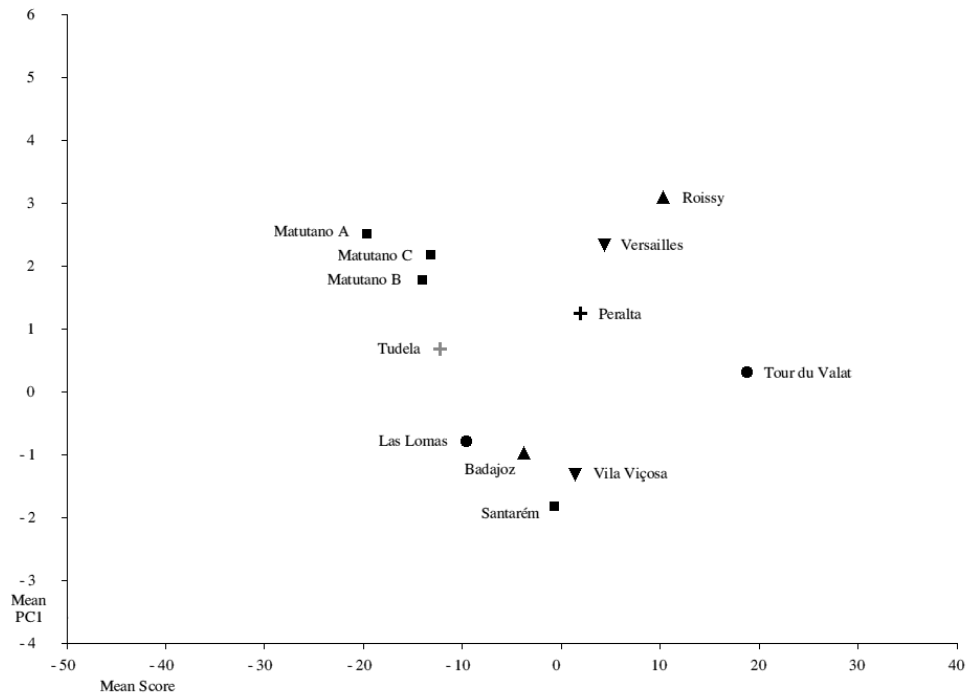

Figure 11. The means of the first principal components plotted against the means of the discriminant scores for the adults from the 9 modern samples, as in Figure 9, together with those for the specimens from faunal phases A, B and C at Cova Matutano.

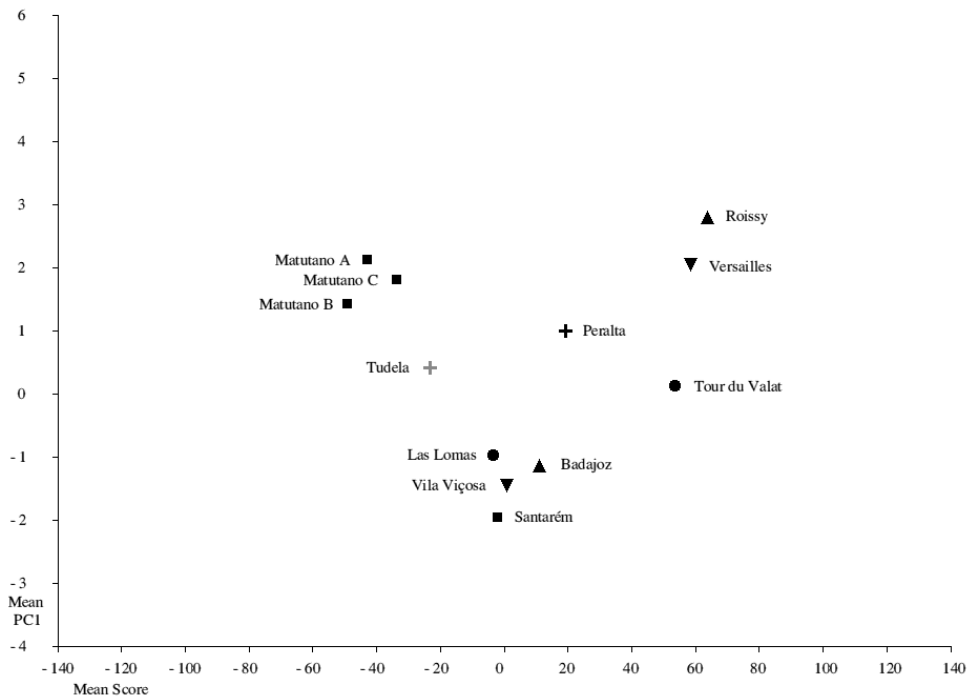

Figure 12. The means of the first principal components plotted against the means of the discriminant scores for the same specimens as in Figure 11, but with a new discriminant function obtained by using Roissy as one of the groups in the discriminant analysis and Matutano A as the other. In addition, the specimens from Matutano, Beja and Silves are now included in the calculation of the principal components.



Figure 13. A map showing the locations of the sites, together with the transition zone (in grey) between the lineages A and B (after Branco et al., 2002 and Geraldès et al., 2008).

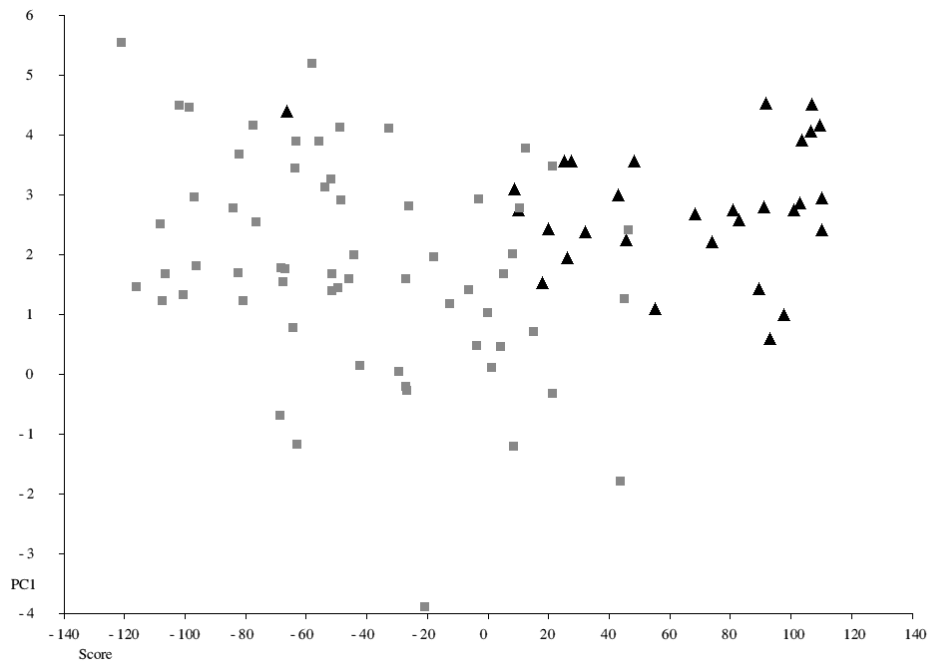

Figure 14. The first principal component plotted against the discriminant score for the individual specimens from Matutano A, B and C (grey squares) and the adult specimens from Roissy (black triangles), using the new principal components and discriminant function.

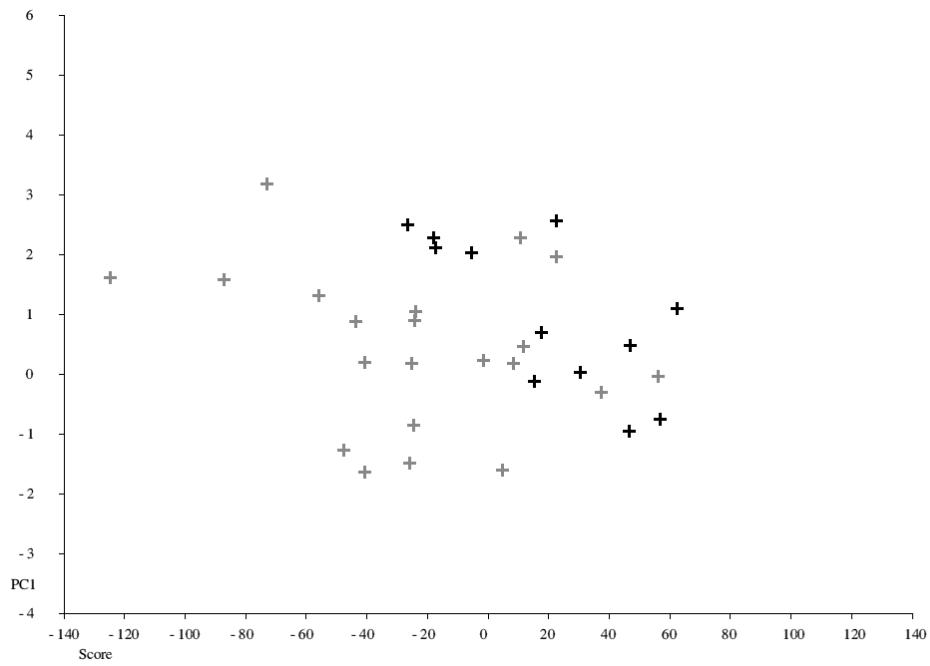

Figure 15. The first principal component plotted against the discriminant score for the individual adult specimens from Tudela (grey crosses) and Peralta (black crosses), using the new principal components and discriminant function.

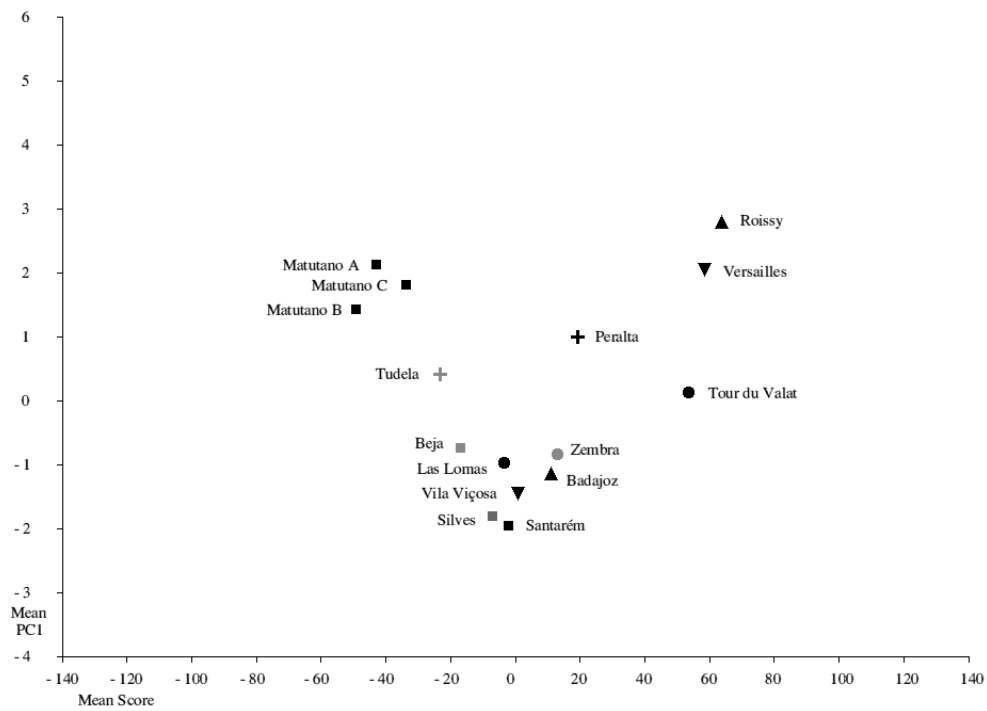

Figure 16. The means of the first principal components plotted against the means of the discriminant scores for the same specimens as in Figure 12, but with the archaeological sites of Beja and Silves added, together with the adult specimens from a modern sample from the Tunisian island of Zembra.

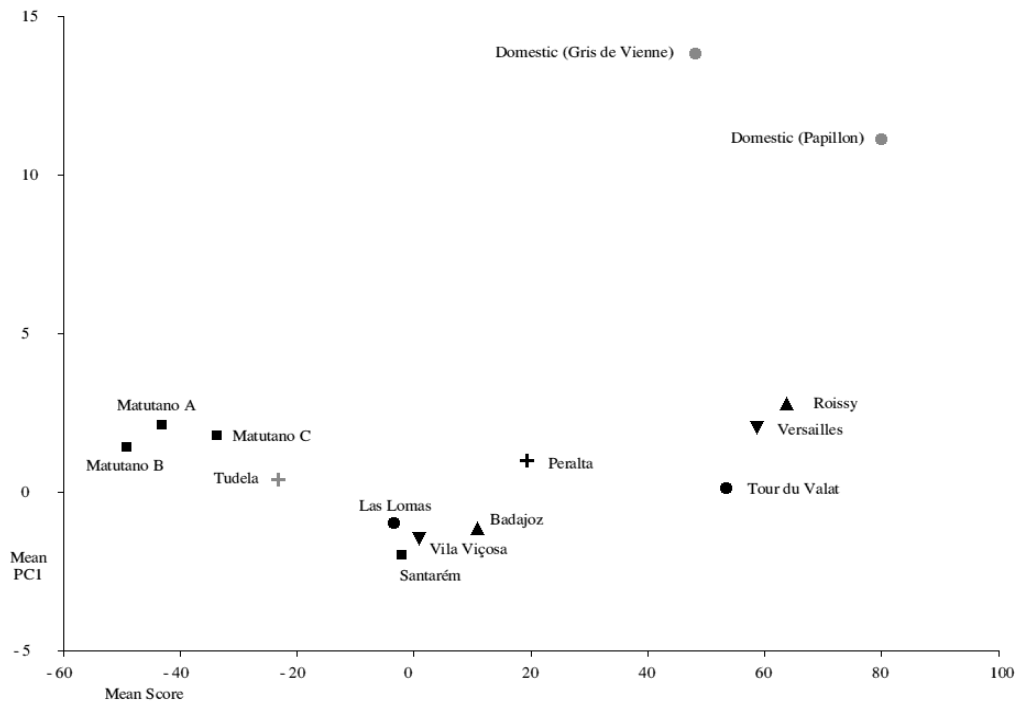

Figure 17. The means of the first principal components plotted against the means of the discriminant scores for the same specimens as in Figure 12, with the addition of the means for a few domestic specimens of the Gris de Vienne and Papillon breeds. The range on the horizontal axis has been reduced, so that the mean discriminant scores appear more spread out than in Figure 12.

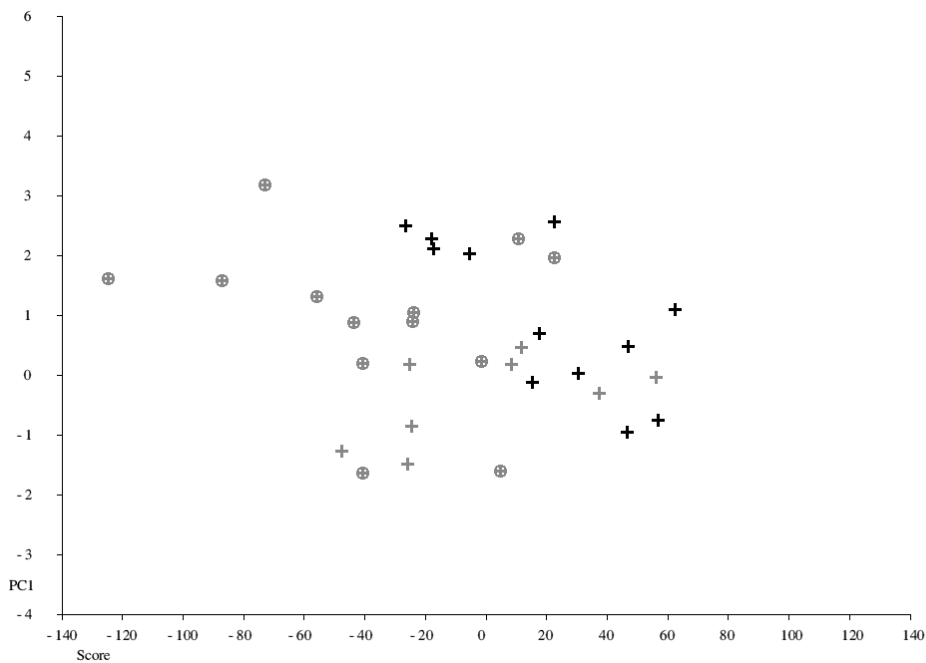

Figure 18. Tudela and Peralta as in Figure 15, but with the type B10 specimens from Tudela indicated by the addition of a circle.

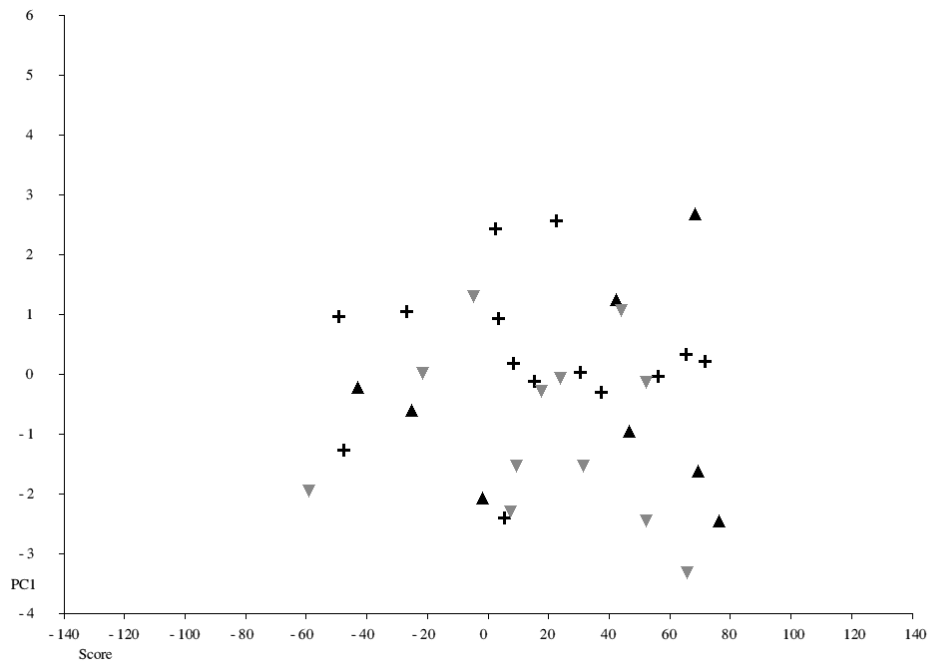

Figure 19. Specimens with mtDNA types B3 (black triangles), B6 (grey inverted triangles) and B9 (black crosses).

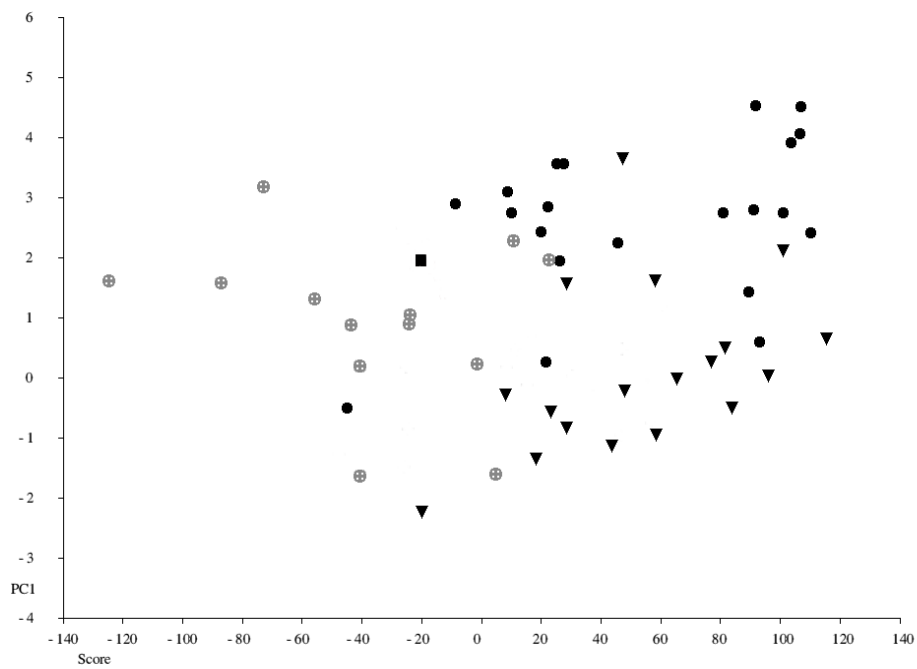

Figure 20. Specimens with mtDNA types B1 (black circles), B4 (black inverted triangles) and B10 (grey crosses within a circle). The B4 specimens are all from Tour du Valat and the B10 ones are all from Tudela. The single B8 specimen is also shown and is indicated by a black square.

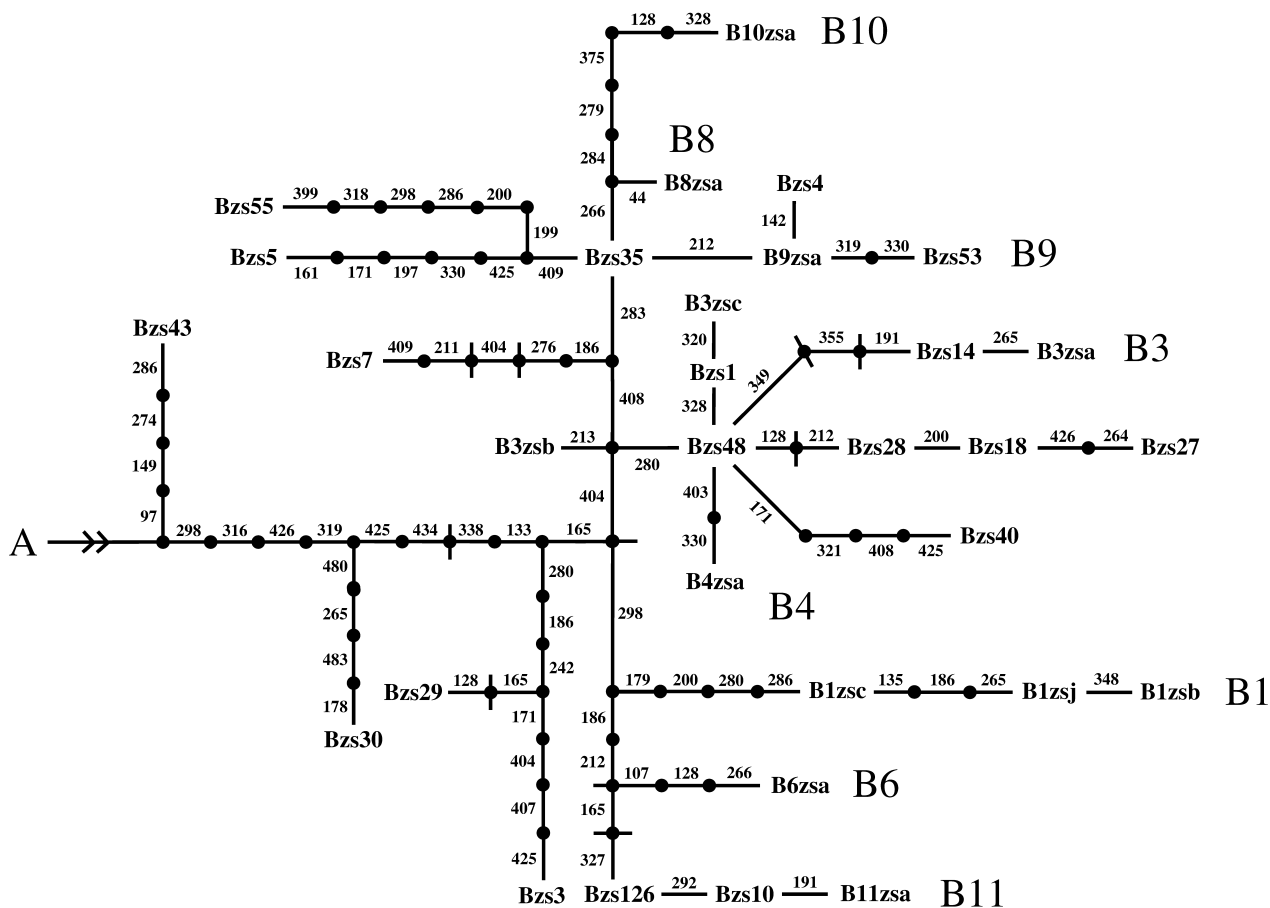

Figure 21. Proposed phylogeny of the main mtDNA control region types discussed. In order to keep the diagram as simple as possible, most types that are not referred to in the text, or that are not intermediate types on branches to types referred to in the text, have been excluded. Postulated intermediate types that have not so far been recorded are marked by black dots. A bar across a black dot indicates the existence of a side-branch at that point. The evolutionary development begins on the left, where there are 55 differences between the closest member of the A lineage and the start of the branch leading to Bzs43. The symbols in large print are the corresponding RFLP types of Monnerot et al. (1994). The number given to each link is the position of the difference between the two sequences, relative to the beginning of the longest sequence used in the matching. Since the complete mtDNA sequence of Gissi et al. (1998) differs from the sequences compared here in an insertion and up to three deletions, the following values need to be added in order to obtain the positions in that sequence: 15395 to positions 1 to 126; 15394 to positions 128 to 282; 15392 to positions 285 to 296; 15393 to positions 297 to 571. The positions 283 and 284 shown here do not exist in the sequence of Gissi et al. (1998) and the links constitute insertions. The order of the numbers in a series of links between branching points is of course arbitrary. All detectable mutations between positions 1 and 571 have been shown, but since the sequences are of different lengths there may be other mutations that could not be detected; thus it is possible that a type might be on a short side-branch from the position it is shown at, rather than at the position itself.

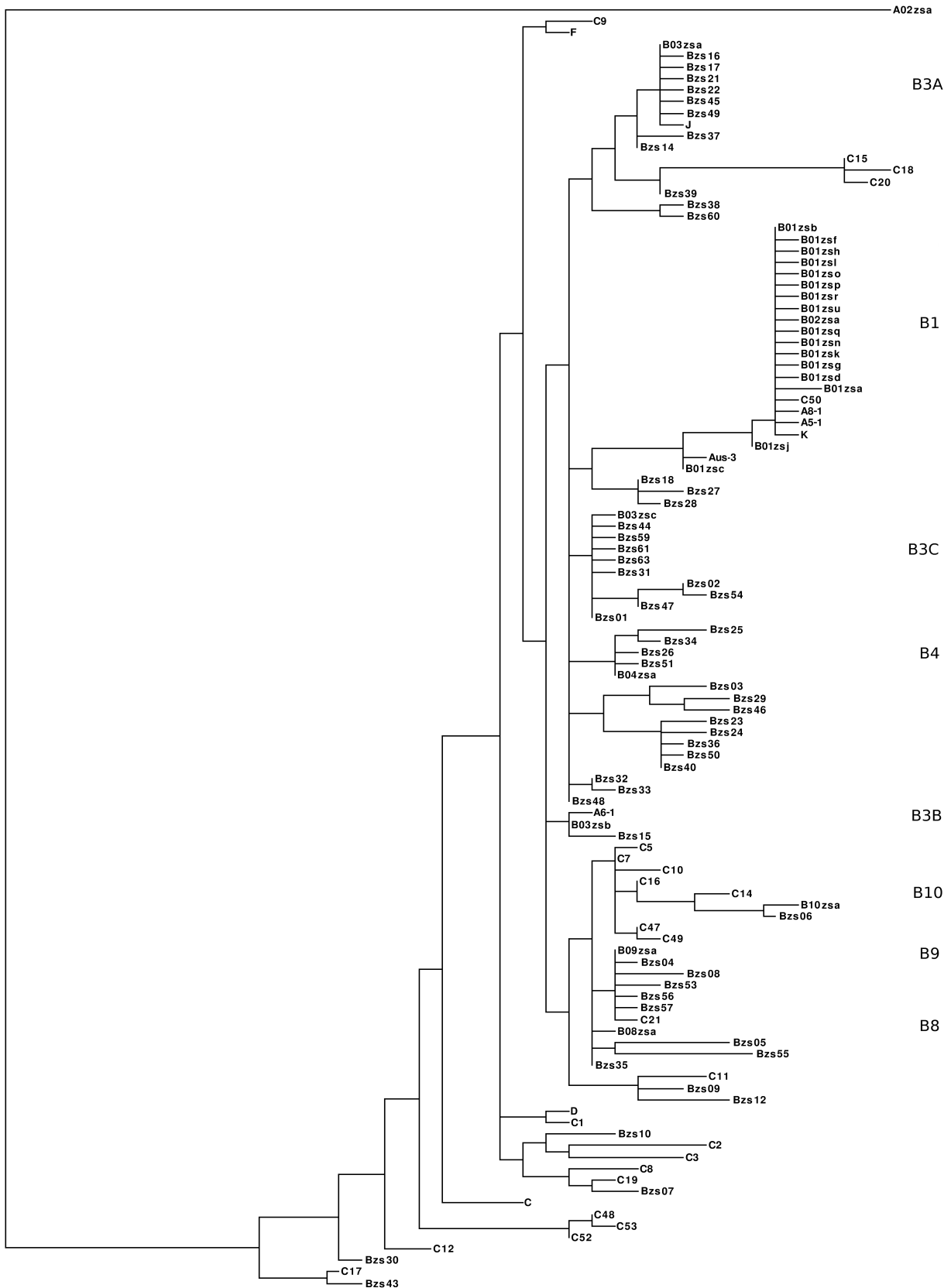

Figure 22. A tree produced by the PHYLIP program **dnajpars** (Felsenstein, 1989) from the 111 sequences in the NCBI database that share positions 15516 to 15827 in the complete mtDNA sequence published by Gissi et al. (1998). The haplotype A02zsa from Lineage A has been used as the outgroup. On the right the names of the RFLP types are shown opposite the branches that include the corresponding haplotype, except that B3 is split into subtypes B3A, B3B and B3C since the haplotypes B03zsa, B03zsb and B03zsc are distributed across three different branches. The tree has been plotted with SeaView (Gouy et al. 2010).

	B3	B4	B6	B9	B10	n
B1	>0.1	>0.1	<0.05	<0.02	<0.002	21
B3	-	>0.1	>0.1	>0.1	<0.02	8
B4	-	-	0.02	<0.02	<0.002	18
B6	-	-	-	>0.1	0.002	12
B9	-	-	-	-	<0.02	14
B10	-	-	-	-	-	13
n	8	18	12	14	13	

Table 1. Probabilities of obtaining differences between types as large as those found, according to the Mann-Whitney U test, on the assumption that there had been in fact no difference between the populations. The tables used are in Siegel (1956) and Mann & Whitney (1947).

Appendix 1:

Definitions of the measurements taken.

Figures 1 and 2 show the approximate positions in which the measurements are taken. All the measurements are taken with a vernier gauge with "knife-edge" blades (i.e. they should have reasonably narrow edges, although that is only really important for F1).

The formal definitions are as follows:

H = minimax diameter of ischial shaft, between the acetabulum and the *spina ischiadica*.

I = absolute minimum diameter of ischial shaft (usually in the same place as H, but sometimes much more caudal).

J = minimum height of the lateral side of the acetabulum, i.e. the minimax. This is only just possible in lagomorphs, one of the blades of the vernier gauge lying almost flat against the back of the acetabulum (i.e. the medial side). It also needs a certain delicacy of touch because the edge of the acetabulum is easily damaged. In addition the acetabulum needs to be fully fused.

E = absolute minimum diameter of the shaft of the ilium. This is very oblique in rabbit, about 45 degrees to the axis of the ilium. It should not enter the area of fusion with the sacrum (which it very occasionally tends to do).

F = minimax diameter of the shaft of the ilium, usually the absolute minimax but sometimes a local minimax. The measurement is near to or equivalent to the dorso-ventral height in most cases (the KH or SH of von den Driesch), but taken as a minimax. However, in some cases, when the *spina iliaca dorsalis caudalis* extends a long way caudally, this is only a local minimax and the absolute minimax is further round, more or less parallel to F1. Sometimes it is difficult to take because the depression on the ventral side of the *spina iliaca ventralis caudalis* is very shallow and the bone then has to be placed right between the tips of the blades of the vernier gauge in order to find the minimax.

F1 = minimax diameter of the shaft of the ilium with one blade of the vernier gauge placed between the edge of the acetabulum and the *spina iliaca ventralis caudalis*. One needs to be careful to avoid damaging the *spina*.

For detailed drawings and nomenclature see Barone et al. (1973, 24).

Appendix 2:

List of measurements, by site.

Column 1 shows SJMD's reference number, except in the case of Cova Matutano, where the number is that used by JPNW in the study of the site.

For the modern material, the information given in the remaining columns is as follows:

Column 2 shows the number given in the register of the Muséum national d'Histoire naturelle (MNHN).

Column 3 shows the reference number used by Callou (2003).

Column 4 shows the sex, when determined; M = male; F = female.

Column 5 shows the state of fusion of the proximal humerus: f = fully fused; fv = fusion plane still visible; u = unfused.

Columns 6 to 11 show the measurements in millimetres.

For Cova Matutano, Column 2 shows the old level name and the depth in centimetres, while Column 3 shows the faunal phase defined in Watson (1999).

Arjuzanx:

No.	MNHN ref.	Callou ref.	Sex	Fusion	F1	F	E	J	H	I
342	2001.136	AX4	-	f	8.3	7.5	4.4	8.2	6.9	3.3
346	2001.135	AX3	-	f	7.9	7.6	4.2	7.7	6.4	3.0
348	2001.134	AX2	-	f	7.9	6.8	3.8	7.7	6.0	3.0

Arróniz:

No.	MNHN ref.	Callou ref.	Sex	Fusion	F1	F	E	J	H	I
278	2001.130	AZ	-	f	7.1	6.2	3.6	7.4	5.7	2.7

Badajoz:

No.	MNHN ref.	Callou ref.	Sex	Fusion	F1	F	E	J	H	I
118	2001.177	BD6	M	f	8.0	7.0	3.7	7.8	6.0	3.3
119	2001.181	BD10	F	f	6.9	6.0	3.5	6.2	5.2	2.9
120	2001.187	BD16	F	-	7.6	7.0	3.7	7.6	6.4	3.3
121	2001.174	BD3	F	f	8.0	7.2	4.6	7.2	6.0	3.4
122	2001.186	BD15	F	-	7.4	6.5	4.4	7.1	6.0	3.4
123	2001.185	BD14	M	f	7.5	6.5	3.8	6.9	5.7	3.1
124	2001.180	BD9	M	f	7.5	6.7	4.0	6.9	5.5	2.9
125	2001.173	BD2	M	f	7.1	6.6	3.8	6.7	5.6	3.4
126	2001.176	BD5	M	f	7.6	6.5	3.8	7.3	6.0	3.3

127	2001.175	BD4	F	f	7.0	6.3	4.2	6.9	5.8	3.1
128	2001.182	BD11	F	f	7.4	6.4	3.6	7.2	5.9	2.7
129	2001.172	BD1	M	f	7.4	6.7	4.3	7.1	6.1	3.1
130	2001.179	BD8	M	f	7.5	6.4	3.8	7.0	5.9	3.4
131	2001.178	BD7	M	f	7.3	7.2	4.2	7.4	6.3	3.5
132	2001.184	BD13	F	f	7.6	6.0	3.4	6.6	5.4	3.2
133	2001.183	BD12	M	f	7.2	6.3	3.9	6.9	5.5	2.8

Caparroso:

No.	MNHN ref.	Callou ref.	Sex	Fusion	F1	F	E	J	H	I
257	2001.127	CAP4	-	f	6.9	6.6	3.5	6.9	6.0	2.7
730	2001.129	CAP6	M	f	8.3	7.3	4.1	7.3	6.2	3.3

Castejón:

No.	MNHN ref.	Callou ref.	Sex	Fusion	F1	F	E	J	H	I
277	2001.131	CN1	-	f	7.9	6.7	4.4	7.9	5.9	3.5

Donzère:

No.	MNHN ref.	Callou ref.	Sex	Fusion	F1	F	E	J	H	I
146	2001.53	DO1	-	f	7.6	6.7	3.8	7.5	5.8	3.3
147	2001.54	DO2	-	f	7.7	6.8	4.2	7.6	6.2	3.1

Falces:

No.	MNHN ref.	Callou ref.	Sex	Fusion	F1	F	E	J	H	I
248	2001.82	FA1	F	f	7.4	6.4	4.0	7.5	5.8	3.4
249	2001.83	FA2	F	f	6.8	6.5	3.6	7.4	5.5	3.1

Las Lomas:

No.	MNHN ref.	Callou ref.	Sex	Fusion	F1	F	E	J	H	I
271	1991.57	R34	F	f	7.1	6.1	4.1	6.9	5.2	3.4
272	1991.34	R4	M	f	7.3	7.0	3.9	7.0	5.9	3.2
273	1991.56	R33	F	f	8.0	6.5	3.7	7.3	5.9	2.9
274	1991.53	R30	M	f	7.6	6.5	4.3	7.1	5.9	3.3
275	2001.157	LL86	M	u	6.6	5.6	3.3	6.8	5.5	2.8
276	2001.154	LL83	F	f	6.9	6.3	4.2	7.2	5.6	2.9
280	2001.166	LL95	F	fv	6.5	5.5	3.6	6.1	5.1	3.1
281	2001.161	LL90	F	f	7.4	6.6	3.8	6.8	5.6	3.3
282	2001.156	LL85	F	fv	7.1	6.3	3.5	6.6	5.2	2.7

283	2001.167	LL96	M	f	7.6	6.6	3.7	7.7	6.0	3.3
284	2001.152	LL81	F	f	7.1	6.4	3.9	7.1	5.8	3.3
285	2001.162	LL91	F	f	7.6	6.4	4.2	7.9	5.6	2.9
286	2001.160	LL89	F	f	7.6	6.4	4.0	7.0	5.8	3.5
287	2001.163	LL92	M	f	7.3	6.6	4.2	7.1	5.9	3.3
288	2001.164	LL93	F	f	7.4	6.7	4.1	7.2	6.2	2.8
289	2001.153	LL82	M	f	7.6	6.1	4.1	7.2	6.0	3.1
290	2001.147	LL76	M	fv	7.7	6.8	3.8	7.4	5.7	3.8
291	2001.159	LL88	M	f	7.4	6.3	3.6	7.1	6.2	3.0
292	2001.141	LL70	M	f	7.4	6.3	3.6	6.7	5.5	3.0
293	1991.60	R39	F	f	7.4	6.2	3.9	6.7	5.4	3.2
294	1991.47	R22	F	f	7.5	7.0	3.5	7.1	5.7	3.0
295	1991.59	R38	M	f	7.8	6.8	4.1	7.3	6.0	3.8
296	1991.54	R31	M	f	7.4	6.4	3.9	7.2	6.0	3.4
297	1991.40	R14	F	f	6.9	6.2	3.5	6.9	5.4	3.0
298	1991.58	R36	M	f	7.8	7.2	4.0	7.4	6.1	3.3
299	1991.33	R1	F	fv	7.0	6.3	4.2	6.8	6.1	3.1
300	1991.46	R20	F	f	7.2	6.3	3.7	6.8	5.3	2.9
301	1991.62	R41	F	fv	6.9	6.6	3.9	7.3	5.5	3.3
302	1991.48	R23	M	f	7.3	6.2	4.1	6.5	5.2	3.1
303	1991.61	R40	F	f	7.5	6.9	3.9	6.8	5.8	3.4
304	1991.41	R15	F	fv	7.3	6.5	4.2	6.5	5.8	3.3
305	1991.42	R16	M	f	7.3	6.4	4.2	7.0	5.8	3.5
306	1991.65	R44	F	f	7.2	6.7	3.9	7.3	5.7	3.8
307	1991.45	R19	F	f	7.9	6.7	3.8	7.0	5.8	3.1
308	2001.151	LL80	F	f	7.8	7.1	4.3	7.2	6.0	2.8
309	2001.148	LL77	F	f	7.4	6.3	4.1	7.3	5.9	3.6
310	2001.146	LL75	M	f	8.0	6.8	4.1	7.5	6.3	3.7
311	2001.145	LL74	M	f	7.4	6.2	4.0	7.0	5.6	3.4
312	2001.171	LL100	F	f	6.9	5.9	3.7	6.9	5.3	2.9
313	2001.165	LL94	M	f	7.9	7.1	4.4	7.3	6.7	3.4
314	2001.150	LL79	F	f	7.5	6.4	3.7	6.8	5.9	2.9
315	2001.168	LL97	F	f	8.3	7.0	4.7	7.8	6.3	3.9
316	2001.170	LL99	F	f	7.9	7.4	4.4	7.3	5.9	3.7
317	2001.169	LL98	M	f	7.3	6.6	3.8	6.9	6.4	3.2
318	2001.158	LL87	M	fv	7.5	6.2	3.5	6.4	5.3	3.2
319	2001.149	LL78	F	f	7.7	6.5	4.1	6.8	6.0	3.4
320	2001.144	LL73	M	f	7.1	6.5	3.9	6.9	5.7	3.3
321	2001.143	LL72	M	f	7.5	6.3	3.8	7.2	5.9	3.7
322	2001.142	LL71	M	f	7.1	6.6	3.8	7.0	5.9	3.1
323	1991.68	R47	F	fv	7.3	6.5	3.7	7.0	5.4	3.1
324	1991.50	R25	F	f	7.6	6.4	3.6	6.7	5.6	3.6
325	1991.37	R8	M	fv	7.4	6.3	3.5	6.8	5.9	3.5
326	1991.64	R43	F	f	7.3	6.4	3.8	7.2	5.4	3.4
327	1991.44	R18	F	f	7.6	6.3	3.9	7.1	5.8	3.1
328	1991.35	R5	M	fv	7.4	6.4	4.1	7.2	5.8	3.3
329	1991.63	R42	M	f	7.8	6.6	4.2	7.6	6.2	3.7
330	1991.55	R32	F	fv	7.3	6.5	4.1	7.1	5.6	3.3

331	1991.66	R45	F	fv	6.6	5.9	3.8	6.8	5.4	2.8
332	1991.43	R17	F	fv	7.6	7.1	3.9	7.2	6.2	2.9
333	1991.49	R24	M	fv	6.9	5.7	3.6	6.5	5.3	3.0
334	1991.36	R7	M	fv	7.6	7.2	3.9	6.6	5.6	3.6
335	1991.39	R12	M	f	7.5	6.5	3.8	6.9	5.6	3.1
336	1991.38	R10	M	fv	7.7	6.9	4.3	7.5	6.0	3.7
337	1991.52	R29	F	f	7.3	6.4	3.7	6.6	5.9	3.0
338	1991.51	R27	M	f	7.3	6.2	3.8	6.5	5.5	3.0
339	1991.67	R46	M	f	7.7	6.8	3.8	7.4	6.1	3.4
340	2001.155	LL84	M	f	7.2	6.4	3.8	7.3	6.0	3.0

Miranda de Arga:

No.	MNHN ref.	Callou ref.	Sex	Fusion	F1	F	E	J	H	I
262	2001.91	MI4	M	f	8.2	7.0	4.1	7.4	6.5	3.2

Peralta:

No.	MNHN ref.	Callou ref.	Sex	Fusion	F1	F	E	J	H	I
221	2001.58	PE4	M	u	7.2	6.4	4.4	7.0	5.6	3.0
222	2001.64	PE10	F	fv	7.3	6.5	4.2	7.3	6.3	3.2
223	2001.66	PE12	M	f	7.4	7.1	3.9	7.1	6.0	3.5
224	2001.77	PE23	F	f	7.7	6.9	4.0	7.2	6.3	3.2
225	2001.55	PE1	F	fv	7.6	6.5	3.6	7.1	6.1	3.0
226	2001.59	PE5	F	fv	7.4	6.9	4.2	7.7	6.2	2.9
227	2001.75	PE21/27	F	f	7.5	7.3	4.5	7.6	6.2	3.3
228	2001.67	PE13	M	f	7.9	7.0	3.9	7.7	6.6	3.1
229	2001.68	PE14	M	f	8.0	7.2	4.1	8.1	6.7	3.5
230	2001.81	PE27/21	M	f	7.7	6.9	4.0	7.3	6.6	3.3
231	2001.74	PE20	M	f	7.2	6.9	3.8	7.5	6.2	2.9
232	2001.72	PE18	F	u	7.1	5.9	3.7	7.2	5.8	3.1
233	2001.60	PE6	M	f	8.1	7.3	4.5	7.6	6.7	3.8
234	2001.80	PE26	M	u	7.9	7.2	4.1	7.8	6.6	3.3
235	2001.63	PE9	F	u	6.9	6.2	3.5	7.0	5.7	3.1
236	2001.61	PE7	F	fv	7.7	6.8	3.9	7.3	6.2	3.3
237	2001.78	PE24	F	u	7.3	7.0	3.9	7.7	6.6	3.2
238	2001.71	PE17	M	fv	7.9	7.4	3.8	7.7	6.7	3.2
239	2001.65	PE11	F	u	6.9	5.9	3.2	6.8	5.6	2.5
240	2001.70	PE16	F	f	8.0	6.9	4.2	8.1	6.7	3.7
242	2001.69	PE15	M	f	7.2	6.6	4.0	7.1	6.0	3.2
243	2001.57	PE3	M	fv	7.9	6.7	4.3	7.6	6.2	3.4
244	2001.56	PE2	M	f	8.4	7.5	4.3	7.8	6.5	3.4
245	2001.62	PE8	F	f	8.4	7.5	4.0	7.7	6.8	3.7
246	2001.73	PE19	M	fv	7.8	7.1	4.5	7.5	6.5	3.0
247	2001.76	PE22	M	u	7.2	6.3	3.6	6.7	6.1	3.1

Ribaforada:

No.	MNHN ref.	Callou ref.	Sex	Fusion	F1	F	E	J	H	I
263	2001.118	RI1	M	f	7.7	7.4	3.8	7.1	6.6	3.0
265	2001.120	RI3	M	f	7.7	7.2	4.2	8.3	6.7	3.8
267	2001.122	RI5	F	f	7.2	6.9	4.0	7.7	6.5	3.3

Roissy:

No.	MNHN ref.	Callou ref.	Sex	Fusion	F1	F	E	J	H	I
82	2001.33	RO32	M	u	7.4	6.8	4.3	7.6	6.5	3.6
83	2001.50	RO52	M	f	7.7	7.2	4.2	8.3	6.7	3.4
84	2001.40	RO42	M	f	8.0	7.6	4.3	8.3	6.7	3.5
85	2001.39	RO41	M	f	7.9	7.6	5.1	8.6	7.2	3.8
86	2001.45	RO47	M	f	8.2	7.4	4.3	7.8	7.2	3.7
87	2001.23	RO22	M	u	8.4	7.5	4.6	7.9	7.0	3.8
88	2001.32	RO31	M	u	8.2	7.5	4.5	7.5	6.7	3.6
89	2001.47	RO49	M	f	8.1	7.4	5.1	8.1	7.3	3.7
90	2001.49	RO51	M	f	8.1	8.0	5.0	8.0	7.0	3.5
179	2001.3	RO2	-	f	7.7	8.1	4.8	7.6	6.5	3.5
180	2001.4	RO3	-	u	8.0	7.1	4.8	7.8	7.0	3.4
181	2001.5	RO4	-	u	7.5	7.3	4.7	8.0	6.8	3.5
182	2001.6	RO5	-	f	8.0	8.0	4.9	7.9	7.3	4.0
183	2001.8	RO7	-	u	8.4	8.5	5.2	8.1	7.8	3.9
184	2001.9	RO8	-	f	8.3	8.2	4.4	7.3	6.9	3.3
185	2001.10	RO9	-	f	8.4	7.4	4.4	7.8	6.8	3.3
186	2001.11	RO10	-	u	8.1	7.6	5.0	8.0	7.5	3.4
187	2001.12	RO11	-	u	7.9	7.2	4.8	7.9	7.0	3.8
188	2001.13	RO12	-	f	7.5	7.2	4.5	8.0	6.6	3.1
189	2001.14	RO13	-	f	8.7	7.4	4.5	8.0	7.0	3.3
190	2001.15	RO14	-	u	7.7	6.9	4.2	7.6	6.8	3.3
191	2001.16	RO15	M	f	7.6	7.4	4.3	7.8	7.1	3.8
192	2001.17	RO16	M	f	8.4	7.7	4.9	7.8	7.5	3.6
193	2001.18	RO17	M	f	7.7	7.3	4.6	7.7	6.7	3.6
194	2001.19	RO18	F	f	7.8	7.5	4.7	7.6	7.0	3.7
195	2001.20	RO19	F	u	7.9	7.2	4.5	7.9	6.6	3.4
196	2001.21	RO20	F	u	7.3	6.5	4.3	7.8	6.5	3.4
197	2001.24	RO23	F	f	7.9	7.3	4.4	7.8	6.3	3.3
198	2001.25	RO24	M	u	8.2	6.9	4.5	7.7	6.4	3.6
199	2001.26	RO25	F	fv	7.9	7.7	4.6	8.3	7.0	3.5
200	2001.46	RO48	F	f	7.8	7.2	5.1	8.4	6.7	3.2
201	2001.51	RO53	M	f	8.4	7.6	4.5	8.1	7.1	3.6
204	2001.2	RO1	-	u	7.5	6.8	4.6	7.6	6.6	3.3
205	2001.7	RO6	-	f	8.2	7.8	4.4	8.3	7.0	3.6
206	2001.22	RO21	F	f	8.1	7.7	4.6	8.4	7.0	3.5
207	2001.35	RO34	F	u	7.8	7.2	4.2	7.9	7.0	3.4
208	2001.43	RO45	F	f	7.9	7.5	4.2	8.0	7.2	3.5

209	2001.27	RO26	F	fv	7.5	7.1	4.6	7.4	6.4	3.4
210	2001.28	RO27	F	u	8.0	7.1	4.2	7.8	7.0	3.5
211	2001.42	RO44	M	fv	8.0	7.4	4.5	7.8	6.7	3.6
212	2001.52	RO54	F	f	7.9	7.4	4.9	7.9	6.8	3.1
213	2001.44	RO46	F	f	7.9	7.4	4.9	7.9	7.0	3.4
214	2001.36	RO35	F	fv	7.6	7.4	4.3	7.8	7.0	3.5
215	2001.37	RO36	F	f	7.5	7.0	4.2	7.9	6.6	3.3
216	2001.29	RO28	M	f	9.1	7.8	4.6	8.3	6.8	3.7
217	2001.34	RO33	F	f	8.2	7.4	4.5	7.9	6.7	3.3
218	2001.30	RO29	F	u	8.2	7.3	4.3	8.2	6.9	3.7
219	2001.31	RO30	F	f	7.5	7.3	4.1	7.5	6.8	3.2
220	2001.41	RO43	F	f	7.4	6.7	4.3	7.6	6.7	3.2
490	2001.48	RO50	F	f	7.8	7.2	4.4	8.2	6.8	3.4

Santarém:

No.	MNHN ref.	Callou ref.	Sex	Fusion	F1	F	E	J	H	I
30	1995.45	SM31	M	u	7.1	6.0	3.6	6.8	5.7	3.0
32	1995.45	SM31	M	u	6.5	5.5	4.0	6.6	5.2	2.6
34	1995.62	SM48	F	u	7.1	5.7	4.0	5.9	5.1	2.9
35	1995.53	SM39	F	u	6.6	6.1	3.3	6.9	5.8	3.1
37	1995.40	SM26	M	u	7.4	5.9	3.4	6.6	5.5	2.8
38	1995.33	SM19	F	u	7.2	6.0	3.4	6.6	5.5	2.8
42	1995.49	SM35	M	u	6.8	5.6	3.6	6.2	5.5	2.9
43	1995.63	SM49	M	u	7.7	6.5	4.1	7.2	5.9	3.3
44	1995.65	SM51	M	u	6.7	5.5	2.9	6.1	5.2	2.6
46	1995.59	SM45	F	u	6.9	6.0	4.1	6.4	5.3	3.3
47	1995.41	SM27	F	u	7.2	5.9	4.0	6.6	5.6	3.0
48	1995.34	SM20	M	u	7.4	5.7	3.8	6.5	5.6	2.9
52	1995.56	SM42	M	u	7.3	5.7	3.2	7.0	5.1	2.8
53	1995.61	SM47	M	u	6.9	5.9	3.3	6.6	5.4	2.7
54	1995.70	SM56	M	u	7.1	6.1	3.6	6.9	5.9	2.6
55	1995.42	SM28	M	u	7.0	6.1	4.0	6.9	5.7	2.9
56	1995.35	SM21	M	u	7.0	5.9	3.3	6.8	5.6	3.0
65	1995.30	SM16	M	f	7.4	6.3	3.7	7.1	5.7	3.0
66	1995.83	SM69	F	f	7.2	6.3	3.7	6.6	5.3	3.2
67	1995.15	SM1	F	f	7.2	6.1	3.7	7.7	6.1	2.8
68	1995.72	SM58	M	f	8.1	6.9	3.9	7.3	6.2	3.1
69	1995.66	SM52	M	f	7.9	7.1	4.3	7.9	6.1	3.4
70	1995.64	SM50	F	f	7.5	6.0	3.6	6.8	5.8	3.2
71	1995.60	SM46	M	f	7.1	6.6	3.9	7.1	6.2	2.9
72	1995.54	SM40	F	f	7.6	6.4	3.5	7.1	6.0	3.3
73	1995.46	SM32	M	f	7.2	6.1	3.2	6.9	5.5	3.3
360	1995.76	SM62	F	f	6.9	6.0	3.7	7.0	5.7	3.1
362	1995.29	SM15	F	f	7.3	6.4	3.4	6.8	5.9	3.0
364	1995.68	SM54	F	f	7.7	6.7	3.8	7.5	6.0	3.3
368	1995.24	SM10	M	f	7.4	6.0	3.4	6.7	5.6	2.9

378	1995.22	SM8	F	f	7.0	6.1	3.3	6.6	5.2	2.9
379	1995.23	SM9	F	f	7.4	6.6	3.8	7.4	5.9	2.8
380	1995.77	SM63	F	f	7.0	6.3	3.5	6.9	5.8	2.9
381	1995.21	SM7	F	f	7.3	6.3	3.7	6.7	5.6	2.8
382	1995.71	SM57	M	fv	7.5	6.0	3.5	7.0	5.2	3.0
383	1995.67	SM53	M	f	7.0	6.2	3.5	6.7	5.7	3.1
384	1995.75	SM61	M	f	7.1	6.3	3.7	6.8	5.7	3.2
385	1995.20	SM6	M	f	7.3	5.9	3.6	6.8	5.6	3.1
386	1995.74	SM60	F	f	7.1	6.4	3.4	6.8	5.9	2.7
387	1995.73	SM59	M	f	7.4	6.5	3.4	7.1	5.7	2.8
388	1995.69	SM55	F	f	8.0	6.4	4.1	6.9	6.1	2.9
468	1995.79	SM65	M	f	6.5	5.8	3.3	6.6	5.7	3.0
469	1995.87	SM73	M	f	7.2	6.5	3.6	6.9	5.6	3.1
470	1995.82	SM68	F	f	7.2	6.7	4.1	7.2	5.5	3.5
471	1995.37	SM23	F	f	7.5	6.2	3.6	7.3	5.8	3.0
472	1995.38	SM24	M	f	7.3	6.3	3.5	7.1	5.6	3.0
473	1995.85	SM71	M	f	7.1	6.3	3.6	7.2	6.0	3.2
474	1995.78	SM64	F	f	6.8	6.3	3.6	6.4	5.5	2.5
475	1995.25	SM11	F	f	7.7	6.7	3.9	7.2	6.1	3.1
476	1995.43	SM29	F	f	7.1	6.2	3.5	6.5	5.5	2.9
477	1995.44	SM30	F	f	7.3	6.3	3.3	6.7	5.3	3.4
478	1995.27	SM13	M	f	7.0	6.2	4.0	6.9	6.0	3.4
479	1995.19	SM5	F	f	6.4	5.9	3.4	6.8	5.3	2.7
480	1995.84	SM70	F	f	7.6	6.5	4.2	6.9	5.8	3.4
481	1995.86	SM72	M	f	7.3	6.1	3.5	6.6	5.3	3.2
482	1995.80	SM66	F	f	7.4	6.4	3.7	7.2	5.7	2.8
483	1995.81	SM67	M	f	7.7	6.3	3.7	6.5	5.9	3.1
484	1995.28	SM14	F	f	6.5	6.3	3.9	6.6	5.5	3.2
485	1995.16	SM2	M	f	7.4	6.7	3.7	7.5	5.8	3.4
486	1995.17	SM3	F	f	7.2	6.4	3.6	7.0	5.7	3.1
487	1995.26	SM12	M	f	8.4	7.2	4.0	6.8	5.8	3.2
488	1995.88	SM74	M	f	7.5	6.4	3.6	7.1	5.8	3.3
489	1995.18	SM4	F	f	7.1	6.5	3.6	6.7	5.8	2.8

Sesma:

No.	MNHN ref.	Callou ref.	Sex	Fusion	F1	F	E	J	H	I
279	2001.132	SE	-	f	8.1	7.3	4.0	8.2	6.6	3.3

Tudela:

No.	MNHN ref.	Callou ref.	Sex	Fusion	F1	F	E	J	H	I
351	2001.106	TU13	F	f	7.8	6.9	4.1	7.6	5.8	3.3
352	2001.110	TU17	F	f	8.1	6.9	4.6	8.0	6.6	3.3
353	2001.115	TU22	F	f	8.1	6.9	4.4	8.1	6.1	3.0
354	2001.117	TU24	M	f	7.8	7.0	4.2	7.4	6.0	3.1

355	2001.95	TU2	-	f	7.3	6.6	4.1	7.9	6.4	3.0
356	2001.111	TU18	F	f	7.2	6.5	4.0	7.1	5.5	3.1
357	2001.113	TU20	F	f	7.7	6.7	4.4	7.9	5.7	3.1
358	2001.116	TU23	F	f	7.6	6.5	4.1	7.2	6.3	3.2
359	2001.107	TU14	F	f	7.5	6.9	4.1	8.0	6.0	3.1
453	2001.100	TU7	-	u	7.1	6.5	4.0	7.3	5.8	3.6
454	2001.114	TU21-19	F	f	7.3	6.6	3.7	7.6	5.6	2.9
455	2001.97	TU4	-	f	7.6	6.5	3.9	7.2	5.4	2.9
456	2001.96	TU3	-	f	7.7	6.9	4.0	7.9	6.1	3.6
457	2001.94	TU1	-	f	7.5	6.4	3.7	7.5	5.7	3.1
458	2001.104	TU11	-	f	8.1	7.3	4.1	7.9	5.9	3.7
459	2001.102	TU9	-	f	7.8	7.1	4.2	7.9	6.0	3.3
460	2001.112	TU19-21	F	f	7.4	6.6	3.9	7.5	5.7	3.2
461	2001.105	TU12	-	u	6.8	6.1	3.7	6.6	5.0	2.9
462	2001.109	TU16-15	M	f	8.3	7.1	4.2	7.4	6.1	3.6
463	2001.103	TU10	-	f	7.8	7.3	4.3	8.2	6.6	3.6
464	2001.99	TU6	-	u	7.5	7.0	4.3	7.3	5.4	3.3
465	2001.101	TU8	-	f	8.4	7.2	3.9	8.2	6.0	3.5
466	2001.98	TU5	-	f	8.5	7.5	4.5	8.2	6.3	3.8
467	2001.108	TU15-16	M	f	7.9	6.6	4.4	7.5	6.2	3.2

Tour du Valat:

No.	MNHN ref.	Callou ref.	Sex	Fusion	F1	F	E	J	H	I
74	1991.73	C4	M	f	7.7	7.2	4.3	7.9	6.7	3.3
75	1991.74	C7	M	f	7.1	6.7	3.9	7.9	6.0	3.3
76	1991.70	C9	M	f	7.4	6.6	4.2	7.4	6.4	3.2
78	1991.75	C11	F	f	7.5	6.6	3.9	7.5	6.2	3.0
79	1991.71	C17	F	f	7.3	6.6	3.9	7.5	6.6	2.9
80	1991.77	C15	F	f	7.3	7.0	4.4	7.7	6.6	3.0
81	1991.72	C18	F	f	7.9	6.6	4.0	7.4	6.2	2.5
135	1991.80	C14	M	f	7.1	7.0	3.9	8.1	6.7	3.1
136	2001.92	C29	-	f	7.2	6.2	3.6	6.9	5.6	3.2
137	2001.82	C12	F	f	7.8	7.6	4.4	8.0	6.2	3.1
138	2001.79	C1	F	f	7.9	7.6	4.6	8.5	7.0	3.7
139	2001.87	C10	-	f	7.3	6.5	4.0	7.6	6.4	3.2
140	2001.81	C16	M	f	7.2	6.6	3.7	7.2	6.2	3.1
141	2001.90	C27	-	f	7.2	6.5	4.0	7.2	5.7	3.1
142	2001.85	C6	M	f	7.8	7.3	4.4	7.9	7.1	3.2
143	2001.86	C13	M	f	7.3	6.5	4.0	7.5	6.2	2.8
144	2001.84	C5	F	f	7.2	7.1	3.9	7.7	6.6	2.9
145	2001.83	C2	F	f	6.9	6.8	4.1	7.7	6.4	3.5
202	2001.89	C26	-	u	6.5	5.5	3.3	6.6	5.1	2.6

Versailles:

No.	MNHN ref.	Callou ref.	Sex	Fusion	F1	F	E	J	H	I
93	2001.208	V21	F	f	7.5	7.3	4.3	7.6	6.4	3.5
94	2001.209	V22	M	f	8.0	7.7	4.3	8.1	6.9	3.4
95	2001.204	V17	F	f	7.7	7.1	4.4	7.9	6.6	3.4
96	2001.194	V7	M	f	8.1	7.4	4.3	7.7	6.9	3.7
97	2001.199	V12	F	f	7.8	7.1	4.4	7.5	6.6	3.5
98	2001.198	V11	M	f	7.1	6.7	4.3	7.4	6.2	3.2
99	2001.203	V16	F	f	7.8	7.0	4.9	7.5	6.8	3.4
100	2001.210	V23	M	f	7.6	7.1	4.4	7.7	6.3	3.2
101	2001.200	V13	F	f	7.6	6.9	4.2	7.4	6.2	3.5
102	2001.205	V18	F	f	7.7	7.1	4.8	7.2	6.1	3.3
103	2001.195	V8	F	f	8.1	7.2	4.6	7.6	6.6	3.4
104	2001.188	V1	-	f	8.5	7.4	4.3	8.0	6.9	3.5
105	2001.191	V4	F	f	8.2	7.9	4.5	7.6	7.0	3.5
107	2001.193	V6	F	f	8.2	7.5	4.9	7.9	6.6	3.3
108	2001.207	V20	M	f	8.1	7.5	5.1	8.0	7.0	3.9
109	2001.197	V10	F	f	7.7	7.3	4.5	7.3	6.6	3.3
110	2001.202	V15	F	f	8.3	7.0	4.7	7.6	6.4	3.5
111	2001.212	V25	F	f	8.3	7.7	4.9	8.2	7.0	3.5
112	2001.189	V2	-	u	7.1	6.8	4.2	6.9	6.3	3.5
113	2001.192	V5	F	f	7.6	6.8	4.4	7.5	6.6	3.5
114	2001.196	V9	M	f	8.0	7.5	4.8	7.6	7.1	3.5
116	2001.211	V24	F	f	8.3	7.1	4.5	7.9	7.0	3.4
117	2001.201	V14	M	f	7.8	7.3	4.6	7.8	7.1	3.2

Vila Viçosa:

No.	MNHN ref.	Callou ref.	Sex	Fusion	F1	F	E	J	H	I
1	1995.134	VV46	F	u	7.6	6.5	3.6	7.0	5.4	3.0
2	1995.99	VV11	F	f	7.7	7.2	3.8	7.5	6.2	3.1
3	1995.129	VV41	M	fv	6.8	5.9	4.0	6.9	5.6	3.1
4	1995.138	VV50	M	f	7.1	6.0	3.8	6.8	5.6	3.4
5	1995.97	VV9	F	f	7.0	6.7	3.5	7.2	5.5	3.3
6	1995.125	VV37	F	f	6.7	6.4	3.5	6.8	5.8	2.9
7	1995.139	VV51	F	f	7.6	6.4	3.8	7.3	5.8	3.3
8	1995.115	VV27	M	f	7.1	6.4	3.9	7.1	5.8	3.3
9	1995.136	VV48	F	f	7.4	6.7	3.7	7.4	6.0	3.1
10	1995.90	VV2	F	f	7.1	6.5	3.5	7.2	6.3	3.1
11	1995.100	VV12	M	f	7.0	6.1	3.3	6.9	5.6	2.7
12	1995.105	VV17	M	f	6.8	6.1	3.3	6.4	5.7	2.6
13	1995.126	VV38	F	f	6.9	6.4	3.4	6.9	5.7	3.3
14	1995.127	VV39	F	f	7.2	6.4	3.4	7.1	5.7	3.2
15	1995.140	VV52	M	f	7.6	6.9	3.7	7.3	5.8	3.5
16	1995.135	VV47	F	f	8.2	6.6	3.3	7.6	5.9	3.2
17	1995.114	VV26	F	f	7.5	7.1	4.0	6.7	5.9	3.4

18	1995.131	VV43	M	f	7.1	6.8	3.8	7.1	5.9	3.3
19	1995.91	VV3	F	f	7.0	6.6	3.5	7.0	5.8	2.9
20	1995.128	VV40	F	f	7.5	6.5	3.7	7.0	5.7	3.1
21	1995.124	VV36	F	u	7.2	6.8	3.8	7.0	5.9	3.3
22	1995.102	VV14	F	f	7.0	6.9	3.5	7.0	5.9	2.9
23	1995.132	VV44	F	f	7.8	7.2	3.6	7.1	5.9	3.2
24	1995.109	VV21	F	f	7.2	6.5	4.2	6.8	6.1	3.1
25	1995.137	VV49	M	f	7.3	6.2	3.9	7.1	5.6	3.5
26	1995.116	VV28	M	f	7.7	6.6	4.2	7.4	6.1	3.6
27	1995.141	VV53	F	f	7.3	6.4	3.6	7.1	5.7	3.2
49	1995.121	VV33	F	u	7.4	6.5	4.1	6.9	5.8	3.6
51	1995.108	VV20	F	u	6.9	6.2	3.6	6.7	5.7	3.0
57	1995.101	VV13	M	u	7.2	6.1	3.4	6.3	5.5	3.0
58	1995.123	VV35	F	u	7.3	6.2	3.6	7.1	5.8	3.5
60	1995.110	VV22	F	u	6.6	6.0	3.5	6.5	5.8	3.2
62	1995.111	VV23	M	u	6.9	6.3	3.6	6.4	5.3	3.2
361	1995.103	VV15	M	f	6.8	6.3	3.5	6.8	5.5	2.5
363	1995.120	VV32	F	f	6.6	5.8	3.9	7.2	5.9	2.9
365	1995.133	VV45	F	f	7.6	6.4	4.4	7.9	5.9	3.1
366	1995.119	VV31	M	f	7.4	6.8	4.0	7.9	6.1	3.2
367	1995.122	VV34	F	f	7.7	6.6	3.6	7.7	5.8	3.3
369	1995.94	VV6	M	f	7.2	6.9	3.6	7.1	6.2	3.2
370	1995.89	VV1	M	f	7.4	6.5	3.8	7.1	5.6	3.3
371	1995.130	VV42	F	fv	7.1	6.6	3.9	7.1	6.1	3.6
372	1995.117	VV29	F	f	7.2	6.6	3.4	7.5	5.8	2.8
373	1995.93	VV5	F	f	7.5	6.8	3.7	7.1	5.4	3.3
374	1995.113	VV25	F	f	7.7	6.9	3.8	7.3	6.0	3.3
375	1995.98	VV10	M	f	6.8	6.3	3.8	6.6	5.8	3.4
376	1995.104	VV16	M	f	7.6	6.7	3.9	7.4	5.7	2.8
377	1995.96	VV8	F	f	6.8	6.0	3.4	6.9	5.5	2.9

Zembra:

No.	MNHN ref.	Callou ref.	Sex	Fusion	F1	F	E	J	H	I
148	1991.9	ZA9	-	f	7.4	6.4	3.6	7.2	5.4	3.1
149	1991.5	ZA5	-	f	7.8	7.0	3.9	7.3	6.3	3.0
151	1991.3	ZA3	-	f	8.0	7.1	3.8	7.0	6.1	3.3
152	1991.1	ZA1	-	f	7.5	6.8	4.2	7.5	6.0	3.2
156	1991.17	ZA17	-	f	7.6	6.7	3.7	7.4	5.9	2.5
157	1991.15	ZA15	-	f	7.7	7.2	4.1	7.9	6.3	3.5
158	1991.8	ZA8	-	f	7.5	7.0	4.4	7.3	5.9	3.0
160	1991.14	ZA14	-	f	7.6	6.6	3.7	7.0	6.1	2.7
165	1991.11	ZA11	-	f	8.1	6.7	3.9	6.8	6.1	3.2
166	1991.12	ZA12	-	f	7.0	6.2	3.8	6.7	5.5	3.3
169	1991.19	ZA19	-	f	6.4	6.2	3.6	6.7	5.5	3.0
174	1991.26	ZA26	-	f	7.2	6.5	3.9	6.5	5.6	2.8
175	1991.27	ZA27	-	f	8.0	7.0	4.3	7.7	6.6	3.0

176	1991.28	ZA28	-	f	7.5	6.9	3.9	7.2	6.1	3.3
178	1991.30	ZA30	-	f	7.7	6.6	3.7	7.1	6.0	3.3

Domestic (Papillon):

No.	MNHN ref.	Sex	Fusion	F1	F	E	J	H	I
940	2007-1560	F	-	10.0	9.2	6.6	9.9	8.8	4.2
941	2007-1559	M	-	9.6	8.7	6.5	9.7	7.9	4.3

Domestic (Gris de Vienne):

No.	MNHN ref.	Sex	Fusion	F1	F	E	J	H	I
942	2007-1561	M	-	11.2	10.1	7.5	11.6	10.1	4.6
943	2007-1562	M	-	11.0	10.2	6.5	11.1	9.8	5.0
944	2007-1565	M	-	10.7	9.6	6.0	10.4	9.5	4.4
945	2007-1563	M	-	9.7	8.3	5.8	8.8	8.1	4.1
947	2007-1564	F	f	10.9	9.8	6.4	9.7	8.9	4.6

Cova Matutano:

No.	Level	Phase	F1	F	E	J	H	I
3408	N4 97-113	C	8.9	7.7	4.1	7.7	6.2	3.6
3517	N7 165-171	B	8.6	7.1	3.8	8.0	6.2	3.2
3518	N7 165-171	B	7.4	6.4	3.5	6.7	6.3	3.0
3520	N7 165-171	B	8.2	7.0	4.0	8.0	6.0	3.6
3805	N8 201-208	A	9.0	7.3	4.5	7.6	6.7	3.7
3806	N8 201-208	A	8.8	7.8	4.3	8.4	6.8	3.9
3807	N8 201-208	A	8.4	7.5	4.1	8.2	6.4	3.8
3812	N8 201-208	A	7.9	7.3	4.1	7.4	6.2	3.6
3813	N8 201-208	A	8.6	7.1	4.1	7.5	6.4	3.6
3820	N8 201-208	A	8.2	7.1	3.9	7.7	6.3	3.9
3822	N8 201-208	A	8.4	7.0	4.2	7.6	6.2	3.6
3824	N8 201-208	A	9.4	7.7	4.5	8.4	6.9	3.1
3829	N8 201-208	A	8.8	7.5	4.5	8.0	6.6	3.6
3855	N8 201-208	A	8.3	7.4	4.2	7.7	6.3	3.6
3856	N8 201-208	A	8.2	7.2	3.9	8.0	6.4	3.6
3858	N8 201-208	A	8.7	7.3	4.2	8.0	6.5	3.9
3859	N8 201-208	A	8.9	7.6	4.3	8.4	7.0	3.6
3862	N8 201-208	A	7.7	7.0	4.1	7.9	6.1	3.1
3865	N8 201-208	A	8.3	7.2	3.9	7.4	6.5	3.8
4477	N3 77-97	C	7.9	7.7	4.0	8.2	6.9	3.7
4490	N3 77-97	C	8.2	6.9	3.8	7.4	6.2	3.1
4512	N3 77-97	C	9.4	7.8	4.5	8.8	7.4	3.5
4729	N1 48-68	D	8.7	7.7	4.2	7.9	6.7	3.5

4985	N7 177-187	B	8.3	7.1	4.0	7.5	6.6	3.1
4987	N7 177-187	B	8.0	7.3	4.1	8.2	6.1	3.3
4988	N7 177-187	B	8.3	7.3	4.1	7.9	6.0	3.7
4990	N7 177-187	B	8.6	7.3	4.2	8.0	6.8	3.7
5006	N7 177-187	B	8.8	8.0	4.3	8.6	6.9	3.5
5012	N7 177-187	B	8.6	7.1	3.8	8.5	6.4	3.1
5014	N7 177-187	B	8.2	7.3	4.2	7.8	6.5	3.5
5018	N7 177-187	B	7.8	6.6	3.4	7.0	5.9	3.3
5299	N5 133-155	C	7.8	6.9	3.9	7.3	5.9	3.2
5303	N5 133-155	C	9.0	7.9	4.5	8.9	6.6	3.6
5308	N5 133-155	C	9.0	7.8	4.6	7.9	7.1	3.3
5315	N5 133-155	C	8.0	6.9	3.8	7.5	6.2	3.7
5509	N4 113-133	C	8.5	7.0	5.0	8.0	6.9	3.7
5516	N4 113-133	C	8.7	7.1	4.3	8.0	6.5	3.6
5517	N4 113-133	C	8.2	7.3	4.2	8.0	6.3	3.2
5519	N4 113-133	C	7.6	7.0	4.0	7.7	6.2	3.3
5526	N4 113-133	C	7.5	7.3	4.0	8.5	6.5	3.4
5527	N4 113-133	C	7.3	5.8	3.5	6.8	5.3	2.4
5736	N6 153-162	B	7.5	7.0	3.5	7.0	6.0	3.0
5737	N6 153-162	B	8.4	7.5	4.3	9.0	6.6	3.7
5740	N6 153-162	B	7.9	6.8	3.9	7.5	6.1	3.2
5762	N6 153-162	B	8.4	7.6	4.1	8.3	6.8	3.4
5765	N6 153-162	B	8.2	7.5	4.1	7.7	6.7	3.4
5767	N6 153-162	B	8.0	7.2	4.1	7.8	6.1	3.6
5771	N6 153-162	B	7.7	6.8	3.3	7.2	6.0	3.5
6051	N7 171-177	B	9.1	7.6	4.5	8.6	6.8	3.8
6188	N2 68-77	D	7.8	6.8	4.0	7.5	6.3	3.5
6189	N2 68-77	D	8.1	7.1	4.0	7.9	6.7	3.3
6194	N2 68-77	D	7.5	6.8	3.7	7.3	6.3	3.4
6469	N8	A	8.3	7.2	4.6	8.0	6.7	3.7
6472	N8	A	7.5	7.1	3.6	7.4	6.3	3.1
6486	N8	A	7.8	7.4	4.3	7.9	6.4	3.0
6487	N8	A	9.0	8.0	4.4	8.6	7.0	3.2
6505	N8	A	8.8	7.8	4.0	8.2	6.9	3.6
6507	N8	A	8.0	6.7	3.9	7.2	6.1	3.2
6508	N8	A	8.0	6.9	4.2	7.6	6.5	3.6
6514	N8	A	9.1	7.3	4.1	7.0	6.0	3.5
6517	N8	A	8.2	7.4	3.9	8.3	6.4	3.1
6530	N8	A	7.5	6.7	4.1	7.8	6.4	3.5
6531	N8	A	8.3	7.3	4.5	7.6	6.9	3.4
6532	N8	A	9.5	8.0	4.6	8.6	6.9	4.0
6535	N8	A	7.5	6.8	3.9	7.7	6.2	3.3
6536	N8	A	8.0	6.7	4.4	7.8	5.8	3.8
6742	NS 8-48	E	8.8	7.1	4.2	8.1	6.3	3.3
6747	NS 8-48	E	8.3	7.3	4.1	7.9	6.7	3.5
6754	NS 8-48	E	8.5	7.3	4.4	7.9	6.6	3.4
6755	NS 8-48	E	8.6	7.6	4.5	8.3	7.0	3.8

Beja:

No.	Site ref. no.	F1	F	E	J	H	I
495	Silo 65 65/84 XIV	8.4	6.7	4.3	7.7	6.4	3.1
497	Silo 65 65/84 XIV	8.3	7.4	4.2	7.7	6.3	3.6
498	Silo 65 65/84 XIV	7.9	6.8	3.7	6.9	6.0	3.6
499	Silo 65 65/84 XIV	8.3	6.8	3.7	7.2	6.2	3.1
500	Silo 65 65/84 XIV	6.7	6.3	3.5	6.4	5.1	2.8
501	Silo 65 65/84 XIV	7.3	6.2	3.9	6.9	5.5	3.6
502	Silo 65 65/84 XIV	7.1	5.9	3.6	6.3	5.2	3.3
503	Silo 65 65/84 XIV	7.8	6.9	4.0	7.1	5.9	3.3
504	Silo 65 65/84 XIV	7.5	6.5	3.8	7.1	6.1	3.3
505	Silo 65 65/84 XIV	7.6	6.5	3.9	7.0	5.7	3.4
507	Silo 65 65/84 XIV	6.8	6.1	3.5	6.5	5.3	3.3
508	Silo 65 65/84 XXI	7.7	6.1	3.2	6.8	5.6	3.0
509	Silo 65 65/84 XXI	7.1	6.0	3.9	6.5	5.5	3.0
514	Silo 80 80/114 XXVI	7.3	6.4	3.6	7.1	5.6	3.0
515	Silo 80 80/114 XXVI	7.3	6.1	3.4	6.8	5.2	2.8
516	Silo 80 80/116 XXXV	7.1	6.1	3.6	6.8	5.6	3.2
517	Silo 80 80/116 XXXV	7.9	6.6	3.6	7.2	5.8	3.3
518	Silo 80 80/116 XXXV	7.5	6.6	3.6	6.9	5.5	3.1
519	Silo 80 80/118 LI	7.9	7.1	4.0	7.3	6.1	3.9
520	Silo 80 80/118 LI	8.7	7.6	4.5	8.1	6.5	3.7
521	Silo 86 86/119 II	7.6	6.6	4.0	7.3	6.2	3.1
522	Silo 89 89/129 XVI	7.2	5.9	3.9	7.0	5.4	3.0
524	Silo 86 86/123 XL	8.1	7.2	4.0	7.3	6.4	3.3
527	Silo 86 86/120 XIV	7.9	7.0	3.9	7.6	5.8	3.4
528	Silo 86 86/126 L	7.1	6.4	3.5	7.1	5.9	3.3
529	Silo 86 86/126 L	8.1	7.4	4.5	7.6	6.8	3.4
530	Silo 128 128/175 XLVI	7.4	6.7	3.9	6.7	5.9	3.4
531	Silo 128 128/173 XXIX	7.6	6.5	3.8	6.8	5.7	3.0
532	Silo 128 128/173 XXIX	8.1	7.1	4.5	6.9	6.4	3.6
534	Silo 128 128/176 LII	7.5	6.5	3.7	6.9	5.9	3.1
535	Silo 128 128/176 LII	7.9	6.7	3.6	7.3	6.3	3.3
536	Silo 128 128/176 LII	7.5	6.5	4.3	7.0	5.5	2.9
537	Silo 128 128/176 LII	7.9	7.1	4.1	7.5	6.2	3.6
538	Silo 128 128/176 LII	7.6	6.3	3.5	7.0	5.9	3.1
539	Silo 128 128/176 LII	7.3	6.4	3.6	6.8	6.2	3.4
540	Silo 128 128/170 VI	8.7	7.0	4.2	8.1	6.6	3.6
541	Silo 128 128/170 VI	8.1	7.2	4.0	7.6	6.0	3.2
542	Silo 128 128/170 VI	7.3	6.2	3.7	7.0	5.9	3.5
543	Silo 128 128/170 VI	7.5	6.5	3.7	7.2	6.0	3.1
544	Silo 128 128/170 VI	7.2	6.2	3.6	7.0	5.6	2.9
545	Silo 128 128/172 XXII	7.5	7.1	3.9	7.4	6.3	3.0
546	Silo 128 128/172 XXII	7.8	7.1	3.8	7.0	6.5	3.4
547	Silo 128 128/172 XXII	7.7	6.5	4.1	6.7	5.7	3.2
549	Silo 128 128/172 XXII	8.2	7.0	3.9	7.1	5.6	3.2
550	Silo 128 128/172 XXII	7.8	7.1	4.1	7.6	6.4	3.0

Silves:

No.	Site ref. no.	F1	F	E	J	H	I
592	Quad-07 Est-8 Cam1032	7.1	6.5	3.7	7.0	5.7	2.9
593	Quad-L7 Est-5 Cam1034	7.5	6.5	3.8	6.8	5.3	3.2
594	Quad-J7 Est-5 Cam1039	7.4	6.9	4.0	7.4	6.0	3.0
595	Quad-O7 Est-7 Cam1050	7.4	6.6	3.2	6.6	5.5	2.9
598	Quad-M7 Est-8 Cam1034	7.7	6.2	3.7	7.2	6.1	3.3
599	Quad-N7 Est-11 Cam1031	7.0	6.1	3.5	6.6	5.4	2.8
600	Quad-N7 Est-10 Cam1030	6.9	6.5	3.7	6.7	5.5	3.0
601	Quad-K7 Est-6 Cam1043	7.3	6.5	3.8	7.0	5.6	2.9
602	Quad-L7 Est-5 Cam1034	7.9	6.4	3.5	7.1	5.9	3.0
603	Quad-L7 Est-5 Cam1034	7.5	6.7	3.8	7.0	5.8	3.3
604	Quad-L7 Est-5 Cam1034	7.7	6.6	4.0	7.2	6.2	3.0
605	Quad-M7 Est-4A Cam1034	7.9	6.9	3.6	7.3	5.9	3.3
606	Quad-M7 Est-4A Cam1034	7.7	6.6	3.8	7.4	5.9	3.3
607	Quad-M7 Est-8A Cam1034	7.1	6.3	3.5	7.6	5.7	3.0
608	Quad-L7 Est-5 Cam1034	7.4	6.6	4.0	7.3	5.8	3.0
609	Quad-K7 Est-6 Cam1043	7.4	6.5	3.6	6.6	5.6	3.1
610	Quad-N7 Est-7 Cam1050	7.0	6.2	3.3	6.2	5.5	3.1
611	Quad-M7 Est-4A Cam1034	7.3	6.2	3.5	6.7	6.3	3.1
612	Quad-M7 Est-8 Cam1034	7.4	6.0	3.7	7.1	5.7	3.0
613	Quad-M7 Est-8 Cam1034	7.9	6.5	3.6	6.9	5.6	2.6
614	Quad-M7 Est-8 Cam1034	7.1	6.3	3.8	6.5	5.5	2.9
615	Quad-M7 Est-8 Cam1034	6.9	6.2	3.3	6.5	5.4	2.8
616	Quad-M7 Est-8 Cam1034	7.6	6.5	3.7	7.1	6.1	3.3
617	Quad-M7 Est-6 Cam1036	7.2	6.7	3.7	7.2	5.8	3.2
618	Quad-O6 Est-5 Cam1036	7.3	6.5	4.0	7.1	5.7	3.6
619	Quad-L7 Est-4 Cam1035	7.9	6.4	3.4	6.9	5.6	2.8
620	Quad-N6 Est-5a1 Cam1034	7.1	6.6	3.7	6.9	5.9	2.9