



OATAO is an open access repository that collects the work of Toulouse researchers and makes it freely available over the web where possible

This is an author's version published in: <http://oatao.univ-toulouse.fr/20855>

**To cite this version:**

Durán Martínez, Freddy-Libardo<sup>ORCID</sup> and Julcour-Lebigue, Carine<sup>ORCID</sup> and Larachi, Faiçal and Alphonse, Pierre<sup>ORCID</sup> and Billet, Anne-Marie<sup>ORCID</sup> *Development of a reactor-heat exchanger of monolith type for three-phase hydrogenation reactions: proof of concept and modelling strategy.* (2017) In: 10th International Symposium on Catalysis in Multiphase Reactors & 9th International Symposium on Multifunctional Reactors (CAMURE 10 & ISMR 9), 7 July 2017 - 10 July 2017 (Qingdao, China). (Unpublished)

Any correspondence concerning this service should be sent to the repository administrator: [tech-oatao@listes-diff.inp-toulouse.fr](mailto:tech-oatao@listes-diff.inp-toulouse.fr)

# Development of a reactor-heat exchanger of monolith type for three-phase hydrogenation reactions: proof of concept and modelling strategy



Université  
de Toulouse



TOTAL

*F. L. Durán Martínez<sup>1</sup>, C. Julcour<sup>1</sup>, F. Larachi<sup>2</sup>, P. Alphonse<sup>3</sup>, A.M. Billet<sup>1</sup>*

<sup>1</sup> *Laboratoire de Génie Chimique, Université de Toulouse, CNRS, INPT, UPS, Toulouse, France;*

<sup>2</sup> *Université Laval, Chemical Engineering Dpt, Québec, Canada;*

<sup>3</sup> *CIRIMAT, Université de Toulouse, CNRS, INPT, UPS, Toulouse, France.*



International Symposiums on Catalysis in Multiphase Reactors and Multifunctional Reactors

2017.07.07-2017.07.10 Qingdao, China

# Motivation

Development of an innovative reactor for three-phase catalytic (fast, exothermic, selective ...) reactions

## Drawbacks of conventional three-phase reactors:

*Fixed bed reactor*

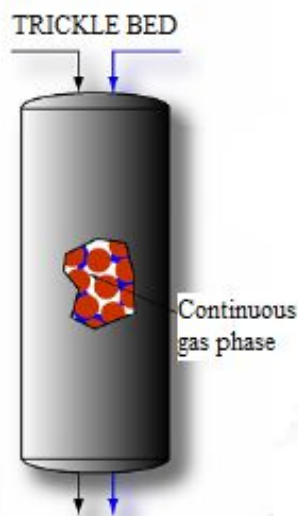

- Liquid maldistribution (TBR)
- Partial catalyst wetting (TBR)
- Prone to hot spots and runaway (TBR)
- High resistances to mass transfer
- Limitations of use for viscous/foaming fluids
- Plugging, high  $\Delta P$  for small beads

*Slurry reactor*

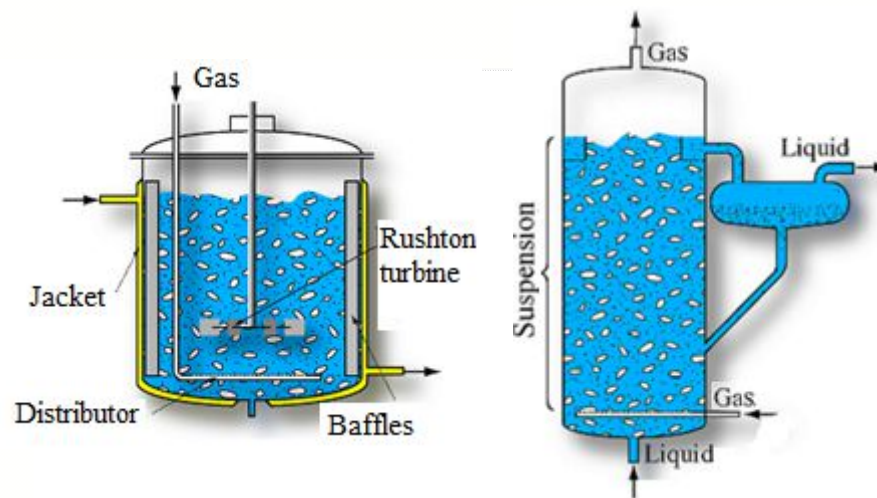

- Uneasy catalyst separation, attrition
- Lower productivity (low  $\varepsilon_s$ , high mixing)
- Promotion of homogeneous reactions
- High energy costs (mechanical stirring)



# Suggested technical solution

Development of an innovative reactor inspired from monolith technology and equipped with *in situ* heat removal system

HYDROMoRe project

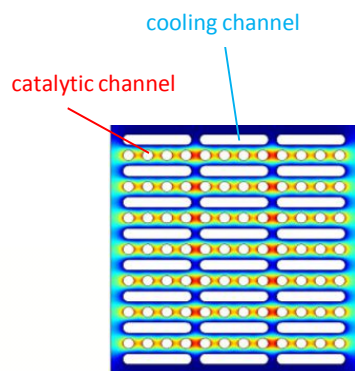

Catalytic channel walls:  
heat conductive scaffold

## Expected features:

- Low  $\Delta P$
- Low diffusional limitations (**thin catalytic layer**)
- Good G-L & L-S mass transfer (**Taylor Flow**)
- Plug flow in channels (**TF**,  $\uparrow$  productivity & selectivity)
- High heat removal (metal conductivity)
- Fast draining in case of runaway

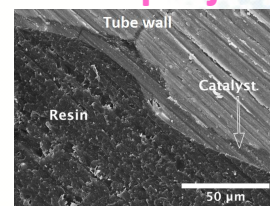

# Suggested technical solution

Development of an innovative reactor inspired from monolith technology and equipped with *in situ* heat removal system

HYDROMoRe project

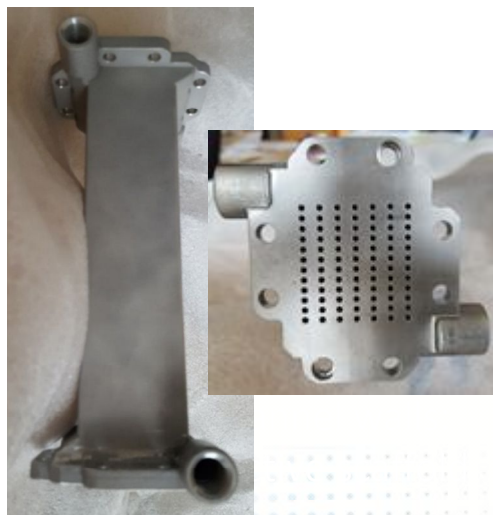

## Expected features:

- Low  $\Delta P$
- Low diffusional limitations (**thin catalytic layer**)
- Good G-L & L-S mass transfer (**Taylor Flow**)
- Plug flow in channels (**TF**,  $\uparrow$  productivity & selectivity)
- High heat removal (metal conductivity)
- Fast draining in case of runaway

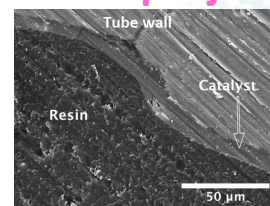

## Issues:

### - **Technology:**

- \* Proof of concept? **Manufacture by selective laser melting (Al alloy)**
- \* Catalyst coating & stability?
- \* Even G & L distribution in the channels?

### - **Modelling:**

- \* required degree of complexity for a sizing tool?
- \* relevant scales?



# Exp. & modelling strategy

## FLUID DISTRIBUTION ZONE

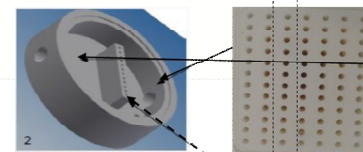
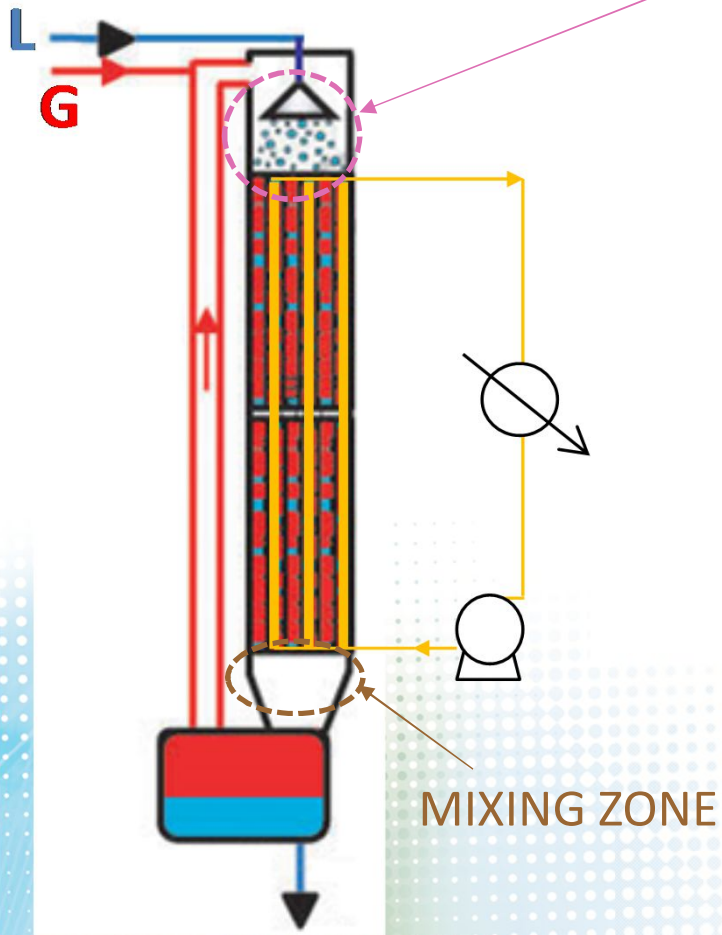

*Exp. characterization on cold mock-up (liquid collection & RTD)*

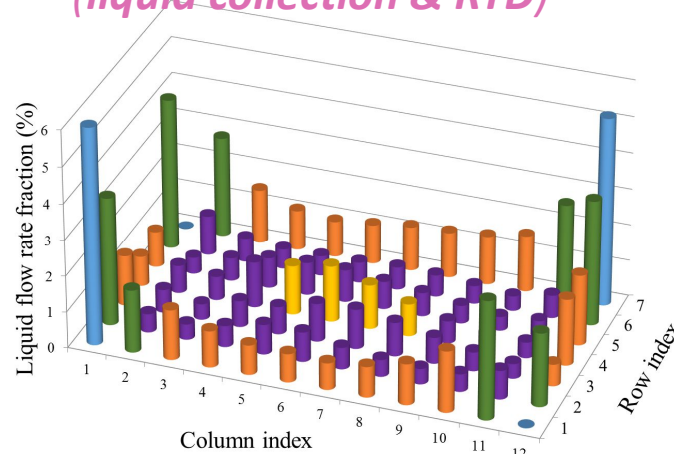

# Exp. & modelling strategy

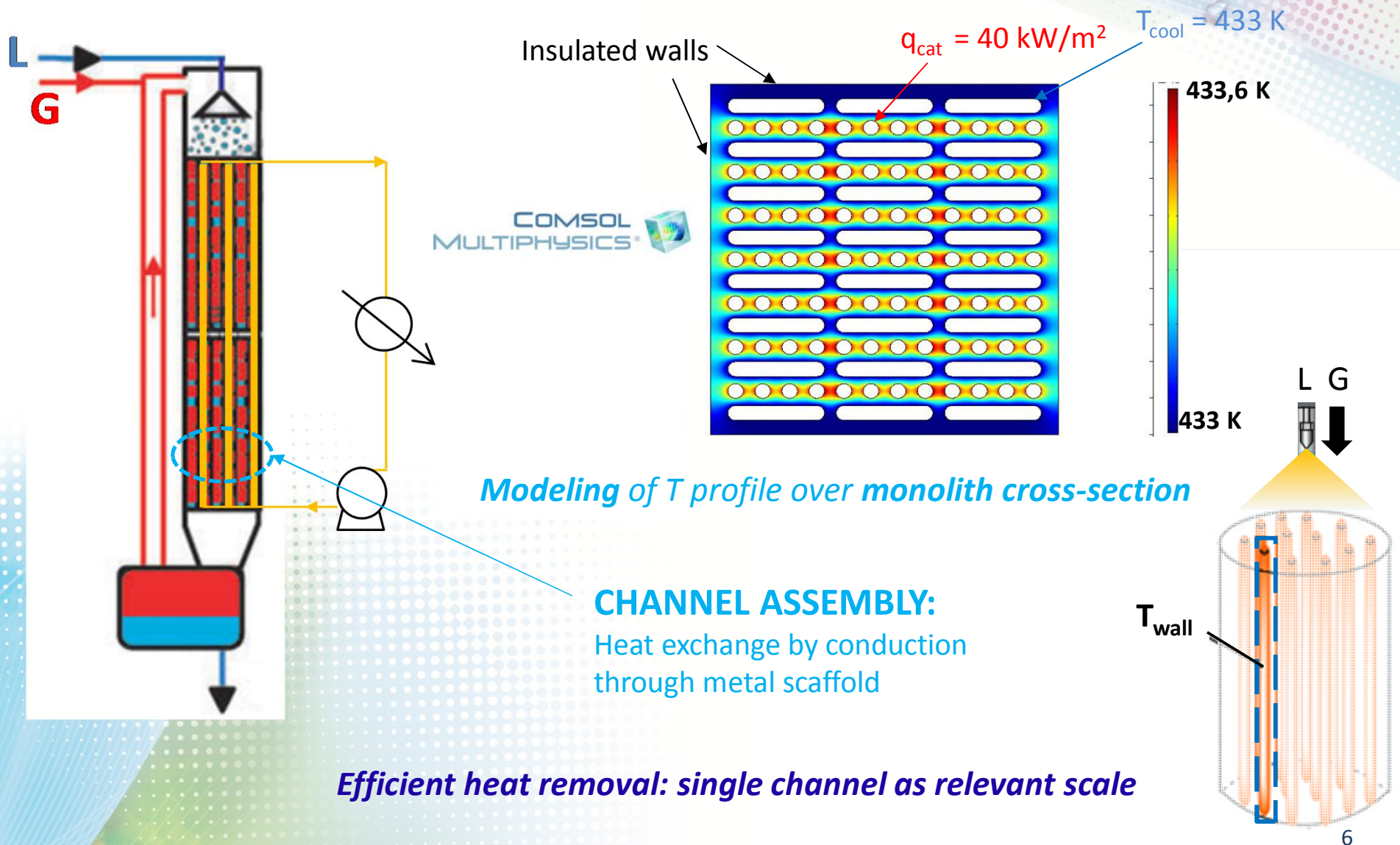



# Exp. & modelling strategy

Hydrodynamic regime?

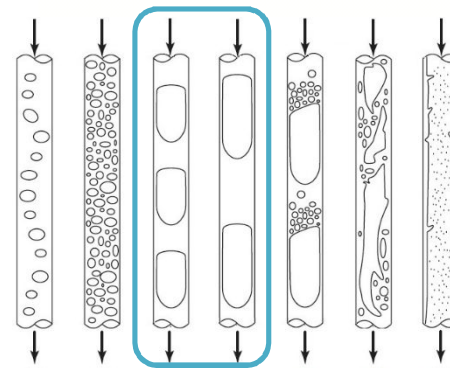
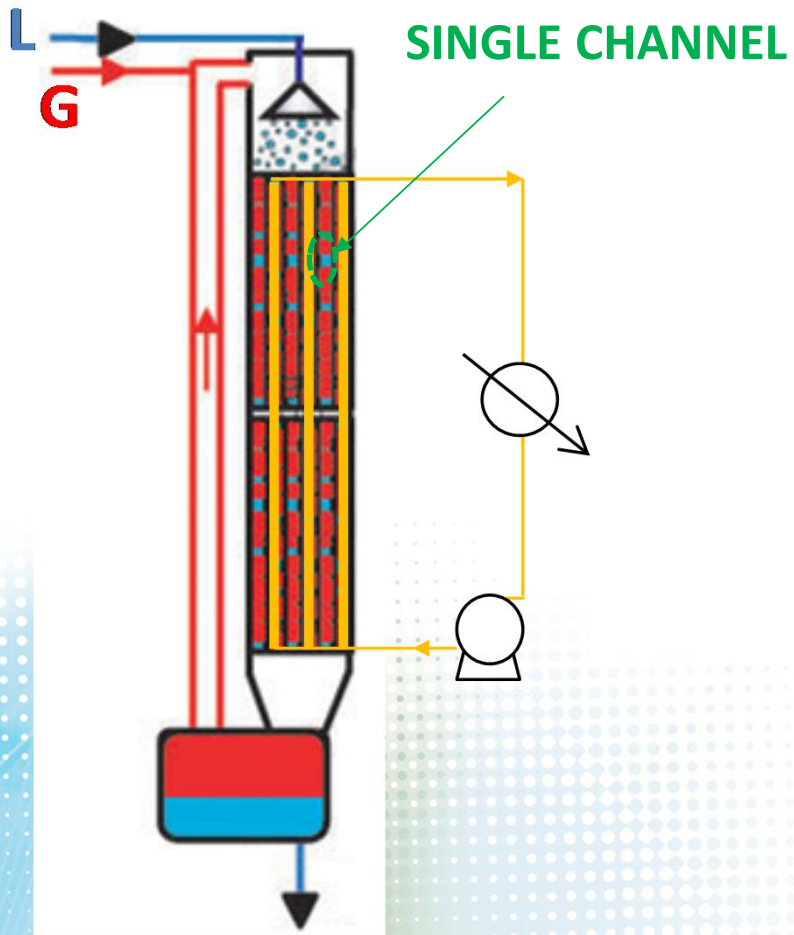



# Exp. & modelling strategy

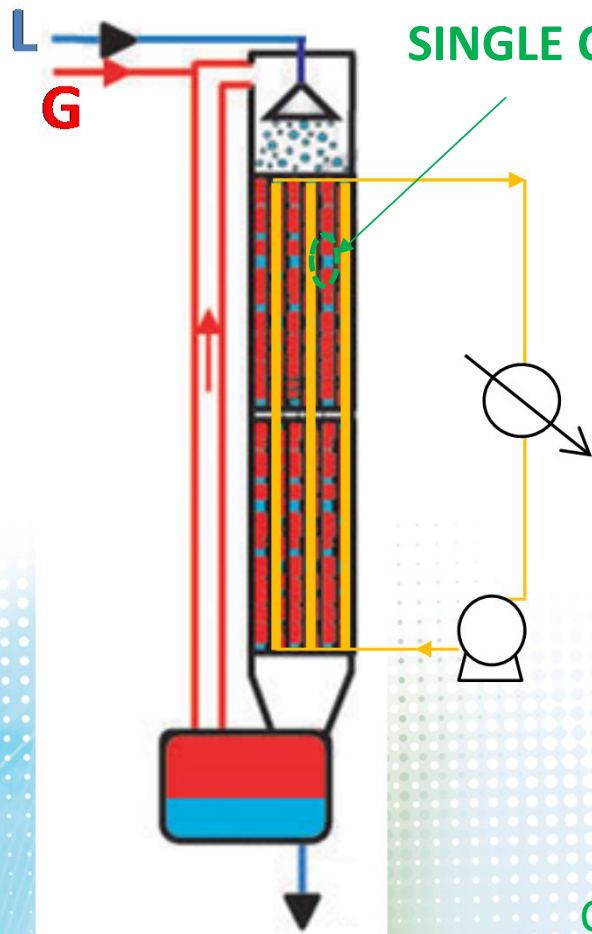

Hydrodynamic regime?

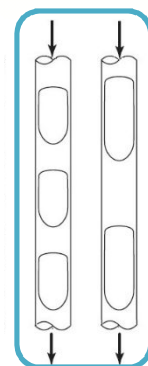

Taylor regime  
(fully developed flow)

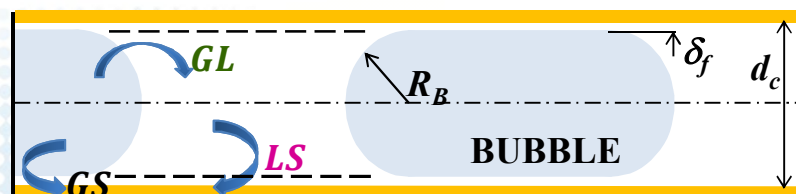

Complex interplay in between mass transfer,  
local hydrodynamics & catalytic reaction

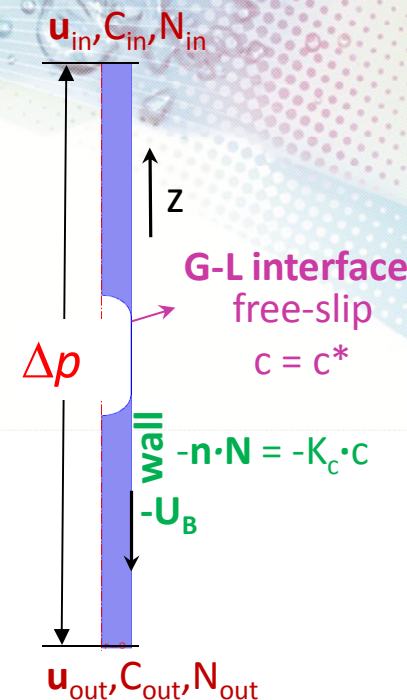

CFD modelling

# Model validation

“Theoretical”: absorption of O<sub>2</sub> in water  
(van Baten & Krishna, 2004)

$$N = \iint_{\Omega} -D \left( \frac{\partial c}{\partial z} \cdot n_z + \frac{\partial c}{\partial r} \cdot n_r \right) dS$$

$$[k_L a]_{abs} = \frac{N_{bubble}}{(c^* - c_{mean})} * \frac{1}{V_{UC}}$$

bubble  $c = c^*$   
 wall  $-n \cdot N = -K_c \cdot c$

$L_{UC} = 40 \text{ mm}$   
 $\delta_f = 48 \text{ }\mu\text{m}$   
 $U_B = 0.30 \text{ m/s}$   
 $\varepsilon_G = 0.17$

✓ higher  $k_L a$  value by up to 35% in short UC

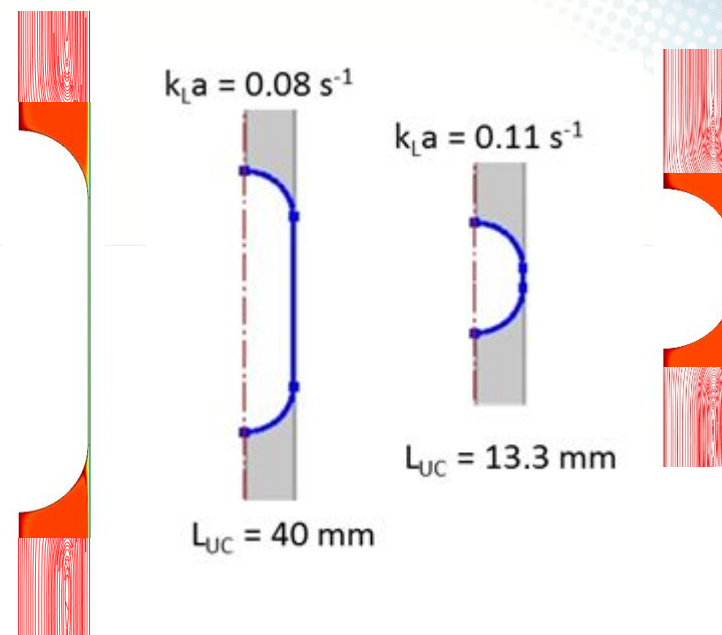



# Model validation

“Theoretical”: absorption of O<sub>2</sub> in water  
(van Baten & Krishna, 2004)

$$N = \iint_{\Omega} -D \left( \frac{\partial c}{\partial z} \cdot n_z + \frac{\partial c}{\partial r} \cdot n_r \right) dS$$

$$[k_L a]_{abs} = \frac{N_{bubble}}{(c^* - c_{mean})} * \frac{1}{V_{UC}}$$

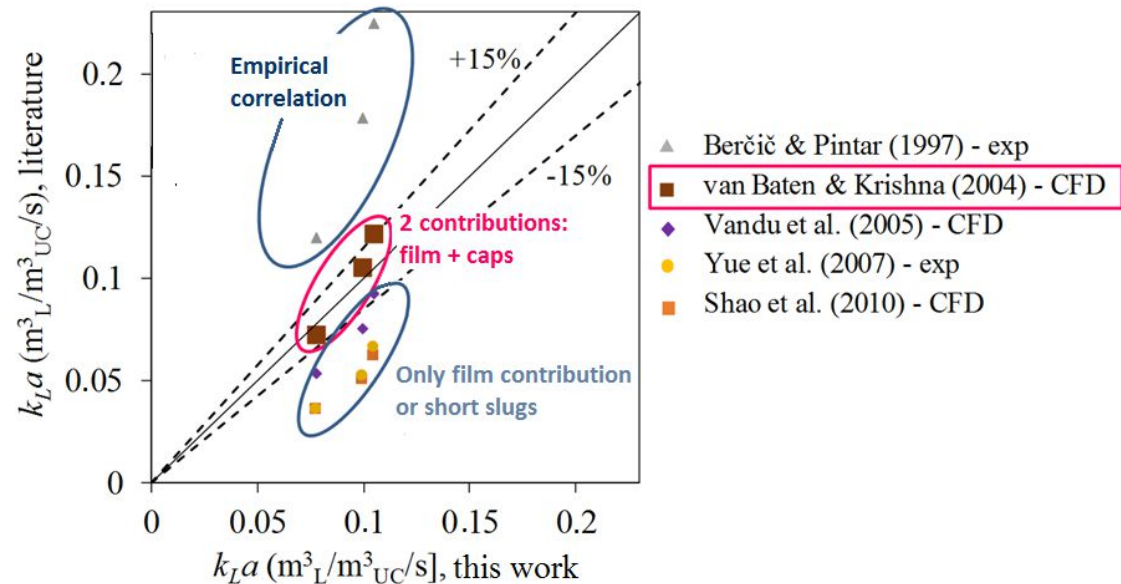

- ✓ higher  $k_L a$  value by up to 35% in short UC
- ✓  $k_L a$  values in accordance with literature

# Model validation

“Theoretical”: absorption of  $O_2$  in water  
(van Baten & Krishna, 2004)

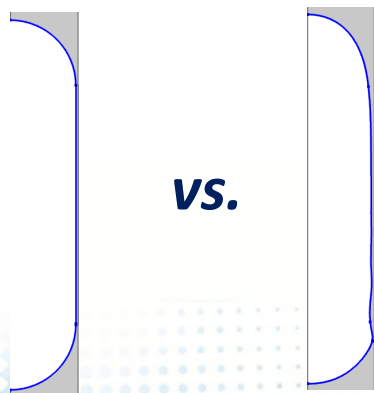

vs.

Two-phase calculation,  
with interface location  
determined by moving  
mesh method

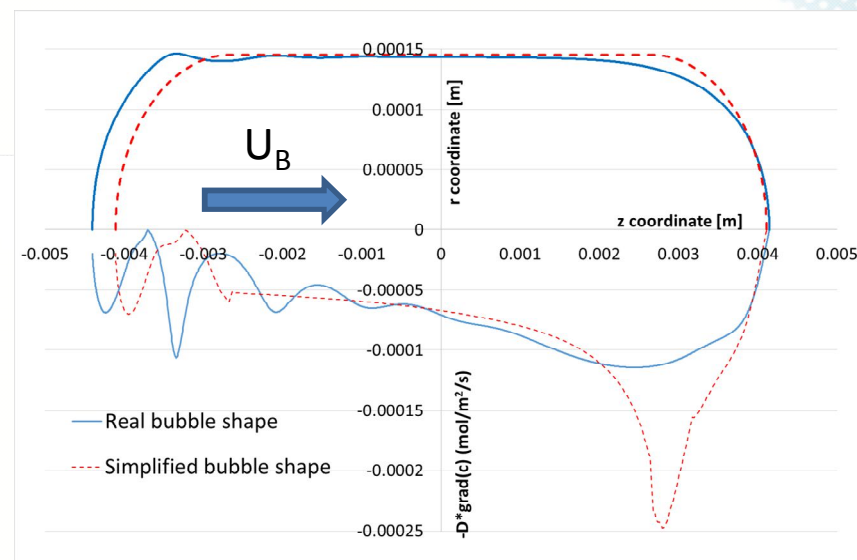

- ✓ higher  $k_L a$  value by up to 35% in short UC
- ✓  $k_L a$  values in accordance with literature
- ✓ overestimation by 15% from geometry simplification ( $Ca \sim 0.004$ )



# Model validation

**"Theoretical":** absorption of  $O_2$  in water (van Baten & Krishna, 2004)

- ✓ higher  $k_L a$  value by up to 35% in short UC
- ✓  $k_L a$  values in accordance with literature
- ✓ overestimation by 15% from geometry simplification ( $Ca \sim 0.004$ )

**Experimental:** pinene hydrogenation  
1.7% Pd/Al<sub>2</sub>O<sub>3</sub>

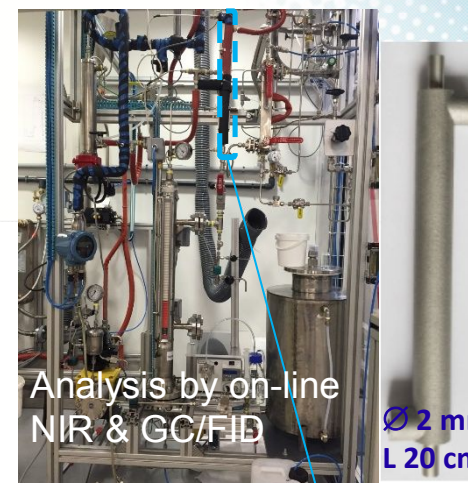
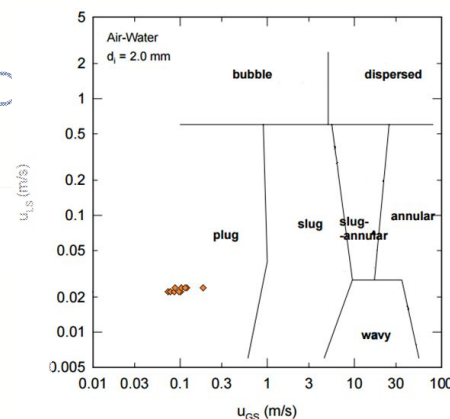

$T = 100-160^\circ C$ ,  $P_{H_2} = 10-20$  bar

$O_2$  / water

$H_2$  / pinene

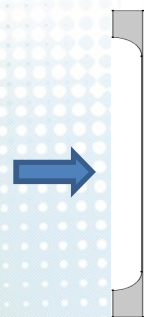

$L_{UC} = 40$  mm  
 $\delta_f = 48$   $\mu$ m  
 $U_B = 0.30$  m/s  
 $\epsilon_G = 0.17$

$L_{UC} = 16$  mm  
 $\delta_f = 30$   $\mu$ m  
 $U_B = 0.14$  m/s  
 $\epsilon_G = 0.77$

- Transient calculation
- No limitation by internal diffusion ( $e_{wc} \sim 10$   $\mu$ m)
- Isothermal cell
- Constant bubble shape &  $\epsilon_G$

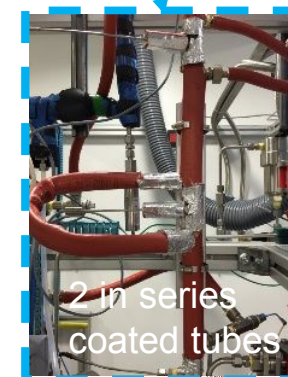

**Intrinsic kinetics from autoclave exp**

# $\alpha$ -pinene hydrogenation: kinetic study

**Stirred autoclave reactor:**  
with **gas ballast & addition funnel**

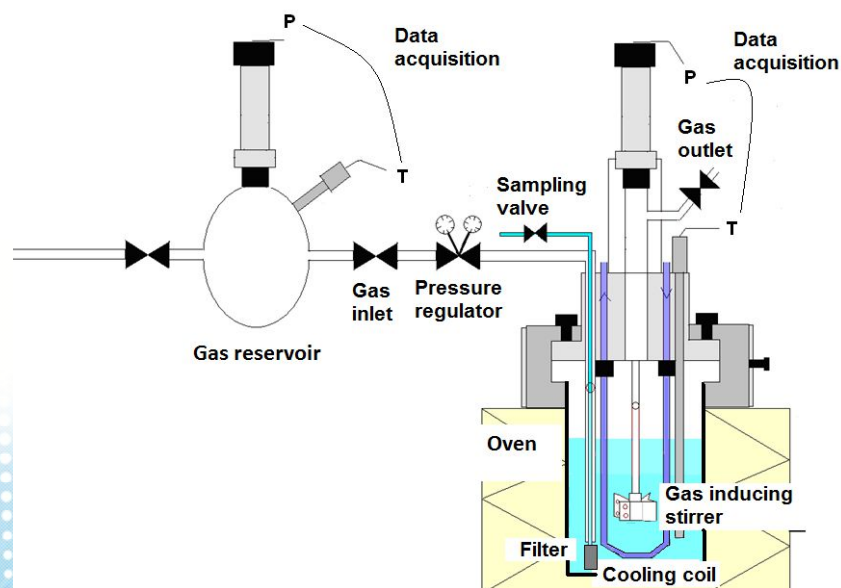

- Controlled T and atmosphere ( $p_{H_2}$ )
- Gas auto-dispersing stirrer (1200 rpm)
- Continuous recording of  $H_2$  consumption (initial hydrogenation rate  $R_{0,H_2}$ )

**catalytic platelet**  
(5-20 mg of coating)

or **powder** (5-50 mg)

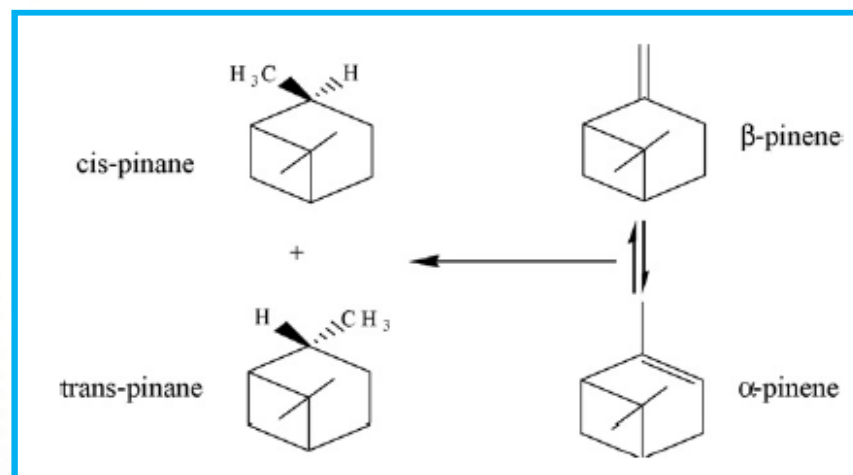
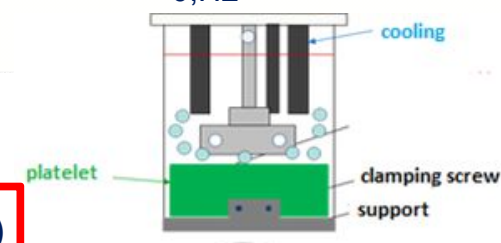

**Analysis of liquid samples:** GC/FID ( $\alpha$ - and  $\beta$ -pinene, cis- and trans-pinane)



# $\alpha$ -pinene hydrogenation: kinetic study

**Experimental database:**  $T = 100\text{-}160^\circ\text{C}$ ,  $p_{\text{H}_2} = 10\text{-}30$  bar,  $C_p = 1.5\text{-}6$  mol/L, 50 mL liquid, 25 mg cata ( $d_{43} = 30$   $\mu\text{m}$ )  $\rightarrow$  **18 experiments**

**Reaction selectivity:**  $< 5\%$  of  $\beta$ -pinene, cis-pinane selectivity: 60-70%  
Evolution with  $T$  &  $p_{\text{H}_2}$  in accordance with literature trends

## Apparent reaction orders:

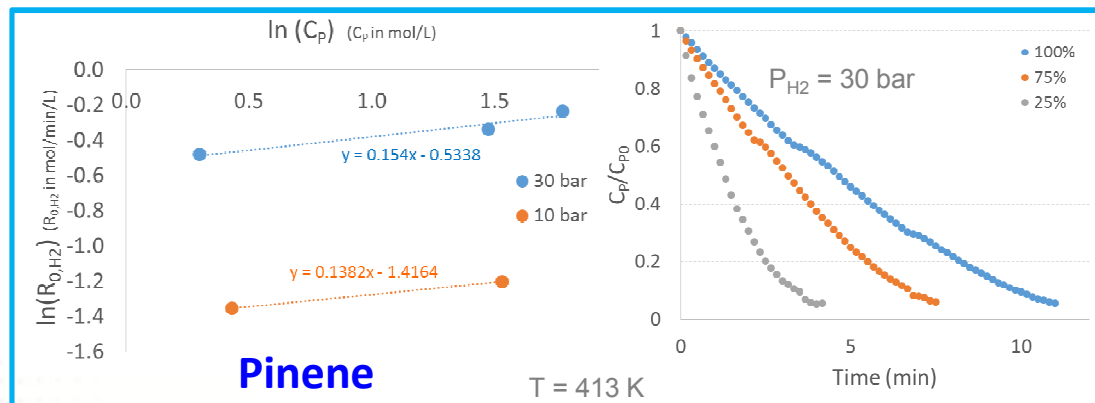
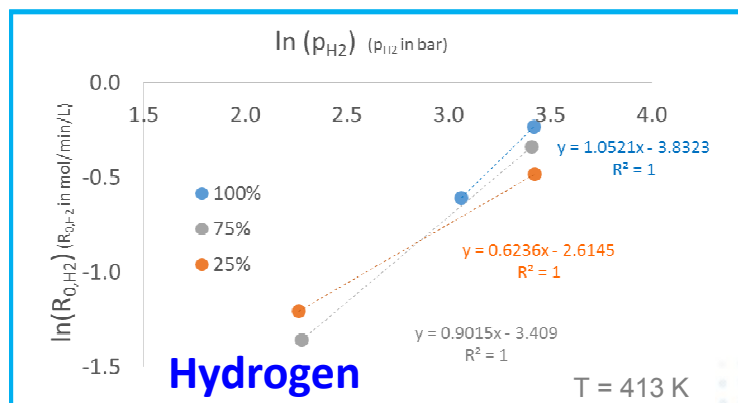

$\rightarrow$  between 0 and 1 (lower for P than for  $\text{H}_2$ )

## Apparent activation energy:

$\rightarrow 41 \pm 3$  kJ/mol

$\rightarrow$  close to the value of Il'ina et coll., 2000 (Pd/C)

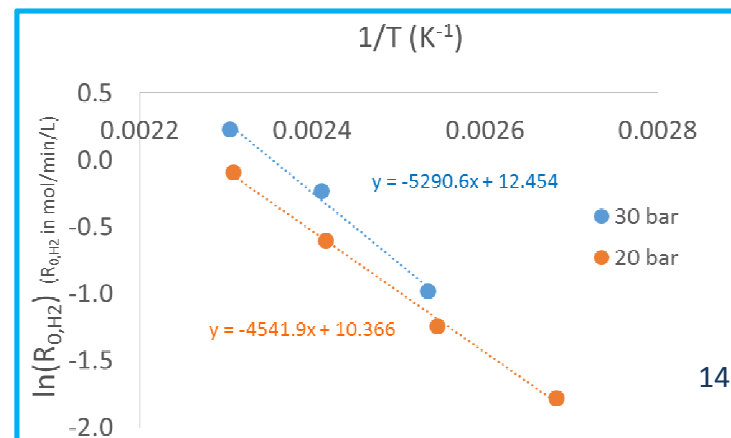

# $\alpha$ -pinene hydrogenation: kinetic study

## Selected model:

Model discrimination & parameter estimation based on  $R_{0,H_2}$  then **complete kinetic curves**

$$R_{H_2} = \frac{kK_{H_2}K_P P_{H_2} C_P}{(1 + \sqrt{K_{H_2} P_{H_2}} + K_P C_P)^3}$$

(dissociative adsorption of  $H_2$ ,  
surface reaction as rate-determining step)

## Results:

Parameter	Value	Unit	RSD
$k_0$	3.9E+10	mol.s <sup>-1</sup> .kg <sup>-1</sup> <sub>cat</sub>	18%
$K_{P,0}$	3.5E-03	L/mol	37%
$K_{H_2,0}$	4.2E-06	bar <sup>-1</sup>	12%
$E_a$	54.4	kJ/mol	1%
$\Delta H_{ad,P}$	-12.5	kJ/mol	10%
$\Delta H_{ad,H_2}$	-19.6	kJ/mol	4%

Mean  $R^2 = 0.94$

$$k(T) = k_0 e^{\left(-\frac{E_a}{RT}\right)}$$

$$K_i(T) = K_{i,0} e^{\left(-\frac{\Delta H_{ad,i}}{RT}\right)}$$

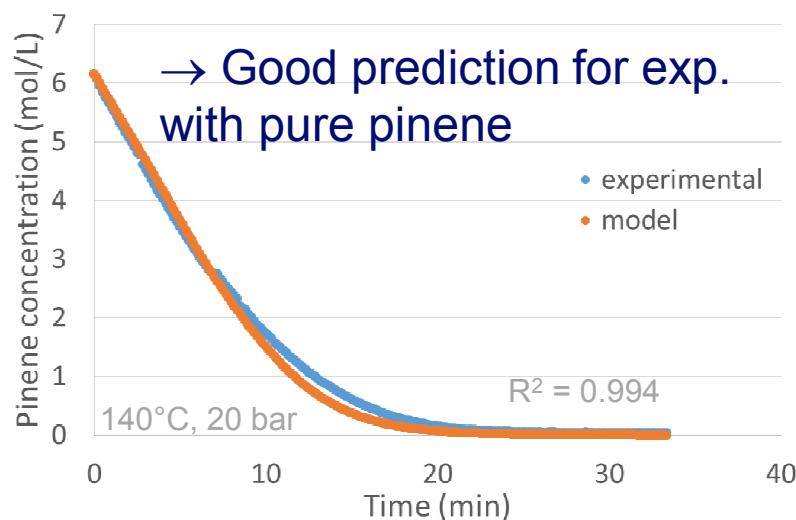



# $\alpha$ -pinene hydrogenation: catalytic capillary reactor

## CFD model:

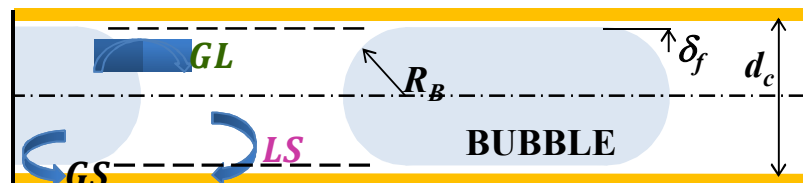

Individual mass transfer coefficients in agreement with literature, except  $k_{LS}$  for  $\alpha$ -pinene (resistance underestimated by tested correlations)

## 1D heterogeneous model:

Plug flow model accounting for external mass transfer resistances

**Similar behavior of CFD & 1D models**  
with adequate mass transfer coefficients

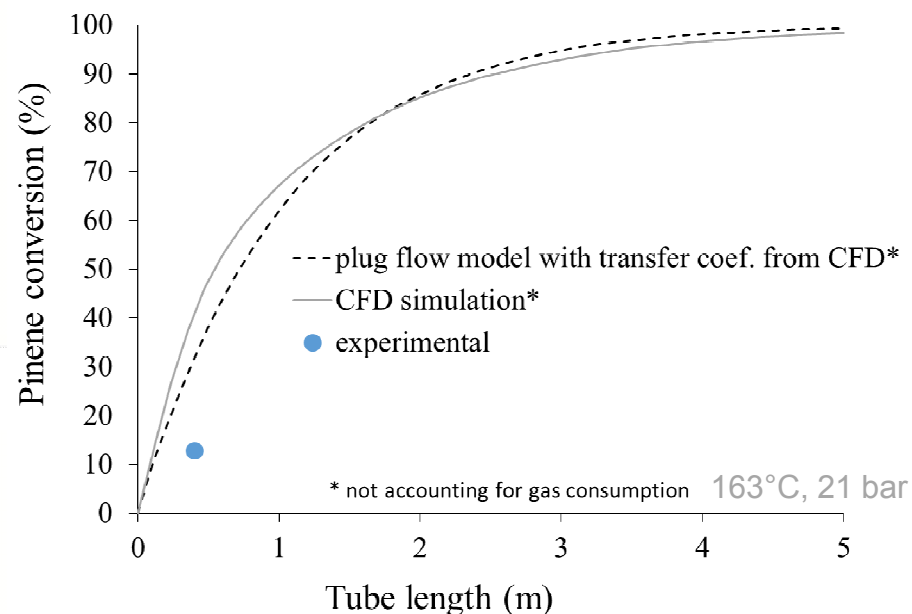

# $\alpha$ -pinene hydrogenation: catalytic capillary reactor

## CFD model:

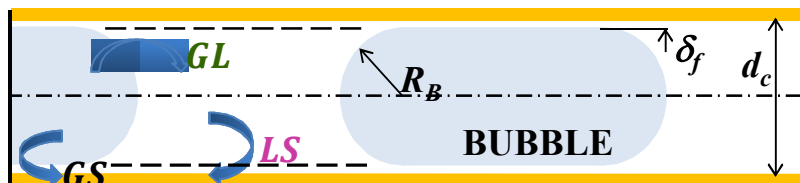

Individual mass transfer coefficients in agreement with literature, except  $k_{LS}$  for  $\alpha$ -pinene (resistance underestimated by tested correlations)

## 1D heterogeneous model:

Plug flow model accounting for external mass transfer resistances

Similar behavior of CFD & 1D models with adequate mass transfer coefficients

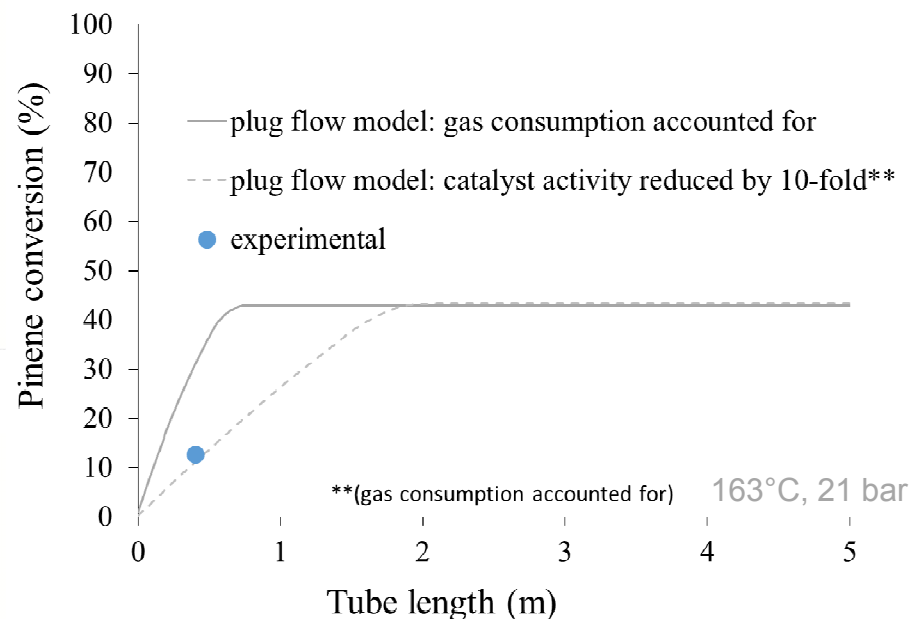
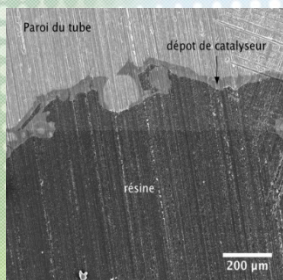

but too optimistic predictions vs. measured conversion

- Taylor regime? (effect of wall rugosity?)
- Overestimated  $k_L a$  value? ( $\epsilon_G$  constant, arbitrary  $L_{UC}$ )
- Impact of catalyst deactivation?
- Distinct activity of washcoat & powder?



# $\alpha$ -pinene hydrogenation: catalytic monolith reactor

## Sizing tool:

- Representation of several channels through 1D model
- H<sub>2</sub> consumption accounted for
- Simulation for a given liquid maldistribution (from exp. data)

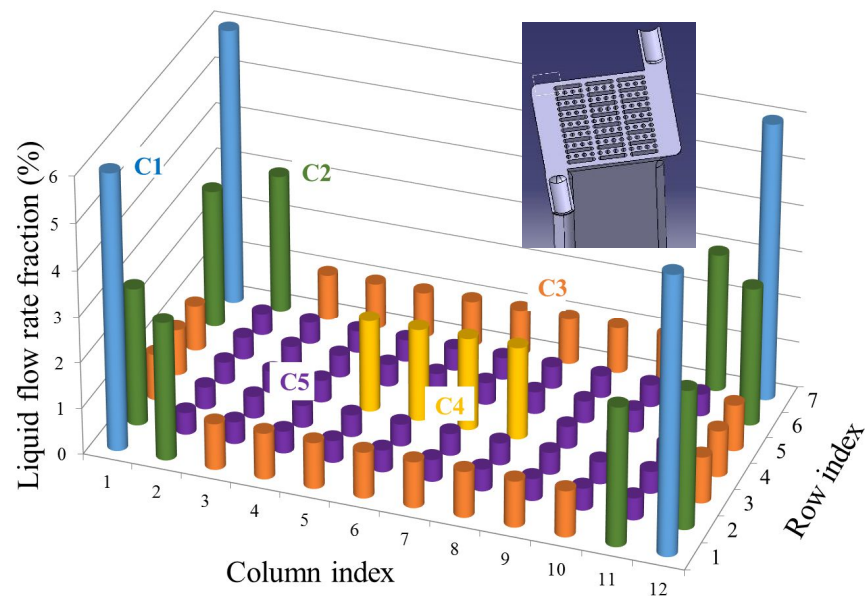

*Simplified liquid distribution:  
5 channel groups (C1 – C5)*

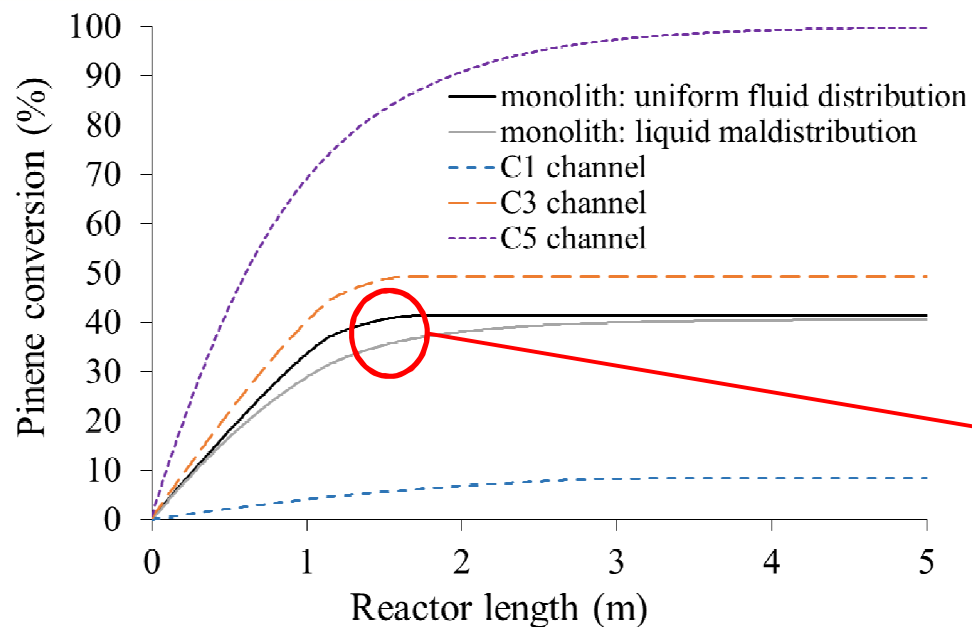

**Maldistribution  $\approx$  homogeneous case**  
probably due to a near zero-order  
kinetics with respect to  $\alpha$ -pinene

# Conclusions & perspectives

- Modelling strategy for a heat exchanger-monolith reactor**  
 Integrative approach, from local scale (periodic unit cell) towards macroscale (1D plug flow model) → **sizing reactor tool**  
 To be further considered: discrepancies with experiments in catalytic tubes
- Other perspectives of HYDROMoRe project**

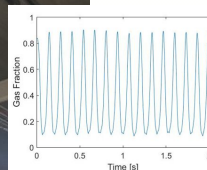
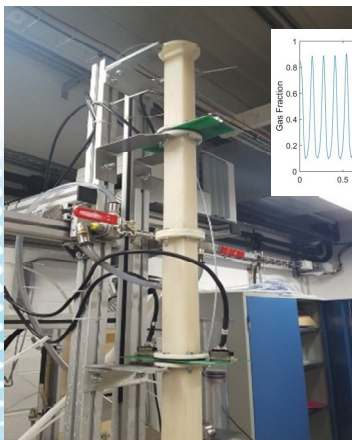

## Multi-channel hydrodynamic probing

(A. Billet, A. Devatine, H. Chaumat, I. Coghe, C. Julcour)

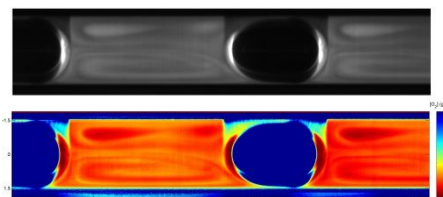

## Local concentration field of dissolved $O_2$ by PLIF-I in glass capillary tube and DNS

(A. Billet, E. Cid, B. Lalanne)



## Selective hydrogenation of edible oil

## in heat exchanger-reactor

(P. Albrand, A. Billet, C. Julcour, F. Larachi)







## Acknowledgements



Agence Nationale de la Recherche  
**ANR** Agence Nationale de la Recherche



**Total Oil & Gas company,**

Other project partners (**LCA**, **LISBP**) & students (*A. Duda*, *P. Saint- Martory*, *V. de Souza Godim de Oliveira*, *L.S. Garcia Landois Fernandez*, *C. Leleu*),  
for their valuable contribution;

Our technical staff: J. Labadie, J.L. Labat, B. Boyer & I. Coghe,  
for designing & setting up the reactor pilots

Pr. David Fletcher for useful discussion on the Unit Cell model

Thank you for your kind attention!

