



HAL
open science

Sensitivity analysis of complex engineering systems: Approaches study and their application to vehicle restraint system crash simulation

Gengjian Qian, Michel Massenzio, Denis Brizard, Mohamed Ichchou

► To cite this version:

Gengjian Qian, Michel Massenzio, Denis Brizard, Mohamed Ichchou. Sensitivity analysis of complex engineering systems: Approaches study and their application to vehicle restraint system crash simulation. *Reliability Engineering and System Safety*, 2019, 187, pp. 110-118. 10.1016/j.ress.2018.07.027 . hal-01908980v2

HAL Id: hal-01908980

<https://hal.science/hal-01908980v2>

Submitted on 8 Apr 2019

HAL is a multi-disciplinary open access archive for the deposit and dissemination of scientific research documents, whether they are published or not. The documents may come from teaching and research institutions in France or abroad, or from public or private research centers.

L'archive ouverte pluridisciplinaire **HAL**, est destinée au dépôt et à la diffusion de documents scientifiques de niveau recherche, publiés ou non, émanant des établissements d'enseignement et de recherche français ou étrangers, des laboratoires publics ou privés.

Sensitivity Analysis of Complex Engineering Systems—Approaches Study and their Application to Vehicle Restraint System Crash Simulation

Gengjian Qian^a, Michel Massenzio^{a,*}, Denis Brizard^a, Mohamed Ichchou^b

^a*Univ Lyon, Université Claude Bernard Lyon 1, IFSTTAR, LBMC, UMR T9406, F69622, Lyon, France*

^b*Laboratoire de Tribologie et Dynamique des Systèmes, Ecole Centrale de Lyon, 36, Avenue Guy de Collongue, 69134 Ecully, France*

Abstract

Restricted by high calculation cost of single engineering model run and large number of model runs for sampling-based Sensitivity Analysis (SA), qualitative SA are used for parameter study of the Vehicle Restraint System (VRS) and quantitative SA of such models has always been a challenge. Sequential approaches are proposed for SA of complex systems and the SA of a VRS is realized: sampling-based SA methods are discussed; SA of a simple three points dynamic bending test model is realized, the aims are to compare different two-level screening methods and put into practice the sequential SA; crash test FE model of a VRS is created and used for SA; influential uncertain parameters of the VRS are identified qualitatively through screening analyses (SA with Two-level screening and Morris Analysis), and Sobol' indices are used to quantify the influence of influential parameters with Kriging metamodeling. The uncertain parameters which contribute the most to robustness of the VRS are identified and their influences are quantified by combining screening analyses and Sobol' Indices.

Keywords: Crash simulation, Vehicle Restraint System, Metamodel, Sensitivity Analysis, Robustness analysis

*Corresponding author

Email addresses: qgjian000@gmail.com (Gengjian Qian),
michel.massenzio@univ-lyon1.fr (Michel Massenzio)

Nomenclature

CD	Cotter's Design
CDF	Cumulative Distribution Function
DOE	Design of Experiment
FD	full Factorial Design
FE	Finite Element
FFD	Fractional Factorial Design
HFFD	Half Fractional Factorial Design
LHS	Latin Hypercube Sampling
MA	Morris Analysis
OA	Orthogonal Arrays
OAT	One-at-A-Time
PCE	Polynomial Chaos Expansion
PS	Parameter Study
SA	Sensitivity Analysis
VBSA	Variance Based Sensitivity Analysis
VRS	Vehicle Restraint System

1. Introduction

Sensitivity Analysis (SA) is the study of how the uncertainty in a model output can be apportioned to different sources of uncertainty in its input [1]. The responses of engineering systems cannot be predicted precisely because the existence of uncertainty. Model can be simplified through SA by fixing non-influential parameters and focusing on the ones whose uncertainties have a great influence on system performances.

The Vehicle Restraint Systems (VRS) are specially designed to restrain an errant vehicle by dissipating or absorbing the impact energy and redirecting the vehicles to reduce the severity of impact. Crash test of VRS is commonly associated to the development of new devices, but it provides a view of the VRS performance of only one set of parameters. The real crash conditions of a vehicle with VRS (e.g. vehicle dimensions & mass, impact speed & angle, etc.) can be innumerable. Standards such as EN1317 [2] in Europe and MASH [3] in the United States normalize the crash test conditions a VRS should undergo to be in a certain performance class. Influenced by system uncertainties (e.g. uncertainty of material mechanical properties, tolerances of manufacture, installation conditions), the results can be different for two crash tests even with the same controlled test conditions. Dynamic FE simulation with programs such as LS-DYNA [4][5] is used in the crash simulation of VRS [6][7], and it allow the optimization [8][9] and robustness evaluation of a design taking into account all the variations. SA of VRS helps to have a deep understanding of model uncertainty and to identify the influential uncertain parameters that should be taken into considerations during VRS performance studies and robust optimizations.

Challenges for SA of VRS and many other complex engineering systems with numerical simulations include: a high simulation cost of single model run;

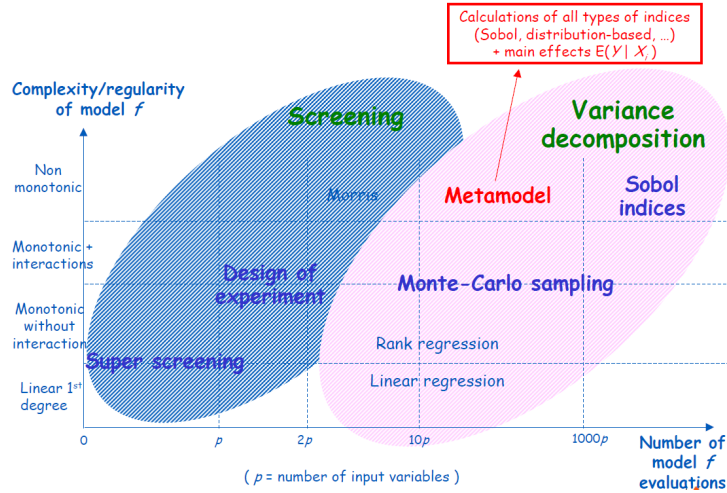

Figure 1: Selection of SA methods[11]

a large number of uncertain parameters; numerical errors in the modeling and simulation process (e.g. inaccurate physics models, simplification in modeling, FE program accuracy, etc.). The SA of a VRS is realized by combining qualitative and quantitative methods: Sampling-based SA methods are discussed in section 2; SA of a simple dynamic model, three point dynamic bending test of steel reinforced wood beam, is realized in order to find an efficient way for SA of the complex models, and the strategy for sequential SA (i.e. SA with sequential steps by combining different methods) of the VRS is proposed in section 3; SA of a VRS with the proposed strategy is presented in section 4; Conclusions are given in section 5.

2. Sampling based Sensitivity Analysis

Sampling-based [10] approaches for SA are both effective and widely used. The methods selection for SA of a model is based on the complexity of model and the number of variables (see Fig.1 [11]). Different SA methods might be needed for analysis of complex models: Fig.2 [12] illustrates the SA strategies.

Regression [13] analyses are the methods that could be used to discuss the linear relationship between inputs and outputs. Differential approach [1] reduces the samples by estimating the model input and output relationship only at a local position. Generally, properties are unknown for an engineering system. Screening basing on a two-level DOE is efficient for SA of a monotonic model [1][14]. Multi-level screening, Morris Analysis (MA) [1][14], can be used for SA of non-monotonic systems. Variance Based Sensitivity Analysis (VBSA), Sobol' indices [1][14], can quantify the main effect and the interaction effects of each input parameter on outputs, regardless of the linearity and monotonicity of the system, and the metamodel could be used for the calculation of Sobol' indices

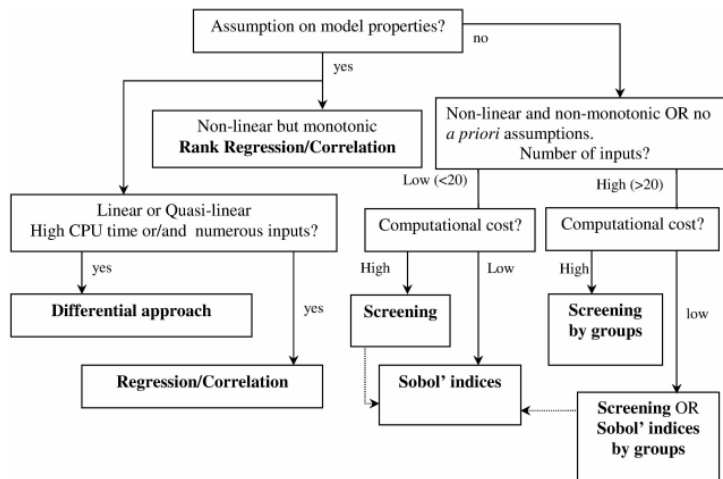

Figure 2: SA strategies for different kind of systems[12]

as it requires thousands of model evaluations. Group sampling [14] allows the analyst to generate smaller designs that can still isolate influential parameters, and is proposed when the number of inputs is high (>20).

For the VRS studied, model simulation is of high computational cost (5h/runs) and eleven input uncertain parameters are chosen. Sobol' indices can be used for quantitative SA of such models. Screening analyses are preferred to identify the influential uncertain parameters and to reduce the number of input parameters before the quantitative analysis.

2.1. Screening analysis

The choice of a well-designed experiment for the screening analysis is essential to identify qualitatively the few influential uncertain parameters.

2.1.1. Two-level Design of Experiment

Two-level analysis [1][14], namely each input variable has two values. The main effect $ME_r(Y)$ of parameter X_r on Y is obtained by taking half the difference of the average Y values for X_r at the two levels:

$$ME_r(Y) = \frac{1}{2} \left(\frac{1}{k_1} \sum_{x_{jr}=1} y_j - \frac{1}{k_0} \sum_{x_{jr}=0} y_j \right) \quad (1)$$

where k_1 is the number of samples with X_r at level 1 and k_0 is the number of samples with X_r at level 0. SA analysis with inputs at only two levels can greatly reduce the required number of samples, but no information is obtained about linearity or continuity of the model and it can only be used for screening analysis of monotonous models.

Parameter Study. Each parameter is varied independently over the two levels, holding all others at the specified baseline design. A small number of samples are used, but it does not account for interactions among parameters.

One-at-A-Time. The value of only one parameter is changed between two consecutive simulations. This sampling strategy is efficient for linear model analysis. Supposing:

$$Y = b_0 + \sum_{r=1}^k b_r X_r \quad (2)$$

With the One-at-A-Time (OAT) DOE, we have the following equation, and the quantity $\Delta y_i = y_{i+1} - y_i$ is an estimate of the effect on Y of changing X_i .

$$\begin{bmatrix} 1 & 0 & 0 & 0 & \dots & 0 \\ 1 & 1 & 0 & 0 & \dots & 0 \\ 1 & 1 & 1 & 0 & \dots & 0 \\ 1 & 1 & 1 & 1 & \dots & 0 \\ \vdots & \vdots & \vdots & \vdots & \ddots & \vdots \\ 1 & 1 & 1 & 1 & \dots & 1 \end{bmatrix} \begin{pmatrix} b_0 \\ b_1 \\ \vdots \\ b_k \end{pmatrix} = \begin{pmatrix} y_1 \\ y_2 \\ \vdots \\ y_{k+1} \end{pmatrix} \quad (3)$$

Full & Fractional Factorial Design. To take into consideration all the combinations of the k parameters at the 2 levels, 2^k samples are taken for full Factorial Design (FD). Therefore the main disadvantage of using a FD is the enormous number of simulations required, especially for models with many parameters. Fractional Factorial Design (FFD), consisting of a carefully chosen fraction of the full FD, can greatly decrease the number of samples. Although with relatively low accuracy, DOE with Orthogonal Array (OA) [15] is one of the most efficient sampling methods for FFD. Table 1 lists the OA for a two-level DOE of seven parameters (1 and -1 are the two levels taken for each parameter). Only 8 samples are chosen for SA of a model with 7 parameters: note that half the values in each column are 1, and that the others are -1; any two columns have the property that the four combinations (1, 1), (1, -1), (-1, 1), (-1, -1) occur the same number of times.

2.1.2. Cotter's Design

Cotter's Design (CD) [1] is a systematic fractional replicate design that requires the following $2k + 2$ runs for parameter screening of the model with k parameters:

- One initial run with all parameters at their low levels;
- k runs with each parameter in turn at its upper level, while all other parameters remain at their low levels;
- k runs with each parameter in turn at its low level, while all other parameters remain at their upper levels;

Table 1: Two-level Orthogonal Array for seven parameters

X_1	X_2	X_3	X_4	X_5	X_6	X_7
1	1	1	1	1	1	1
1	1	1	-1	-1	-1	-1
1	-1	-1	1	1	-1	-1
1	-1	-1	-1	-1	1	1
-1	1	-1	1	-1	1	-1
-1	1	-1	-1	1	-1	1
-1	-1	1	1	-1	-1	1
-1	-1	1	-1	1	1	-1

- One run with all parameters at their upper levels.

Denote the resulting outputs by $y_0, y_1, y_2, \dots, y_{2k+1}$. Then following measures can be used to estimate the order of importance for the parameters:

$$\begin{aligned}
 M(j) &= |C_e(j)| + |C_o(j)| \\
 \text{with} & \\
 C_e(j) &= \frac{1}{4} [(y_{2k+1} - y_{k+j}) - (y_j - y_0)] \\
 C_o(j) &= \frac{1}{4} [(y_{2k+1} - y_{k+j}) + (y_j - y_0)]
 \end{aligned} \tag{4}$$

A major problem of the Cotter's method is that an important parameter may remain undetected. The measures may fail when a parameter has effects that cancel each other out.

2.1.3. Multi-level screening—Morris Analysis

MA [1][14][16] (i.e. Elementary Effect Method) is based on the concept that two successive points within a trajectory differ from each other only in one dimension by a fixed amount Δ . Consider a model with k independent inputs which varies in the k -dimensional unit cube across p selected levels. The elementary effect of the i th input parameter EE_i is defined as:

$$EE_i = \frac{Y(X_1, X_2 \dots X_i + \Delta, \dots, X_k) - Y(X_1, X_2, \dots)}{\Delta} \tag{5}$$

where Y is the model under study and k is the number of model parameters. One EE is produced per parameter from each trajectory. It estimates at different points in the input space the main effect of a parameter by computing a number r of trajectories with $k + 1$ model evaluations for each trajectory, and then taking their average. The average value of EE_i for the r trajectories μ_i and its variance σ_i^2 are calculated with eq.6 and eq.7. However, μ_i may not detect some parameters to be influential due to positive and negative EE_i values canceling each other for non-monotonous models. Instead of μ_i , the mean of the absolute values of EE_i eq.8 [17] is recommended for main effect calculation of a parameter.

$$\mu_i = \frac{1}{r} \sum_{j=1}^r EE_i^j \quad (6)$$

$$\sigma_i^2 = \frac{1}{r-1} \sum_{j=1}^r \left(EE_i^j - \mu_i \right)^2 \quad (7)$$

and

$$\mu_i^* = \frac{1}{r} \sum_{j=1}^r \left| EE_i^j \right| \quad (8)$$

MA can determine which input parameters could be considered to have effects which are negligible, linear and additive, or nonlinear or involved in interactions with other parameters. This method is ideal when the number of input parameters is too large to allow the application of computationally expensive quantitative analysis. It helps to identify the few parameters that are influential and the reduction of the input variables makes quantitative SA possible for complex engineering systems.

2.2. Sobol' indices

Working within a probabilistic framework, the VBSA [1][14][18] decomposes variance of the model output into fractions which can be attributed to inputs. For model $Y(X)$, where $X = (X_1, X_2, \dots, X_k)$ is the k -dimensional input vector. With the hypothesis that all input variables are independent with each other, the variance of output $V(Y)$ can be decomposed as partial variances of increasing orders:

$$V(Y) = \sum_{i=1}^k V_i + \sum_{i \neq j} V_{ij} + \dots + V_{12\dots k} \quad (9)$$

where

$$\begin{aligned} V_i &= V(E(Y|X_i)) \\ V_{ij} &= V(E(Y|X_i, X_j)) - V_i - V_j \\ V_{ijl} &= V(E(Y|X_i, X_j, X_l)) - V_i - V_j - V_l \\ &\quad - V_{ij} - V_{jl} - V_{il} \\ &\dots \end{aligned}$$

Let $S_i = V_i/V(Y)$, $S_{ij} = V_{ij}/V(Y)$, etc. Then

$$\sum_{i=1}^k S_i + \sum_{i \neq j} S_{ij} + \dots + S_{12\dots k} = 1 \quad (10)$$

where S_i is first order effect index to measure the individual contribution of X_i to the model output variance; S_{ij} is second order effect index which quantifies the interactive contribution between X_i and X_j to variance of output, etc.

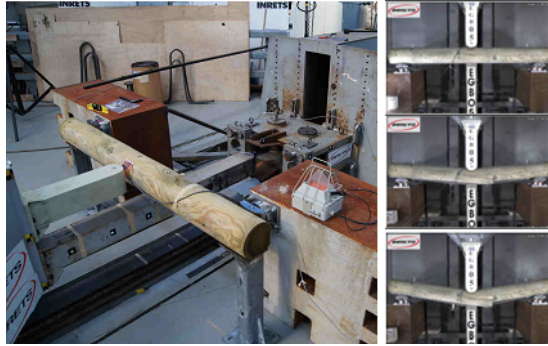

Figure 3: Bending test of steel reinforced wood Beam[22]

Eq.10 has $2^k - 1$ terms and it is not practical to calculate all the indices. Total effect index S_{T_i} is defined as the sum of all order effect indices of X_i :

$$S_{T_i} = S_i + \sum_{j=1, j \neq i}^k S_{ij} + \dots + S_{12\dots k} \quad (11)$$

Sobol' indices can deal with nonlinear responses and measure the effect of interactions in non-additive systems. Usually only first and total order effects indices, S_i and S_{T_i} , are estimated to measure sensitivity across the whole input space: S_i reflects the main effect of an input X_i and S_{T_i} accounts for the total contribution to the output variation due to the variation of X_i .

VBSA can quantify the influences of inputs uncertainties on the model performances. Saltelli [14] described the Monte-Carlo based procedure for the computing of S_i & S_{T_i} and proposed the improvements [19]. However large number of samples is still needed and the model runs increase linearly with the number of input variables. Kriging metamodeling is highly efficient in calculation of the Sobol' indices[20] and has been integrated in mathematical softwares such as the Matlab toolbox DACE[21].

3. Approach study

3.1. SA of a bending test model

The three points dynamic bending test of a steel reinforced wood beam was realized (see Fig.3) and the numerical simulation was carried out using Ls-Dyna (see Fig.4) [22]. The wood beams consisted in cylinders of 200 mm in diameter and a length of two meters, with the rear side machined and reinforced with a S235 steel plate. A rigid impactor of 2000 kg impacts the beam at 20 km h^{-1} . Screening methods and Sobol' indices are used for SA of the simple dynamic model: efficiency and accuracy of different methods are compared.

Six uncertain parameters are chosen: Wood mechanical properties are influenced by its Moisture Content (MC), Temperature (T) and wood Grade

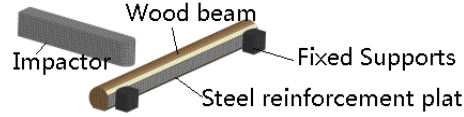

Figure 4: Numerical model of the bending test[22]

Table 2: Distribution of uncertain parameters for the test

Factors	Distribution	Unit	Mean	St D
MC	Uniform	%	16.5	4.9
T	Uniform	$^{\circ}\text{C}$	15.5	8.37
G	Gauss	1	0.635	0.135
Y	Gauss	MPa	284.5	21.5
MY	Gauss	GPa	210	12.6
MT	Gauss	GPa	0.86	0.08

(G) [23]; Uncertainties of mechanical properties of the reinforced plate, Yield strength (Y), Young’s Modulus (MY), Tangent Modulus (MT), are considered [24]. The possible distributions of the uncertain parameters are listed in Table 2. Fig.5 shows velocities of the impactor with uncertain parameters at different possible values. Mechanical properties of the beam are highly influenced by uncertain parameters. The final velocity (v_{∞}) of the impactor reflects ability of the beam to absorb the impact energy and is treated as the output criterion.

Different screening methods—MA, FD, HFFD, OA, OAT, CD, PS, are used for screening analyses of the system. Influential uncertain parameters are identified and their influences are then quantified by calculating the Sobol’ indices. The normalized main effects of the uncertain parameters are listed in Table 3 :

- The Cumulative Distribution Function (CDF) value of a parameter is unitless and uniformly distributed across the interval $[0, 1]$ regardless of the parameter distribution. In the MA, the CDF values of the parameters

Table 3: SA of the bending test model with V_{∞} as output

	MC	T	G	Y	MY	MT
MA	0.11	0.41	0.26	0.06	0.04	0.12
FD	0.14	0.47	0.28	0.03	0.02	0.06
HFFD	0.17	0.48	0.30	0	0.02	0.03
OA	0.12	0.30	0.28	0.08	0.02	0.20
OAT	0.16	0.26	0.20	0.25	0.10	0.03
CD	0.19	0.29	0.07	0.12	0.13	0.19
PS	0.20	0.09	0.49	0.03	0.04	0.15
Sobol	0.01	0.62	0.35			0.01

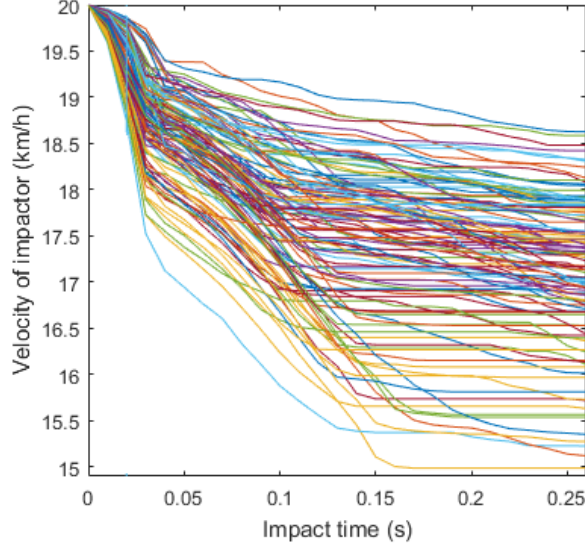

Figure 5: Impactor velocity in bending test simulations with uncertain parameters at different levels

were treated as inputs and 6 levels (1/12, 3/12, 5/12, 7/12, 9/12, 11/12) were taken for each input with $\Delta = 0.5$. 9 trajectories with each trajectory corresponds to 6+1 model executions based on One-at-A-Time sampling strategy were selected and a total number of 63 model runs were realized. The value of μ_i^* (see eq.8) was calculated. The multi-level MA is one of the most accurate screening method and the analysis results could be treated as a reference for accuracy evaluation of two-level screening analyses;

- Suppose that v_∞ is inversely proportional to rigidity of the beam. For two-level screening analyses: values of inputs G , Y , MY , MT are taken as the mean value plus/minus standard deviation; Mechanical properties of wood [23] have monotonous relationship with MC in interval [8 30]% and with T in interval [1 30] °C. Low MC may greatly degrade properties of the wood and its energy absorption capability goes down when wood freeze at $T < 0^\circ\text{C}$. Two levels of MC and T were taken as (8%, 26%) and (1°C, 30°C) separately. Considering all possible combinations, FD is the most accurate two-level screening method, with 64 model runs; HFFD take half of the full FD samples, i.e. 32 samples, and is of relatively high accuracy; only 8 samples were required for fractional design with OA, and the OA well identified the non-influential parameters; OAT design is efficient for linear models and needs 12 model runs to estimate the effect of changing each parameter, but it is of low accuracy for screening analysis of the bending test model; CD and PS take only one sample for every parameter at each level, and the screening results are highly influenced by

single model simulation precision;

- Both MA and FD screening results show that MC, T, G, MT are influential parameters. Their respective influences were then quantified with Sobol' indices. Though a single run of the bending test model requires only $10min$, thousands of samples are needed for quantitative analysis. About 120 model runs were realized with samples generated through Latin Hypercube Sampling (LHS) in order to create the Kriging metamodel and Sobol' indices were calculated with the Monte-Carlo based procedure [19] using the metamodel. Main effect S_i for each parameter is listed in the table 3, wood Temperature (T) and wood Grade (G) were identified and their influences were quantified.

3.2. Approaches for SA of VRS

In the modeling of systems with unknown properties, screening analyses help to remove the noise and insignificant variables and terms, and to identify the interactions in problems[25]. They are proposed before quantitative analysis in the SA of complex models[12]. Both MA and Sobol' indices could be used in SA of black-boxes systems where no specific assumption is made. Lamoureux[26] realized the SA of an aircraft engine's pumping unit by combining MA and Sobol' indices. Ge[27] discussed the sequential SA with MA and Sobol' indices of the test functions (G function, G^* function, K function, *Morris* function): his study shows that the sequential SA has a very high accuracy in both qualitative and quantitative SA of a high-dimensional model.

Oberkampf[28] discussed error and uncertainty in model simulations. Numerical solution errors are inevitable in the modeling & simulation of complex systems, and the field of numerical error estimation is separate from that of uncertainty analysis. As for the dynamic problems, the simulation error at the previous moment may lead to bigger error of model at the latter moment. The simulation error of dynamic systems cumulated and its influences on the SA need to be considered. In the MA, numerical errors may dominate the EE_i calculation of non-influential parameters as show in eq.12 , where $Y(X_1, X_2 \dots X_i + \Delta, \dots) \approx Y(X_1, X_2, \dots)$ and e_{i1}, e_{i2} represent the numerical errors. Screening analyses with samples taken by FD or FFD run the model multiple times with every uncertain parameter at each level, which helps to offset the influence of numerical errors on uncertainty analysis of the complex systems. Screening methods such as OAT, CD and PS can be efficient for SA of models with special assumptions, but of low accuracy for complex model with unknown properties as they run the model only one//two times with every uncertain parameter at each level and the numerical error or the interaction effects of uncertain parameters could dominate the evaluation of main effect.

$$EE_i = \frac{[Y(X_1, X_2 \dots X_i + \Delta, \dots) + e_{i1}] - [Y(X_1, X_2, \dots) + e_{i2}]}{\Delta} \approx \frac{e_{i1} - e_{i2}}{\Delta} \quad (12)$$

Restrained by the high number of uncertain parameters and time expensive cost in the simulation of VRS crash tests, current SA of the VRS remain qualitative [29][30][31] and assumptions are made to cut back the number of uncertain parameters. By taking samples through FD, Goubel [29] analyzed qualitatively the robustness of a steel-wood VRS. His analysis could illustrate the uncertainty of model outputs, but only 3 uncertain parameters are analyzed according to the failure modes of the VRS during crash test. Many other uncertain parameters exist and the number of model runs could be numerous if we take samples considering all the uncertain parameters (n^k samples for n level FD of k uncertain parameters). Two-level screening with uncertain parameters taken through FFD (e.g. OA) could greatly reduce the number of samples required and well identify the non-influential uncertain parameters according to previous SA of the bending test. Comparing to MA, although could only be used in qualitative SA of monotonous models, two-level screening with FFD could eliminate the numerical error and identify the most non-influential uncertain parameters with much less samples and model runs.

As a consequence, the steps for SA of complex engineering systems (i.e. high calculation cost models) can be summarized as follows:

- 1) Two-level screening — OA
- 2) Multi-level screening—MA
- 3) Sobol' indices with Kriging metamodeling

A complex model may have tens or hundreds of input parameters, but only a few of them may be influential. By carefully choosing the samples, although with low precision, two-level FFD (e.g. OA) screening are of lowest calculation cost for SA to find the non-influential parameters. And the influences of numerical errors on SA could cancel each other out by running the model multiple times with every uncertain parameter at each level. VRS performances generally have monotonous relationship with rigidity of the device. Two-level screening methods can be used for SA of such models.

Limited by calculation precision, OA screening can only preliminarily select the parameters. Non-influential variables will then be treated as constant, which can greatly facilitate the multi-level screening. MA will then be used to classify the influential variables with a multi-level screening.

The few most important parameters may remain undetected through the first two steps. Sobol' indices will then be used to quantify the influences of parameters that are classified as influential in the MA. Even for a model with few parameters, thousands of model runs might be needed for the quantitative SA. Monte-Carlo based procedure can be used in calculation of the Sobol' indices with Kriging metamodeling.

4. VRS Sensitivity Analysis

4.1. VRS Crash Model

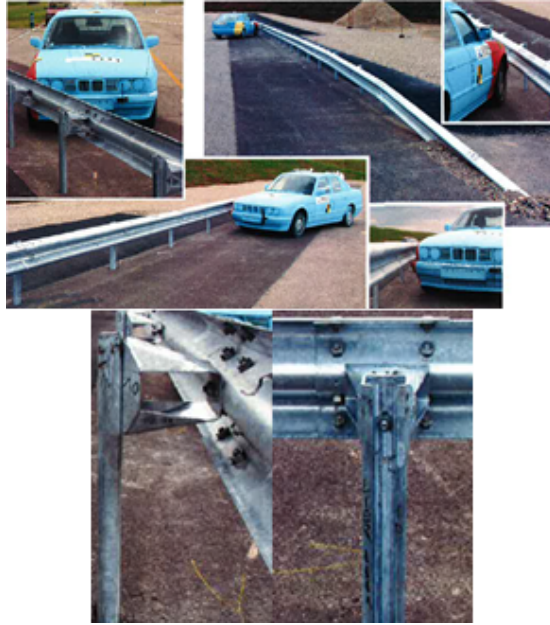

Figure 7: The VRS tested in [32]

model: the Rail-Rail connections are simplified with high-strength spring elements as no failure is detected for these connections; the bolted connections of Post-Spacer and of Spacer-Rail are modeled in detail. The bending of post, deformation of soil and bolted connection failure are well simulated in the FE model (see. Fig.11 and Fig.13).

Fig.14 compared the experimental test and simulation results at different impact time. The FE model has well simulated the crash test of VRS within 5 hours using a regular PC [33].

4.2. VRS Parameters & Performance Criteria

4.2.1. Model input parameters

Due to the material mechanical properties variations and the tolerances in manufacturing, the uncertainties of the following parameters are considered:

- 1) VRS components Rail, Spacer and Post are fabricated with structure S235 steel. S235 mechanical properties have been analyzed statistically in literature studies [24] Supposing that the steel tensile strength is proportional to its yield strength, uncertainties in steel mechanical properties influence Rail Yield strength (RY), Rail Young's Modulus (RM), Spacer Yield strength (SY), Spacer Young's Modulus (SM), Post Yield strength (PY) and Post Young's Modulus (PM);

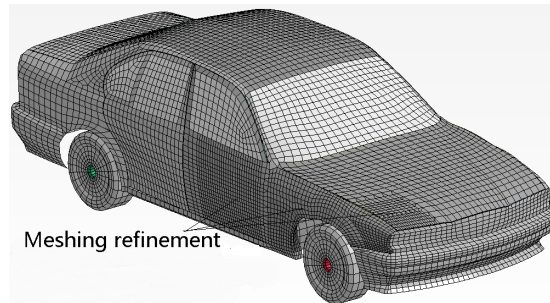

Figure 8: FE model of the vehicle

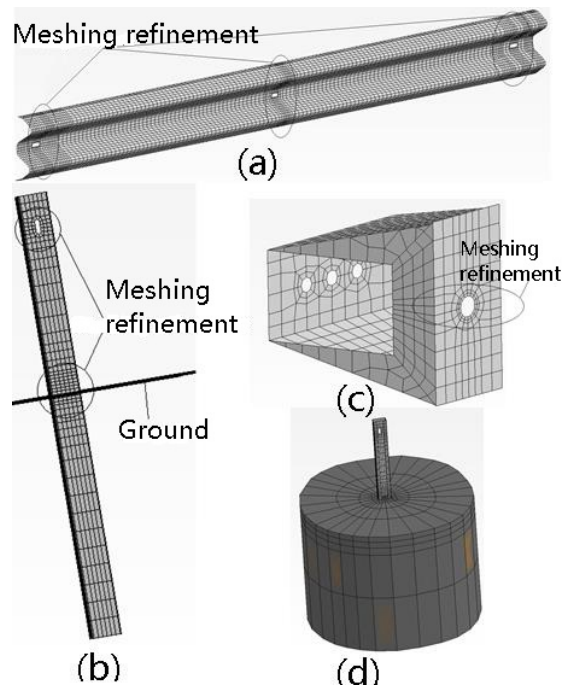

Figure 9: FE model of the VRS components

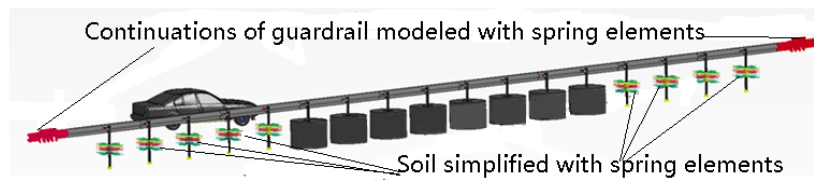

Figure 10: Simplified FE crash test model of VRS



Figure 11: Bolts pull out failure of post-spacer connection

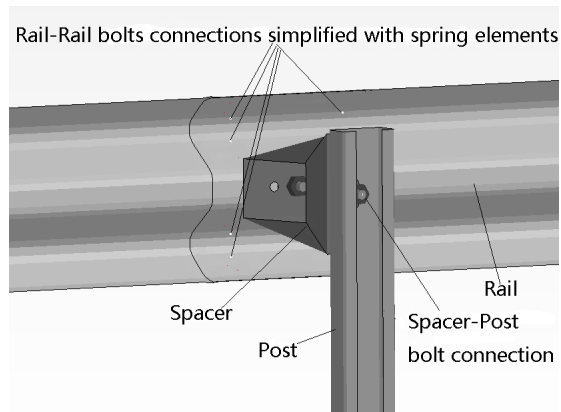

Figure 12: Bolted connections of VRS in the FE model

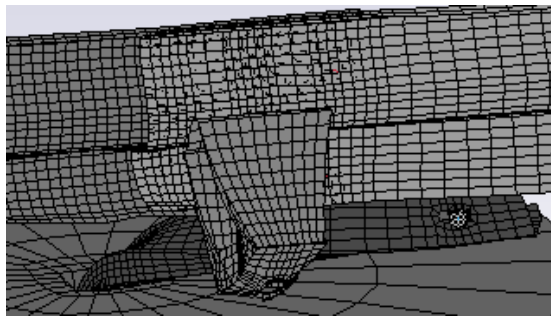

Figure 13: Bolted connection failure in the FE simulation

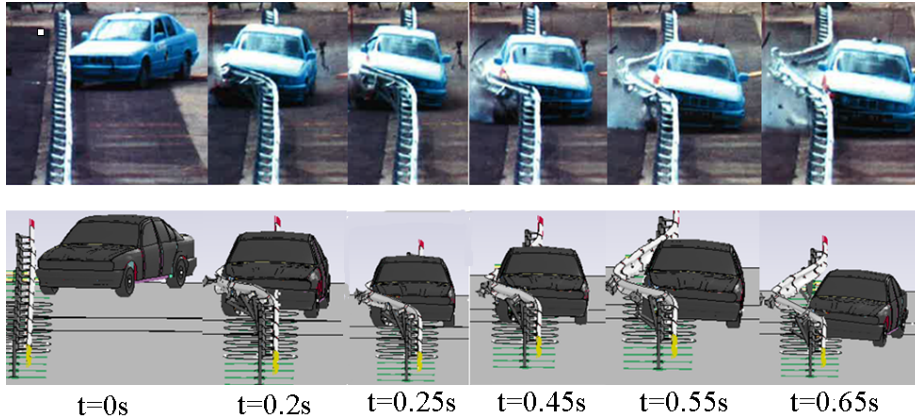

Figure 14: Crash test and simulation at different impact times

Table 4: VRS crashing model input variables

Type	Vars	Unit	Mean	St D
Steel S235 mechanical properties[24]	RY	MPa	284.5	21.5
	RM	GPa	203	12.6
	SY	MPa	284.5	21.5
	SM	GPa	203	12.6
	PY	MPa	284.5	21.5
Tolerances of fabrication	PM	GPa	203	12.6
	RT	mm	3	0.15
	ST	mm	3	0.15
Installation uncertainties	PT	mm	5	0.25
	$SoilM$	MPa	400	100
	BP	N	12432	4144

- 2) The designed Rail Thickness (RT), Spacer Thickness (ST) and Post Thickness (PT) are 3 mm, 3 mm and 5 mm respectively, and the standard deviations of the thickness parameters caused by the fabrication tolerances is defined to be 5% of their mean values;
- 3) Fixed to the ground, the VRS performances are affected by Soil bulk Modulus ($SoilM$) [34]. The VRS components are connected by bolts and the Bolt Pre-load (BP) is defined.

The uncertain parameters are supposed to have normal distributions, and their mean values and standard deviations are defined in Table 4.

4.2.2. Performance Criteria

Two performance criteria are defined:

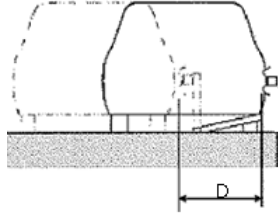

Figure 15: Dynamic deflection of a VRS[2]

- Impact severity Criterion [2] – the Theoretical Head Impact Velocity ($THIV$): the occupant is considered to be a freely moving object (head) that, as the vehicle changes its speed during contact with the safety feature, continues moving until it strikes an inner surface of the vehicle with the velocity $THIV$.
- Deformation of VRS [2] – the Dynamic deflection (D) is the maximum lateral dynamic displacement of the side facing the traffic of the VRS (see Fig.15).

4.3. VRS Model Variables Screening

4.3.1. Two-level screening—OA

Influences of the 11 uncertain parameters on the model performances are studied by two-level OA screening. The OA and the outputs $THIV$ and D are listed in Table 5. Columns in OA represent the 11 variables in Table 4. Every variable takes two values: 0, which corresponds to $\mu_k - \sigma_k$ and 1, which corresponds to $\mu_k + \sigma_k$ (μ_k : average value of parameter k ; σ_k : standard deviation of parameter k).

A total number of 12 model runs were realized. $ME_r(Y)$ of each variable on the two outputs $THIV$ and D were calculated and their influences were ranked from the most influential (1) to the least influential (11) according to absolute value of $ME_r(Y)$ in Table 6.

Limited by the analysis precision, the two-level screening with OA can only identify qualitatively the influential parameters. The first 4 influential parameters for both $THIV$ and D are chosen separately and a total number of 6 variables (variables on bold in Table 6) out of 11 are considered as influential after this analysis.

4.3.2. Multi-level Screening—MA

The 6 selected variables are re-screened with MA: 4 levels (1/8, 3/8, 5/8, 7/8) are taken for the CDF of each input variable with $\Delta = 0.5$. 6 trajectories with each trajectory corresponding to 7 model executions based on a Once-at-A-Time sampling strategy were selected and a total number of 42 model runs were realized. The analytical values are plotted in Fig.16, for both outputs $THIV$ and D .

Table 5: OA sampling and simulation outputs of the VRS

No.	OA	$THIV(km/h)$	$D(mm)$
1	1 1 1 1 1 1 1 1 1 1 1 1	22.4481	1044
2	1 1 1 1 1 0 0 0 0 0 0 0	21.2421	1182
3	1 1 0 0 0 1 1 1 0 0 0 0	20.3844	1221
4	1 0 1 0 0 1 0 0 1 1 0 0	21.5142	1160
5	1 0 0 1 0 0 1 0 1 0 1 0	21.4796	1170
6	1 0 0 0 1 0 0 1 0 1 1 0	20.2277	1159
7	0 1 1 0 0 0 1 0 0 1 1 0	21.5688	1213
8	0 1 0 1 0 0 0 1 1 1 0 0	21.5030	1186
9	0 1 0 0 1 1 0 0 1 0 1 0	22.9677	1150
10	0 0 1 1 0 1 0 1 0 0 1 0	21.5258	1246
11	0 0 1 0 1 0 1 1 1 0 0 0	22.1834	1092
12	0 0 0 1 1 1 1 0 0 1 0 0	22.3825	1167

Table 6: Main Effect for OA screening

Param.	$THIV$		D	
	$ME(km/h)$	Rank	$ME(mm)$	Rank
<i>RY</i>	-0.4029	1	-9.8	4
<i>RM</i>	0.1227	8	9.8	4
<i>SY</i>	0.1281	7	-9.7	6
<i>SM</i>	0.1446	6	0	11
<i>PY</i>	0.2896	3	-33.5	1
<i>PM</i>	0.2315	5	-1.2	10
<i>RT</i>	0.1222	9	14.7	3
<i>ST</i>	-0.2402	4	-7.8	8
<i>PT</i>	0.3971	2	-32.2	2
<i>SoilM</i>	-0.0116	11	-9.7	6
<i>BP</i>	0.0840	10	-2.2	9

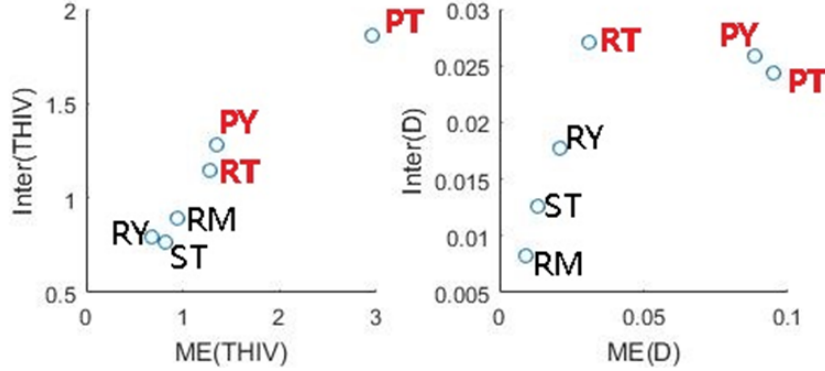

Figure 16: ME and $Inter$: (a) $THIV(km/h)$ and (b) $D(m)$

The value of μ^* (eq.8) is used to calculate the main effect (ME) of the parameter, and large value of the standard deviation σ implies significant interaction effects ($Inter$) of a parameter. Considering ME and $Inter$ with both $THIV$ and D as criteria, the three variables PT , PY and RT are of significant influence on VRS performances (see Fig.16).

4.4. Quantitative analysis—Sobol' indices

3 variables out of 11 were identified as of great influence on VRS performances after the screening analyses. Sobol' indices are calculated to quantify influences of the three variables — PT , PY and RT : 100 model runs were realized with samples taken by LHS; the Kriging metamodel was created and then validated with 20 additional samples; The Sobol' indices were calculated with the metamodel. The scatter plots of simulation results are given in Fig.17 : $THIV$ has positive correlation with PT & PY , while deformation of the device D has negative correlation with the input values. Correlations between RT and the output criteria are not evident, especially for $THIV$.

The Sobol' indices of inputs parameters are plotted in Fig.18 . The quantitative analysis results show that among the three parameters: the variance of post thickness (PT) is the most influential parameter for VRS performances (with $S_{PT} = 0.6069$, $ST_{PT} = 0.6311$ for $THIV$ and $S_{PT} = 0.529$, $ST_{PT} = 0.5583$ for D); uncertainties of post yield strength (PY) also play an important role for VRS robustness (with $S_{PY} = 0.3283$, $ST_{PY} = 0.3534$ for $THIV$ and $S_{PY} = 0.3762$, $ST_{PY} = 0.3903$ for D); relative to the other two parameters, the influences of rail thickness (RT) is negligible (with $S_{RT} = 0.0648$, $ST_{RT} = 0.0695$ for $THIV$ and $S_{RT} = 0.0948$, $ST_{RT} = 0.0890$ for D). For all the three variables, their main effects are approximately equal to their total effects, which indicate that there are nearly no interactions effects.

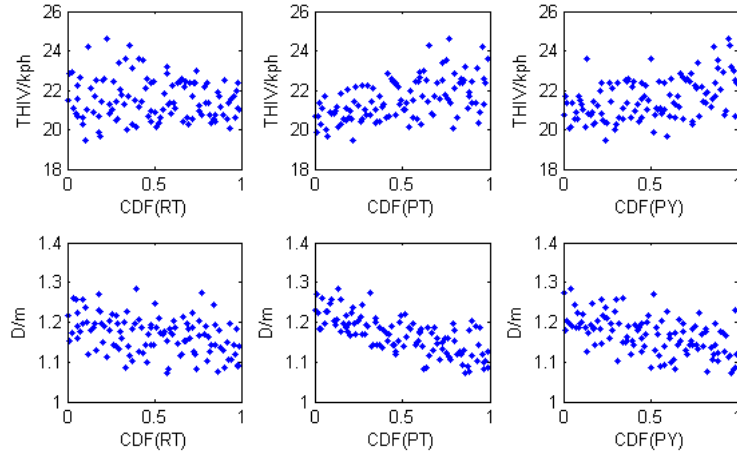

Figure 17: Scatter plots of $THIV$, D in function of the CDF values of inputs RT , PT , PY

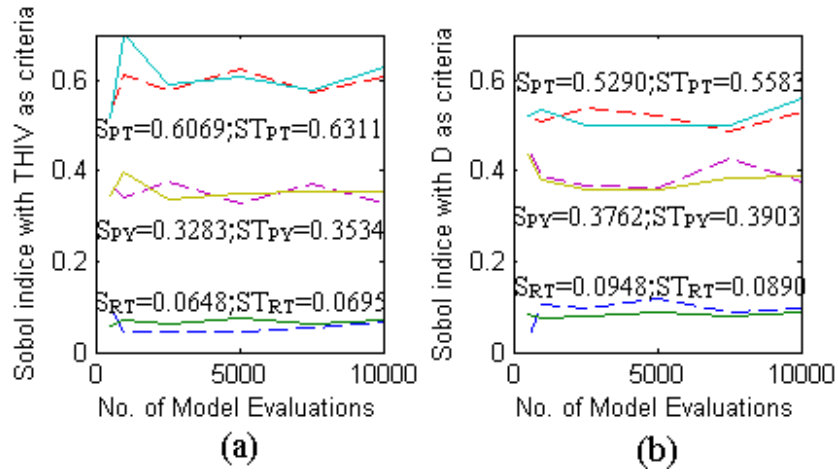

Figure 18: Evolution of Sobol' indices against the sample data size: (a) $THIV$; (b) D (Solid line: total effects of $PT(S_{PT})$, $PY(S_{PY})$ and $RT(S_{RT})$; Dotted line: main effects of $PT(S_{PT})$, $PY(S_{PY})$, $RT(S_{RT})$)

5. Conclusions

Uncertainties can significantly degrade the performances of engineering systems. SA helps to identify the few key factors that contribute to the robustness of a design. Approaches for SA of complex engineering systems are discussed and the SA of a VRS were carried out combining screening analyses and Sobol' indices:

- For SA of the VRS and many other complex models, screening analysis is needed before quantitative analysis in order to identify the influential uncertain parameters. By taking samples at multi-level, MA is one of the most commonly used screening methods as it can analyze qualitatively both the main effect and the interaction effects of an uncertain parameter, whatever the linearity or monotonicity of the model. The samples required for MA are still enormous for models of high simulation cost and with large number of uncertain parameters. In addition, influences of a non-influential parameter may be overestimated because of numerical errors in modeling & simulation process with MA. Two-level OA screening helps to identify the non-influential uncertain parameters with the least number of model runs, and the influences of numerical errors on SA of the model are offset by running the model multiple times with every uncertain parameter at each level. Performances of a model have monotonous relationship with the values of its uncertain parameters in many engineering problems, two-level OA screening can be used as the first step for SA of such models.
- The SA of a VRS is realized by combining two-level OA screening, MA and Sobol' indices: the crash test FE model is created and simplified considering deformations of the VRS & vehicle components; eleven uncertain parameters were selected; PY , PT , RT were identified as influential after two-level OA screening and MA; Kriging metamodeling was used to calculate Sobol' indices of the selected three parameters. The two most influential parameters, tolerance of the Post Thickness (PT) and the uncertainties of Post material Yield strength (PY), are identified after the sequential SA.

Performance of the VRS must be evaluated before being installed on the road side. Crash test result of a VRS provides a view of the VRS performance of only one set of parameters, and one cannot know how robust the design is because the repetition of crash tests is economically infeasible and the system uncertainties cannot be controlled.

FE simulation helps to realize the robustness analysis of VRS. "What makes modeling and scientific inquiry in general so painful is uncertainty" [1]. 'How to define the parameters with existence of uncertainties in the simulations' is one of the main questions that need to be considered in the FE modeling of engineering problems. SA of the VRS with FE simulations could, on the one hand, illustrate the performance dispersions (i.e. robustness) of a device instead of the single experimental crash test result. On the other hand, the critical parameters are

identified after the SA, which could greatly facilitate the definition of FE model parameters.

SA of the VRS provides useful instructions for its design: the most efficient way to increase model robustness is to decrease the fabrication tolerance of the Post Thickness; considering influences of the two influential uncertain parameters on the reliability of device instead of all the eleven, multi-objective robust optimization of the VRS has been realized in the other study [35].

Acknowledgements

This work is financed by the ‘China Scholarship Council’ under Certificate No. 201304490005. Experimental crash test of VRS was carried out by TRANSPOLIS. Prof. Jacquelin Eric, from LBMC and Dr. Goubel Clément, ex-researcher of TRANSPOLIS proposed useful suggestions for the research.

References

- [1] Saltelli A, et al. Sensitivity Analysis. Chichester: John Wiley & Sons; 2000
- [2] EN 1317: Road restraint systemsPart 1: terminology and general criteria for test methods; road restraint systemsPart 2: performance classes, impact test acceptance criteria and test methods for safety barriers including vehicle parapets. BSI Standards Publication, BS EN 1317-1,2:2010
- [3] Sicking DL, Mak KK, Rohde JR, Reid JD. Manual for assessing safety hardware. 1st ed. Washington, D.C.: American Association of State and Highway Transportation Officials; 2009
- [4] LSTC. LS-DYNA keyword user’s Manual, Volume I, Rev 8752. Livermore Software Technology Corporation; 2017. Version R10.0
- [5] LSTC. LS-DYNA keyword user’s Manual. Material models Volume II. Rev 8728. Livermore Software Technology Corporation; 2017. Version R10.0
- [6] Gutowski M, Palta E, Fang H. Crash analysis and evaluation of vehicular impacts on W-beam guardrails placed on sloped medians using finite element simulations. *Adv Eng Softw* 2017; 112: 88-100
- [7] Gutowski M, Palta E, Fang H. Crash analysis and evaluation of vehicular impacts on W-beam guardrails placed behind curbs using finite element simulations. *Adv Eng Softw* 2017; 000: 1-13
- [8] Hou S, et al. Optimization design of corrugated beam guardrail based on RBF-MQ surrogate model and collision safety consideration. *Adv Eng Softw* 2014; 78: 28-40
- [9] Yin H, Xiao Y, Wen G, Fang H. Design optimization of a new W-beam guardrail for enhanced highway safety performance. *Adv Eng Softw* 2017; 112: 154-64

- [10] Helton J.C, Johnson J.D, Salaberry C.J, Storlie C.B (2006) Survey of sampling based methods for uncertainty and sensitivity analysis. *Reliab Eng Syst Safe* 2006;91:1175-209
- [11] Meloni C, Dellino G. *Uncertainty management in Simulation-Optimization of Complex Systems: Algorithms and Applications*. Springer-Verlag; 2015
- [12] De Rocquigny E, Devictor N, Tarantola S. *Uncertainty in industrial practice*. John Wiley & Sons; 2008
- [13] Saporta G. *Probabilits, analyse de donnes et statistique*. Editions TECHNIP; 2006
- [14] Saltelli A, et al. *Global Sensitivity Analysis—The Primer*. New York: John Wiley & Sons; 2008
- [15] Hedayat A.S, Sloane N.J.A, Stufken J. *Orthogonal Arrays: Theory and Applications*. New York: Springer-Verlag; 1999
- [16] Morris M.D. Factorial sampling plans for preliminary computational experiments. *Technometrics* 1991;33:161-74
- [17] Campolongo F, Cariboni J, Saltelli A. An effective screening design for sensitivity analysis of large models. *Environ Model Softw* 2007;22:1509-18
- [18] Sobol I.M. Global sensitivity indices for nonlinear mathematical models and their Monte Carlo estimates. *Math Comput Simul* 2001;55:271-80
- [19] Saltelli A, et al. Variance based sensitivity analysis of model output. Design and estimator for the total sensitivity index. *Comput Phys Commun* 2010;181:259-70
- [20] Marrel A, et al. Calculations of Sobol indices for the Gaussian process metamodel. *Reliab Eng Syst Safe* 2009;94:742-51
- [21] Ryu J, et al. Kriging interpolation methods in geostatistics and DACE model. *KSME Int J* 2002;16:619-32
- [22] Goubel C, Massenzio M, Ronel S. Wood-steel structure for roadside safety barriers. *Int J Crashworthines* 2012;17:63-73
- [23] Murray Y.D. *Manual for LS-DYNA Wood Material Model 143*. Report No. Federal Highway Administration 2007;FHWAHRT-04-097
- [24] Melcher J, et al. Design characteristics of structural steels based on statistical analysis of metallurgical products. *J Constr Steel Res* 2004;60:795-808
- [25] Shan S, Wang G.G. Survey of modeling and optimization strategies to solve high-dimensional design problems with computationally-expensive black-box functions. *Struct Multidisc Optim* 2010;41:219-41

- [26] Lamoureux B, Mechbal N, Massé J. A combined sensitivity analysis and kriging surrogate modeling for early validation of health indicators. *Reliab Eng Syst Safe* 2014;130:12-26
- [27] Ge Q, Ciuffo B, Menendez M. Combining screening and metamodel-based methods: An efficient sequential approach for the sensitivity analysis of model outputs. *Reliab Eng Syst Safe* 2015;134:334-44
- [28] Oberkampf W.L, et al. Error and uncertainty in modeling and simulation. *Reliab Eng Syst Safe* 2002;75:333-57.
- [29] Goubel C, Massenzio M, Ronel S. Consideration of wood mechanical properties variation in roadside safety barriers design. *TRB Transportation Research Circular E-C172*; 2013
- [30] Kodjo V. Evaluation et modélisation des dispositifs de retenue pour motards. Dissertation, University Claude Bernard Lyon 1; 2016
- [31] Yan S, et al. Sensitivity Analysis of Guardrail Impact Parameters Based on Deflection Index. *Modern Transportation* 2014;3:1-7
- [32] LIER-TRANSPOLIS. GS2 hard shoulder W-beam guardrail TB32 experimental test report 2007
- [33] Qian G, Massenzio M, Ichchou M. Development of a W-Beam Guardrail crashing model by considering the deformations of components, in: *Proceeding of ICMCE '16*, Dec 14-17, 2016, Venice, Italy
- [34] Federal Highway Administration. Manual for LS-DYNA Soil Material Model 147 2004; report FHWA-HRT-04-095
- [35] Qian G, Massenzio M, Brizard D, Ichchou M. Multi-Objective and Non-deterministic Optimization of Vehicle Restraint Systems, in: *Proceeding of CFM '23*, Aug 28-Sep 1, 2017, Lille, France