



**HAL**  
open science

## Effects of sodium hypochlorite exposure mode on PES/PVP ultrafiltration membrane degradation

Christel Causserand, Bastien Pellegrin, Jean-Christophe Rouch

► **To cite this version:**

Christel Causserand, Bastien Pellegrin, Jean-Christophe Rouch. Effects of sodium hypochlorite exposure mode on PES/PVP ultrafiltration membrane degradation. *Water Research*, 2015, 85, pp.316-326. 10.1016/j.watres.2015.08.028 . hal-01906224

**HAL Id: hal-01906224**

**<https://hal.science/hal-01906224>**

Submitted on 26 Oct 2018

**HAL** is a multi-disciplinary open access archive for the deposit and dissemination of scientific research documents, whether they are published or not. The documents may come from teaching and research institutions in France or abroad, or from public or private research centers.

L'archive ouverte pluridisciplinaire **HAL**, est destinée au dépôt et à la diffusion de documents scientifiques de niveau recherche, publiés ou non, émanant des établissements d'enseignement et de recherche français ou étrangers, des laboratoires publics ou privés.



OATAO is an open access repository that collects the work of Toulouse researchers and makes it freely available over the web where possible

This is an author's version published in: <http://oatao.univ-toulouse.fr/20573>

Official URL: <https://doi.org/10.1016/j.watres.2015.08.028>

**To cite this version:**

Causserand, Christel<sup>✉</sup> and Pellegrin, Bastien<sup>✉</sup> and Rouch, Jean-Christophe<sup>✉</sup> *Effects of sodium hypochlorite exposure mode on PES/PVP ultrafiltration membrane degradation*. (2015) *Water Research*, 85. 316-326. ISSN 0043-1354

Any correspondence concerning this service should be sent to the repository administrator: [tech-oatao@listes-diff.inp-toulouse.fr](mailto:tech-oatao@listes-diff.inp-toulouse.fr)

# Effects of sodium hypochlorite exposure mode on PES/PVP ultrafiltration membrane degradation

Christel Causserand <sup>a, b, \*</sup>, Bastien Pellegrin <sup>a, b</sup>, Jean-Christophe Rouch <sup>a, b</sup>

<sup>a</sup> Université de Toulouse, INPT, UPS, Laboratoire de Génie Chimique, 118 route de Narbonne, F-31062 Toulouse cedex 09, France

<sup>b</sup> CNRS, UMR 5503, Laboratoire de Génie Chimique, F-31062 Toulouse, France

---

## A B S T R A C T

Drinking water production plants using membrane filtration processes report membrane failure issues. According to the literature, membrane degradation is often induced by exposure to sodium hypochlorite, an oxidant widely used during in-place cleanings. The present study focused on quantifying the effect of membrane exposure mode to hypochlorite on properties modifications of a PES/PVP ultrafiltration membrane widely used for drinking water production. For this purpose effects of sodium hypochlorite concentration, contact duration and exposure mode (static or dynamic) were investigated. The pH of the hypochlorite solution was set to 8 as it was demonstrated in numerous previous works that the pH range 7–8 leads to the most severe modification in the membrane characteristics. Membrane degradation was monitored at molecular scale by attenuated total reflectance infrared spectroscopy and at macroscopic scale by pure water permeability and elongation at break measurements. The results obtained in static (soaking) and dynamic (filtration and filtration/backwashing cycles) hypochlorite exposure modes indicated that PES/PVP membrane degradation progress was predominantly governed by hypochlorite oxidation rate. In the tested conditions, mechanical stress (pressure differentials) did not significantly contribute to membrane ageing. The correlation between molecular and macroscopic characterizations demonstrated that PVP degradation is responsible for the membrane integrity loss. A linear relationship between the loss of ductility of the membrane and the progress of the PVP degradation was obtained whatever the exposure mode. Thanks to experiments conducted at various hypochlorite concentrations and exposure durations, the hypochlorite dose parameter (hypochlorite concentration times contact time), widely used in the literature, was demonstrated to be inappropriate to describe the degradation rate: the hypochlorite concentration impact was shown to be dominating the exposure time's one on the degradation rate.

---

## 1. Introduction

During the past decade, ultrafiltration has become extensively used in the production of high quality drinking water. However, it is now well established that fouling, resulting from reversible and irreversible adsorption, the accumulation and cake build-up of water matrix components at the membrane surface, is one of the major drawbacks of membrane filtration processes. As a consequence, for on-site operations, membranes are periodically subjected to cleaning procedures using mostly sodium hypochlorite as

oxidizing agent during back-washing and chemical cleaning (Porcelli and Judd, 2010). However, organic membranes are sensitive to chemical exposure and to mechanical stress and numerous works have been dedicated in the last years to the study of membrane properties changes due to contact with hypochlorite. Depending on the characteristics of the treated water, water treatment facilities operators may use *NaOCl* solutions with a hypochlorite concentration up to 20 ppm for up to 5 min for back-washing process and with a concentration up to 400 ppm for up to 2 h for chemical cleaning process. Back-washing and chemical cleaning may respectively take place every 6 h and once per month of membrane operation. Even if membranes are only periodically in contact with hypochlorite, the combined amount of *NaOCl* in contact with membranes can be expressed as a total dose commonly calculated in ppm h. Hypochlorite exposure dose will then refer to

the concentration of the *NaOCl* solution, multiplied by the sample-*NaOCl* exposure time.

According to the exposure dose definition, increasing the hypochlorite concentration and reducing the total exposure time can be a direct way to perform accelerated experiments at lab scale and to predict the impact of hypochlorite on membranes during on-site operation. Two assumptions are then implicitly made: (1) degradations induced by intermittent hypochlorite exposures over a long period of time are additive and (2) the progress of degradation is only governed by the hypochlorite dose to which membranes are exposed. The validity of the hypothesis (2), commonly accepted, is however far from being trivial and needs to be checked for different hypochlorite concentrations. Only a few publications have already been dedicated to this question. One of the most significant is that of [Abdullah and Berube \(2013\)](#). These authors showed that the duration of hypochlorite cleaning had a greater impact on the replacements of membranes made of a blend of PVDF and hydrophilic additives than the concentration of hypochlorite solution, and proposed a new form for the dose relationship. [Regula et al. \(2013\)](#) also concluded on the non-accuracy of the dose concept as a representative tool to predict polysulfone membrane ageing. One of the main differences in the protocol followed in these two studies is the control of the hypochlorite solution pH: [Abdullah and Berube \(2013\)](#) kept it constant at 10 and [Regula et al. \(2013\)](#) did not control it. The pH is an important parameter as it controls *HClO* (weak acid) and *ClO<sup>-</sup>* (conjugate base) species dissociation in the hypochlorite solution (pKa value of 7.58 at 20 °C; [Carrell Morris, 1966](#)). It has been demonstrated by several authors that hypochlorous acid *HClO* is the form of chlorine whose presence is necessary so as to observe the degradation of membrane material such as polysulfone ([Rouaix et al., 2006](#)), polyamide ([Gabelich et al., 2005](#)) and polyethersulfone blended with hydrophilic Poly(N-vinylpyrrolidone) (PES/PVP membrane; [Pellegrin et al., 2013b](#)). PH then monitors the oxidative power of the hypochlorite solution on these membrane materials. In different contexts, it is well-known that *HClO* species are much more effective disinfectants with a higher oxidizing power in comparison to *ClO<sup>-</sup>* ([White, 1999](#)). As a consequence, and in order to validate or not the similarity between exposures at high concentration for short times, and low concentration for long times, we considered necessary to keep the same pH value in both exposure modes, whatever the degradation mechanism involved.

Moreover at lab scale various exposure modes (static or dynamic) can be considered. Most of studies on membranes ageing aimed at characterizing the chemical degradation due to their static contact with an oxidizing agent. In this context, works already published on PES based membranes, material often used in ultrafiltration processes dedicated to water treatment and selected in the present study, overall agree on the properties changes subsequent to membrane exposure to hypochlorite. The general trends are an increase in permeability ([Arkhangelsky et al., 2007b](#); [Yadav and Morison, 2010](#); [Pellegrin et al., 2013a,b](#)), accompanied by a deterioration of selectivity ([Arkhangelsky et al., 2007b](#); [Levitski et al., 2011](#); [Pellegrin et al., 2015](#)) and an embrittlement of the membrane ([Thominette et al., 2006](#); [Arkhangelsky et al., 2007a](#); [Yadav et al., 2009](#); [Pellegrin et al., 2013a,b](#)). The main mechanism involved in the membrane degradation when PES is blended with PVP as hydrophilic agent has been demonstrated to be PVP radical oxidation mainly by hydroxyl free radicals  $HO^\bullet$  and dislodgment from the PES matrix ([Prulho et al., 2013](#); [Pellegrin et al., 2013b](#)). It was shown that pH was then of crucial importance with maximum membrane degradation in the range 7–8 corresponding to the maximum radicals  $HO^\bullet$  concentration in hypochlorite solution.

The bibliography relating to membranes damage under

mechanical stress is much more limited. Pressure differentials may reasonably induce a degradation of membrane material but very little information is available on this subject.

We can mention the work published by [Childress et al. \(2005\)](#) on the influence of porous structure of the membrane and of module potting technique. It was shown in this study that, under equivalent constraints, asymmetric fiber has a greater propensity of failure than a symmetrical one. On the other hand, a simulation of the stress and displacement suffered by fibers within a module (using the ADINA-finite element analysis software) highlighted the stress concentrations that can result in a higher failure probability at potting/fiber interface.

One of the main studies combining chemical degradation and mechanical stress was published by [Zondervan et al. \(2007\)](#). This work aimed at determining the influence of four factors on the mechanical integrity of PES UF hollow fiber. The parameters tested were fouling status of the membrane, cleaning agent concentration (hypochlorite from 0 to 1000 ppm), magnitude of the back pulse and number of applied back pulses. The results showed that the fouling status of the membrane, the number of applied pulses and the combination of these two factors influenced membrane integrity significantly. On the other hand, membrane properties were not significantly affected by sodium hypochlorite concentration and the pressure pulse magnitude. These results allowed to highlight a mechanical damage that could be assimilated to a fatigue phenomenon of the polymer matrix. However it is important to note that in this study hypochlorite exposures were conducted at pH 11.5 and it was established by the previously discussed studies ([Begoïn et al., 2006](#); [Yadav et al., 2009](#); [Pellegrin et al., 2013a](#)) that, in this pH range, PES based membranes do not undergo significant degradation in contact with hypochlorite. A study at pH 8 would have allowed to highlight a possible combined effect of chemical degradation and mechanical damage.

The present study focused on quantifying the effect of membrane exposure mode to sodium hypochlorite on properties modifications of the PES/PVP ultrafiltration membrane selected for this work. In this purpose effects of sodium hypochlorite concentration, contact duration and exposure mode (static or dynamic) were investigated. The pH of the hypochlorite solution was set to 8 as it was demonstrated in numerous previous works that the pH range 7–8 leads to the most severe modification in the membrane characteristics. A discussion was then proposed concerning the accuracy of the commonly used relationship *Hypochlorite concentration times Exposure time* defined as exposure dose  $d_{NaOCl}$  to compare on site ageing and accelerated ageing at laboratory scale.

## 2. Material and methods

### 2.1. Membranes

This study was performed using virgin commercial hollow fiber membranes made of a blend of PES and PVP as hydrophilic additive. These membranes were extracted from an Ultrafiltration module (HYDRACAP 60, LD HYDRANAUTICS Membrane) widely used for drinking water production. Characteristics provided by the manufacturer are as follow: a molecular weight cut-off (MWCO) of 150 kDa, a maximum operating trans-membrane pressure (TMP) of 0.14 MPa and a maximum chlorine exposure of 200,000 ppm h.

After extraction from the module, the hollow fibers were stored in a 1 g L<sup>-1</sup> sodium bisulfite (Na<sub>2</sub>O<sub>4</sub>S<sub>2</sub> – Technical grade 85%, Sigma–Aldrich, USA) solution at 5 °C to avoid bacterial proliferation. Prior to using, membrane samples were soaked in a large volume of ultra-pure water for a minimum time of 1 h to remove sodium bisulfite.

## 2.2. Solutions

All aqueous solutions were prepared using deionized ultrapure water ( $\rho = 18.2 \text{ M}\Omega \text{ cm}$ ) generated by a PURELAB Maxima system (ELGA LabWater's, UK). Hypochlorite solutions used for ageing experiments were obtained by dilution of a commercial  $\text{NaOCl}$  reagent ( $\text{NaOCl}$  9.8 wt% – La Croix, FR). Total free chlorine concentration (TFC) was monitored using the so called DPD method (EPA-approved method 4500 Cl G): reaction of chlorine-containing samples with N,N-diethyl-p-phenylenediamine sulphate in the presence of a specific buffer producing a pink colored compound, measured at 520 nm using a spectrophotometer (DR/2400, HACH, USA). Concentrated sulfuric acid ( $\text{H}_2\text{SO}_4$  – Analytical grade 95%, VWR PROLABO, FR) was added to the hypochlorite ageing solutions to adjust their pH to 8.

## 2.3. Ageing protocols

### 2.3.1. Static soaking

The first ageing procedure consisted in soaking without stirring the membranes at ambient temperature ( $20 \pm 2 \text{ }^\circ\text{C}$ ) in hypochlorite solutions at a total free chlorine (TFC) concentration of 350 ppm ( $\text{mg L}^{-1}$ ). This concentration has been chosen as it corresponds to the order of magnitude of the maximum concentration to which membranes are potentially subjected during chemical cleaning on drinking water production plant. Exposure times ranged from 24 h to 144 h. The pH of the soaking solutions was adjusted to 8.

### 2.3.2. Ageing in dynamic conditions (continuous filtration and filtration/backwashing cycles)

To get closer than the industrial on-site conditions of membranes sodium hypochlorite exposure, a pilot presented in Fig. 1 allowing filtration and back washing cycles has been developed.

This pilot allows to filter a solution in tangential mode in 5 modules in parallel. Each module, 1.2 m in length, consists in a polyvinyl chloride (PVC) tube in which 15 fibers, potted with an epoxy resin were introduced. The transmembrane pressure  $\text{TMP}_f$  and the retentate flow rate  $Q_R$  are adjustable (filtration mode). After a predefined filtration duration, a system of valves allows to reverse the direction of filtration from the outside to the inside of the membrane, this time in dead-end and with a controlled pressure  $\text{TMP}_{bw}$  (backwashing mode). These two modes rotation allows to submit membranes to filtration/backwashing cycles.

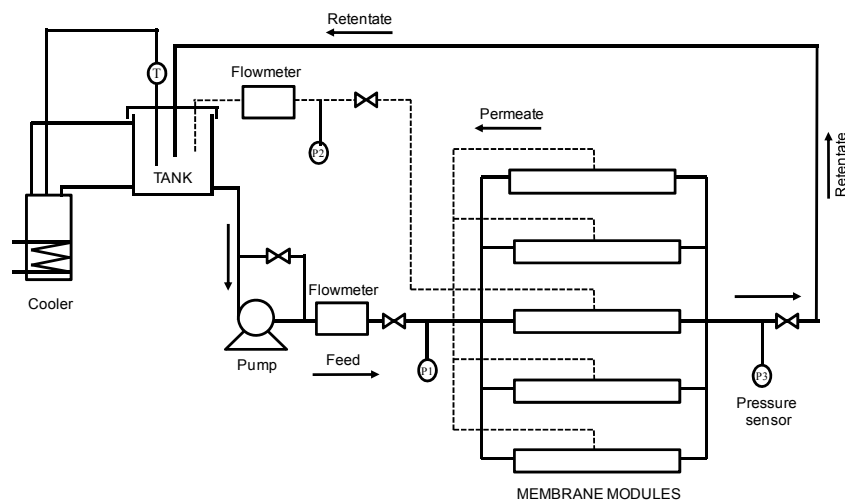

Fig. 1. Filtration pilot.

Two types of experiments were performed. As a first step, membranes were only subjected to continuous tangential filtration. The application of a constant  $\text{TMP}_f$  led to the application of constant mechanical stress on the membrane, and creep phenomenon can then potentially be detected. The impact of continuous tangential filtration was evaluated for a  $[\text{TFC}] = 350 \text{ ppm}$  at pH 8. In a second step, we applied a set of filtration at  $\text{TMP}_f$ /backwashing at  $\text{TMP}_{bw}$  cycles. This procedure is comparable to mechanical constraints cycles that could lead, in the long term, to a fatigue phenomenon of membrane material. The impact of the application of cycles was evaluated for hypochlorite solutions at pH 8 with  $[\text{TFC}]$  117 ppm, 350 ppm and 1050 ppm.

The selected operating conditions were the following: retentate flow rate  $Q_R = 20 \text{ L h}^{-1}$ ; Reynolds number inside the fibers  $Re = 1800$ ;  $\text{TMP}_f = 0.10 \text{ MPa}$  and  $\text{TMP}_{bw} = 0.11 \text{ MPa}$ . In all experiments, the filtered solution temperature was maintained at  $20 \pm 1 \text{ }^\circ\text{C}$  thanks to the use of a double jacket tank connected to a water circulation cooler (WK 2 400, Lauda).

Fig. 2 shows an example of pressure profile saved during an ageing experiment including filtration/backwashing cycles.

Cycle periodicity was defined in the objective to reproduce conditions encountered on site by the membranes. On site, membranes are in contact with hypochlorite during backwashing and chemical cleaning. The most severe conditions of contact according information's provided by the operators are:

- backwashing:  $[\text{TFC}] = 20 \text{ ppm}$ ; duration 5 min; frequency: every 6 h
- chemical cleaning:  $[\text{TFC}] = 400 \text{ ppm}$ ; duration 2 h; frequency: once a month.

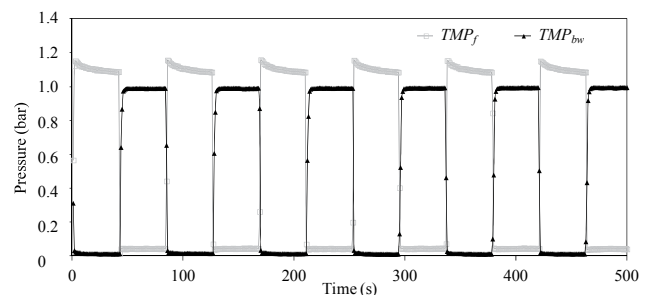

Fig. 2. Example of pressure profile applied during filtration/backwashing cycles.

It was then estimated that modules encounter 4 filtration/backwashing cycles per day. We therefore defined the duration of one cycle on the pilot so as at equivalent  $d_{NaOCl}$ , membranes encountered the same number of cycles on site and at laboratory scale. This gave us cycle durations of 126 s, 42 s and 14 s for hypochlorite solutions the [TFC] was respectively equal to 117 ppm, 350 ppm and 1050 ppm.

### 2.3.3. Soaking under stirring

As we can expect during ageing experiments a profile concentration of oxidizing species in the vicinity of the membrane surface due to their consumption by reaction with the material, an exposure mode under stirring was considered to evaluate the impact of the renewal by convection of the hypochlorite close to the membrane.

In this purpose, simultaneously to pilot experiments, membranes were also introduced in the feed tank containing the filtered hypochlorite solution. A systematic analysis of these membrane samples was conducted at various times of soaking. Thus we get also the results for submerged membranes in hypochlorite under stirring, because of the motion of the liquid in the circuit. Later in the paper we will call this type of ageing condition: "soaking under stirring". It is noted here that it was not the membranes that were in motion, but the liquid in which they were immersed.

Membrane control samples were similarly submitted to the various exposure modes described above in ultra-pure water. One more experiment was conducted in static condition using an acidic solution of  $H_2SO_4$  (0.1 M pH 0.8). This additional experiment using pure sulfuric acid was conducted in order to demonstrate that later the addition of such acid in hypochlorite solution in order to control the ageing solution pH didn't contribute to membrane ageing.

All the exposure modes investigated in this study were listed in Table 1.

After each ageing experiment, samples were soaked in a large volume of ultra-pure water for 2 h and stored in a 1 g L<sup>-1</sup> Na<sub>2</sub>O<sub>4</sub>S<sub>2</sub> solution at 5 °C for further analysis.

## 2.4. Membrane characterization

### 2.4.1. Permeability measurements

After ageing by soaking, a laboratory scale module comprising 15 fibers was manufactured (220 ± 5 mm length). Pure water permeability of pristine and hypochlorite aged membrane samples was quantified with a cross-flow filtration set-up at controlled temperature of 20 ± 5 °C. Ultra-pure water was forced to permeate from the inside to the outside of the module. To overcome the impact of membrane compaction, each module tested was first subjected to cross-flow filtration of ultra-pure water at maximal TMP of 0.14 MPa until pure water flux stabilization (20 min). After membrane compaction, the TMP was ranged from 0.05 to 0.14 MPa and taken as the average of the feed pressure and the retentate side

pressure readings, upstream of the pressure valve. The pure water permeability at 20 °C  $L_p/\mu_{20}$  in L h<sup>-1</sup> m<sup>-2</sup> bar<sup>-1</sup> (with  $L_p$  the permeability coefficient and  $\mu_{20}$  the water viscosity at 20 °C) was then taken as the slope value of the linear regression between  $\Delta P$  and  $J_{20}$  values according the Darcy law, as described in former work (Pellegriin et al., 2013a). After dynamic ageing (continuous filtration or cycles)  $L_p/\mu_{20}$  was directly measured using the filtration pilot (Fig. 1) after replacing hypochlorite by water in the circuit.

Finally we normalized the permeability  $L_p(t)/\mu_{20}$  measured on aged samples after an hypochlorite contact time of  $t$  by the one of the pristine membrane  $L_p(t0)/\mu_{20}$  and plotted in figures  $L_p(t)/L_p(t0)$ .

### 2.4.2. Tensile strain at break measurements

Tensile tests were performed on wet membranes using an INSTRON 3342 series tensile apparatus. Tailor-made grips for the hollow fiber geometry were fitted to the device to avoid stress concentration. Initial distance between grips was fixed to 110 mm and samples were extended at a constant elongation rate of 100 mm min<sup>-1</sup>. Elongation at break  $\epsilon_R$  was calculated from the experimental stress–strain curves.

### 2.4.3. Attenuated total reflection – fourier transform infrared (ATR-IR) spectroscopy

Infrared spectra of the inner active layer of membranes were recorded using a THERMO-NICOLET Nexus 670 fitted with a DTGS detector and a diamond ATR crystal. Spectra were obtained by summation of 16 scans between 4000 and 400 cm<sup>-1</sup> with a resolution of 4 cm<sup>-1</sup>. Spectral analysis was performed on OMNIC<sup>®</sup> software. Membrane samples were axially cut open to gain access to the inner active layer for analysis. Prior to analysis, samples were dried in a vacuum oven for 2 h at 50 °C and shortly stored in a desiccator. All the IR spectra recorded were corrected by adjusting the 1150 cm<sup>-1</sup> band (which corresponds to SO<sub>2</sub> symmetric stretching of PES and considered to be invariant during the membrane degradation) to an arbitrary chosen absorbance value of 1. To facilitate the reader's understanding, when monitoring changes of specific IR bands upon degradation, normalization back to the pristine membrane relative absorbance may be performed. The changes of the 1674 cm<sup>-1</sup> band (stretching vibration of the amide unit of the PVP) intensity were specifically studied. Indeed, it has been previously demonstrated that hypochlorite exposure induced PVP degradation and dislodgment from the PES matrix (Pellegriin et al., 2013b). Decrease in the intensity of the 1674 cm<sup>-1</sup> band is then a good indicator to quantify membrane degradation.

For tensile strain at break and ATR-IR measurements, a set of 8 samples was analyzed and averaged for each condition tested. Error bars plotted in figures represent standard deviation which overestimates of 16% the confidence interval for these 8 samples.

## 3. Results and discussion

As preliminary study, membrane control samples were first submitted to the various exposure modes using ultra-pure water. Under the conditions selected, the results obtained demonstrated that macroscopic properties (not shown here) and chemical structure (see Fig. 5(a)) of membranes were not affected by the application of a transmembrane pressure or by filtration/back filtration cycles when experiments were performed in ultrapure water. Moreover static soaking was conducted in acidic solution ( $H_2SO_4$  0.1 M pH 0.8) in order to verify the membrane material stability in contact with such chemical agent used to control pH of hypochlorite ageing solution. Membrane properties were not affected during this soaking over seven days of contact. Membrane degradation observed in the following sections can then be only attributed to hypochlorite action.

**Table 1**  
Experimental conditions investigated.

	Solution	Concentration	pH
Static soaking	$H_2O$	–	7.5
	$H_2SO_4$	0.1 M	0.8
	$NaOCl$	350 ppm	8
Soaking under stirring	$H_2O$	–	7.5
	$NaOCl$	117, 350 and 1050 ppm	8
Continuous Filtration	$H_2O$	–	7.5
	$NaOCl$	350 ppm	8
Filtration/back washing cycles	$H_2O$	–	7.5
	$NaOCl$	117, 350 and 1050 ppm	8

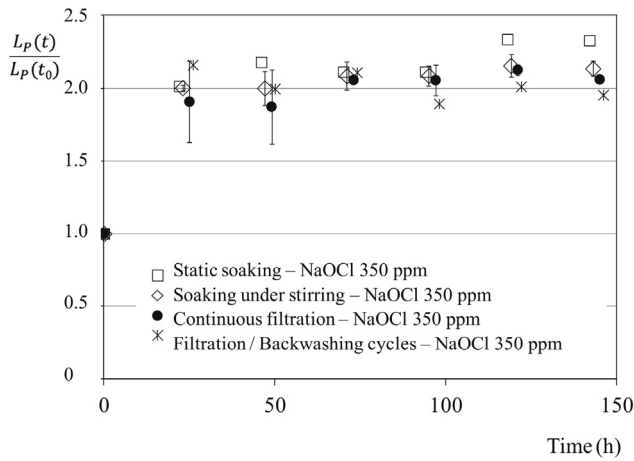

**Fig. 3.** Normalized permeability of membranes exposed to hypochlorite solution at  $[TFC] = 350 \pm 25$  ppm pH8 versus contact time and exposure mode.

### 3.1. Impact of hypochlorite exposure mode on membrane properties

In this section, we evaluated the effect of hypochlorite exposure mode on membrane properties: pure water permeability, mechanical resistance and surface chemistry. We compared over an experiment duration of 144 h the progress of membrane degradation in contact with a  $NaOCl$  solution of  $[TFC] = 350 \pm 25$  ppm, pH 8 in four different exposure modes:

- Static soaking
- Soaking under stirring
- Continuous tangential filtration at  $TMP_f = 0.10$  MPa
- Filtration/backwashing cycles: alternating periods of 42s of tangential filtration at  $TMP_f = 0.10$  MPa and backwashing at  $TMP_{bw} = 0.11$  MPa.

In Figs. 3–5 we have reported the evolution of water permeability, elongation at break  $\epsilon_R$  and  $1674\text{ cm}^{-1}$  band IR absorbance of membrane samples versus hypochlorite contact time as a function of exposure mode.

Whatever the exposure mode, we found as already published (Arkhangelsky et al., 2007b; Yadav and Morison, 2010; Pellegrin et al., 2013a,b) a sharp increase in permeability, which was

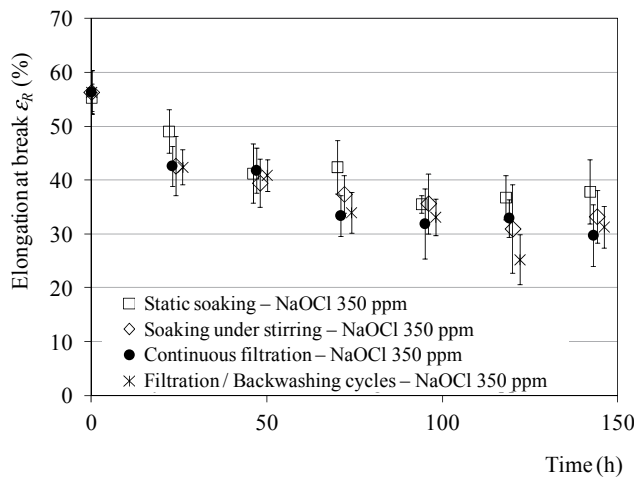

**Fig. 4.** Elongation at break of membranes exposed to hypochlorite solution at  $[TFC] = 350 \pm 25$  ppm pH8 versus contact time and exposure mode.

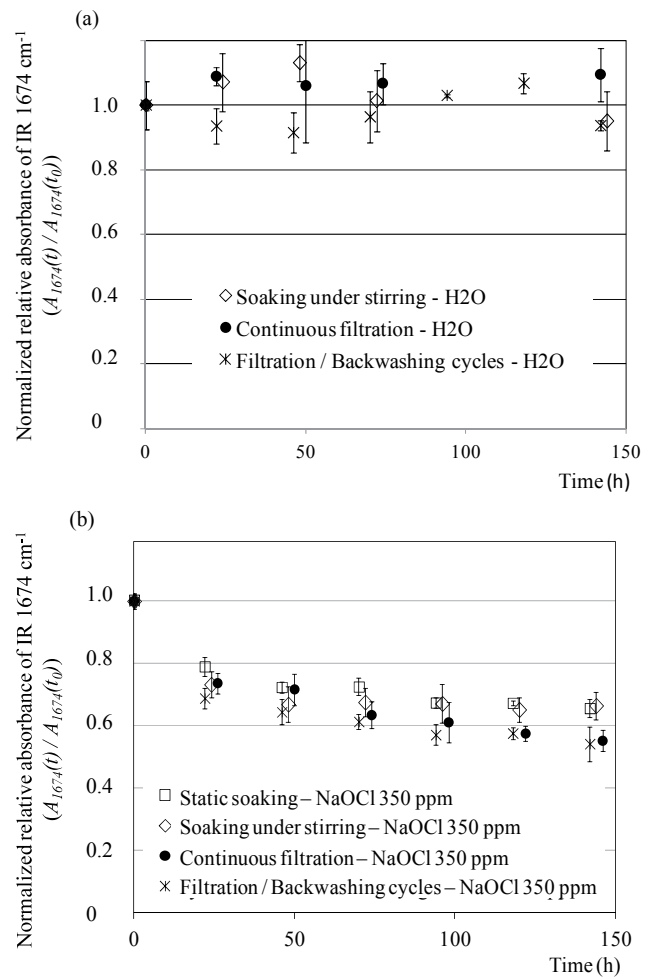
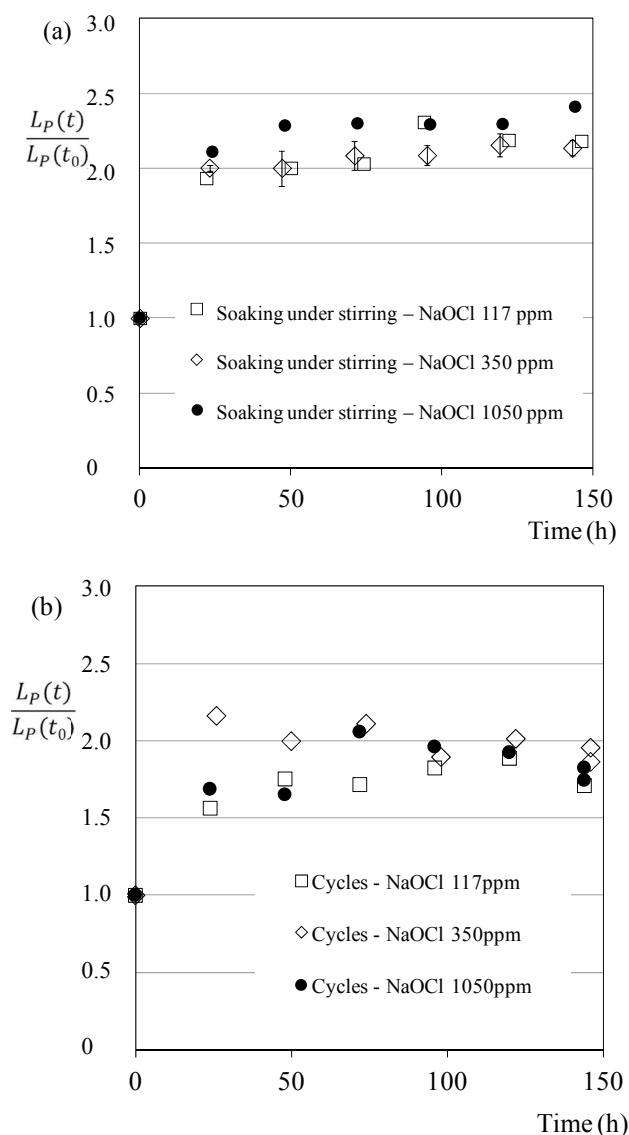

**Fig. 5.** Normalized relative IR absorbance of the  $1674\text{ cm}^{-1}$  band measured on membranes exposed to (a) water and (b) hypochlorite solution at  $[TFC] = 350 \pm 25$  ppm pH8 versus contact time and exposure mode.

multiplied by a factor 2 after 24 h of contact (Fig. 3). We can conclude in the conditions tested that sodium hypochlorite exposure mode didn't significantly impact on the evolution of the pure water permeability of membranes.

Fig. 4 shows that contact with  $NaOCl$  induced a significant decrease of elongation at break of membranes. This behavior is consistent with works already published (Thominette et al., 2006; Arkhangelsky et al., 2007a; Yadav et al., 2009; Pellegrin et al., 2013a,b). As for the changes in permeability previously reported, regardless of the mode of exposure, we found very similar behavior.

Changes of the  $1674\text{ cm}^{-1}$  IR band intensity attributed to the stretching vibration of the PVP amide unit were plotted in Fig. 5. Results obtained on membrane control samples exposed to ultra pure water (Fig. 5(a)) show almost no change, which demonstrates that PVP present in the membrane material was not dislodged from PES matrix over a prolonged period of contact with pure water, even when filtration and backwashing steps were conducted. On the other hand, similarly to the results obtained for macroscopic properties, regardless of the mode of exposure to hypochlorite, we observed in Fig. 5(b) similar changes in the PVP band. For all cases, this band decreased to approximately 60% of its initial value after 144 h of contact with  $NaOCl$ . As a conclusion, the renewal by convection of the oxidizing species close to the membrane (soaking with stirring experiment) didn't appear impacting the progress of degradation and the slight difference observed for long duration



**Fig. 6.** Normalized permeability of membranes exposed to hypochlorite solution pH 8 at various [TFC] versus contact time and exposure mode: (a) soaking under stirring (b) filtration/backwashing cycles.

experiments carried out by filtration or cycles was considered not enough significant to conclude at this stage to an effect of the application of a transmembrane pressure.

Under the conditions studied, we can therefore conclude to a limited influence on membrane degradation of the exposure mode during contact with a sodium hypochlorite solution at [TFC] = 350 ppm pH 8. When working at pH 11.5, Zondervan et al. (2007) concluded on the contrary to a more important effect of applied back pulses by comparison to sodium hypochlorite concentration. We can assume that these results were due to a low magnitude of chemical degradation of membrane material at pH 11.5 as already discussed in the introduction.

### 3.2. Influence of [TFC] on the progress of the degradation

In order, firstly, to explore a wide range of chemical degradation level, and to assess the validity of the dose concept, we conducted additional ageing experiments. These experiments were conducted for the same duration (144 h) as before in 2 exposure modes: soaking

under stirring and filtration/backwashing cycles in NaOCl solutions pH 8 at a concentration three times lower ([TFC] =  $117 \pm 8$  ppm) and three times higher ([TFC] =  $1050 \pm 75$  ppm) than the one selected so far.

In Figs. 6–8 we have reported the evolution of water permeability, elongation at break  $\epsilon_R$  and 1674  $\text{cm}^{-1}$  band IR absorbance of membrane samples versus hypochlorite contact time as a function of hypochlorite concentration ([TFC] = 117, 350 and 1050 ppm) and exposure mode: (a) soaking under stirring and (b) filtration/backwashing cycles.

No influence of [TFC] on the evolution of the pure water permeability was observed in Fig. 6. Indeed, even in the case of the lowest concentration ([TFC] =  $117 \pm 8$  ppm) and the lowest exposure duration (24 h), permeability already reached a maximum value around two times the initial one. As previously discussed by Pellegrin et al. (2013b) dislodgement of PVP from the membrane due to its degradation by hypochlorite may free up access to new pores and enlarge existing pores in the membrane active layer, leading to an increase of  $L_p/\mu_{20}$ . For the early stages of the degradation, results showed that the decrease of the PVP IR band corresponds to an increase of  $L_p/\mu_{20}$ , meaning that the PVP removal led to an increased active layer accessible porosity. As the degradation was more advanced,  $L_p/\mu_{20}$  reached a plateau. Assumption was made that beyond a given hypochlorite dose which seems to be rapidly reached at pH 8 in the range of [TFC] tested, the degradation and removal of the majority of the PVP accessible within the selective layer has occurred. This relatively stable state of the membrane skin thus led to stabilization of the water transfer properties.

Unlike the pure water permeability, we observed in Fig. 7 a significant difference in elongation at break evolution as a function of hypochlorite concentration. It appears a progressive embrittlement of the membrane all the more important the [TFC] was raised whatever the exposure mode. We also noticed in Fig. 7(c) whatever the hypochlorite concentration, most important embrittlement during the application of cycles compared to soaking under stirring.

In order to evaluate if this difference is statistically significant, mean values of elongation at break obtained in both exposure modes were compared using unilateral independent Student's *t* test. Two different levels of significance (P 0.05 and 0.15) were used for the statistical analysis, taken 7 as degree of freedom for the standard deviation. We considered that a P value less than 0.15 would still mean that the difference is significant.

Fig. 7(c) and P values associated to each couple of elongation at break measurements (during soaking and cycles) show that whatever the hypochlorite concentration, the difference observed between soaking and cycles experiments is significant beyond 48 h of contact.

Similarly to the embrittlement of the membranes, Fig. 8 shows that more [TFC] of the NaOCl solution at pH 8 was high, the more the PVP characteristic band was affected. We also noticed a significant difference although small between soaking under stirring and cycles.

As a conclusion, in both exposure modes investigated in this part of the study, [TFC] influenced the evolution of mechanical and chemical properties of the membrane during its contact with NaOCl solution at pH 8. More [TFC] was high, the more the magnitude of degradation was after 144 h exposure duration.

As it was already proposed by Pellegrin et al. (2013b) we can correlate the macroscopic properties to the molecular changes as the PVP degradation progress impacts the mechanical resistance of the overall membrane. Fig. 9 presents the changes of elongation at break  $\epsilon_R$  versus the PVP IR band relative absorbance normalized back to the pristine membrane value. A compilation of the data collected in the case of ageing by static soaking for a wide range of hypochlorite doses at pH 6, 8 and 11 (small points) was previously



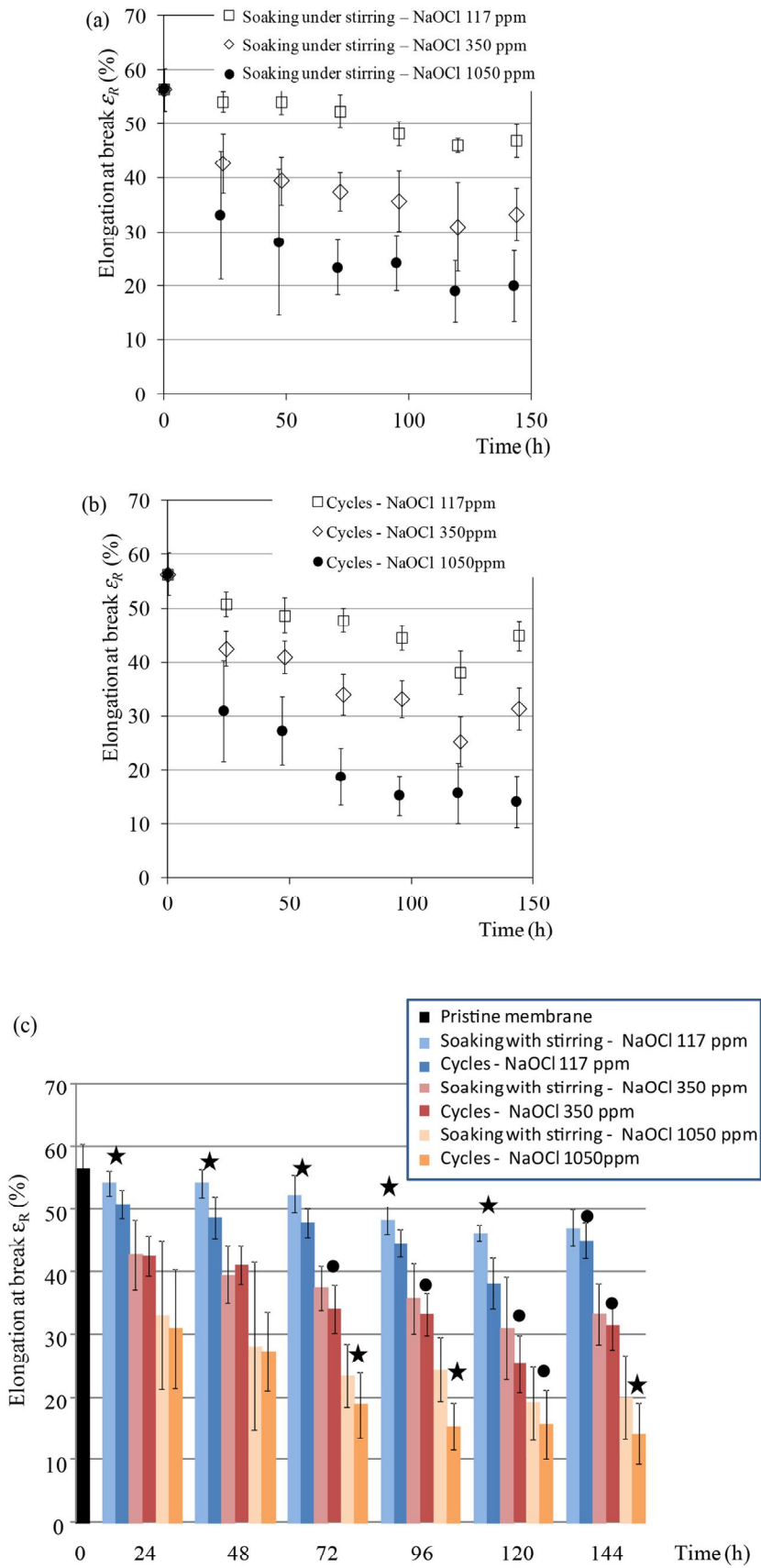

**Fig. 7.** Elongation at break of membranes exposed to hypochlorite solution pH 8 at various [TFC] versus contact time and exposure mode: (a) soaking under stirring (b) filtration/backwashing cycles (c) both exposure modes (significant difference between Soaking and Cycles: ★  $P < 0.05$  and ●  $P < 0.15$ ).

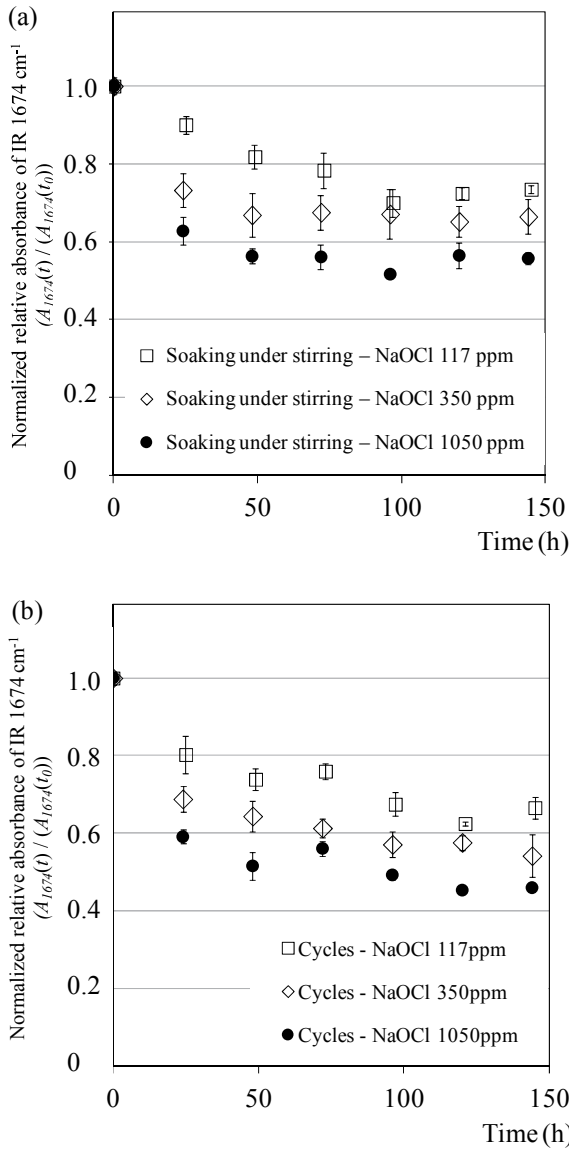
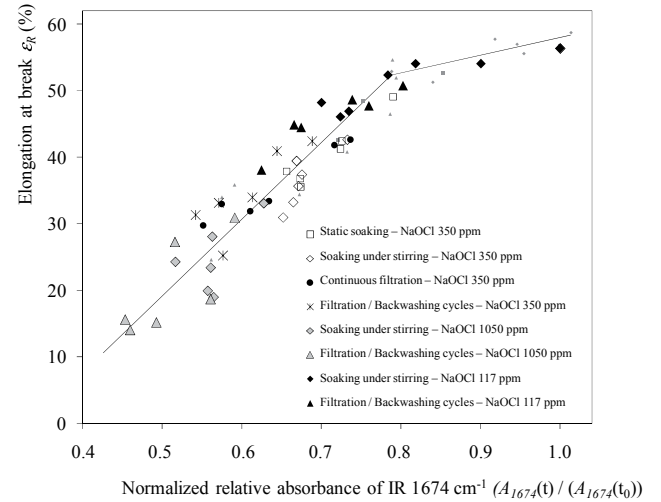

**Fig. 8.** Normalized relative IR absorbance of the 1674 cm<sup>-1</sup> band measured on membranes exposed to hypochlorite solution pH 8 at various [TFC] versus contact time and exposure mode: (a) soaking under stirring (b) filtration/backwashing cycles.

reported in a similar figure by Pellegrin et al. (2013b). We have superimposed here the results obtained in the present study at pH 8 by soaking under stirring, filtration and filtration/backwashing cycles, at the hypochlorite concentrations of 117 ppm, 350 ppm and 1050 ppm. This figure shows that whatever the exposure mode and the hypochlorite dose, mechanical properties of the membrane were not significantly altered until the intensity of the 1674 cm<sup>-1</sup> band reached 80% of its initial value. For lower intensity corresponding to more advanced PVP oxidation and/or removal, very severe decrease in elongation at break was observed. The correlation between the decrease of  $\epsilon_R$  of the membrane and the degradation progress of the PVP was therefore validated.

### 3.3. Hypochlorite dose concept

The majority of studies on ageing of ultrafiltration membranes induced by exposure to NaOCl used the concept of dose  $d_{NaOCl} = [TFC] t$  ([TFC] total free chlorine concentration and  $t$



**Fig. 9.** Elongation at break  $\epsilon_R$  versus normalized PVP IR band absorbance (1674 cm<sup>-1</sup>), for various hypochlorite exposure modes and [TFC] at pH 8. Small points correspond to static soaking for a wide range of hypochlorite doses at pH 6, 8 and 11 previously reported on this figure by Pellegrin et al. (2013b).

exposure time). For a number of works (Akhangel'sky et al., 2007a,b; Yadav et al., 2009; Yadav and Morison, 2010), the assumption was made that the degradation progress is governed by the hypochlorite dose to which membranes are subjected.

From the results presented in the previous section, we can assess the validity of this assumption. To do this, we have reported the values of elongation at break and relative intensity of the 1674 cm<sup>-1</sup> IR band measured on samples exposed to various [TFC] in both conditions by soaking under stirring and filtration/backwashing cycles, versus  $d_{NaOCl}$  (Fig. 10).

The weighting of the timescale by [TFC] led to the superimposition of values of elongation at break and 1674 cm<sup>-1</sup> IR band intensity for different ageing conditions. As a first approximation, this allows us to show graphically that in the range 117–1050 ppm at pH 8 the degradation progress seems to be controlled by the  $d_{NaOCl}$  to which membranes were subjected.

One can nevertheless point out that at equivalent  $d_{NaOCl}$  values obtained at low concentration were systematically slightly superior to those obtained at a higher one. For example, in the case of a soaking under stirring, for  $d_{NaOCl} = 50,400$  ppm h, we get decreases of the 1674 cm<sup>-1</sup> IR band intensity of  $34 \pm 4\%$  and  $44 \pm 2\%$  in [TFC] equals to 350 ppm and 1050 ppm respectively. We then assumed that [TFC] had a greater effect on membrane characteristics changes than exposure time to hypochlorite. In order to take into account this, we proposed to replace  $d_{NaOCl}$  with a modified dose  $d'_{NaOCl}$  reflecting respective contributions of [TFC] and exposure time through the relation:

$$d'_{NaOCl} = [TFC]t^n$$

By translating the evolutions of elongation at break and 1674 cm<sup>-1</sup> IR band intensity in power laws, we calculated the value of  $n$  for which the correlation coefficient ( $R^2$ ) was maximum.

Fig. 11 presents the results obtained by applying this correction to the data plotted in Fig. 10.

In the case of soaking under stirring, calculated  $n$  values to reach a maximum  $R^2$  were 0.56 and 0.58 for the evolution of  $\epsilon_R$  and the 1674 cm<sup>-1</sup> IR band respectively. Concerning ageing using filtration/backwashing cycles, we obtained values of  $n$  of 0.72 and 0.88. In all cases the average of the differences between mean experimental values and calculated ones using the  $n$  values defined above equals 5%.

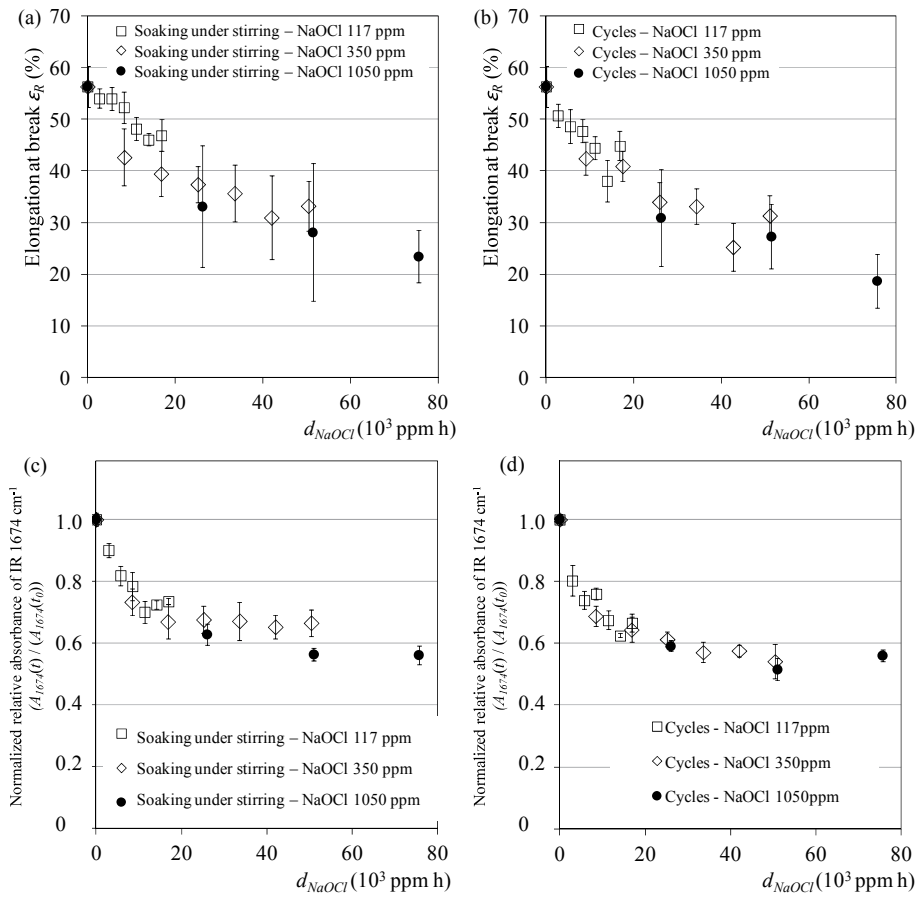

**Fig. 10.** Elongation at break (a and b) and normalized  $1674\text{ cm}^{-1}$  IR band absorbance (c and d) versus  $d_{NaOCl}$  for membranes exposed to NaOCl pH 8, [TFC] = 117, 350 and 1050 ppm by soaking under stirring or filtration/backwashing cycles.

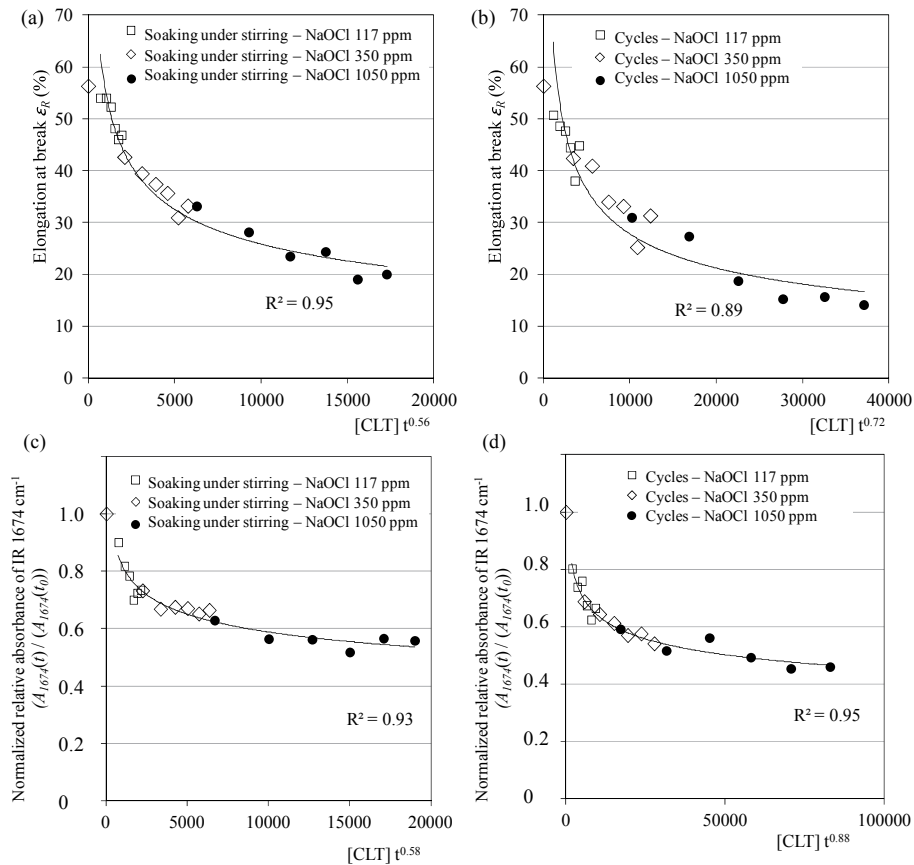

**Fig. 11.** Elongation at break (a and b) and normalized  $1674\text{ cm}^{-1}$  IR band absorbance (c and d) versus  $d_{NaOCl}$  for membranes exposed to NaOCl pH 8, [TFC] = 117, 350 and 1050 ppm by soaking under stirring or filtration/backwashing cycles.

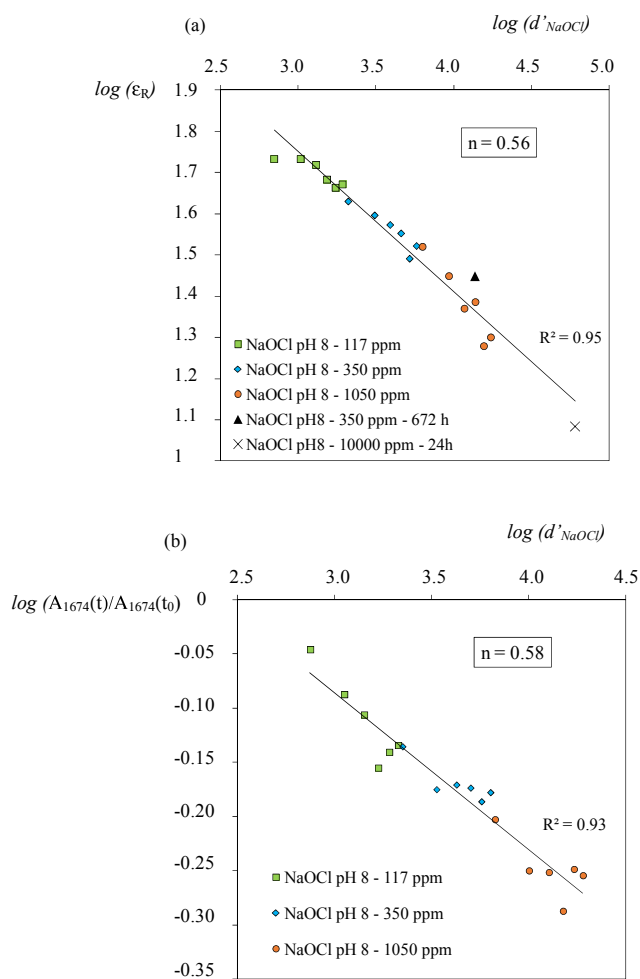

**Fig. 12.** Log–Log representation of elongation at break (a) and normalized 1674  $\text{cm}^{-1}$  IR band absorbance (b) versus  $d'_{NaOCl}$  for membranes exposed to NaOCl pH 8, [TFC] = 117, 350 and 1050 ppm by soaking under stirring. Extreme exposure dose ( $d_{NaOCl} = 240,000$  ppm h) were represented by  $\blacktriangle$  and X symbols in a.

All calculated  $n$  values were less than 1, it is therefore clear that, under the conditions tested in this study, hypochlorite concentration contributed mostly to the progress of the degradation.

On the other hand, we can notice that  $n$  values calculated in the case of soaking under stirring were lower than those obtained by applying cycles. This allows us to highlight a slight contribution of the application of a transmembrane pressure on the degradation progress already discussed on results reported Figs. 7 and 8.

As shown in Fig. 12 a convenient mode to plot the results was then a log–log representation leading to a linear evolution of elongation at break and normalized 1674  $\text{cm}^{-1}$  IR band absorbance versus  $d'_{NaOCl}$ . To demonstrate the validity of this relationship for extreme exposure doses, we have also plotted in Fig. 12(a) the results obtained during 2 additional experiments conducted at the maximum life time exposure dose specified by the manufacturer for this membrane which is 200,000 ppm h:

- [TFC] = 350 ppm, pH 8, 672 h:  $d_{NaOCl} = 235,200$  ppm h,
- [TFC] = 10,000 ppm, pH 8, 24 h:  $d_{NaOCl} = 240,000$  ppm h.

Abdullah and Berude (2013) have recently published work suggesting a correction of  $d_{NaOCl}$  similar to what we have just presented. Their study focused on the degradation by NaOCl ( $3600 \text{ ppm} \leq [\text{TFC}] \leq 44,300 \text{ ppm}$ ) of membranes made of a blend

of PVDF and an unknown hydrophilic additive. By reporting the evolution of physical/chemical properties of the membrane for different [TFC] and soaking times, they demonstrated that, in their case, contact time had a greater impact on membrane changes than did [TFC]. That is to say, for a fixed exposure dose, degradation was more advanced that the [TFC] was low and that the soaking time was long.

This leads us to point out that the relative influences of [TFC] and contact time setting  $d'_{NaOCl}$  are specific to a material and a range of NaOCl exposure modes. As a conclusion, the parameter  $n$  is material dependant and should be recalculated for any other system.

Moreover, at this stage, it is still difficult to establish a quantitative correspondence, through a dose of hypochlorite (modified or not), between degradation at laboratory scale and ageing on drinking water production plant. Intuitively, we might think that in absence of fouling step in the procedure (laboratory ageing), the degradation of membrane material would be most important. Indeed, during on-site operation, part of the oxidative species should be consumed by reaction with the organic matter deposited on the membrane. It is therefore reasonable to expect that the results presented in this paper overestimate ageing on site and hence correspond to the worst case.

#### 4. Conclusion

This paper proposes a study of the influence of the exposure parameters during the degradation of PES/PVP membranes in contact with sodium hypochlorite solutions.

A comparative study of the evolution of molecular and macroscopic markers of the degradation during the ageing of membranes subjected to pressure differentials suggested that membrane degradation was predominantly governed by hypochlorite oxidation rate. The application of a transmembrane pressure of 0.10 MPa during long term tangential filtration or filtration at 0.10 MPa/backwashing at 0.11 MPa during cycles led to a small change of the chemical oxidation progress caused by hypochlorite, visible only for advanced degradation state (beyond 48 h of contact). It is worth noting that the choice of such pressures was relevant with regards to the maximum pressure fixed by the manufacturer of the selected membrane which is 0.14 MPa.

It has been possible to correlate membrane macroscopic properties evolution to the degradation of PVP. More specifically, from a certain threshold of degradation (oxidation/PVP loss greater than 20% of the initial content) we highlighted a linear relationship between the loss of ductility of the membrane and the PVP degradation progress whatever the exposure mode. Although PVP represents only a proportion of less than 3% of the membrane material, its degradation directly induced the loss of mechanical resistance of the membrane.

The influence of the total free chlorine concentration on the progress of degradation was evaluated in a range of 117–1050 ppm with an extra experiment at 10,000 ppm. This study shows that the damages caused by extended exposure to various [TFC] may not directly be related to the dose of hypochlorite  $d_{NaOCl} = [\text{TFC}] t$  to which membranes were exposed. Indeed, a preponderant effect of concentration vs. time has been observed. In the ranges of concentration and time we studied, the evolution of molecular and macroscopic markers can be satisfactorily related to a modified dose  $d'_{NaOCl} = [\text{TFC}] t^n$ , whose value of  $n$  was between 0.56 and 0.88.

#### Acknowledgments

Financial support from the French National Research Agency is gratefully acknowledged (project n° ANR-09-BLAN-0055-01).

## References

- Arkhangelsky, E., Kuzmenko, D., Gitis, N.V., Vinogradov, M., Kuiry, S., Gitis, V., 2007a. Hypochlorite cleaning causes degradation of polymer membranes. *Tribol. Lett.* 28 (2), 109–116.
- Abdullah, S.Z., Bérudé, P.R., 2013. Assessing the effects of sodium hypochlorite exposure on the characteristics of PVDF based membranes. *Water Res.* 47, 5392–5399.
- Arkhangelsky, E., Kuzmenko, D., Gitis, V., 2007b. Impact of chemical cleaning on properties and functioning of polyethersulfone membranes. *J. Membr. Sci.* 305 (1–2), 176–184.
- Bégoïn, L., Rabiller-Baudry, M., Chaufer, B., Hautbois, M.C., Doneva, T., 2006. Ageing of PES industrial spiral-wound membranes in acid whey ultrafiltration. *Desalination* 192, 25–39.
- Carrell Morris, J., 1966. The acid ionization constant of HOCl from 5 to 35°. *J. Phys. Chem.* 70, 3798–3805.
- Childress, A.E., Le-Clech, P., Daugherty, J.L., Chen, C., Leslie, G.L., 2005. Mechanical analysis of hollow fiber membrane integrity in water reuse applications. *Desalination* 180, 5–14.
- Gabelich, C.J., Frankin, J.C., Geringer, F.W., Ishida, K.P., Suffet, I.H., 2005. Enhanced oxidation of polyamide membranes using monochloramine and ferrous iron. *J. Membr. Sci.* 258, 64–70.
- Levitsky, I., Duek, A., Arkhangelsky, E., Pinchev, D., Kadoshian, T., Shetrit, H., Naim, R., Gitis, V., 2011. Understanding the oxidative cleaning of UF membranes. *J. Membr. Sci.* 377, 206–213.
- Pellegrin, B., Gaudichet-Maurin, E., Causserand, C., 2013a. Mechano-chemical ageing of PES/PVP ultrafiltration membranes used in drinking water production. *Water Sci. Technol. Water Supply* 13.2, 541–551.
- Pellegrin, B., Prulho, R., Rivaton, A., Thérias, S., Gardette, J.L., Gaudichet-Maurin, E., Causserand, C., 2013b. Multi scale analysis of hypochlorite induced PES/PVP ultrafiltration membranes degradation. *J. Membr. Sci.* 447, 287–296.
- Pellegrin, B., Mezzari, F., Hanafi, Y., Szymczyk, A., Remigy, J.C., Causserand, C., 2015. Filtration performance and pore size distribution of hypochlorite aged PES/PVP ultrafiltration membrane. *J. Membr. Sci.* 474, 175–186.
- Porcelli, N., Judd, S., 2010. Chemical cleaning of potable water membranes: a review. *Sep. Purif. Technol.* 71, 137–143.
- Prulho, R., Thérias, S., Rivaton, A., Gardette, J.L., 2013. Ageing of polyethersulfone/polyvinylpyrrolidone blends in contact with bleach water. *Polym. Degrad. Stab.* 98.6, 1164–1172.
- Regula, C., Carretier, E., Wyart, Y., Sergent, M., Gesan-Guiziou, G., Ferry, D., Vincent, A., Boudot, D., Moulin, P., 2013. Ageing of ultrafiltration membranes in contact with sodium hypochlorite and commercial oxidant: experimental designs as a new ageing protocol. *Sep. Purif. Technol.* 103, 119–138.
- Rouaix, S., Causserand, C., Aimar, P., 2006. Experimental study of the effects of hypochlorite on polysulfone membrane properties. *J. Membr. Sci.* 277, 137–147.
- Thominette, F., Fanault, O., Gaudichet-Maurin, E., Machinal, C., Schrotter, J.C., 2006. Ageing of polyethersulfone ultrafiltration membranes in hypochlorite treatment. *Desalination* 200, 7–8.
- White, C.G., 1999. *Handbook of Chlorination and Alternative Disinfectants*, fourth ed. Wiley-Interscience Publication, U.S.A, pp. 212–287.
- Yadav, K., Morison, K.R., 2010. Effects of hypochlorite exposure on flux through PES UF membranes. *Food Bioprod. Process* 88, 419–424.
- Yadav, K., Morison, K., Staiger, M.P., 2009. Effects of hypochlorite treatment on the surface morphology and mechanical properties of PES UF membranes. *Polym. Degrad. Stab.* 94, 1955–1961.
- Zondervan, E., Zwijnenburg, A., Roffel, B., 2007. Statistical analysis of data from accelerated ageing tests of PES UF membranes. *J. Membr. Sci.* 300, 111–116.