



HAL
open science

Removal of iron using an oxidation and ceramic microfiltration hybrid process for drinking water treatment

Rahma Fakhfekh, Elodie Chabanon, Denis Mangin, Raja Ben Amar, Catherine Charcosset

► **To cite this version:**

Rahma Fakhfekh, Elodie Chabanon, Denis Mangin, Raja Ben Amar, Catherine Charcosset. Removal of iron using an oxidation and ceramic microfiltration hybrid process for drinking water treatment. *Desalination and Water Treatment*, 2017, 66, pp.210 - 220. 10.5004/dwt.2017.20225 . hal-01899789

HAL Id: hal-01899789

<https://hal.science/hal-01899789v1>

Submitted on 22 Oct 2024

HAL is a multi-disciplinary open access archive for the deposit and dissemination of scientific research documents, whether they are published or not. The documents may come from teaching and research institutions in France or abroad, or from public or private research centers.

L'archive ouverte pluridisciplinaire **HAL**, est destinée au dépôt et à la diffusion de documents scientifiques de niveau recherche, publiés ou non, émanant des établissements d'enseignement et de recherche français ou étrangers, des laboratoires publics ou privés.

Removal of iron using an oxidation and ceramic microfiltration hybrid process for drinking water treatment

Rahma Fakhfekh^{a,b}, Elodie Chabanon^b, Denis Mangin^b, Raja Ben Amar^a, Catherine Charcosset^{b,*}

^aLaboratoire des Sciences des Matériaux et de l'Environnement, Faculté des Sciences de Sfax, Université de Sfax, Tunisia, Tel. +216 222 83 848, email: recherche_de_rahma@yahoo.fr (R. Fakhfekh), Tel. +216 21 603 013, email: benamar.raja@yahoo.com (R.B. Amar)

^bUniversité de Lyon, F-69622, Lyon, France ; Université Lyon 1, Villeurbanne; LAGEP, UMR 5007, CNRS, CPE, 43 bd du 11 novembre, 69100 Villeurbanne, France, Tel. +33 0(4) 72 43 18 52, email: elodie.chabanon@univ-lyon1.fr (E. Chabanon), Tel. +33 0(4) 72 43 18 51, email: denis.mangin@univ-lyon1.fr (D. Mangin), Tel. +33 (0)4 72 43 18 34, email: charcosset@lagep.univ-lyon1.fr (C. Charcosset)

Received 20 June 2016; Accepted 10 September 2016

ABSTRACT

In this study, we investigated a hybrid oxidation/microfiltration (MF) process for the continuous treatment of water containing iron. Synthetic iron waters were continuously added to an aerated tank and filtered using a Kerasep ceramic membrane (Novasep, France) coupled to the aerated reactor. The iron removal and the filtration flux were measured for several parameters: pH and iron concentration of the feed solution and transmembrane pressure (TMP). The results obtained showed a very high iron removal whatever the conditions used, as well as a constant filtration flux versus time. It is suggested that the mechanisms of iron removal are related to steric rejection of the ferric hydroxide particles formed. The constant filtration flux suggested low membrane fouling which may be due to the large size of the ferric hydroxide particles. Dead-end filtration was also performed with acetate cellulose and polycarbonate membranes showing a strong effect of the membrane material. Finally, a groundwater from Gremda location (Sfax, Tunisia) was treated successfully since a quasi-constant permeate flux around 900 L/h·m² was obtained and a total iron removal was achieved.

Keywords: Groundwater; Iron removal; Membrane hybrid process; Microfiltration; Oxidation/aeration

1. Introduction

The production of safe drinking water is one of the major concerns of the XXI century due to the increase of the world population and the water consumption per person [1]. Nowadays, groundwater is one of the main sources of drinking water throughout the world. This source of water is generally in anoxic condition, i.e. devoid of dissolved oxygen, and slightly acid due to the presence of dissolved carbon dioxide. Iron is one of the most abundant elements in the earth's crust [2,3]. Consequently, due to the contact

of water with rocks and minerals, groundwater is often highly concentrated in ferrous iron, at levels ranging from 0.5 to 50 mg·L⁻¹. On exposure to the atmosphere, the ferrous iron oxidizes to ferric iron, giving a reddish-brown color to the water. Iron may also be present in drinking water due to the use of iron coagulants or the corrosion of steel and iron pipes during water distribution. Iron doesn't represent any danger for human health but could be responsible of unpleasantness taste, odour or colour as well as the development of microorganisms with serious consequences for the users, due to the growth of "iron bacteria" promoted by the oxidation of ferrous iron into ferric iron [2,3]. That is the reason why the World Health Organisation (WHO) rec-

*Corresponding author.

ommends that the concentration of ferrous iron in drinking water should not exceed 0.3 ppm [1].

Several operations are available to remove iron in water purification [3] amongst them: electro-coagulation [4], oxidation/filtration [5,6], ion exchange and water softening [7], adsorption on activated carbon and other filtration materials like ash and soil filter [8–11], biological treatment [12–14], and membrane processes [6,15,16].

The oxidation/filtration operation is traditionally used to remove iron from groundwater but admits several changes depending on the initial iron concentration. In this process, ferrous iron is oxidized into ferric iron which is precipitated into ferric hydroxide. Regarding the oxidation step, if the water exhibits an initial iron concentration typically higher than $5 \text{ mg}\cdot\text{L}^{-1}$, then aeration is sufficient for oxidizing ferrous iron and the costs of chemical products are avoided [17]. In the opposite case, oxidation can be carried out using a solid phase such as greensand or birm [18], chemicals (potassium permanganate, hypochlorite...) or dissolved gas (oxygen, chlorine, ozone, ...) [6,17]. The solid products of oxidation, especially the ferric hydroxide $\text{Fe}(\text{OH})_3$ particles, are then filtered mainly using a sand filtration operation. However, this conventional process works if the total iron concentration is typically below $5 \text{ mg}\cdot\text{L}^{-1}$ and in the absence of dissolved organic matter. For higher concentrations, excessive amounts of solids tend to shorten filtration cycles [6].

The oxidation of iron has been largely studied. Several authors [19,20] demonstrated that the presence of ferric hydroxide was responsible for a significant increase of the oxidation rate of the ferrous iron. Tufekci and Sarikaya [19] reported that the effect became noticeable at a concentration of $\text{Fe}(\text{III})$ higher than $5\text{--}10 \text{ mg}\cdot\text{L}^{-1}$. This effect was used for iron removal in a lab-scale continuous flow aeration/sedimentation unit with or without recycling [21]. In addition to the pH and the ferric hydroxide concentration, the oxidation rate of ferrous iron into ferric iron, is dependent on iron and oxygen concentrations, pH, temperature, organic matter and other ions present in the solution [17,20,22,23].

In order to improve the operation and remove high amounts of iron [12], several studies have been reported amongst them membrane technologies appear as a promising alternative to develop compact separation units able to produce high quality water from a wide range of raw water quality. However, ferric and ferrous ions are too small to be retained by nanofiltration (NF), ultrafiltration (UF) or microfiltration (MF) membranes; therefore iron based particles need to be formed before being filtrated. Iron based complexes can be obtained using chelating agents [24,25] or in the presence of humic acid [26]. For example, Lastra et al. [24] achieved complete rejection of iron (99–100%) by NF when acetic acid-based chelating agent (pentasodium diethylenetriaminepentaacetate (DTPA)) was used to form complexes with the metals present in solution (iron and manganese). Kabsch-Korbutowicz and Winnicki [26] used sulfonated polysulfone / polysulfone membrane UF to remove iron. In the absence of humic acid, the iron removal was found between 15.0 and 32.1%, depending of the initial iron concentration and the membrane used. The addition of humic acid increased highly the iron removal which was found between 90 and

100% at pH 7 and iron concentration between 1 and $20 \text{ mg}\cdot\text{L}^{-1}$. The high iron removal was explained by the formation of iron-organic complexes which were retained by the membrane.

The main method to increase iron size before membrane filtration is the oxidation of iron to form ferric hydroxide particles. Several studies have reported hybrid membrane processes with MF or UF associated to oxidation obtained by biological treatment [14], sodium hypochlorite addition (prechlorination) [15,16], potassium permanganate addition [2] or air bubbling [6,27,28]. Prechlorination has been used in line with MF or UF for iron removal, in a crossflow mode or dead-end mode. For example, Choo et al. [15] removed iron and manganese from lake water using UF in-line with prechlorination. Two configurations were tested: crossflow UF with cellulose acetate fibers and stirred cell dead-end UF with regenerated cellulose membranes. Using the crossflow device, the iron removal was between 75 and 90%, even in the absence of prechlorination, while with the dead-end device, higher data were found, between 90 and 100%. In both configurations, fouling was expected to occur. Prechlorination was also used by Lin et al. [16] before dead-end polypropylene membranes MF. Iron oxidation was obtained by addition of sodium hypochlorite in a tank reactor. The suspension was then filtered using the dead-end set-up. The permeate flux was found to decrease strongly with time indicating high fouling by the ferric hydroxide particles. A specific attention was paid to the mixing intensity in the feed reactor which decreased slightly the particles size and thus fouling. Besides, Chen et al. [28] investigated the removal of iron and manganese from groundwater by aeration, chlorine oxidation and MF at a water treatment plant in Taiwan. The raw waters were oxidized by chlorine and then filtered by hollow fiber polytetrafluoroethylene (PTFE) MF in a submerged filtration mode. The MF step was compared to the traditional greensand filtration. Both processes gave high iron removal (around 98–99%), however the MF process permitted stable operation with lower water consumption, less manpower need, and land equipment.

In other studies, the water was oxygenated by air bubbling before being filtered by UF or MF. Ellis et al. [6] removed iron and manganese from synthetic and natural waters by a process which combined oxidation by air bubbling and MF. Polyethersulfone MF membranes were used in a crossflow configuration, and the permeate and the retentate were circulated back to the feed tank in order to maintain the feed concentration constant. For both synthetic and natural waters, the iron removal was very high with iron concentration in the permeate below $0.1 \text{ mg}\cdot\text{L}^{-1}$. The transmembrane pressure (TMP) was found to have a major role on flux decline, and thus membrane fouling, which was higher at higher pressure.

Different process configurations can be identified whatever the mode of oxygenation, by chemical addition or air bubbling. In the first configuration, the treatment is discontinuous, the oxidation takes place separately, in a reactor for instance, and the ferric hydroxide suspension is then filtered by MF or UF [2], while in the second configuration, the treatment is continuous, the water to be filtered being continuously added to the reactor and treated by UF or MF

coupled to the reactor [15,28]. In a third configuration, the reactor is coupled to UF or MF, the permeate and retentate being recycled in the reactor without continuous water addition [6,16,24]. For implementation at water treatment plant, the most interesting configuration is the second one, where the water to be treated is continuously added to an aerated reactor. Although, this configuration has been little studied in the literature and only at pilot plant [15,28].

This work intends to study an hybrid oxidation/MF process at lab scale using for the first time to our knowledge a ceramic membrane applied to the treatment of Tunisian groundwaters. In order to reach this purpose, a hybrid process has been developed combining oxidation in an aerated reactor coupled to MF in crossflow mode, the synthetic or natural water containing iron being continuously added to the reactor while the permeate was recovered. A tubular ceramic MF membrane due to its large inner diameter can prevent tube blocking. The effect of the operating parameters (pH, initial iron concentration, TMP) on the process performances (iron removal and permeate flux) has been studied. To investigate further the oxidation/MF process, filtration in dead-end mode was realized using polymeric membranes. The iron removal was measured and the membranes were observed by scanning electron microscopy (SEM).

2. Materials and methods

2.1. Synthetic water and natural groundwater

The hybrid process for iron removal was firstly studied on synthetic water obtained by dissolution of iron (II) chloride ($\text{FeCl}_2 \cdot 4\text{H}_2\text{O}$, purity $\geq 99.0\%$, Sigma Aldrich, France) in deionized water. The pH of the solution was then adjusted using an aqueous solution of sodium hydroxide (NaOH , $0.1 \text{ mol} \cdot \text{L}^{-1}$).

However, the presence of organic matter or other ions contained in natural waters may influence the iron oxidation and thus its removal from water. Thus, a natural groundwater from Gremda location (Tunisia) has been used in the last part of this work. The characteristics of the groundwater are summarized in Table 1. This groundwater has a low iron concentration ($\approx 0.83 \text{ mg} \cdot \text{L}^{-1}$), so iron (II) was added to reach a concentration of $10 \text{ mg} \cdot \text{L}^{-1}$.

Table 1
Groundwater composition

Parameters	Natural groundwater
pH (–)	7.3
TOC ($\text{mg} \cdot \text{L}^{-1}$)	5.3
Total Hardness ($^\circ\text{F}$)	84
Calcium Hardness ($^\circ\text{F}$)	48
Turbidity (NTU)	3.73
Conductivity ($\text{mS} \cdot \text{cm}^{-1}$)	3.26
[Fe] ($\text{mg} \cdot \text{L}^{-1}$)	0.83
Salinity ($\text{mg} \cdot \text{L}^{-1}$)	1.57
[Cl ⁻] ($\text{g} \cdot \text{L}^{-1}$)	1.42

2.2. Experimental set-up

The oxidation of ferrous iron was studied in two processes: (1) aeration in a batch reactor where samples were withdrawn to be filtered on small membranes in a dead-end configuration and (2) a hybrid process combining aeration in the reactor to the MF with recirculation of the retentate and continuous addition of water containing iron.

2.2.1. Aeration in batch reactor

The experimental set-up used for batch experiments is presented in Fig. 1a. The feed solution (synthetic or natural water) was oxidized in a 3 L double jacketed glass vessel. The reactor was also equipped with a pH probe in order to control and maintain the pH to the desired value by adding continuously NaOH ($0.1 \text{ mol} \cdot \text{L}^{-1}$). A pitched blade down-flow turbine (PTD-45-, 4 blades instainless steel), associated with an overhead stirrer (RW 20, IKA-WERK, Germany), was used to ensure the homogeneity of the mixing and a high gas/liquid interfacial area. Compressed air was bubbled thanks to a circular pipe regularly drilled placed at the bottom of the reactor. As oxygen mass transfer is not the limiting step of iron(II) oxidation in the range of pH studied [17], the same stirring speed (400 rpm, i.e. XXW/L) and the same pressure of the compressed air (10 psi) were used for all the experiments. Experiments were carried out at ambient temperature ($20\text{--}22^\circ\text{C}$).

2.2.2. Hybrid aeration/MF process

In the hybrid process, described in Fig. 1b, the oxidation was performed in the reactor as described above and the same operating conditions were applied. However, 10 min after the beginning of the experiment, the suspension was continuously pumped from the bottom of the reactor to the MF module. The MF membrane was a tubular Kerasep[®] ceramic membrane with a $7.63 \cdot 10^{-3} \text{ m}^2$ active area, supplied by Novasep. The membrane characteristics are reported in Table 2. Two pressure gauges were used, one at the inlet and the second at the outlet of the module, to set and control the TMP during the experiment. Additional feed solution was added continuously using a membrane pump (Quattroflow 150 S, Pall, France) in order to maintain the volume constant in the reactor. The retentate was recirculated at a cross-flow velocity of $3.2 \text{ m} \cdot \text{s}^{-1}$ using another membrane pump (Quattroflow 1000 S, Pall, France). The permeate flow was obtained by measuring the volume of liquid in a graduated cylinder with time.

The MF membrane was then regenerated. The washing was performed by flushing the membrane according to the following sequence: (1) rinsing with 3 L of deionized water, (2) 3 L glacial acetic acid (0.2 w/w %) at 40°C for 30 min (TMP = 1 bar), (3) 3 L of deionized water until neutrality, (4) 3 L sodium hydroxide (0.4 w/w %) at 40°C for 30 min (TMP = 1 bar) and (5) 3 L of deionized water until neutrality. Each experiment started with membrane rinsing and pure water permeability measurements to check the effectiveness of membrane regeneration.

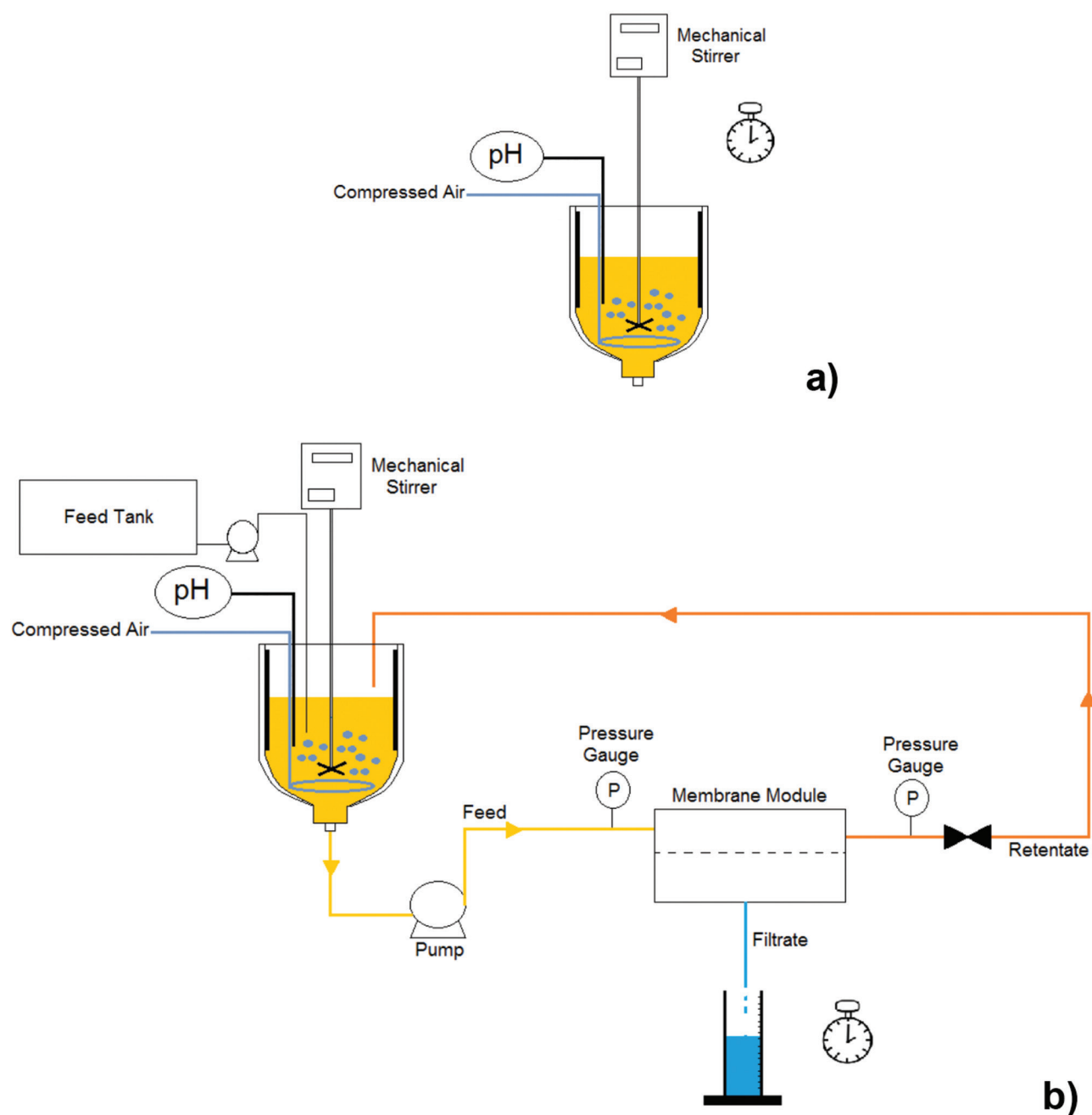

Fig. 1. Schematic diagrams of the experimental setups: a) aeration in batch reactor; b) hybrid aeration/MF process.

2.2.3. Dead-end filtration experiments

In addition to the hybrid process, some dead-end filtration experiments were realized with single-used membranes that were observed by scanning electron microscopy (SEM). These filtration experiments were done with a Swinnex filter holder, 47 mm supplied by Merck Millipore. The membrane diameter was 47 mm, and the active filtration area 13.8 cm². Two types of membranes were investigated both with 0.2 μm pore size: Nucleopore track-etched polycarbonate membranes from Whatman and cellulose acetate membranes from Sartorius Stedim. Samples of 10 mL were

taken in the aerated reactor every 10 min and filtered using the Swinnex holder. A new membrane was used for each filtration. In these experiments, the reactor was operated batchwise and the operating conditions were the following: initial iron concentration 10 mg·L⁻¹, pH 7, stirring speed 400 rpm and temperature 20–22°C.

The membranes were withdrawn from the filtration device and small pieces were cut for observation by SEM with a FEI Quanta 250 FEG microscope at the "Centre Technologique des Microstructures" (CTμ) from the University of Lyon 1 (Villeurbanne, France). The small piece of mem-

Table 2
Membrane characteristics

Membrane support	Monolithic TiO ₂ /Al ₂ O ₃
Layer	ZrO ₂ /TiO ₂
Inner membrane diameter (m)	6.0 × 10 ⁻³
Outer membrane diameter (m)	1.0 × 10 ⁻²
Tube length (m)	0.4
Membrane area (m ²)	7.63 × 10 ⁻³
Pore diameter (μm)	0.2

brane was deposited on a flat steel holder and coated under vacuum by cathodic sputtering with 10 nm of copper. The samples were then observed under an accelerating voltage of 15 kV. In addition, to the visualization of membranes by SEM, the ferric hydroxide particle size was measured on a Malvern 3000 instrument (Malvern).

2.3. Process performances

This study intends to investigate the influence of pH, initial iron concentration, and TMP on the iron removal and the filtration flux using the hybrid process. The ranges of the operating conditions regarding each parameter are summarized in Table 3. The tangential velocity was kept constant in all experiments (equal to 3.2 m·s⁻¹), as this parameter has been reported to have an insignificant effect on the permeation flux during the iron removal by oxidation/MF [6]. In addition, the hybrid process was used for iron removal from a natural groundwater, in order to determine the effect of the presence of organic matter and other ions.

In order to assess the process performances, the iron concentration in permeate samples was measured according to the 1,10-phenanthroline method (French Standard AFNOR NF T 90-017): 10 mL samples were taken at regular time intervals and acidified with 100 μL of H₂SO₄ (4.5 mol·L⁻¹) to stop the oxidation and store the samples until their analysis at the end of the experiment. Then, 200 μL from an ammonium acetate buffer solution and 100 μL from a hydroxylamine hydrochloride aqueous solution (100 g·L⁻¹) were added to 5 mL of each sample, respectively to maintain the pH of the samples between 3.5 and 5.5, and to reduce the

Table 3
Operating conditions

Temperature (°C)	Ambient (≈20–22°C)
Compressed air pressure (psi/bar)	10/0.69
Stirring rate (rpm)	400
Tangential velocity (m·s ⁻¹)	3.2
Initial concentration of Fe ²⁺ (mg·L ⁻¹)	5 – 10 – 15
pH (–)	6.8 – 7 – 7.2
TMP (bar)	0.6 – 3

dissolved ferric iron in ferrous iron. Finally, 200 μL from the 1,10-phenanthroline solution (5 g·L⁻¹) was added to the samples which were then stored in dark during 15 min. In conclusion, the iron concentration was measured using a UV-spectrophotometer (Cary 50 UV-Vis, Varian, France) at 510 nm wavelength.

The iron removal (%) was estimated using the following equation:

$$\text{Iron removal (\%)} = \frac{[\text{Fe}^{2+}]_0 - [\text{Fe}^{2+}]_p}{[\text{Fe}^{2+}]_0} \times 100 \quad (1)$$

with [Fe²⁺]₀ the initial iron concentration (mg·L⁻¹) and the iron concentration in the permeate (mg·L⁻¹).

In addition, to the 1,10-phenanthroline method which measures ferrous ion concentration, inductively coupled plasma optical emission spectrometry (ICP-OES) was used to measure the total iron concentration in permeate samples. The ICP-OES measurements were realized on an ACTIVA-M (HORIBA, France) instrument at the wavelength of 238.207 nm. Before the ICP-OES measurements, the samples were acidified with ultrapure nitric acid (Sigma Aldrich) at 5% v/v. The iron removal was estimated using a similar equation as Eq. (1) by changing [Fe²⁺] by [Fe]. The 1,10-phenanthroline method has a detection limit of 0.01 mg·L⁻¹ (i.e., 10 mg·L⁻¹) and the ICP-OES method 0.2 mg·L⁻¹.

3. Results and discussion

As mentioned previously, the oxidation rate of ferrous iron is affected by several factors such as Fe(II) and oxygen concentration, pH, temperature, organic matter and other ions in solution. It is also accelerated in the presence of ferric hydroxide (catalytic effect) at ferrous iron concentration above 5 mg·L⁻¹ [17,19]. Oxygen is used to oxidize ferrous iron into ferric iron according to Eq. (2), ferric iron is then precipitated into ferric hydroxide, Eq. (3), which is eliminated by filtration:

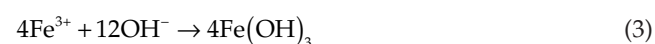
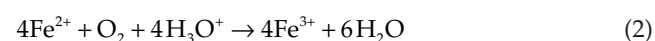

The kinetics of ferrous iron oxidation is given by Eq. (4) [17,20,22,23]:

$$r_{(\text{Fe}^{2+})} = K[\text{Fe}^{2+}][\text{OH}^-]^2[\text{O}_2] \quad (4)$$

where the kinetic constant K depends strongly on the ionic strength and on the dissolved counteranions [17].

3.1. Influence of the initial iron concentration

The influence of the initial iron concentration, ranging from 5 to 15 mg·L⁻¹, has been studied on the iron removal and the filtration flux using the hybrid process (Fig. 1b). The results, reported on Figs. 2 and 3, have been achieved with synthetic water, at pH 7, a temperature of 20–22°C and using a TMP of 0.6 bar.

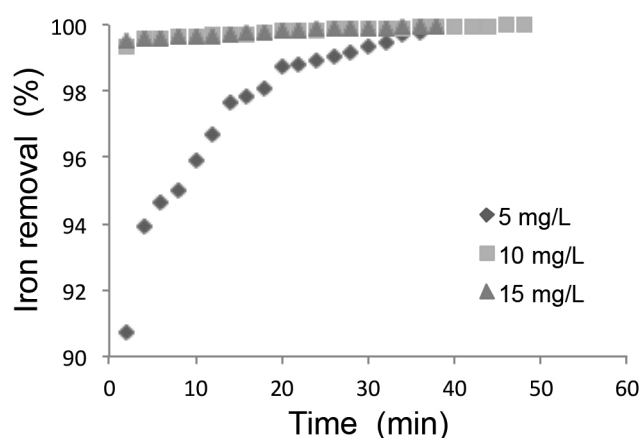

Fig. 2. Influence of the initial iron concentration on the variation of iron removal with time, hybrid process, pH = 7, TMP = 0.6 bar; $t = 0$ corresponds to the beginning of the filtration.

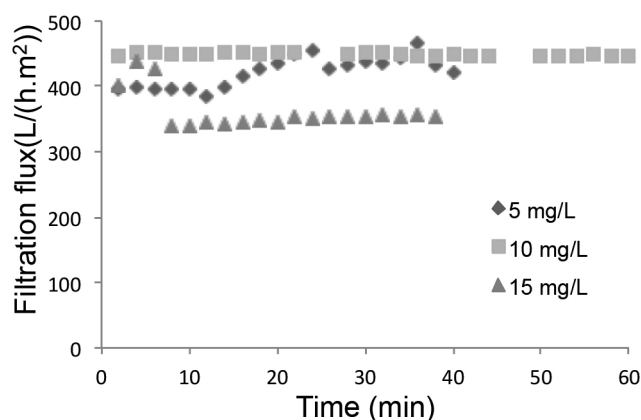

Fig. 3. Effect of the initial iron concentration on the variation of the filtration flux with time, hybrid process, pH = 7, TMP = 0.6 bar.

Whatever the initial concentration, the precipitation occurred within the initial period of aeration and before starting the suspension circulation in the filtration loop. Fig. 2 highlights that the iron removal was very high and close to 100% after 35 min of filtration at the lower initial concentration and quite immediately at higher initial concentrations. It is suggested that the mechanism of iron removal is mainly related to the steric rejection of the ferric hydroxide particles formed. The high iron removal may be attributed to the rapid kinetics of iron oxidation at pH = 7. Indeed, at higher iron concentration, a higher amount of iron hydroxide was formed which increased the kinetics of the oxidation reaction. The autocatalytic behaviour of ferric hydroxide has been reported by several authors [22,29]. For example, El Azher et al. [17] studied ferrous iron removal from drinking water using iron oxidation based on aeration in a split-rectangular airlift reactor. Their experimental data confirmed that an autocatalytic behaviour played a key role at high levels of ferrous iron, typically when the ferrous iron concentration was higher than 5 mg·L⁻¹. Besides, Tufekci and Sarikaya [19] demon-

strated that the catalytic effect of ferric hydroxide sludge on the oxidation of ferrous iron by aeration increased with increasing sludge age (for a period of 0 to 10 d). An additional effect may be the binding of Fe(OH)₃ particles to the membrane alumina support, which is also higher if the particle concentration is higher, i.e. when higher ferrous concentrations are used. The binding of ferric hydroxide has been reported previously, i.e. by Hlavay et Polyák [30] who prepared iron hydroxide-coated alumina adsorbent by *in situ* precipitation of iron hydroxide on the surface of activated Al₂O₃ as a support material.

High iron removal is in agreement with previous results from the literature obtained using membrane hybrid processes such as those of Choo et al. [15] and Zogo et al. [2]. Choo et al. [15] used crossflow UF in conjunction with in-line prechlorination [15] with 100 kDa UF cellulose acetate hollow fibers (Aquasource, France) with an effective area of 0.035 m². Iron removal was found between 66 and 92%, with and without prechlorination, being slightly dependent on the initial iron concentration. The high removal of iron without prechlorination was attributed to the oxidation of ferrous iron by dissolved oxygen and the subsequent formation of ferric hydroxide precipitates which were rejected by UF. Higher iron removal (between 97 and 100%) was obtained with dead-end UF with and without prechlorination. In that case, the filtration experiments were performed using a stirred cell with an effective filtration area of 28.7 cm². Zogo et al. [2] also reported complete removal of iron from surface water using pre-oxidation with potassium permanganate followed by filtration using a 0.22 μm pore size filter paper (Whatman).

The influence of the initial iron concentration on the filtration flux is reported in Fig. 3. The results obtained shows that the filtration flux stayed almost constant whatever the initial iron concentration. However, the flux was slightly lower at the iron concentration of 15 mg·L⁻¹. The absence of permeate flux decline indicates low membrane fouling by the ferric iron particles. The low pressure applied (below 1 bar) may correspond to conditions below the critical flux for which constant flux is obtained in cross-flow MF [31]. The large ferric hydroxide particles may be adequate to be swept away from the membrane surface by the crossflow, resulting in low fouling. In a previous study, Lin et al. [16] performed dead-end experiments with polypropylene MF membranes to remove ferric hydroxide particles obtained by iron chlorination using NaOCl. The dead-end experiments showed a high decrease in permeate flux; this high fouling was attributed mainly to the formation of a cake layer by the ferric hydroxide particles. In our experiments, crossflow has probably a crucial role in limiting membrane fouling.

Low membrane fouling by ferric hydroxide has been reported previously. In a study related to natural organic removal from a drinking water source by an integrated iron oxide adsorption/ UF process, Lee et al. [32] showed that the addition of iron oxide particles to stirred-cell UF improved both natural organic matter (NOM) removal and membrane flux even at high iron oxide particles up to 500 mg·L⁻¹. This was attributed to the fact that a large amount of iron oxide particles contributed to the adsorption removal of NOM and subsequent fouling reduction.

3.2. Influence of pH

The second operating parameter influencing the oxidation rate of ferrous iron into ferric iron is the pH. To investigate its effect on iron removal using the hybrid process, the pH of the feed was maintained between 6.8 and 7.2. Results, presented on Fig. 4, are obtained using the hybrid membrane process and an initial iron concentration of $10 \text{ mg}\cdot\text{L}^{-1}$. Fig. 4 clearly shows that the pH had no significant influence on the iron removal which stayed close to 100% during the experiments. Besides, it has been established by several authors that at higher pH, the kinetics of ferrous iron oxidation increases [17,20,22,23], as expected from Eq. (4). Therefore, the results obtained with the hybrid process suggest that despite the increase in ferric hydroxide concentration at higher pH, the efficiency of the hybrid membrane process stayed very high and all ferric hydroxide particles were retained by the membrane.

In addition, the filtration flux stayed almost constant with time (Fig. 5) at the different pH values. The absence of flux decline versus time suggest that membrane fouling was low, despite the higher amount of ferric hydroxide particles present in the feed. In addition, Fig. 5 shows that the increase of the pH value, from 6.8 to 7.2, induced a slight

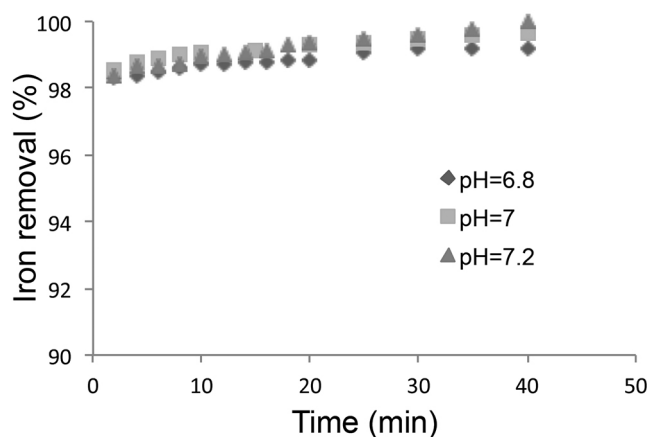

Fig. 4. Influence of the pH on the variation of iron removal with time, hybrid process, $[\text{Fe}^{2+}]_0 = 10 \text{ mg}\cdot\text{L}^{-1}$, TMP = 0.6 bar.

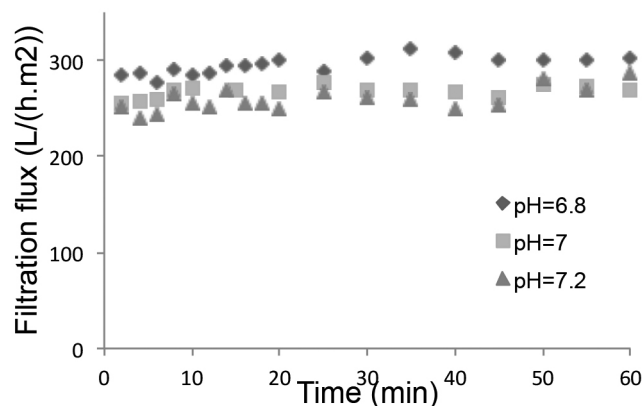

Fig. 5. Influence of the pH on the variation of the filtration flux with time, hybrid process, $[\text{Fe}^{2+}]_0 = 10 \text{ mg}\cdot\text{L}^{-1}$, TMP = 0.6 bar.

decrease of the permeate flux from 300 to $250 \text{ L}\cdot\text{h}^{-1}\cdot\text{m}^{-2}$. This may suggest that a higher concentration of ferric hydroxide particles in the filtration loop, at pH 7.2, decreased slightly the filtration flux.

3.3. Influence of the transmembrane pressure

The influence of the TMP on the process performances was evaluated in terms of iron removal and filtration flux. The results obtained are reported on Figs. 6 and 7. Three TMP have been compared: 0.6, 1 and 3 bar. These pressures were obtained by closing more or less the valve added in the loop after the membrane module. The experiments were carried out on the hybrid process, the retentate being recirculated in the reactor and the permeate recovered.

Fig. 6 highlights that the iron removal was independent of pressure and was closed to 100% from the first minutes of treatment for TMP between 0.6 and 3 bar. In addition, Fig. 7 shows that the permeate flux remained constant with

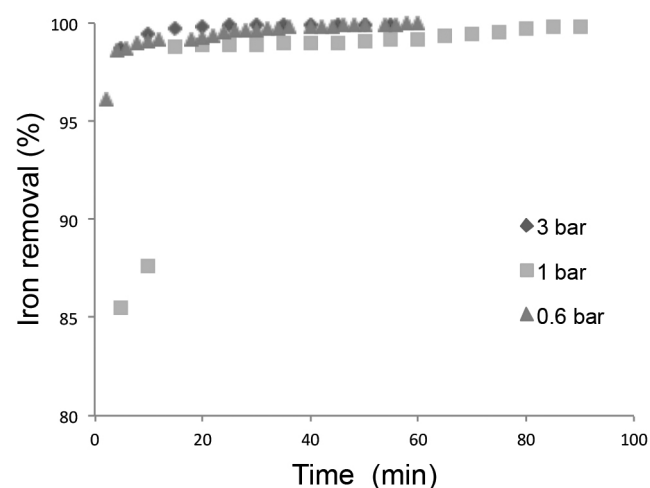

Fig. 6. Influence of TMP on the variation of iron removal with time, hybrid process, $[\text{Fe}^{2+}]_0 = 10 \text{ mg}\cdot\text{L}^{-1}$, pH=7.

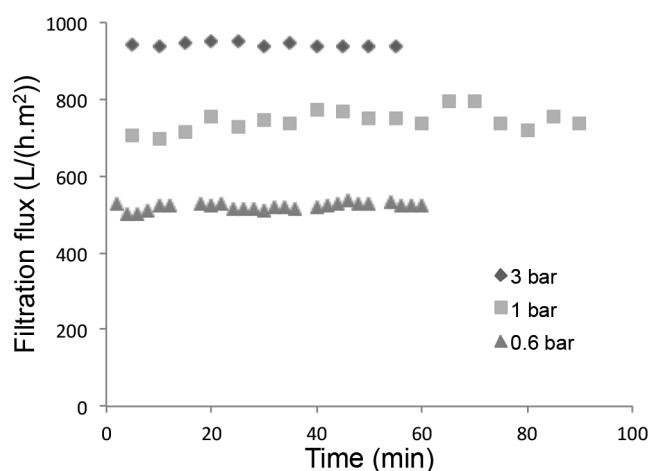

Fig. 7. Influence of TMP on the variation of filtration flux with time, hybrid process, $[\text{Fe}^{2+}]_0 = 10 \text{ mg}\cdot\text{L}^{-1}$, pH = 7.

time which confirms that membrane fouling either at the membrane surface or inside the membrane pores was not significant. It can also be noted that the flux increased with TMP, being close to $750 \text{ L}\cdot\text{h}^{-1}\cdot\text{m}^{-2}$ at 1 bar. This corresponds to the treatment of 5 L in 50 min. Besides, Kerasep membranes (Novasep, France) are available at very high membrane surface, so it is expected that very high fluxes could be obtained for the treatment of drinking water at industrial scale with these large membrane areas.

Moreover, at a TMP of 3 bar, the high iron removal associated to low fouling suggest that relative high pressure could be used, which could be favourable to the treatment of large volumes of drinking water at high flux. Although, as reported generally, the TMP should have to be kept below a critical value to avoid membrane fouling during MF [31]. Using an oxidation/ MF process, Ellis et al. [6] showed that at higher TMP, the permeation flux decreased more rapidly than at lower pressure, a relatively high and constant

permeation flux being obtained at a pressure below 0.1 bar (10 kPa). Under this low pressure, the permeation flux was comparable to slow sand filtration flux at a similar pressure difference but with a much thinner filtering medium. These authors concluded to the advantages of the oxidation/MF system which could be more compact than a conventional slow sand filter.

3.4. Dead-end filtration experiments

To investigate further the removal of iron by aeration/MF, samples were taken in the aerated reactor (Fig. 1a) and filtered with polycarbonate or acetate cellulose membranes using the Swinnex filter holder. Both membranes were then observed by SEM, as shown in Fig. 8a and 8b, respectively for the polycarbonate and cellulose acetate membranes. The ferric hydroxide particles deposited on the membrane

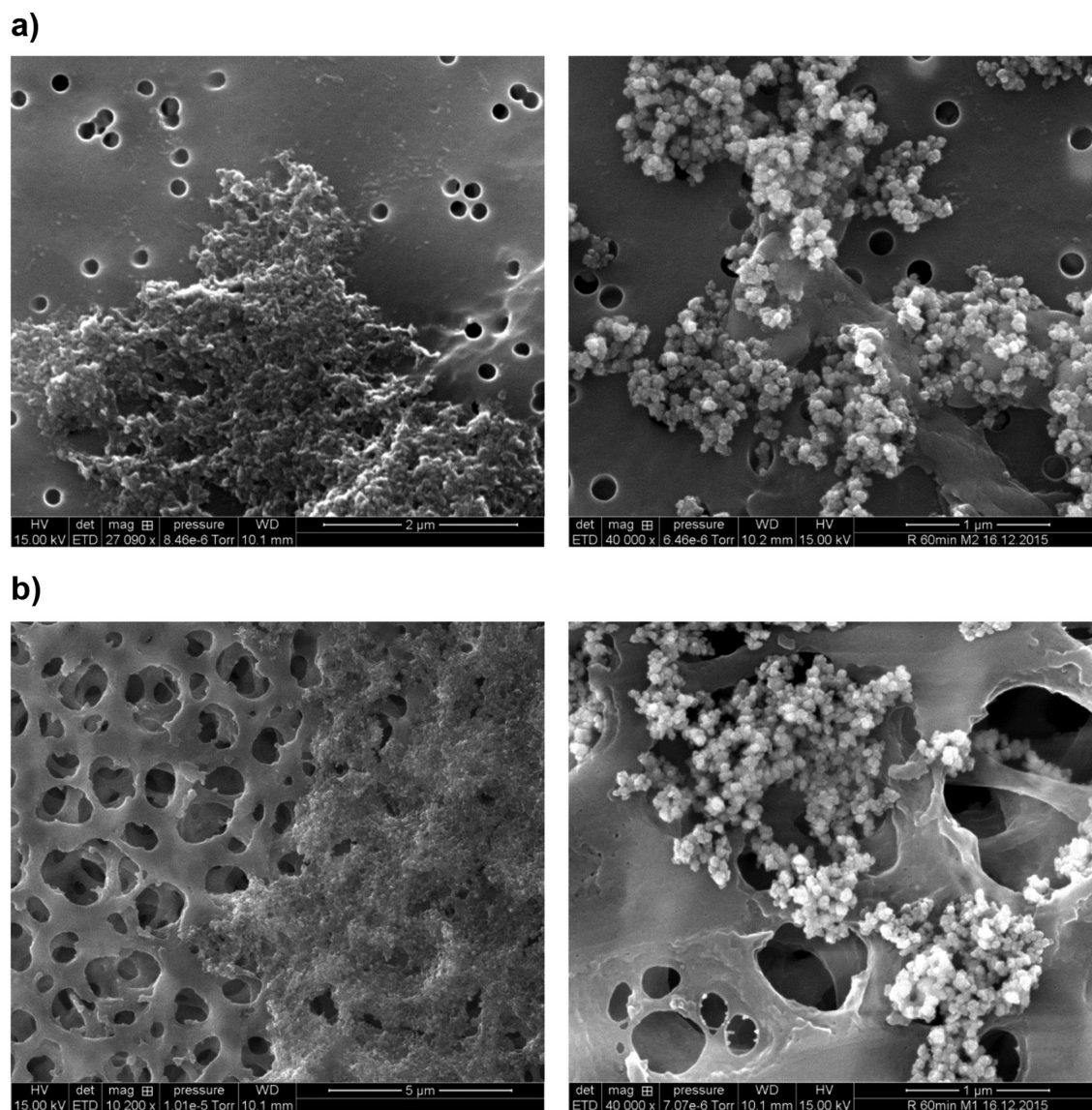

Fig. 8. SEM pictures of iron hydroxide particles retained by a) a 0.2 μm polycarbonate membrane, and b) a 0.2 μm cellulose acetate membrane. The samples were taken from the feed tank (Fig. 1a) after 1 h of aeration and filtered.

surface appeared as very small particles (around 50–100 nm in size) agglomerated in larger particles. These large agglomerates were found to have very different sizes.

Besides, samples were taken in the feed reactor after 1 h of aeration and the particle size distribution was measured with the Malvern 3000 instrument. A typical graph is shown in Fig. 9. The particle size was very dispersed, from some microns to 100 μm . In Fig. 9, the mean size (d_{50}) was found around 20 μm , while d_{10} and d_{90} were respectively 7 μm and 40 μm . The parameters d_{10} , d_{50} and d_{90} are respectively the particle size at 10, 50 and 90% of the volume density. The 0.2 μm pore size membranes should be then suitable for the removal of these large particles. This size of ferric hydroxide particles corresponds to previous results between 1.5 and 50 μm [6], smaller particles size has also been reported between 2 and 15 μm [28]. Some authors also pointed out that the particles stopped growing within a few minutes [6,16].

In the hybrid aeration/MF process which operates in crossflow, a constant filtration flux was obtained suggesting low fouling. This could be attributed to the large size of the aggregates observed on the SEM images and measured on the Malvern instrument. Indeed, it is usually admitted that in crossflow MF small particles attach to the layer at the membrane surface much easier than larger particles [33]. This is due to the balance between the lift force and the drag force of the filtrate flow which determines the particle transport to the layer.

Besides, the total iron concentration was measured in the permeate by ICP-OES (Table 4). The iron concentration in the permeate was found constant after 10 min of filtration, therefore the reported values in Table 4 are the average of 5 or 6 measurements between 10 min and the end of the experiment (1 h). With the Nucleopore and the cellulose acetate membranes, the iron concentrations in the filtrate were higher than the ones obtained with the hybrid oxidation/ceramic MF membrane, both for the synthetic and natural waters.

In addition, lower iron removal was observed with the Nucleopore membrane than with the acetate membrane. This suggests an effect of the membrane material on iron removal.

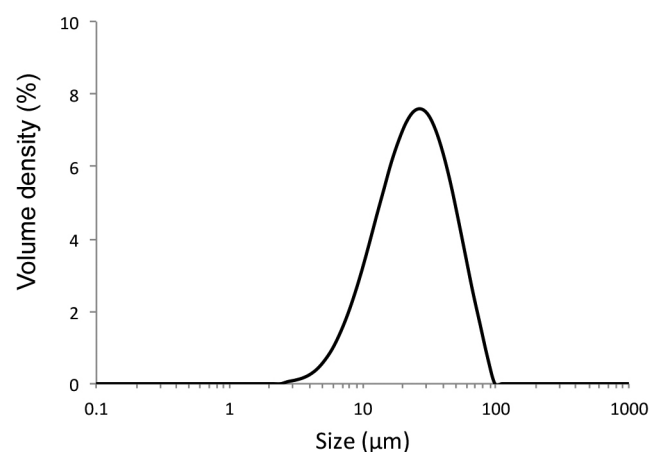

Fig. 9. Size distribution of the iron hydroxide particles measured on a Mastersizer 3000 (Malvern Instrument). The samples were taken from the feed tank (Fig. 1a) after 1 h of aeration.

Table 4
Iron removal by ceramic and polymeric membranes

Iron removal (%)	Keracem ceramic membrane	Cellulose acetate membrane	Nucleopore polycarbonate membrane
Synthetic water	99.3	96.2	10.9
Gremda groundwater	99.5	97.5	10.7

Experimental conditions for the polymeric membranes: initial iron concentration 10 $\text{mg}\cdot\text{L}^{-1}$, pH 7, feed volume 3 L. For the ceramic membrane, additional conditions are indicated in Table 3. The iron removal was obtained from ICP-OES measurements. The values are the average of 5–10 measurements at different time.

The cellulose acetate membrane being more hydrophilic than the polysulfone membrane [34], the hydrophilic iron hydroxide particles may tend to attach more strongly to its surface. The removal of the iron hydroxide particles on the membrane surface may then become more important with the cellulose acetate membrane than with the polysulfone membrane. A similar effect was reported by [27] when comparing the performance of mixed cellulose ester hydrophilic membrane and polyvinylidene (PVDF) hydrophobic membrane for iron removal by oxidation/MF. The hydrophilic membrane gave a lower filtration flux as well as slightly higher removal efficiency than the hydrophobic membrane, both phenomena being explained by the more important layer formed on the hydrophilic membrane surface.

3.5. Treatment of the groundwater from Gremda (Tunisia)

In addition to synthetic waters, a natural groundwater from Gremda (Tunisia) was treated with the aeration/MF process. First of all, the natural groundwater was characterized (Table 1). The natural groundwater contained a low total organic compound (TOC) around 5.3 $\text{mg}\cdot\text{L}^{-1}$. The amount of iron (0.83 $\text{mg}\cdot\text{L}^{-1}$) was slightly higher than the limit fixed by the WHO. For the experiment, ferric iron was added at a concentration of 10 $\text{mg}\cdot\text{L}^{-1}$, to simulate natural groundwaters containing a high amount of iron. The other ions contained in the Gremda groundwater included Cl^- , Ca^{2+} , and CaCO_3^{2-} .

The results are compared to those obtained with the synthetic water regarding the iron removal and the filtration flux, respectively in Figs. 10 and 11. The results show that the synthetic water and the natural groundwater had similar behaviour and that the iron removal was around 100% (Fig. 10). Besides, Fig. 11 shows that the filtration fluxes were similar for the synthetic and the natural waters and that in both cases the flux remained almost constant over time suggesting low membrane fouling. This highlights that the presence of organic matter, at least at this low concentration, had no significant influence on the process performances both for iron removal and filtration flux. However, fouling was tested on a limited time scale (around 1 h) and the possibility of occurrence of fouling on longer times will have to be investigated.

Moreover, these results highlight that there is no significant influence from the other ions contained in the Gremda

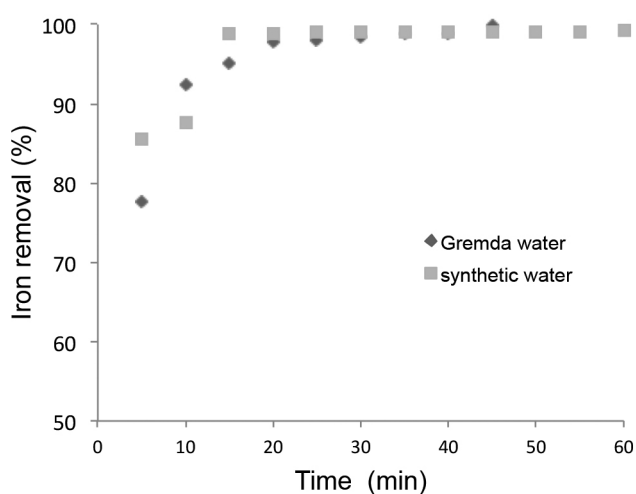

Fig. 10. Variation of iron removal with time for the groundwater from Gremda, hybrid process, $[\text{Fe}^{2+}]_0 = 10.8 \text{ mg}\cdot\text{L}^{-1}$, $\text{pH} = 7$, $\text{TMP} = 1 \text{ bar}$.

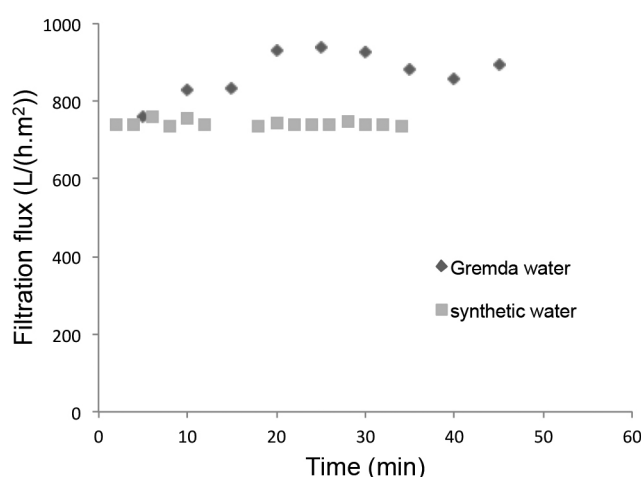

Fig. 11. Variation of filtration flux with time for the groundwater from Gremda, hybrid process, $[\text{Fe}^{2+}]_0 = 10.8 \text{ mg}\cdot\text{L}^{-1}$, $\text{pH} = 7$, $\text{TMP} = 1 \text{ bar}$.

groundwater on the process performance. Therefore, these results indicate that synthetic waters can be used to conduct lab scale experiments to simulate natural groundwaters. This was already demonstrated by Ellis et al. [6] using natural and synthetic waters in an oxidation/MF process designed for iron and manganese removal. However, the Gremda groundwater treated in this study contained a low amount of NOM and further experiments should be conducted in order to better understand the effect of organic matter on iron removal and permeate flux. It is usually reported that NOM has a major effect on natural groundwater treatment and that ferric hydroxide particles can be an effective adsorbent for the removal of NOM [27,32].

4. Conclusion

Groundwater is a major source of water supply in Tunisia. However, it often contains high amounts of minerals

like iron, mainly released by rocks. High iron concentrations are sources of several problems like bad taste, unpleasant colour as well accelerated corrosion of pipes. In this study, we evaluated the performance of a hybrid membrane process for continuous iron removal. An aerated reactor, fed continuously by a synthetic iron solution, was coupled to a MF ceramic membrane, in a closed loop configuration. The effect of several parameters (pH, iron concentration, TMP) was investigated showing little effect on the iron removal and the filtration flux.

Removal of iron was found very high (around 99%) and the iron concentration in the permeate collected was below the limit fixed by the WHO ($0.3 \text{ mg}\cdot\text{L}^{-1}$). Besides, the filtration flux was nearly constant during the water treatment suggesting low membrane fouling. Similar results were obtained with the groundwater from Gremda (Tunisia) containing organic matter as well as other ions. The high retention of iron and the low fouling obtained with by the hybrid process may be explained by the large agglomerates of ferric hydroxide that are easily retained but the $0.2 \mu\text{m}$ membrane and induce low fouling in crossflow MF at relatively low pressure. Therefore, the ceramic membrane used in this study appears as a suitable alternative to other membranes previously tested for iron removal by oxidation/MF.

In the hybrid aeration/MF process, the water is continuously treated which is an advantage for implementation at large scale. The crossflow configuration is also an advantage as it reduces membrane fouling compared to dead-end filtration and results in the treatment of large volumes in a long term use. Compared to the traditional technology of air bubbling and sand filtration, the oxidation/MF process permits lower water consumption, less manpower need and land requirement, and better water quality, its drawbacks are related to the higher costs in construction and operation [27]. Also, it has been demonstrated that the catalytic effect of ferric hydroxide sludge on the oxidation of ferrous iron by aeration increased with increasing sludge age (up to 10 d) which confirms the potential of continuous flow iron oxidation reactors with ferric sludge recycle [19]. Besides, iron oxide particles have been shown very effective in the removal of NOM from drinking water [32]. These phenomena are both favourable for the implementation of the aeration/MF process at large scale for the treatment of groundwater containing iron. Iron bacteria which could be present in groundwaters are also reported to accelerate the Fe^{2+} oxidation and thus improve iron removal; this effect is used in biological iron removal plant [12].

Acknowledgements

The authors acknowledge Campus France (grant Utique 13G1111, 2012–2015) for financial support. They also acknowledge the SONEDE (Tunisia) for providing the natural groundwater from Gremda. In addition, the authors would like to thank Gérardine Agusti (Laboratoire d'Automatique et de Génie des Procédés, Université Lyon 1, France) for obtaining the SEM images, the "Centre Technologique des Microstructures" (CTμ) of the University of Lyon (Villeurbanne, France) for providing the SEM infrastructure, and José Marie Arnoux (CPE, Villeurbanne, France) for developing the ICP-OES method.

References

- [1] WHO, Guidelines for drinking-water quality, 4th ed., 2011.
- [2] D. Zogo, L.M. Bawa, H.H. Soclo, D. Atchekpe, Influence of pre-oxidation with potassium permanganate on the efficiency of iron and manganese removal from surface water by coagulation-flocculation using aluminium sulphate: Case of the Okpara dam in the Republic of Benin, *J. Environ. Chem. Ecotoxicol.*, 3 (2011) 1–8.
- [3] S. Chaturvedi, P.N. Dave, Removal of iron for safe drinking water, *Desalination*, 303 (2012) 1–11.
- [4] S. Vasudevan, J. Jayaraj, J. Lakshmi, G. Sozhan, Removal of iron from drinking water by electrocoagulation: Adsorption and kinetics studies, *Korean J. Chem. Eng.*, 26 (2010) 1058–1064.
- [5] S.S. Tahir, N. Rauf, Removal of Fe(II) from the wastewater of a galvanized pipe manufacturing industry by adsorption onto bentonite clay, *J. Environ. Manage.*, 73 (2004) 285–292.
- [6] D. Ellis, C. Bouchard, G. Lantagne, Removal of iron and manganese from groundwater by oxidation and microfiltration, *Desalination*, 130 (2000) 255–264.
- [7] K. Vaaramaa, J. Lehto, Removal of metals and anions from drinking water by ion exchange, *Desalination*, 155 (2003) 157–170.
- [8] E. Okoniewska, J. Lach, M. Kacprzak, E. Neczaj, The removal of manganese, iron and ammonium nitrogen on impregnated activated carbon, *Desalination*, 206 (2007) 251–258.
- [9] B. Das, P. Hazarika, G. Saikia, H. Kalita, D.C. Goswami, H.B. Das, S.N. Dube, R.K. Dutta, Removal of iron from groundwater by ash: A systematic study of a traditional method, *J. Hazard. Mater.*, 141 (2007) 834–841.
- [10] B.-Y. Cho, Iron removal using an aerated granular filter, *Process Biochem.*, 40 (2005) 3314–3320.
- [11] P.D. Nemade, A.M. Kadam, H.S. Shankar, Removal of iron, arsenic and coliform bacteria from water by novel constructed soil filter system, *Ecol. Eng.*, 35 (2009) 1152–1157.
- [12] P. Mouchet, From conventional to biological removal of iron and manganese in France, *J. AWWA*, (1992) 158–167.
- [13] A.G. Tekerlekopoulou, I.A. Vasiliadou, D.V. Vayenas, Physico-chemical and biological iron removal from potable water, *Biochem. Eng. J.*, 31 (2006) 74–83.
- [14] I.A. Katsoyiannis, A. Zouboulis, M. Mitrakas, H.W. Althoff, A hybrid system incorporating a pipe reactor and microfiltration for biological iron, manganese and arsenic removal from anaerobic groundwater, *Fresenius Environ. Bull.*, 22 (2013) 3848–3853.
- [15] K.-H. Choo, H. Lee, S.-J. Choi, Iron and manganese removal and membrane fouling during UF in conjunction with prechlorination for drinking water treatment, *J. Membr. Sci.*, 267 (2005) 18–26.
- [16] J.-L. Lin, C. Huang, J.R. Pan, Y.-S. Wang, Fouling mitigation of a dead-end microfiltration by mixing-enhanced preoxidation for Fe and Mn removal from groundwater, *Colloids Surf. Physicochem. Eng. Asp.*, 419 (2013) 87–93.
- [17] N. El Azher, B. Gourich, C. Vial, M.B. Soulami, M. Ziyad, Study of ferrous iron oxidation in Morocco drinking water in an airlift reactor, *Chem. Eng. Process. Process Intensif.*, 47 (2008) 1877–1886.
- [18] R.P. Azar, C. Falamaki, Removal of aqueous Fe²⁺ using MnO₂-clinoptilolite in a batch slurry reactor: Catalyst synthesis, characterization and modeling of catalytic behavior, *J. Ind. Eng. Chem.*, 18 (2012) 737–743.
- [19] N. Tufekci, H.Z. Sarikaya, Influence of ageing on the catalytic activity of ferric sludge for oxidation of Fe(II), *Water Sci. Technol.*, 38 (1998) 129–137.
- [20] H. Tamura, K. Goto, M. Nagayama, The effect of ferric hydroxyde on the oxygenation of ferrous ions in neutral solutions, *Corros. Sci.*, 16 (1976) 197–207.
- [21] N. Tufekci, G. Demir, Catalytic effects of Fe(III) during oxygenation of Fe(II) in continuous flow iron removal systems, *Fresenius Environ. Bull.*, 11 (2002) 863–868.
- [22] W. Davison, G. Seed, The kinetics of the oxidation of ferrous iron in synthetic and natural waters, *Geochim. Cosmochim. Acta.*, 47 (1983) 67–79.
- [23] W. Sung, J.J. Morgan, Kinetics and product of ferrous iron oxygenation in aqueous systems, *Environ. Sci. Technol.*, 14 (1980) 561–568.
- [24] A. Lastra, D. Gómez, J. Romero, J.L. Francisco, S. Luque, J.R. Álvarez, Removal of metal complexes by nanofiltration in a TCF pulp mill: technical and economic feasibility, *J. Membr. Sci.*, 242 (2004) 97–105.
- [25] A. Korchef, I. Kerkeni, M.B. Amor, S. Galland, F. Persin, Iron removal from aqueous solution by oxidation, precipitation and ultrafiltration, *Desal. Water Treat.*, 9 (2009) 1–8.
- [26] M. Kabsch-Korbutowicz, T. Winnicki, Application of modified polysulfone membranes to the treatment of water solutions containing humic substances and metal ions, *Desalination*, 105 (1996) 41–49.
- [27] L. Setyadhi, J.C. Liu, Oxidation–microfiltration removal of Fe(II) from water, *Desal. Water Treat.*, 51 (2013) 374–383.
- [28] W.-H. Chen, Y.-H. Hsieh, C.-C. Wu, M.-W. Wan, C.M. Futalan, C.-C. Kan, The on-site feasibility study of iron and manganese removal from groundwater by hollow-fiber microfiltration, *J. Water Supply Res. Technol. Aqua.*, 60 (2011) 391–401.
- [29] M. Roustan, Transferts gaz-liquide dans les procédés de traitement des eaux et des effluents gazeux, *Tec&Doc Lavoisier*, 2003. <http://www.lavoisier.fr/livre/environnement/transferts-gaz-liquide-dans-les-procedes-de-traitement-des-eaux-et-des-effluents-gazeux/roustan/descriptif-9782743006051> (accessed January 5, 2016).
- [30] J. Hlavay, K. Polyák, Determination of surface properties of iron hydroxide-coated alumina adsorbent prepared for removal of arsenic from drinking water, *J. Colloid Interface Sci.*, 284 (2005) 71–77.
- [31] R.W. Field, D. Wu, J.A. Howell, B.B. Gupta, Critical flux concept for microfiltration fouling, *J. Membr. Sci.*, 100 (1995) 259–272.
- [32] K.-W. Lee, K.-H. Choo, S.-J. Choi, K. Yamamoto, Development of an integrated iron oxide adsorption/membrane separation system for water treatment, (2002). <http://www.iwaponline.com/ws/00205/ws002050293.htm> (accessed April 8, 2015).
- [33] J. Altmann, S. Ripperger, Particle deposition and layer formation at the crossflow microfiltration, *J. Membr. Sci.*, 124 (1997) 119–128.
- [34] D.R. Paul, Y.P. Yampol'skii, *Polymeric Gas Separation Membranes*, CRC Press, 1993.