



**HAL**  
open science

## State filtering for networked control systems subject to switching disturbances

Karim Chabir, Taouba Rhouma, Jean-Yves Keller, Dominique Sauter

► **To cite this version:**

Karim Chabir, Taouba Rhouma, Jean-Yves Keller, Dominique Sauter. State filtering for networked control systems subject to switching disturbances. *International Journal of Applied Mathematics and Computer Science*, 2018, 28 (3), pp.473-482. 10.2478/amcs-2018-0036 . hal-01898069

**HAL Id: hal-01898069**

**<https://hal.science/hal-01898069>**

Submitted on 27 May 2021

**HAL** is a multi-disciplinary open access archive for the deposit and dissemination of scientific research documents, whether they are published or not. The documents may come from teaching and research institutions in France or abroad, or from public or private research centers.

L'archive ouverte pluridisciplinaire **HAL**, est destinée au dépôt et à la diffusion de documents scientifiques de niveau recherche, publiés ou non, émanant des établissements d'enseignement et de recherche français ou étrangers, des laboratoires publics ou privés.



Distributed under a Creative Commons Attribution - NonCommercial - NoDerivatives 4.0 International License

## STATE FILTERING FOR NETWORKED CONTROL SYSTEMS SUBJECT TO SWITCHING DISTURBANCES

KARIM CHABIR <sup>a,\*</sup>, TAOUBA RHOUMA <sup>a</sup>, JEAN YVES KELLER <sup>b</sup>, DOMINIQUE SAUTER <sup>b</sup>

<sup>a</sup>MACS Laboratory: Modeling, Analysis and Control of Systems  
National Engineering School of Gabes (ENIG), University of Gabes, 6029 Gabes, Tunisia  
e-mail: karim.chabir@yahoo.fr, taouba.rhouma@gmail.com

<sup>b</sup>Research Center for Automatic Control of Nancy  
Lorraine University, CRAN UMR 7039, BP 70239, Vandœuvre les Nancy, France  
e-mail: {jean-yves.keller, dominique.sauter}@univ-lorraine.fr

State estimation of stochastic discrete-time linear systems subject to unknown inputs has been widely studied, but few works take into account disturbances switching between unknown inputs and constant biases. We show that such disturbances affect a networked control system subject to deception attacks on the control signals transmitted by the controller to the plant via unreliable networks. This paper proposes to estimate the switching disturbance from an augmented state version of the intermittent unknown input Kalman filter. The sufficient stochastic stability conditions of the obtained filter are established when the arrival binary sequence of data losses follows a Bernoulli random process.

**Keywords:** Kalman filter, unknown inputs, constant bias, switching disturbances, linear system, covariance matrix.

### 1. Introduction

Over the last three decades, Kalman filtering has attracted more and more attention in various areas. It plays a prominent role in systems theory and has been produced on a wide variety of application domains (Kailath *et al.*, 2000; Simon, 2006). Recently, there has been a growing research interest in the problem of optimal state filtering in the presence of persistent unknown inputs, representing unknown disturbances or unmodeled dynamics.

One of the most popular approaches used to solve this problem consists in representing the unknown inputs as a deterministic or stochastic bias, augmenting the original state equation with bias states, and then applying the Kalman filter to the augmented state model of the system. For the design of the augmented state Kalman filter (ASKF) (see Alouani *et al.*, 1992; Friedland, 1969; Hsieh and Chen, 1999; Kim *et al.*, 2006; Chabir *et al.*, 2014). When there is no prior information available about the unknown input, an optimal recursive state filter to decouple the state estimation error from unknown inputs is presented by Kitanidis (1987). Darouach *et al.* (1992)

set forth another approach that consists in transforming a standard system with unknown inputs into a singular system without unknown inputs.

Other optimal filters closer to the standard Kalman filter have been derived by minimizing the estimation error covariance matrix with respect to a reduced state feedback gain. This represents the degrees of freedom in the design of the unknown input Kalman filter (UIKF) (Chen and Patton, 1996; Darouach and Zasadzinski, 1997; Hou and Patton, 1998; Chabir *et al.*, 2008). The closely related problem of joint input and state estimation for linear discrete-time systems, which are of great importance for fault tolerant control (FTC) when each component of the unknown inputs vector represents actuator or component faults (Blanke *et al.*, 2006), has been recently studied by Fang *et al.* (2011), Gillijns and De Moor (2007) and Ben Hmida *et al.* (2010). The unknown input decoupling constraint can be viewed as a limit case of a more general assignment used in the design of stochastic detection filters for fault detection and isolation (FDI) problems as explained by Patton and Chen (1999), Keller and Sauter (2011), Kim and Park (2003) or Park *et al.* (1994).

\*Corresponding author

With the rapid progress of technology and new control strategies, networked control systems (NCSs) have been at the core of several infrastructure systems and industrial plants. They present challenging problems arising from the fact that sensors, actuators and controllers exchange information via a digital communication network. The state of the art for the design of control systems under packet loss or packet delay has been surveyed by Hespanha *et al.* (2007). In the past few years, the problems of the Kalman filtering in the presence of random observations losses represented by Markovian or Bernoulli processes, have stirred up a great deal of research interests. Considerable research efforts have been reported by Liu and Goldsmith (2004), Schenato *et al.* (2007) or Sinopoli *et al.* (2004). The case where the availability of observations is regulated by a semi-Markov chain has been discussed lately by Censi (2011). A novel scheme to detect intermittent faults (IFs) in linear stochastic systems with ideal measurements and study the detectability of IFs was analysed by Sandberg *et al.* (2016) and Zhou *et al.* (2014). Recently, the intermittent unknown input Kalman filter (IIKF) has been studied by Keller and Sauter (2013), assuming that the packet arrivals of the unknown inputs are modeled as a known binary sequence.

The parameterized approach discussed by Darouach and Zasadzinski (1997) makes it necessary to precompute off-line the structure of the state feedback gain for each combinatorial situation of the binary sequence. In turn, the intermittent unknown input decoupling constraint parameterized by Keller and Sauter (2013) calculates it from two constant size matrices, called the free and the constrained parts of the gain. From a two-stage optimization strategy that is very similar to those described by Friedland (1969) and Chabir *et al.* (2010), the free gain and the constrained gain are both used to minimize the trace of the state-estimation-error covariance matrix and the trace of the unknown-input-estimation error covariance matrix.

Besides failures of components or packet loss and packet delay, cyber physical systems (CPSs) became vulnerable to cyber physical attacks (CPAs) incorporating cyber and physical activities into a malicious attack. A sharp rise in the number of cyber attacks has been reported over the last few years. A great concern for the analysis of vulnerabilities of NCSs to external CPAs has been consequently noticed, as explained by Sandberg *et al.* (2015). Attacks on NCSs are summarized as follows: denial of service (DoS) attacks are designed by Amin *et al.* (2009) when the adversary prevents the controller from receiving sensor measurements or the plant from receiving the control law. Deception attacks are presented by Liu *et al.* (2009) and Teixeira *et al.* (2010) when the adversary sends false information about sensors or actuators. Replay attacks are developed by

Mo and Sinopoli (2009) or Bixiang *et al.* (2015) when the adversary generates artificial measurement delays. Covert attacks are designed by Smith (2011) when the adversary takes the control of the plant. Finally, there are direct physical attacks on sensors and/or actuators close to traditional faults that are taken into account by FDI techniques. When an attacker adds false data to the control signal, the induced unknown input becomes a constant bias when the control signal is blocked to its previous value at the occurrence times of data losses. For state filtering with disturbances switching between unknown input and constant bias, Keller *et al.* (2016) have recently applied the IIKF on the time-invariant augmented state model of the plant by forcing the unknown input to be the complementary state of the bias. This paper extends this state filtering strategy to the case where the control signals are transmitted by the controller to the plant via a multichannel unreliable network.

The paper is organized as follows. Section 2 presents the state filtering under switching disturbances. Section 3 solves the state filtering problem and studies the filters stability. An illustrative example is given in Section 4 before conclusions in Section 5.

## 2. Problem statement

Consider the following stochastic linear discrete-time system

$$x_{k+1} = Ax_k + Bu_k + w_k, \tag{1}$$

$$y_k = Cx_k + v_k \tag{2}$$

with  $B = [B^1 \dots B^i \dots B^q]$ , where  $i \in \{1, \dots, N\}$  is the set of subsystems,  $u_k \in \mathbb{R}^q$  and  $\text{rank}(CB) = \text{rank}(B) = q \leq m$ . Here  $x_k \in \mathbb{R}^n$ ,  $u_k = [u_k^1 \dots u_k^i \dots u_k^q]^T \in \mathbb{R}^q$ ,  $y_k \in \mathbb{R}^m$  are the state, control and measurement vectors, respectively, and  $w_k \in \mathbb{R}^n$  and  $v_k \in \mathbb{R}^m$  are the zero mean white Gaussian state and measurement noise signals satisfying

$$E \left\{ \begin{bmatrix} w_k \\ v_k \end{bmatrix} \begin{bmatrix} w_j \\ v_j \end{bmatrix}^T \right\} = \begin{bmatrix} W & 0 \\ 0 & I \end{bmatrix} \delta_{k,j} \tag{3}$$

with  $W \succeq 0$ .

The initial state  $x_0$ , assumed to be uncorrelated with  $w_k$  and  $v_k$ , is a Gaussian random variable with  $E\{x_0\} = \bar{x}_0$  and  $P_0 = E\{(x_0 - \bar{x}_0)(x_0 - \bar{x}_0)^T\} \geq 0$ .

The plant is controlled by the NCS subject to deception attacks and packet dropouts over multichannel unreliable networks as described in Fig. 1.

The control signals sent by the controller to the plant via multichannel unreliable network are denoted by  $u_k^c = [u_k^{c1} \dots u_k^{ci} \dots u_k^{cq}]^T \in \mathbb{R}^q$  and the unknown signal sent by the adversary to compromise the controlled

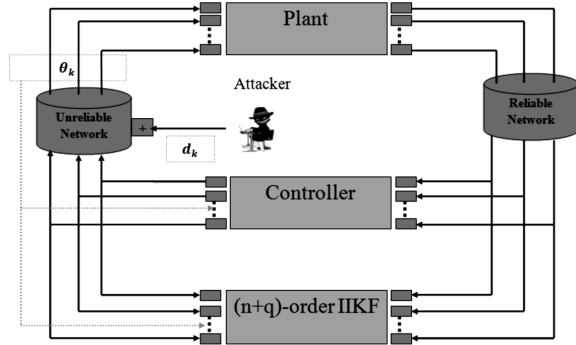

Fig. 1. Deception attack via a multi-channel network.

plant is denoted by  $d_k = [d_k^1 \dots d_k^i \dots d_k^q]^T \in \mathbb{R}^q$ .

The set of binary variables

$$\theta_k = \{\rho_k^1, \dots, \rho_k^i, \dots, \rho_k^q\}$$

represents the acknowledgement signals indicating the status of reception/delivery (e.g., TCP) with  $\rho_k^i = 1$  when  $u_k^{ci}$  is received by the plant or  $\rho_k^i = 0$  when  $u_k^{ci}$  is lost on the  $i$ -th channel of the unreliable network.

From the following logic:

$$u_k^i = (1 - \rho_k^i)u_{k-1}^i + \rho_k^i u_k^{ci}, \quad (4)$$

$u_k^i$  is blocked to the past value  $u_{k-1}^i$  when  $u_k^{ci}$  is lost. Under a deception attack, (4) rewritten in the form  $u_k^i = (1 - \rho_k^i)u_{k-1}^i + \rho_k^i(u_k^{ci} + d_k^i)$  can be expressed as

$$u_k^i = \bar{u}_k^i + \nu_k^i, \quad (5)$$

$$\bar{u}_k^i = (1 - \rho_k^i)\bar{u}_{k-1}^i + \rho_k^i u_k^{ci}, \quad (6)$$

$$\nu_k^i = (1 - \rho_k^i)\nu_{k-1}^i + \rho_k^i d_k^i, \quad (7)$$

where  $\bar{u}_k^i$  given by (6) is known to the controller having access to the binary sequence  $\{\theta_j\}_0^k$  and where  $\nu_k^i$  given by (7) switches between unknown input  $\nu_k^i = d_k^i$  when  $\rho_k^i = 1$  and constant bias  $\nu_k^i = \nu_{k-1}^i$  when  $\rho_k^i = 0$ . By rewriting the hybrid disturbance  $\nu_k = [\nu_k^1 \dots \nu_k^i \dots \nu_k^q]^T$  as a constant bias

$$\nu_k = \nu_{k-1} + d_k^\theta \quad (8)$$

driven by a bias state-dependent intermittent unknown input

$$d_k^\theta = [ \rho_k^1(d_k^1 - \nu_{k-1}^1) \dots \rho_k^i(d_k^i - \nu_{k-1}^i) \dots \rho_k^q(d_k^q - \nu_{k-1}^q) ]^T, \quad (9)$$

we can derive the following  $(n + q)$ -th order linear time-invariant state model of the plant

$$X_{k+1} = \bar{A}X_k + \bar{B}\bar{u}_k + \bar{F}d_k^\theta + \bar{w}_k, \quad (10)$$

$$y_k = \bar{C}X_k + v_k, \quad (11)$$

with

$$X_k = \begin{bmatrix} x_k \\ v_{k-1} \end{bmatrix} \in \mathbb{R}^{n+q},$$

$$\bar{u}_k = [ \bar{u}_k^1 \dots \bar{u}_k^i \dots \bar{u}_k^q ]^T,$$

$$\bar{A} = \begin{bmatrix} A & B \\ 0 & I \end{bmatrix}, \quad \bar{B} = \begin{bmatrix} B \\ 0 \end{bmatrix},$$

$$\bar{F} = \begin{bmatrix} B \\ I \end{bmatrix}, \quad \bar{C} = [ C \ 0 ],$$

$$\bar{w}_k = \begin{bmatrix} w_k \\ 0 \end{bmatrix}, \quad E\{\bar{w}_k \bar{w}_j^T\} = \bar{W} \delta_{k,j},$$

$$\bar{W} = \begin{bmatrix} W & 0 \\ 0 & 0 \end{bmatrix}.$$

To generate the minimum variance unbiased estimate of the augmented state, this paper proposes to design a multi-channel filtering algorithm by using (8), (9), (10) and (11) and the IIKF presented by Keller and Sauter (2013) or in Appendix. Sufficient stochastic stability conditions of the obtained filter are established when packet dropouts follow independent Bernoulli processes with  $\lambda = \Pr[\rho_k^i = 1], \forall i \in [1 \ q]$ , where  $\lambda$  is the rate of data losses.

### 3. State filtering under switching disturbances

In this section, we shall solve the state filtering problem described in Section 2 by designing a multi-channel filtering algorithm that takes into account the interconnection signals between subsystems as intermittent unknown inputs and by applying a modified version of the unknown input Kalman filter to each subsystem. This technique allows the filter to perfectly handle permanent unknown inputs.

**Theorem 1.** *The minimum variance unbiased estimate*

$$\hat{X}_{k/k} = \begin{bmatrix} \hat{x}_{k/k} \\ \hat{v}_{k-1/k} \end{bmatrix}$$

of the state  $X_k$  is generated by the following augmented state intermittent unknown input Kalman (ASIIKF) filter:

$$\hat{X}_{k/k} = (I - \bar{K}_k \bar{C})(\hat{X}_{k/k-1} + \bar{F}_{k-1} \hat{d}_{k-1/k}^\theta) + \bar{K}_k y_k, \quad (12)$$

$$P_{k/k} = (I - \bar{K}_k \bar{C})(P_{k/k-1} + \bar{F}_{k-1} \bar{Q}_{k-1/k}^\theta \bar{F}_{k-1}^T) \times (I - \bar{K}_k \bar{C})^T + \bar{K}_k \bar{K}_k^T, \quad (13)$$

$$\hat{X}_{k+1/k} = \bar{A} \hat{X}_{k/k} + \bar{B} \bar{u}_k, \quad (14)$$

$$P_{k+1/k} = \bar{A}P_{k/k}\bar{A}^T + \bar{W}, \quad (15)$$

$$\hat{d}_{k-1/k}^\theta = \bar{G}_k(y_k - \bar{C}\hat{X}_{k/k-1}), \quad (16)$$

$$\bar{Q}_{k-1/k}^\theta = [(\bar{C}\bar{F}_{k-1})^T(\bar{C}P_{k/k-1}\bar{C}^T + I)^{-1}\bar{C}\bar{F}_{k-1}]^+ \quad (17)$$

with

$$\bar{K}_k = P_{k/k-1}\bar{C}^T(\bar{C}P_{k/k-1}\bar{C}^T + I)^{-1}, \quad (18)$$

$$\bar{G}_k = \bar{Q}_{k-1/k}(\bar{C}\bar{F}_{k-1})^T(\bar{C}P_{k/k-1}\bar{C}^T + I)^{-1}, \quad (19)$$

$$\bar{F}_k = \begin{bmatrix} B_k \\ I_k \end{bmatrix}, \quad (20)$$

$$B_k = [ \rho_k^1 B^1 \quad \dots \quad \rho_k^i B^i \quad \dots \quad \rho_k^q B^q ],$$

$$I_k = \text{diag}[ \rho_k^1 \quad \rho_k^i \quad \rho_k^q ], \quad (21)$$

where  $X^+$  in (17) is the Moore–Penrose inverse of  $X$ . Under the necessary and sufficient condition

$$\text{rank} \begin{bmatrix} -Iz + \bar{A} & \bar{F} \\ \bar{C} & 0 \end{bmatrix} = n + 2q, \quad \forall |z| \geq 1, \quad (22)$$

we have

$$\lim_{k \rightarrow \infty} E \{ P_{k+1/k} \} < \infty, \quad \forall \lambda \in [0 \ 1], \quad (23)$$

where  $E \{ P_{k+1/k} \}$  is the mathematical expectation of  $P_{k+1/k}$  with respect to  $\{\theta_j\}_0^k$ .

*Proof.* Consider the following linear state filter

$$\hat{X}_{k/k} = \hat{X}_{k/k-1} + K_k(y_k - \bar{C}\hat{X}_{k/k-1}), \quad (24)$$

$$P_{k/k} = (I - K_k\bar{C})P_{k/k-1}(I - K_k\bar{C})^T + K_k K_k^T, \quad (25)$$

$$\hat{X}_{k+1/k} = \bar{A}\hat{X}_{k/k} + \bar{B}\bar{u}_k, \quad (26)$$

$$P_{k+1/k} = \bar{A}P_{k/k}\bar{A}^T + \bar{W}, \quad (27)$$

where  $\hat{X}_{k/k-1}$  is the state prediction of covariance

$$P_{k/k-1} = E \{ (X_k - \hat{X}_{k/k-1})(X_k - \hat{X}_{k/k-1})^T \}$$

based on measurements available until time  $k - 1$  and  $\{\theta_j\}_0^{k-1}$ ,  $\hat{X}_{k/k}$  signifies the state estimate of covariance matrix

$$P_{k/k} = E \{ (X_k - \hat{X}_{k/k})(X_k - \hat{X}_{k/k})^T \}$$

based on measurements available until time  $k$  and  $\{\theta_j\}_0^k$ . The state prediction error  $e_{k/k-1} = X_k - \hat{X}_{k/k-1}$  and the state estimation error  $e_{k/k} = X_k - \hat{X}_{k/k}$  propagate as

$$e_{k/k-1} = \bar{A}e_{k-1/k-1} + \bar{F}d_{k-1}^\theta + \bar{w}_{k-1}, \quad (28)$$

$$e_{k/k} = (I - K_k\bar{C})e_{k/k-1} - K_kv_k. \quad (29)$$

Under

$$E \{ e_{k-1/k-1} \} = 0,$$

we have

$$E \{ e_{k/k-1} \} = \bar{F}d_{k-1}^\theta, \quad E \{ e_{k/k} \} = 0$$

if and only if  $K_k$  satisfies  $(I - K_k\bar{C})\bar{F}d_{k-1}^\theta = 0$  or, equivalently,

$$(I - K_k\bar{C})\bar{F}_{k-1} = 0. \quad (30)$$

Instead of using the parameterized approach proposed by Darouach and Zasadzinski (1997) to minimize  $\text{tr}(P_{k/k})$  with respect to  $K_k$  subject to (30) which requires off-line precomputation of the structure of  $K_k$  for each combinatorial situation of the binary sequence  $\theta_{k-1} = \{\rho_{k-1}^1, \dots, \rho_{k-1}^i, \dots, \rho_{k-1}^q\}$ , the solution to (30) is parameterized from two constant size matrices  $\bar{K}_k$  and  $\bar{G}_k$  as  $K_k = \bar{K}_k + (I - \bar{K}_k\bar{C})\bar{F}_{k-1}\bar{G}_k$ . The free gain  $\bar{K}_k$  and the constrained gain  $\bar{G}_k$ , obtained by minimizing the trace of the state-estimation-error covariance matrix and the trace of the unknown-input-estimation error covariance matrix, are given by (18) and (19), respectively. The covariance  $P_{k+1/k}$  of the hybrid Riccati difference equation (HRDE)

$$P_{k+1/k} = (\bar{A} - \bar{A}K_k\bar{C})P_{k/k-1}(\bar{A} - \bar{A}K_k\bar{C})^T + \bar{A}K_k K_k^T \bar{A}^T + \bar{W} \quad (31)$$

satisfies  $P_{k+1/k} \leq \hat{P}_{k+1/k} \forall \{\theta_j\}_0^k$ , where  $\hat{P}_{k+1/k}$  is a solution to the ASIIF's RDE under  $\theta_k = \{1, \dots, 1, \dots, 1\}$ ,  $\forall k$ , or equivalently a solution to the standard UIKF's RDE defined by Darouach and Zasadzinski (1997) as

$$\hat{P}_{k+1/k} = (\hat{A} - \hat{K}_k\hat{C})\hat{P}_{k/k-1}(\hat{A} - \hat{K}_k\hat{C})^T + \hat{K}_k\hat{K}_k^T + \hat{W} \quad (32)$$

with

$$\hat{K}_k = \hat{A}\hat{P}_{k/k-1}\hat{C}^T(\hat{C}\hat{P}_{k/k-1}\hat{C}^T + \Sigma\Sigma^T)^{-1},$$

$$\hat{A} = \bar{A} - \bar{A}\bar{F}(\bar{C}\bar{F})^+\bar{C},$$

$$\hat{C} = \Sigma\bar{C},$$

$$\Sigma = \beta(I - \bar{C}\bar{F}(\bar{C}\bar{F})^+),$$

$\beta \in \mathbb{R}^{m-q,m}$  so that  $\text{rank}(\Sigma) = m - q$  and  $\hat{W} = \bar{W} + \bar{A}\bar{F}(\bar{C}\bar{F})^+(\bar{C}\bar{F})^T(\bar{A}\bar{F})^T$ . Under (18), the pair  $(\hat{A}, \hat{C})$  is detectable and

$$\lim_{k \rightarrow \infty} P_{k+1/k} \leq \lim_{k \rightarrow \infty} \hat{P}_{k+1/k} < \infty, \quad \forall \{\theta_k\}_0^\infty$$

leads to (23). ■

Let

$$\vartheta = \{\theta^0, \dots, \theta^j, \dots, \theta^{N-1}\}$$

be the set of  $N = 2^q$  different binary situations of  $\theta_k = \{\rho_k^1, \dots, \rho_k^i, \dots, \rho_k^q\}$ ,

$$\sigma_k = \{\sigma_k^0, \dots, \sigma_k^j, \dots, \sigma_k^{N-1}\}$$

the set of binary variables defined by  $\sigma_k^j = 1$  when  $\theta_k = \theta^j$  or  $\sigma_k^j = 0$  when  $\theta_k \neq \theta^j$ ,  $r_j$  the number of one in  $\theta^j$ ,  $p_j = \lambda^{r_j}(1-\lambda)^{q-r_j}$  the probability of the event  $\sigma_k^j = 1$ ,  $\bar{F}^j$  the nonzero columns of  $\bar{F}_k$  when  $\sigma_k^j = 1$  and, finally,  $(\bar{A}^j, \bar{C}^j)$  the pair associated with  $\sigma_k^j$  with  $\bar{A}^j = \bar{A} - \bar{A}\bar{F}^j(\bar{C}\bar{F}^j)^+ \bar{C}$ ,  $\bar{C}^j = \Sigma^j \bar{C}$  and  $\Sigma^j = \beta_j(I - \bar{C}\bar{F}^j(\bar{C}\bar{F}^j)^+)$  with  $\beta_j \in \mathbb{R}^{m-r_j, m}$  so that  $\text{rank}(\Sigma^j) = m - r_j$ .

**Theorem 2.** Under the necessary condition

$$p_j \rho(\bar{A}^j)^2 \leq 1, \quad \forall j \in \{0, 1, \dots, N-1\}, \quad (33)$$

where  $\rho(\bar{A}^j)$  is the spectral radius of the unobservable modes of the pair  $(\bar{A}^j, \bar{C}^j)$ , if there exists  $\bar{K}^j \in \mathbb{R}^{n+q, m-r_j}$  and  $\bar{Y} \in \mathbb{R}^{n+q, n+q}$  with  $0 < \bar{Y} \leq I$  so that  $\Psi_\lambda(\bar{Y}, \bar{K}^0, \bar{K}^1, \dots, \bar{K}^{N-1}) > 0$ , where

$$\Psi_\lambda(\bar{Y}, \bar{K}^0, \bar{K}^1, \dots, \bar{K}^{N-1}) = \begin{bmatrix} \bar{Y} & \sqrt{p_0} \bar{\Omega}^0 & \sqrt{p_1} \bar{\Omega}^1 \\ \sqrt{p_0} \bar{\Omega}^{0T} & \bar{Y} & 0 \\ \sqrt{p_1} \bar{\Omega}^{1T} & 0 & \bar{Y} \\ \vdots & \vdots & \vdots \\ \sqrt{p_{N-1}} \bar{\Omega}^{N-1T} & 0 & 0 \\ \dots & \sqrt{p_{N-1}} \bar{\Omega}^{N-1} \\ \dots & 0 \\ \dots & 0 \\ \vdots \\ \dots & \bar{Y} \end{bmatrix} \quad (34)$$

with  $\bar{\Omega}^j = \bar{Y} \bar{A}^j + \bar{K}^j \bar{C}^j$ , then

$$\lim_{k \rightarrow \infty} E \{P_{k/k-1}\} < \infty, \quad \forall \lambda \in [0, \hat{\lambda}_c], \quad (35)$$

where

$$\hat{\lambda}_c = \arg \left\{ \max_{\lambda} \Psi_\lambda(\bar{Y}, \bar{K}^0, \bar{K}^1, \dots, \bar{K}^{N-1}) > 0 \right\} \quad (36)$$

is the lower bound of the unknown critical arrival rate  $\lambda_c$  of packet losses defined as

$$\lim_{k \rightarrow \infty} E \{P_{k+1/k}\} \begin{cases} \rightarrow \infty & \text{if } \lambda > \lambda_c, \\ < \infty & \text{if } \lambda \leq \lambda_c. \end{cases}$$

*Proof.* Define the Riccati operator

$$f^j(X) = \bar{A}^j X \bar{A}^{jT} + \bar{W}^j - \bar{A}^j X \bar{C}^{jT} (\bar{C}^j X \bar{C}^{jT} + \bar{V}^j)^{-1} \bar{C}^j X \bar{A}^{jT} \quad (37)$$

with

$$\bar{V}^j = \Sigma^j \Sigma^{jT}, \\ \bar{W}^j = \bar{W} + \bar{A} \bar{F}^j (\bar{C} \bar{F}^j)^+ (\bar{C} \bar{F}^j)^{+T} (\bar{A} \bar{F}^j)^T.$$

From the appendix in the work of Keller and Sauter (2013), the HRDE (31) can be expressed as a switching Riccati difference equation (SRDE)

$$P_{k+1/k} = \sum_{j=0}^{N-1} \sigma_{k-1}^j f^j(P_{k/k-1}) \quad (38)$$

and

$$E \{P_{k+1/k}\} = \sum_{j=0}^{N-1} p_j E \{f^j(P_{k/k-1})\} \quad (39)$$

The Riccati operator  $f^j(X)$  is concave, increases with  $X$  and Jensen's inequality gives

$$E \{P_{k+1/k}\} \leq \sum_{j=0}^{N-1} p_j f^j(E \{P_{k/k-1}\}).$$

A deterministic upper bounded  $S_{k+1}$  of  $E \{P_{k+1/k}\}$  so that  $E \{P_{k+1/k}\} \leq S_{k+1}$  is then generated, with  $S_0 = P_0 \geq 0$ , by the modified RDE

$$S_{k+1} = \sum_{j=0}^{N-1} p_j f^j(S_k). \quad (40)$$

The first part of the proof shows that (33) represents the necessary existence conditions for a stabilizing solution to the modified algebraic Riccati difference equation (ARDE)

$$S = \sum_{j=0}^{N-1} p_j f^j(S). \quad (41)$$

By letting

$$f_\lambda^j(S_k) = \tilde{A}^j S_k \tilde{A}^j + \tilde{W}^j - \tilde{A}^j S_k \tilde{C}^{jT} (\tilde{C}^j S_k \tilde{C}^{jT} + \tilde{V}^j)^{-1} \tilde{C}^j S_k \tilde{A}^{jT} \quad (42)$$

with  $\tilde{A}^j = \sqrt{p_j} \bar{A}^j$  and  $\tilde{W}^j = p_j \bar{W}^j$  or

$$f_\lambda^j(S_k) = (\tilde{A}^j - \tilde{K}_k^j \tilde{C}^j) S_k (\tilde{A}^j - \tilde{K}_k^j \tilde{C}^j)^T + \tilde{K}_k^j \tilde{V}^j \tilde{K}_k^{jT} + \tilde{W}^j \quad (43)$$

with  $\bar{K}_k^j = \tilde{A}^j S_k \bar{C}^{jT} (\bar{C}^j S_k \bar{C}^{jT} + \bar{V}^j)^{-1}$ , the modified RDE (40) is rewritten as

$$S_{k+1} = \sum_{j=0}^{N-1} f_{\lambda}^j(S_k). \tag{44}$$

From (43), we have  $f_{\lambda}^i(S_k) \geq 0$ . By letting  $f_{\lambda}^j(S_k) = 0, \forall j \in \{0, \dots, i-1, i+1, \dots, N-1\}$ , in (44), the obtained relation  $S_{k+1}^i = f_{\lambda}^i(S_k^i)$  with  $S_0^i = S_0 \geq 0$  generates a lower bound  $S_{k+1}^i$  of  $S_{k+1}$ . From  $S_{k+1}^i \leq S_{k+1}$  we deduce that a stabilizing solution to the modified ARDE (41) cannot exist as  $\lim_{k \rightarrow \infty} S_{k+1}^i \rightarrow \infty$ . Necessary conditions for a stabilizing solution to the modified ARDE (41) are that  $(\sqrt{p_j} \bar{A}^j, \bar{C}^j)$  be detectable for each  $j \in \{0, \dots, N-1\}$ , which is rewritten as  $p_j \rho(\bar{A}^j)^2 \leq 1, \forall j \in \{0, 1, \dots, N-1\}$  from the spectral radius  $\rho(\bar{A}^j)$  of the unobservable modes of the pair  $(\bar{A}^j, \bar{C}^j)$ .

The second part of the proof directly follows the one for the stochastic stability of the Kalman filter with intermittent observations established in (Liu and Goldsmith, 2004; Sinopoli et al., 2004).

Let

$$g_{\lambda}(X) = \sum_{j=0}^{N-1} p_j f^j(X)$$

and consider the auxiliary function

$$\begin{aligned} \Phi_{\lambda}(X) = \sum_{j=0}^{N-1} p_j [ & (\bar{A}^j - \bar{K}^j \bar{C}^j) X (\bar{A}^j - \bar{K}^j \bar{C}^j)^T \\ & + \bar{K}^j \bar{V}^j \bar{K}^{jT} + \bar{W}^j ] \end{aligned} \tag{45}$$

satisfying  $g_{\lambda}(X) \leq \Phi_{\lambda}(X), \forall \bar{K}^j \in \mathbb{R}^{n+q, m-r_j}$  for  $j \in \{0, \dots, N-1\}$ . If there exists  $\bar{K}^j \in \mathbb{R}^{n+q, m-r_j}$  for  $j \in \{0, \dots, N-1\}$  and  $X > 0$  so that  $X > \Phi_{\lambda}(X)$ , then there exists a unique stabilizing solution  $S \geq 0$  to the modified ARDE (41). The following statements are equivalent (Liu and Goldsmith, 2004):

- $\exists \bar{K}^j \in \mathbb{R}^{n+q, m-r_j}$  for  $j \in \{0, \dots, N-1\}$  and  $X > 0$  so that  $X > \Phi_{\lambda}(X)$ .
- $\exists \bar{K}^j \in \mathbb{R}^{n+q, m-r_j}$  for  $j \in \{0, \dots, N-1\}$  and  $0 < \bar{Y} \leq I$  so that  $\Psi_{\lambda}(\bar{Y}, \bar{K}^0, \bar{K}^1, \dots, \bar{K}^{N-1}) > 0$ .

### 4. Numerical examples

In this section we apply our approach to an NCS in the case of a minimum phase and a non-minimum phase plant.

**4.1. Case 1: The minimum phase plant.** Consider first the following minimum phase plant, leading to the representation shown in Fig. 1:

$$\begin{aligned} A &= \begin{bmatrix} 0.3 & 0 & 0.2 & 0.35 \\ 0 & 0.8 & 0 & 0.2 \\ 0 & 0 & 0.5 & 0 \\ 0 & 0 & 0 & 0.4 \end{bmatrix}, \\ B &= \begin{bmatrix} 1 & 0 & 0 \\ 1 & 0 & 1 \\ 0 & 0 & 2 \\ 0 & 1 & 1 \end{bmatrix}, \\ C &= \begin{bmatrix} 1 & 0 & 0 & 0 \\ 0 & 1 & 0 & 0 \\ 0 & 0 & 0 & 1 \end{bmatrix}, \quad W = 0.01I, \end{aligned}$$

where the rank condition (22) holds (the plant has one real stable invariant zero at 0.9).

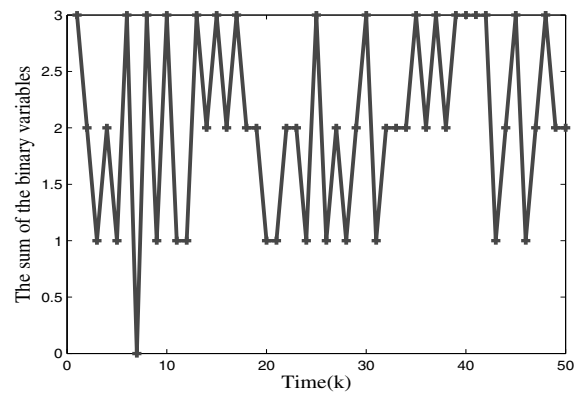

Fig. 2. Sum of the binary variables  $\rho_k^1 + \rho_k^2 + \rho_k^3$ .

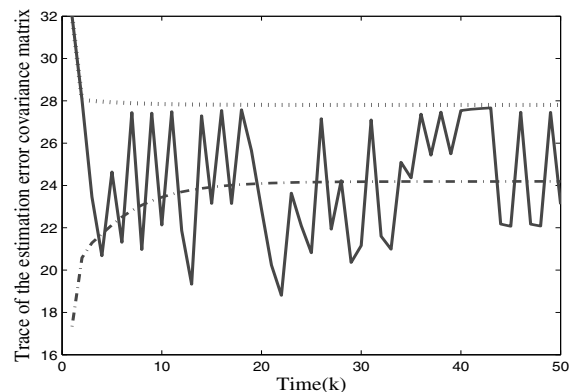

Fig. 3. Evolution of  $\text{tr}(P_{k/k-1})$  (solid line),  $\text{tr}(\hat{P}_{k/k-1})$  (dotted line) and  $\text{tr}(S_k)$  (dash-dotted line).

The sum of the binary variables  $\rho_k^1$ ,  $\rho_k^2$  and  $\rho_k^3$  with  $\lambda = \Pr[\rho_k^i = 1] = 0.4 \forall i \in [1 \ 3]$  is plotted in Fig. 2. Figure 3 shows that

$$\text{tr}(P_{k/k-1}) \leq \text{tr}(\widehat{P}_{k/k-1})$$

with  $\widehat{P}_{k/k-1}$  generated by (32) and the upper bound  $\text{tr}(S_k)$  of  $\text{tr}(E\{P_{k/k-1}\})$  with  $S_k$  generated by (40).

The time evolutions of the switching disturbance  $\nu_k^1$ ,  $\nu_k^2$ ,  $\nu_k^3$  and their estimates  $\hat{\nu}_{k-1/k}^1$ ,  $\hat{\nu}_{k-1/k}^2$ ,  $\hat{\nu}_{k-1/k}^3$  are displayed in Fig. 4. Figure 5 shows the estimate  $\hat{\nu}_{k-1/k}^i$  of  $\nu_k^i$  generated by the standard ASUIKF (derived from the ASIIKF of Theorem 1 with  $\rho_k^i = 1, \forall i \in [1 \ 3]$ ).

Comparing Figs. 4 and 5, we find that the estimates of the switching disturbances  $\nu_k^1$ ,  $\nu_k^2$  and  $\nu_k^3$  obtained by the ASIIKF of Theorem 1 yield better filtering results than the ASUIKF, especially when the unknown inputs are transformed to constant biases at the occurrence of packet dropouts.

#### 4.2. Case 2: The non-minimum phase plant.

Consider now the non-minimum phase plant

$$A = \begin{bmatrix} 0.9 & 0 & 0.34 & 0.35 \\ 0 & 0.8 & 0 & 0.37 \\ 0 & 0 & 0.5 & 0 \\ 0 & 0 & 0 & 0.9 \end{bmatrix},$$

$$B = \begin{bmatrix} 1 & 0 & 0 \\ 1 & 0 & 1 \\ 0 & 0 & 2 \\ 0 & 1 & 1 \end{bmatrix},$$

$$C = \begin{bmatrix} 1 & 0 & 0 & 0 \\ 0 & 1 & 0 & 0 \\ 0 & 0 & 0 & 1 \end{bmatrix}, \quad W = 0.01I,$$

where (22) does not hold (the plant has one real unstable invariant zero at 1.18). The lower bound of  $\lambda_c$  being the solution to (36) gives  $\widehat{\lambda} = 0.9$ .

The sum of the binary variables  $\rho_k^1$ ,  $\rho_k^2$  and  $\rho_k^3$  with  $\lambda = \Pr[\rho_k^i = 1] = 0.4, \forall i \in [1 \ 3]$  is plotted in Fig. 6. Figure 7 shows  $\text{tr}(P_{k/k-1})$  and the upper bound  $\text{tr}(S_k)$  of  $\text{tr}(E\{P_{k/k-1}\})$ . The time evolutions of the switching disturbance  $\nu_k^1$ ,  $\nu_k^2$ ,  $\nu_k^3$  and their estimates  $\hat{\nu}_{k-1/k}^1$ ,  $\hat{\nu}_{k-1/k}^2$ ,  $\hat{\nu}_{k-1/k}^3$  are plotted in Fig. 8.

For non-minimum phase systems, the unstable invariant zeros of the plant become the unobservable modes of the pair  $(\widehat{A}, \widehat{C})$  and the ARDE associated with the RDE (32) has no stabilizing solution. In other words, a comparative study between ASIIKF and ASUIKF is here impossible.

To quantify which is not really discussed in this paper, but constitutes the main practical application of this

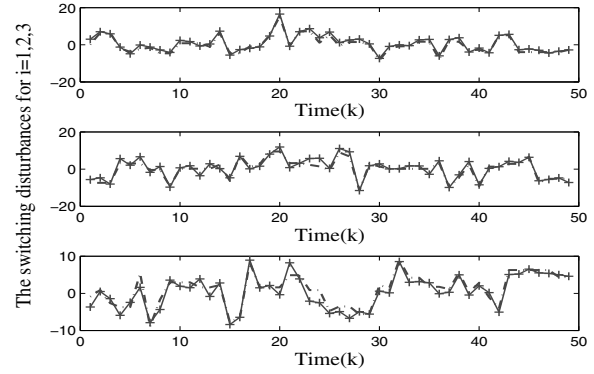

Fig. 4. Time evolution of the switching disturbance  $\nu_k^i$  (dash-dotted line) and its estimate  $\hat{\nu}_{k-1/k}^i$  (solid line).

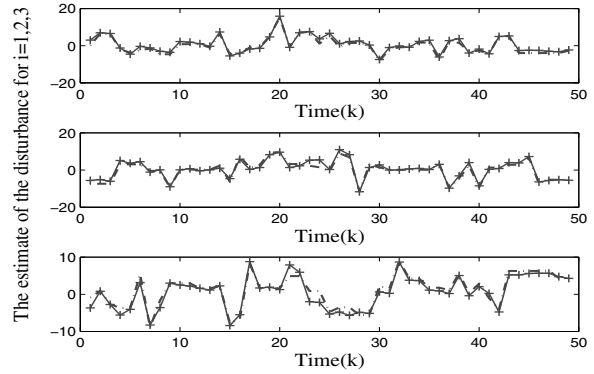

Fig. 5. Estimate of the disturbance  $\hat{\nu}_{k-1/k}^i$  (dash-dotted line) generated by the standard ASUIKF (solid line).

work, is the augmented state estimate

$$\hat{X}_{k/k} = \begin{bmatrix} \hat{x}_{k/k} \\ \hat{\nu}_{k-1/k} \end{bmatrix}$$

of the covariance

$$P_{k/k} = \begin{bmatrix} P_{k/k}^x & \times \\ \times & P_{k-1/k}^\nu \end{bmatrix}$$

given by the ASIIKF. It should be used to monitor the occurrence of deception attacks in the case of the non-minimum phase plant (extremely vulnerable to such an attack) from a bank of statistical decision tests, the  $i$ -th detector of the bank designed on the  $i$ -th normalized switching disturbance estimate  $\hat{\nu}_{k-1/k}^{ni} = (P_{k-1/k}^{\nu i})^{-1/2} \hat{\nu}_{k-1/k}^i$  with  $\hat{\nu}_{k-1/k}^i$  the  $i$ -th component of  $\hat{\nu}_{k-1/k}$  and  $P_{k-1/k}^{\nu i}$  the  $i$ -th element on the diagonal part of  $P_{k-1/k}^\nu$ .



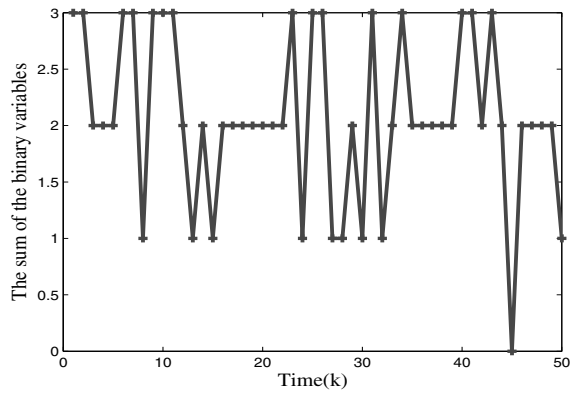

Fig. 6. Sum of the binary variables  $\rho_k^1 + \rho_k^2 + \rho_k^3$ .

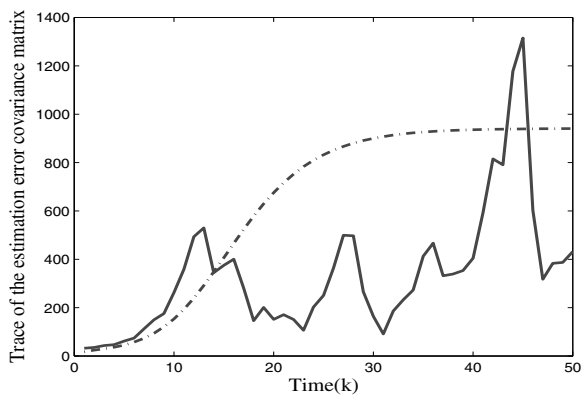

Fig. 7. Evolution of  $\text{tr}(P_{k/k-1})$  (solid line) and  $\text{tr}(S_k)$  (dash-dotted line).

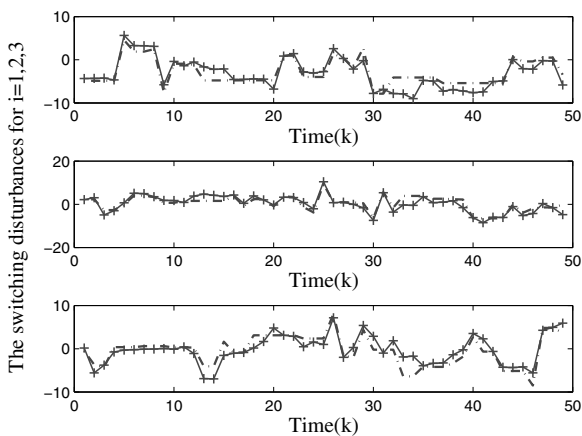

Fig. 8. Evolution of the switching disturbance  $\nu_k^i$  (dash-dotted line) and its estimate  $\hat{\nu}_{k-1/k}^i$  (solid line).

### 5. Conclusion

This paper has presented a state filtering strategy for networked control systems subject to false data injections on the control signals transmitted by the controller to the plant via unreliable multichannel networks. The unknown input induced by the false data injection, transformed to a constant bias at each occurrence time of packet dropout, has been estimated using an intermittent unknown input Kalman filter. The stochastic stability conditions of the filter, which is time-invariant due to its design model obtained by forcing the unknown input to be the complementary state of the bias, have been established when the arrival binary sequence of data losses follows a Bernoulli random process. Contrary to the traditional unknown input Kalman filter, we have shown that the obtained filter can be used to estimate the state of non-minimum phase stochastic discrete-time systems.

### References

Alouani, A., Rice, T. and Blair, W. (1992). A two-stage filter for state estimation in the presence of dynamical stochastic bias, *Proceedings of the American Control Conference, Chicago, IL, USA*, pp. 1784–1788.

Amin, S., Cárdenas, A.A. and Sastry, S.S. (2009). Safe and secure networked control systems under denial-of-service attacks, *Proceedings of the 12th International Conference on HSCC '09, San Francisco, CA, USA*, pp. 31–45.

Ben Hmida, F., Khémiri, K., Ragot, J. and Gossa, M. (2010). Robust filtering for state and fault estimation of linear stochastic systems with unknown disturbance, *Mathematical Problems in Engineering* **2010**, Article ID: 591639.

Bixiang, T., Alvergue, L. and Guoxiang, G. (2015). Secure networked control systems against replay attacks without injecting authentication noise, *Proceedings of the American Control Conference, Chicago, IL, USA*, pp. 6028–6033.

Blanke, M., Kinnaert, M., Lunze, J., Staroswiecki, M. and Schröder, J. (2006). *Diagnosis and Fault-Tolerant Control*, Springer, New York, NY.

Censi, A. (2011). Kalman filtering with intermittent observations: Convergence for semi-Markov chains and an intrinsic performance measure, *IEEE Transactions on Automatic Control* **56**(2): 376–381.

Chabir, K., Sauter, D., Al-Salami, I.-M. and Abdelkrim, M.-N. (2010). Two-stage Kalman filter for simultaneous fault and delay estimation in networked control systems, *Proceedings of the 18th Mediterranean Conference on Control and Automation, Marrakech, Morocco*, pp. 249–254.

Chabir, K., Sauter, D., Ben Gayed, M.-K. and Abdelkrim, M.-N. (2008). Design of an adaptive Kalman filter for fault detection of networked control systems, *Proceedings of the 16th Mediterranean Conference on Control and Automation, Ajaccio, France*, pp. 1124–1129.

- Chabir, K., Sid, M.A. and Sauter, D. (2014). Fault diagnosis in a networked control system under communication constraints: A quadrotor application, *International Journal of Applied Mathematics and Computer Science* **24**(4): 809–820, DOI: 10.2478/amcs-2014-0060.
- Chen, J. and Patton R.J. (1996). Optimal filtering and robust fault diagnosis of stochastic systems with unknown disturbances, *IEE Proceedings—Control Theory and Applications* **143**(1): 31–36.
- Darouach, M. and Zasadzinski, M. (1997). Unbiased minimum variance estimation for systems with unknown exogenous inputs, *Automatica* **33**(4): 717–719.
- Darouach, M., Zasadzinski, M. and Keller, J. (1992). State estimation for discrete systems with unknown inputs using state estimation of singular systems, *Proceedings of the American Control Conference, Chicago, IL, USA*, pp. 3014–3015.
- Fang, H., Shi, Y. and Yi, J. (2011). On stable simultaneous input and state estimation for discrete-time linear systems, *International Journal of Adaptive Control and Signal Processing* **25**(8): 671–686.
- Friedland, B. (1969). Treatment of bias in recursive filtering, *IEEE Transactions on Automatic Control* **14**(4): 359–367.
- Gillijns, S. and De Moor, B. (2007). Unbiased minimum-variance input and state estimation for linear discrete-time systems with direct feedthrough, *Automatica* **43**(5): 934–937.
- Hespanha, J.P., Naghshtabrizi, P. and Xu, Y. (2007). A survey of recent results in networked control systems, *Proceedings of the IEEE* **95**(1): 138.
- Hou, M. and Patton, R. (1998). Optimal filtering for systems with unknown inputs, *IEEE Transactions on Automatic Control* **43**(3): 445–449.
- Hsieh, C.-S. and Chen, F.-C. (1999). Optimal solution of the two-stage Kalman estimator, *IEEE Transactions on Automatic Control* **44**(1): 194–199.
- Kailath, T., Sayed, A.H. and Hassibi, B. (2000). *Linear Estimation*, Prentice-Hall, Englewood Cliffs, NJ.
- Keller, J.-Y., Chabir, K. and Sauter, D. (2016). Input reconstruction for networked control systems subject to deception attacks and data losses on control signals, *International Journal of Systems Science* **47**(4): 814–820.
- Keller, J.-Y. and Sauter, D. (2011). Restricted diagonal detection filter and updating strategy for multiple fault detection and isolation, *International Journal of Adaptive Control and Signal Processing* **25**(1): 68–87.
- Keller, J.-Y. and Sauter, D. (2013). Kalman filter for discrete-time stochastic linear systems subject to intermittent unknown inputs, *IEEE Transactions on Automatic Control* **58**(7): 1882–1887.
- Kim, K.H., Lee, J.G. and Park, C.G. (2006). Adaptive two-stage Kalman filter in the presence of unknown random bias, *International Journal of Adaptive Control and Signal Processing* **20**(7): 305–319.
- Kim, Y. and Park, J. (2003). Noise response of detection filters: Relation between detection space and completion space, *IEE Proceedings—Control Theory and Applications* **150**(4): 443–447.
- Kitanidis, P. K. (1987). Unbiased minimum-variance linear state estimation, *Automatica* **23**(6): 775–778.
- Liu, X. and Goldsmith, A. (2004). Kalman filtering with partial observation losses, *Proceedings of the 43rd IEEE Conference on Decision and Control, Nassau, The Bahamas, Vol. 4*, pp. 4180–4186.
- Liu, Y., Ning, P. and Reiter, M.K. (2009). False data injection attacks against state estimation in electric power grids, *Proceedings of the 16th ACM Conference on Computer and Communications Security, New York, NY, USA*, pp. 21–32.
- Mo, Y. and Sinopoli, B. (2009). Secure control against replay attacks, *Proceedings of the 47th Annual Allerton Conference on Communication, Control, and Computing, Monticello, IL, USA*, pp. 911–918.
- Park, J., Halevi, Y. and Rizzoni, G. (1994). A new interpretation of the fault-detection filter. Part 2: The optimal detection filter, *International Journal of Control* **60**(6): 1339–1351.
- Patton, R.J. and Chen, J. (1999). *Robust Model-Based Fault Diagnosis for Dynamic Systems*, Kluwer Academic Publishers, Boston, MA/London.
- Sandberg, H., Amin, S. and Johansson, K. (2015). Cyberphysical security in networked control systems: An introduction to the issue, *IEEE Control Systems Magazine* **35**(1): 20–23.
- Sandberg, H., Amin, S. and Johansson, K. (2016). Detection of intermittent faults for linear stochastic systems subject to time-varying parametric perturbations, *IET Control Theory and Applications* **10**(8): 903–910.
- Schenato, L., Sinopoli, B., Franceschetti, M., Poolla, K. and Sastry, S.S. (2007). Foundations of control and estimation over lossy networks, *Proceedings of the IEEE* **95**(1): 163–187.
- Simon, D. (2006). *Optimal State Estimation: Kalman, H-infinity, and Nonlinear Approaches*, Wiley, Hoboken, NJ.
- Sinopoli, B., Schenato, L., Franceschetti, M., Poolla, K., Jordan, M.I. and Sastry, S.S. (2004). Kalman filtering with intermittent observations, *IEEE Transactions on Automatic Control* **49**(9): 1453–1464.
- Smith, R.S. (2011). A decoupled feedback structure for covertly appropriating networked control systems, *Proceedings of the IFAC World Congress, Milan, Italy*, pp. 90–95.
- Teixeira, A., Sandberg, H. and Johansson, K.H. (2010). Networked control systems under cyber attacks with applications to power networks, *Proceedings of the American Control Conference, Baltimore, MD, USA*, pp. 3690–3696.
- Zhou, D.-H., Shi, J. and He, X. (2014). Review of intermittent fault diagnosis techniques for dynamic systems, *Acta Automatica Sinica* **40**(2): 161–171.

**Karim Chabir** graduated in 2003 from the Higher School of Sciences and Technology of Tunis (ESSTT) in electrical and control engineering. He received his MSc in automatic and intelligent techniques in 2006 from the National Engineering School of Gabes (Tunisia) and a PhD in automatic control from Henri Poincaré University (France) and the University of Gabes in 2011. His research works have been carried out at the Research Center for Automatic Control of Nancy (CRAN) and at the Research Unit of Modeling, Analysis and Control Systems of the National Engineering School of Gabes. He has once been a member of the dependability and system diagnosis group (SURFDIAG). He is now an assistant professor at the National Engineering School of Gabes (ENIG). His current research interests are focused on model-based fault diagnosis and fault-tolerant control with the emphasis on networked control systems.

**Taouba Rhouma** was born in 1989. She received her engineer's degree in electrical and control engineering in 2013 from the National Engineering School of Gabes (ENIG). Since then, she has been working toward her PhD degree in electrical engineering at the Laboratory for Modeling, Analysis and Control of Systems Laboratory (MACS). Her research interests are in fault detection and diagnosis of networked control systems.

**Jean Yves Keller** received his PhD degree in automatic control from the University of Nancy I, France, in 1991. Since 1993, he has been teaching as *Maître de Conférences HC* at the University Institute of Technology Henri Poincaré (IUT de Longwy). He works with the Research Center in Automatic Control of Nancy (CRAN), associated with the French National Center for Scientific Research (CNRS). He obtained his habilitation from University Henri Poincaré, Nancy, in 2003. His main interests include state filtering, fault diagnosis and fault tolerant control for networked controlled systems.

**Dominique Sauter** received his PhD degree in 1991 from Nancy University, France. Since 1993 he has been a full professor at that university, where he teaches automatic control. He has been the head of the Department of Electrical Engineering for 4 years, and is now the vice-dean at the Faculty of Sciences and Technologies. He is a member of the Research Center in Automatic Control of Nancy (CRAN), associated with the French National Center For Scientific Research (CNRS). His current research interests are focused on model-based fault diagnosis and fault tolerant control with the emphasis on networked control systems. The results of his research works have been published in over 50 articles in journals and book contributions as well as 120 conference papers.

## Appendix

The intermittent unknown inputs filter (IIKF) is described as follows. The unbiased minimum variance (UMV) state estimate  $\hat{x}_{k/k}^\theta$  of covariance  $P_{k/k}^\theta$  is generated by the following modified Kalman filter:

$$\hat{x}_{k/k}^\theta = (I - K_k^0 C)(\hat{x}_{k/k-1}^\theta + F_{k-1}^\theta \hat{d}_{k-1/k}^\theta) + K_k^0 y_k, \quad (A1)$$

$$P_{k/k}^\theta = (I - K_k^0 C)(P_{k/k-1}^\theta + F_{k-1}^\theta Q_{k-1/k}^\theta F_{k-1}^{\theta T}) \times (I - K_k^0 C)^T + K_k^0 K_k^{0T}, \quad (A2)$$

$$\hat{x}_{k+1/k}^\theta = A \hat{x}_{k/k}^\theta + B u_k, \quad (A3)$$

$$P_{k+1/k}^\theta = A P_{k/k}^\theta A^T + W, \quad (A4)$$

with  $K_k^0 = P_{k/k-1}^\theta C(C P_{k/k-1}^\theta C^T + I)^{-1}$ , updated on-line from the additive quantities  $F_{k-1}^\theta \hat{d}_{k-1/k}^\theta$  and  $F_{k-1}^\theta Q_{k-1/k}^\theta F_{k-1}^{\theta T}$  depending on the unknown inputs estimate  $\hat{d}_{k-1/k}^\theta$  of covariance  $Q_{k-1/k}^\theta$  given by

$$\hat{d}_{k-1/k}^\theta = G_k^\theta (y_k - C \hat{x}_{k/k-1}^\theta) \quad (A5)$$

$$Q_{k-1/k}^\theta = [(C F_{k-1}^\theta)^T (C P_{k/k-1}^\theta C^T + I)^{-1} C F_{k-1}^{\theta T}]^+ \quad (A6)$$

with

$$G_k^\theta = Q_{k-1/k}^\theta (C F_{k-1}^\theta)^T (C P_{k/k-1}^\theta C^T + I)^{-1}.$$

The  $i$ -th component  $\hat{d}_{k-1/k}^{\theta i}$  represents the estimate of  $\rho_{k-1}^i d_{k-1}^i$  (with  $\hat{d}_{k-1/k}^{\theta i} = 0$  when  $\rho_{k-1}^i = 0$ ) and the  $i$ -th component  $Q_{k-1/k}^{\theta i}$  on the diagonal part of  $Q_{k-1/k}^\theta$  represents the variance of  $\hat{d}_{k-1/k}^{\theta i}$  (with  $Q_{k-1/k}^{\theta i} = 0$  when  $\rho_{k-1}^i = 0$ ). The IIKF is initialized by  $\hat{x}_{0/-1}^\theta = \bar{x}_0$ ,  $P_{0/-1}^\theta = P_0 \geq 0$  and  $\theta_{-1} = \{0, \dots, 0, \dots, 0\}$ .

Received: 20 February 2017

Revised: 24 August 2017

Re-revised: 10 January 2018

Accepted: 4 April 2018