



HAL
open science

Numerical simulation of oil and air two-phase flow in a planetary gear system using the overset mesh technique

Jaeyeol Cho, Nahmkeon Hur, Jongrak Choi, Jiwon Yoon

► To cite this version:

Jaeyeol Cho, Nahmkeon Hur, Jongrak Choi, Jiwon Yoon. Numerical simulation of oil and air two-phase flow in a planetary gear system using the overset mesh technique. 16th International Symposium on Transport Phenomena and Dynamics of Rotating Machinery, Apr 2016, Honolulu, United States. <hal-01894398>

HAL Id: hal-01894398

<https://hal.science/hal-01894398v1>

Submitted on 12 Oct 2018

HAL is a multi-disciplinary open access archive for the deposit and dissemination of scientific research documents, whether they are published or not. The documents may come from teaching and research institutions in France or abroad, or from public or private research centers.

L'archive ouverte pluridisciplinaire **HAL**, est destinée au dépôt et à la diffusion de documents scientifiques de niveau recherche, publiés ou non, émanant des établissements d'enseignement et de recherche français ou étrangers, des laboratoires publics ou privés.



HAL Authorization

Numerical simulation of oil and air two-phase flow in a planetary gear system using the overset mesh technique

Jaeyoul Cho¹, Nahmkeon Hur^{1*}, Jongrak Choi², Jiwon Yoon²



Abstract

Planetary gear systems are widely used in differentials, transmissions and brake systems of many industrial machineries. Often, the components inside such a system are fully or partially submerged in oil, which serves for simultaneous lubrication and cooling. Hence, this oil recirculation is a key element for the durability and performance. The focus of this paper is two-phase flow analysis of a planetary gear system at different initial oil level and, also, its application in a transaxle brake assembly. Usually, due to the complex multi-phase flow phenomena inside the transaxle chambers, their simulation is arduous, and hence, little technical information exist about the details of their multi-phase phenomena. In order to imitate a real case situation, the numerical simulations are solved in an unsteady framework using the Realizable k - ϵ turbulence model together with the volume of fluid (VOF) method. Overset mesh technique is used to simulate the rotating planetary gear and the brake pad, which allows more realistic simulation of gears engagement. The aims are to predict flow characteristics, quality of lubrication and also heat transfer inside the brake during its operation. The results are presented and discussed in terms of lubrication and cooling efficiency. The outcomes can be used to improve the design of existing brake oil lubrication.

Keywords

Planetary gear—Transaxle brake—CFD—Multiphase—Heat transfer—Lubrication

¹ Department of Mechanical Engineering, Sogang University, Seoul, Korea

² Department of Research and Development, LS Mtron, Gunpo, Korea

*Corresponding author: nhur@sogang.ac.kr

INTRODUCTION

Planetary gears are usually used for combination of power shafts with different types of gears which might be used in differentials, transmissions and transaxle brake systems in many machineries, such as automobiles and trains. A planetary gear is composed of a sun gear at the center, planet gears and a ring gear. Often oil is used for the lubrication and cooling of the mechanical parts engaged in the rotation, including gears, brake pads and shafts. Since, the mechanical part might be partially submerged in the oil, the oil and air form two-phase phenomena, which are rather impossible to be fully predicted and understood without numerical simulations. In this case CFD method can be an appropriate solution.

Tadashi Yamada [1] simulated thermal characteristics of the the coolant inside of the powertrain. He predicted oil and air multiphase flow characteristics and conjugate heat transfer using a mesh regeneration method for rotating gears and VOF (Volume of Fluid) method. This numerical method was validated by comparing with experimental data, and the results were used for improving powertrain performance and efficiency. Yazdani and Soteriou [2] studied oil jet effect at the simple 2D gear system using a mesh regeneration technique and VOF method. They compared cooling efficiency of oil according to velocity of oil jet. Stosic [3] investigated oil and air multiphase flow and temperature characteristic inside of compressor using screw gears. Similar to the previous works, mesh regeneration method and VOF method were applied. Nirvesh Mehtha et al. [4] simulated oil flow inside a gearbox containing three axes and ten gears using Multiple Reference

Frame (MRF) method for 3D rotating gears. Because of limitation in the MRF method, their simulations did not include the overlapped regions of the rotating gears. Li Li et al. [5] investigated relation between oil churning loss and oil level by gear simulation using mesh regeneration method.

Based on the difficulties and limitations of the existing numerical techniques, simulation of a compact rotating gear system in the presence of circulating oil and considering heat transfer problem in a single framework needs a very high computational resource. In addition, these kinds of simulations have to be carried out using unsteady multiphase flow assumptions. Furthermore, an appropriate mesh technique with sufficient mesh resolution is required, which usually results in a larger number of computational cells, which has been a drawback for many scholars. Moreover, the MRF method which is usually used for the simulations is not inherently appropriate for these simulations, which is due to the fact that MRF requires some simplifications in the overlapped regions, which causes considerable discrepancies between the simulations and the experiments. Hence, a few comprehensive sources and reports are available, in which all of the previous important simulation parameters are appropriately considered.

This research aims at investigation of the effects of initial oil level in planetary gear and unsteady heat transfer and oil circulation inside a transaxle brake. To do so, first, the required mesh resolution for overset mesh technique and other necessary CFD factors such as timestep are investigated during the planetary gear simulation. Later, the transaxle is simulated taking into account the results of the planetary simulations, and the predictions about the two-phase interaction

of the oil and air, in the presence of heat transfer are investigated. The study is carried out using a commercial CFD solver, STAR-CCM+ V 10.02 on the computer cluster of CFD-ERC of Sogang University, Korea. The typical solution times for the planetary gear and transaxle are 90 hours and 180 hour using 80 cores (Intel Xeon E5-2660 v2, 2.20 GHz CPUs).

1. GOVERNING EQUATIONS

The numerical simulations consider the mass and momentum conservation equations for incompressible flows. In addition, for the pressure and velocity coupling, the SIMPLE scheme is adopted. This scheme consider relation between velocity and pressure correlations to enforce mass conservation and to obtain pressure distribution. The mass conservation equations can be expressed as:

$$\frac{\partial}{\partial x_j}(\rho u_j) = 0 \quad (1)$$

The momentum conservation equation is :

$$\frac{\partial \rho u_i}{\partial t} + \frac{\partial}{\partial x_j}(\rho u_j u_i - \tau_{ij}) = -\frac{\partial p}{\partial x_i} + s_i \quad (2)$$

The VOF method is used for oil and air multiphase flow simulation. This model considers the volume fraction for each fluid and tracks free surface of the immiscible fluid regions. The location of interface between oil and air can be determined from the distribution of volume fraction in domain. Fluid properties such as density and viscosity are calculated based on volume fractional average.

The equations physical properties are calculated as :

$$\rho = \sum_i \rho_i \phi_i \quad (3 - a)$$

$$\mu = \sum_i \mu_i \phi_i \quad (3 - b)$$

$$c_p = \sum_i \frac{(c_p)_i \rho_i}{\rho} \phi_i \quad (3 - c)$$

where ϕ_i is the volume fraction of phase I; and evidently:

$$\sum \phi_i = 1 \quad (4)$$

The conservation equation for the volume fraction of one phase is written by:

$$\begin{aligned} \frac{\partial}{\partial t} \int_V \phi_i dV + \int_S \phi_i (v - v_g) \cdot da \\ = \int (s_{\phi_i} - \frac{\phi_i}{\rho_i} \frac{D\rho_i}{Dt}) dV \end{aligned} \quad (5)$$

Because of fast rotating gears, the flow regime is turbulent, (Re=10,000,000). To take into account the effects of turbulent flows inside, the Realizable k- ϵ turbulence model is used. This model is based on transport equation for turbulent kinetic energy and dissipation rate and has been

reported to have certain advantages in the modeling rotating and swirling flows. The transport equations of kinetic energy and dissipation rate can be presented as:

$$\begin{aligned} \frac{\partial}{\partial t}(\rho k) + \frac{\partial}{\partial x_j}[\rho u_j k - (\mu + \frac{\mu_t}{\sigma_k}) \frac{\partial k}{\partial x_j}] \\ = \mu(S_{ij} \frac{\partial u_i}{\partial x_j} - \frac{g_i}{\sigma_{h,t}} \frac{1}{\rho} \frac{\partial \rho}{\partial x_i}) - \rho \epsilon \\ - \frac{2}{3}(\mu_t \frac{\partial u_i}{\partial x_i} + \rho k) \frac{\partial u_i}{\partial x_i} \end{aligned} \quad (6)$$

$$\begin{aligned} \frac{\partial}{\partial t}(\rho \epsilon) + \frac{\partial}{\partial x_j}[\rho u_j \epsilon - (\mu + \frac{\mu_t}{\sigma_\epsilon}) \frac{\partial \epsilon}{\partial x_j}] \\ = C_{\epsilon 1} \frac{\epsilon}{k} [\mu_t P - \frac{2}{3}(\mu_t \frac{\partial u_i}{\partial x_i} + \rho k) \frac{\partial u_i}{\partial x_i}] \\ - C_{\epsilon 3} \frac{\epsilon}{k} \mu_t (\frac{g_i}{\sigma_{h,t}} \frac{1}{\rho} \frac{\partial \rho}{\partial x_i}) - C_{\epsilon 2} \rho \frac{\epsilon^2}{k} + C_{\epsilon 4} \rho \epsilon \frac{\partial u_i}{\partial x_i} \end{aligned} \quad (7)$$

where

$$C_{\mu} = 0.009, \sigma_k = 1.0, \sigma_\epsilon = 1.22, \sigma_h = 0.9, \sigma_m = 0.9, C_{\epsilon 1} = 1.44, \\ C_{\epsilon 2} = 1.92, C_{\epsilon 3} = 1.44, C_{\epsilon 4} = 0.419$$

Overset mesh, also known as Chimera, is used to discretize a computational domain with multiple different meshes that overlap each other in an arbitrary manner. Overset mesh does not need any mesh modification after generating the initial mesh. An overset mesh simulation needs background cells enclosing the entire solution domain and multiple smaller regions containing the bodies with in the domain. In overset mesh, cells are consist of active, inactive and acceptor types. At the active cells, discretized governing equations are solved. At the inactive cells, no equation is solved. The active cells and inactive cells change interactively by motion of bodies. In addition, acceptor cells separate active and inactive cells between background region and overset region and these cells are used to couple solutions between two overlapping grids. Solution values at donor cell at background region and overset region transferred to acceptor cell through interpolation. The donor cells are the active cells from other mesh that are nearest the acceptor cell. All the solution between donor cell and acceptor cell are calculated simultaneously. This means all the meshes are implicitly coupled.

2. GEOMETRY AND MESH RESOLUTION

Planetary gears are one sub-assembly part in the transaxles. Hence, prior to the simulations of the transaxle, a series of simulations for a planetary gear has been conducted in order to provide a technical CFD foundation for the transaxle. Planetary gear consists of a sun gear, planet gears and a ring gear. The dimensions of the simulated planetary gear are sun gear diameter D2=105 mm, planet gear diameter

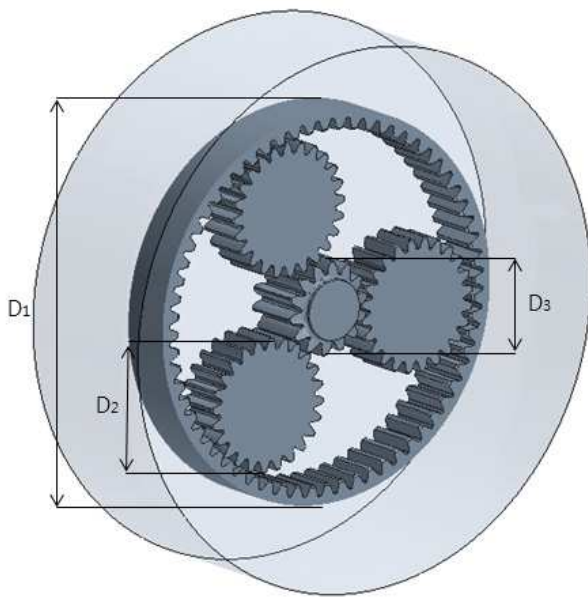

Figure 1. Geometry of planetary gear

$D_3=61$ mm and ring gear diameter $D_1=275$ mm. In the present model, number of ring gear teeth is 64 and number of sun gear teeth is 14. The operating condition of each gear is listed in Table 1

Table 1. Rotation rate of gears

Sun gear		758 rpm
Planet gear	Rotation	363 rpm
	Revolution	136 rpm
Planet gear cover		136 rpm
Ring gear		stationary

To make proper overset mesh, the smallest hexahedral cell size is chosen as 1mm. Therefore, two cells are located in narrowest gear gap. To make acceptor cells stable, cells have to be overlapped as many as possible. For sufficient number of mesh for gear gap, multiple prism layers are used at the wall surfaces of gears. The numerical simulations have been tested for different number of prism layers, and it has been found that at least 4 prism layers within the 2 mm thickness are required on each gear wall to avoid the numerical divergence. The CFD mesh domain contains four rotating and one stationary sub-domains. Finally, considering all necessary mesh parameters, the total number of hexahedral cells become approximately four million for the planetary gear simulations. A cut – section of the mesh resolution is shown in Fig. 3. In addition, the transaxle brake consists of brake pad, planetary gear system and oil reservoir. Brake pad is engaged with the sun gear of planetary gear system. Brake pad has four holes which are designed for oil exchange between reservoir and planetary gear room. The same geometry and mesh resolution with the planetary gear simulations has been chosen resulting in a total eight million hexahedral cells for this model

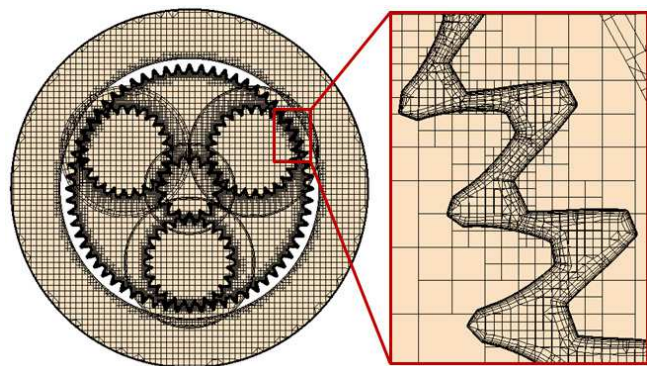

Figure 2. Mesh arrangement of planetary gear

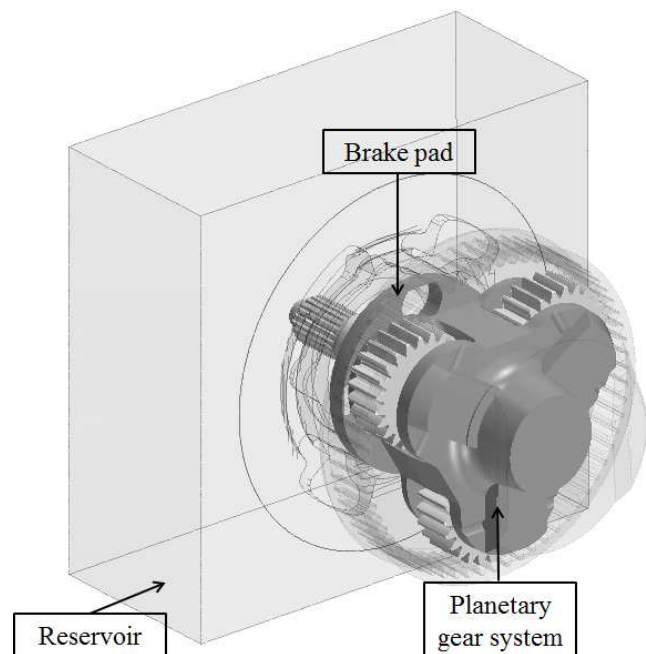
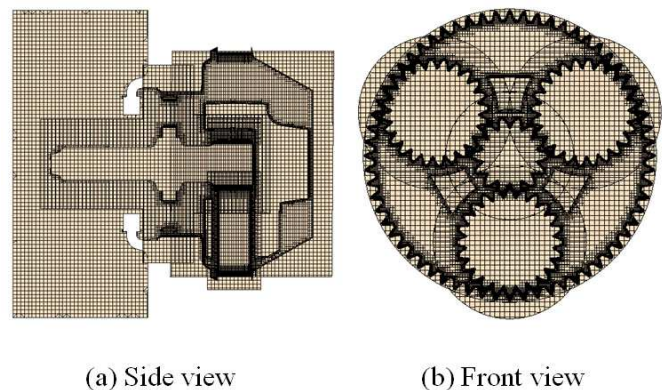

Figure 3. Geometry of transaxle brake



(a) Side view

(b) Front view

Figure 4. Mesh arrangement of transaxle brake

The CFD mesh domain is composed five rotational and one stationary sub-domains.

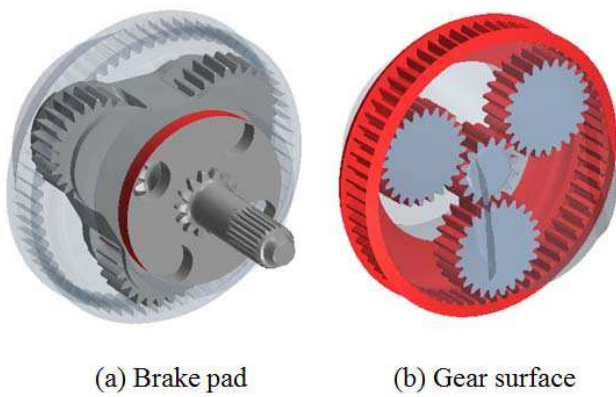

Figure 5. Brake heat generation region

3. RESULTS AND DISCUSSIONS

For the CFD simulations, the oil density, specific heat, conductivity and viscosity are assumed as 0.8461 Kg/m³, 0.4683 kcal/kg-K and 0.1141 kcal/m-hr-K and 46.35 cSt, respectively. To study the effects of initial oil level on the heat transfer coefficient, the planetary assembly with different initial oil levels 30%, 50% and 70% is investigated firstly. After this part, the transaxle is simulated with the oil level of 50%. The rotation rate of planetary gear system in transaxle brake is same with planetary gear simulation. This operating condition for the transaxle is defined to be very close to the highest speed condition of an industrial transaxle brake.

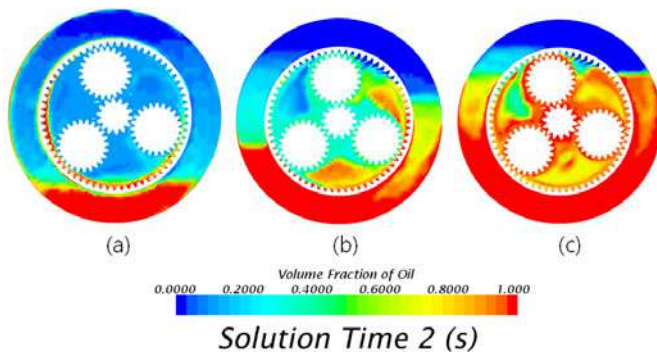

Figure 6. Steady state oil distribution in planetary gear according to initial oil level (30%, 50%, 70%)

3.1 Planetary gear simulation

The planetary gear simulations are continued until the steady state condition is achieved (the steady state condition judged by instantaneous volume fraction of oil distribution, the heat transfer coefficient of planetary gear surface and churning energy loss of oil in whole domain and is observed after approximate operational time of 2 sec.). The values of steady state volume of fraction distribution, velocity magnitude and also heat coefficient versus the initial oil level are shown in Figures 6-8, respectively. As it can be seen, for the cases with higher oil level, more oil is dispersed on the gears. In the Figure 6, volume fraction of oil distribution

according to initial oil level are shown. In case of 30%, oil does not considerably reach to the central and upper regions of planetary gear, and merely trivially scattered oil reaches to middle and upper

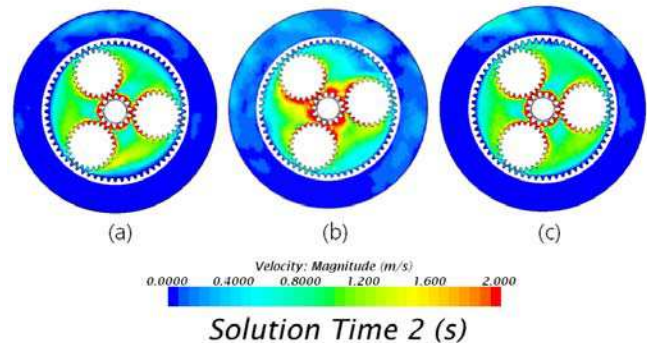

Figure 7. Steady state velocity distribution in planetary gear according to oil level (30%, 50%, 70%)

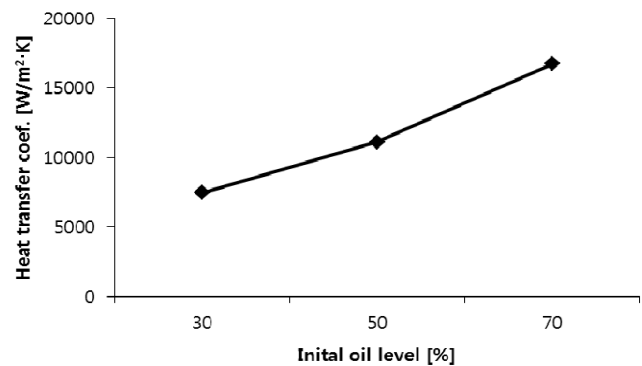

Figure 8. Predicted heat transfer coefficient according to oil level

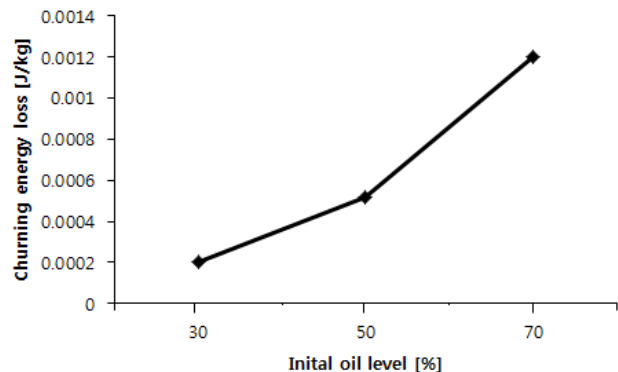

Figure 9. Predicted churning energy loss according to oil level

regions. In case of 50%, oil reaches higher, but still only relatively low amount of oil reaches to the upper region. However, when the initial level of oil is 70%, all regions are noticeably effected by lump of oil. In the Figure 7, velocity magnitude distribution after the operational time

of 2 second are shown. Near the sun gear teeth, velocity magnitude is highest because of the effects of sun gear rotation. In the Figure 8, average heat transfer coefficient of gear surface is shown according to initial oil level. In case of 30%,50% and 70 % the heat transfer coefficients are claculated as 7000 W/m²·K, 11000 W/m²·K and 17000 W/m²·K, respectively. These results show that initial oil level is a crucial factor for improving the cooling effects in a planetary gear assembly. Hence, to enhance the cooling effect, increasing the amount of oil can be considered. In the Figure 9, churning energy loss at steady state is shown according to initial oil level. In case of 30% churning energy loss is calculated about 0.0002 J/kg, about 0.0005 J/kg for 50% and about 0.0012 J/kg for 70% initial oil level. These results show that the higher oil level cause more energy loss of rotating gear. When initial oil level increases 30% to 70%, energy loss increases more then six times higher. This energy loss is related to the oil resistance against the rotation of the gears. A very similar trend has been reported by other scholars[1,5], in which the increasing the oil level causes increasing churning energy loss.

3.1 . Transaxle brake simulation

For the transaxle brake simulations, oil properties are same with the planetary gear system, the and initial oil level is assumed to be 50%. Rotation speed of the planetary gear of brake is same with previous planetary gear simulation. Brake pad is engaged with planet gear cover and it rotates at the same rotating speed. When brake is operating, the heat is generated on brake pad and gears surfaces. The heat generation during the

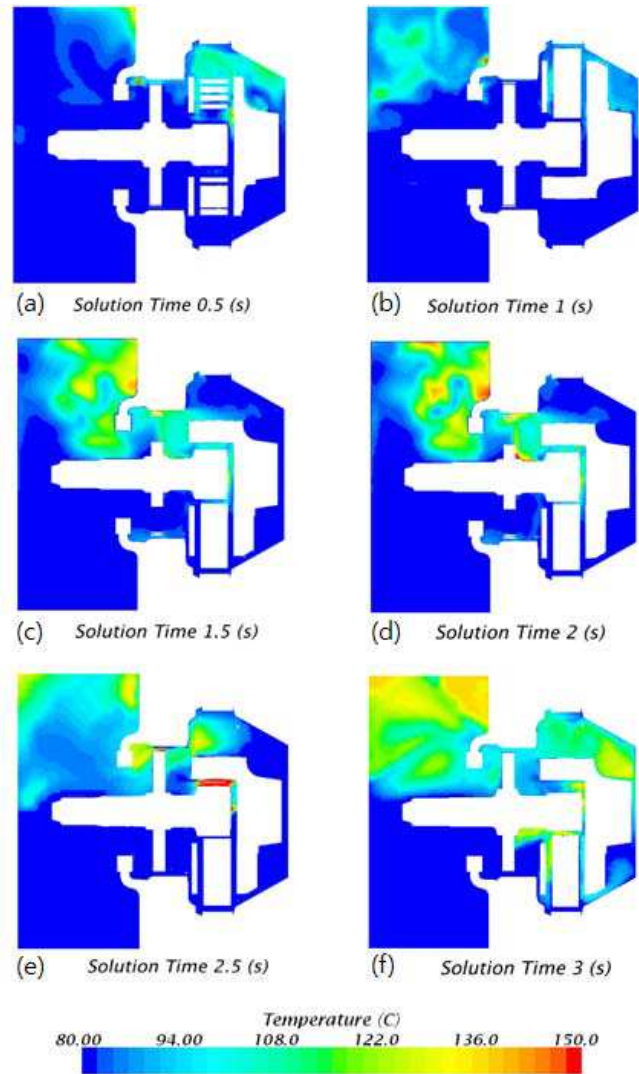

Figure 11. Temperature contour inside of brake

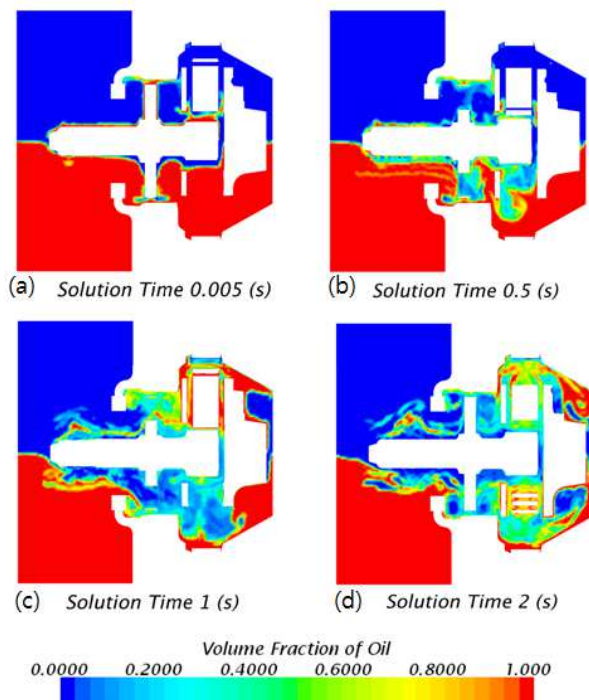

Figure 10. Volume fraction of oil inside of brake

operation is calculated and assumed to be 1500 W for brake pad and 600W for gear surface (these values are assumed to be close to the real case situation). As shown in Figure 3, there exists a cold oil reservoir at the left side and planetary gears at the right side of the brake pad. In addition, four holes are designed on the brake pad for oil transfer between the left and right sides for the sake of cooling. Also these holes are made to increase surface attached with oil and air for effective cooling whole brake pad. However, the problem of overheating still exists, which is caused by ineffective oil flow between the cold oil reservoir and the planetary chamber. This issue is related to the churning of the oil around the brake pad and oil despersion apart form the brake pad as a result of centrifugal forces. Similar to the previous part, the simulation is continued until the results of VOF distribution become steady state (after approximately 2 sec.). Hence, as it can be seen in Figure 10(d), when the flow reaches its steady state condion, the oil flow between the two sides is severely decreased. As shown, there exist only the air phase around the brake pad. So, there is no oil recirculation between cold reservoir region and planetary gear chamber. By heat generation of brake pad, left side of the brake is heated

first. At first, because of the rotation of planetary gear, heat of planetary gear dissipates well. However, as the rotation continues, the temperature inside the planetary chamber increases.

This problem is also addressed by Yanzhong Wang et al. [6] as "spin flow effect". They simulated one pair of rotating gears with stationary oil and oil jet and concluded that rotation of the gears decreases the quality of lubrication and oil circulation inside the chamber. Accordingly, in the present research the "spin flow effect" increases with the rotational speed of the brake pad. As a inevitable consequence of this "spin flow effect", heated oil remains in the the planetary chamber of the brake and the amount of heat transfer rate is very lower than the required amount of heat transfer for cooling planetary chamber of the brake. As time increases, this phenomenon causes the oil temperature rise inside the planetary chamber (as depicted in Figure 11).

To overcome this problem, several methods are suggested. According to planetary gear result, using more oil and filling the oil reservoir to a higher level is one solution to increase cooling effect. It is also helpful to devise a by-pass pipeline for oil exchange between the oil reservoir and planetary chamber, in order to compensate the spin flow effect.

4. CONCLUDING REMARKS

In the present research, the unsteady turbulent multiphase flow analysis of a planetary gear system and a transaxle brake are simulated in the presence of heat transfer using the overset mesh technique. Prior to run the transaxle simulation, the planetary gear is simulated using similar fluid properties at different initial levels of oil in order to achieve the appropriate resolution for the overset mesh technique and other CFD settings. The planetary gear simulations are carried out for oil levels of 30%,50% and 70%. The heat transfer coefficient versus oil level has been calculated. In addition, the oil churning energy loss versus oil level is plotted. Using the same mesh resolution, the transaxle brake simulation has been conducted with 50% oil level, and the phase distribution and heat characteristics inside the brake are obtained. Furthermore, the reason of overheating problem of transaxles is found to be the blockage of oil circulation inside the chamber between two sides of the brake pad (spin flow effect). This phenomenon is mainly caused by the brake pad fast rotation. According to the results, it is suggested to add a by-pass oil pipe to connect two oil chambers on both sides of the brake pad in order to compensate the spin flow effect.

REFERENCES

^[1] Tadashi Yamada, Measurement and prediction technology of cooling capability for hybrid drivetrain components, Automotive simulation world congress, 2014.

^[2] Miad Yazdani, Marios C. Soteriou, A novel approach for modeling the multiscale thermos-fluids of geared systems, International Journal of Heat and

Mass Transfer, 72:285-297, 2014.

^[3] N. Stosic, On heat transfer in screw compressors, International Journal of Heat and Mass Transfer, 72:517-530, 2015.

^[4] Nirvesh Mehta, Ravi K. Dayatar, Nilesh J. Parekh, CFD analysis of gearbox, International Journal of Engineering Research & Technology, Vo 2:Issue 3, 2013.

^[5] Li Li, Henk K versteeg, Graham K hargreve, Numerical investigation on fluid flow of gear lubrication, International Journal of Heat and Mass Transfer, 21:126-132, 2011.

^[6] Yanzhong Wang, Winstao Niu, Song Wei, Guanhua Song, Influence of spin flow on lubricating oil jet design method of oil spray parameters to high speed spur gears, Tribology International, 02:290-300, 2015.

^[7] Franco Conci, Corlo Gorla, A new methodology for the prediction of the no-load losses of gears : CFD and experimental investigation of the efficiency of a planetary gearbox, International Conference on Gears, Vol2, 2011.

^[8] Andrea Vacca, Marco Guidetti, Modeling and experimental validation of external spur gear machines for fluid power application, Simulation Modeling Practice and Theory, 19:2007-2031, 2011.

^[9] D. del Campo, R. Castilla, G. A. Raush, Numerical analysis of external gear pumps including cavitation, Journal of Fluids Engineering, Vol 134, 2012.

^[10] Jibin Hu, Wei Wu, Mingxing Wu, Shinhua Yuan, Numerical investigation of the air-oil twophase flow inside an oil-jet lubricated ball bearing, International Journal of Heat and Mass Transfer, 68:85-93, 2014.

^[11] Sujan Dhar, Andrea Vacca, A novel CFD-axial motion coupled model for the axial balance of lateral bushings in external gear machines, Simulation Modeling Practice and Theory, 26:60-76, 2012.

^[12] Bowang Xiao, Gang Wang, Qiqui Wang, An experimental study of heat transfer during forced air convection. Journal of Material Engineering and Performance, Vol20:1264-1270, 2010.

^[13] Mazdak Parsi, Ronald E. Vieira, Carlos F. Toress, Netaji R. Kesana, Brenton S. McLaurry, Siamack A. Shirazi, Eckhard Schleicher, Uwe Hampel, On the effect of liquid viscosity on interfacial structures within churn flow : Experimental study using wire mesh sensor, Chemical Engineering Science, Vol130 : 221-238, 2015.