



## Open Archive TOULOUSE Archive Ouverte (OATAO)

OATAO is an open access repository that collects the work of Toulouse researchers and makes it freely available over the web where possible.

This is an author-deposited version published in: <http://oatao.univ-toulouse.fr/>  
Eprints ID: 17651

**To cite this version:** Paroissien, Eric and Da Veiga, Anthony and Schwartz, Sébastien and Lélias, Guillaume and Lachaud, Frédéric and Meyer, Pierre-Yves *Simplified stress analysis of bonded joints using the macro-element technique*. (2015) In: Forum TERATEC 2015, 23 June 2015 - 24 June 2015 (Palaiseau, France). (Unpublished)

Official URL: [http://www.teratec.eu/gb/forum\\_2015/atelier\\_4\\_06.html](http://www.teratec.eu/gb/forum_2015/atelier_4_06.html)

Any correspondence concerning this service should be sent to the repository administrator: [staff-oatao@listes-diff.inp-toulouse.fr](mailto:staff-oatao@listes-diff.inp-toulouse.fr)



# Simplified stress analysis of bonded joints using the macro-element technique

Presented by:	E. PAROISSIEN	SOGETI HIGH TECH, Toulouse (FR)
Co-Authors:	A. DA VEIGA	SOGETI HIGH TECH, Toulouse (FR)
	S. SCHWARTZ	SOGETI HIGH TECH, Toulouse (FR)
	G. LELIAS	SOGETI HIGH TECH, Toulouse (FR)
	F. LACHAUD	ISAE-SUPAERO, Toulouse (FR)
	P-Y. MEYER	SOGETI HIGH TECH, Toulouse (FR)

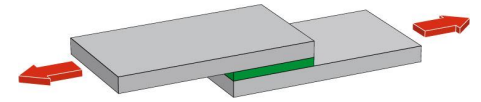

- 1. SOGETI HIGH TECH**
- 2. FRAME**
- 3. MECHANICAL ANALYSIS**
- 4. MACRO-ELEMENT TECHNIQUE**
- 5. CURRENT CAPABILITIES**
- 6. RELEVANCE**
- 7. APPLICATION**

# Content

A thick red line that starts with a decorative flourish on the left and extends horizontally across the top of the page.

## SOGETI HIGH TECH

# A Capgemini group subsidiary

In 44 countries

Revenue of 10.1 billion euros

131.000 people with more than 50,000 pin offshore\*

Capgemini, founded in 1967, is one of the world foremost providers of consulting, technology and outsourcing services.

## Revenue by industry

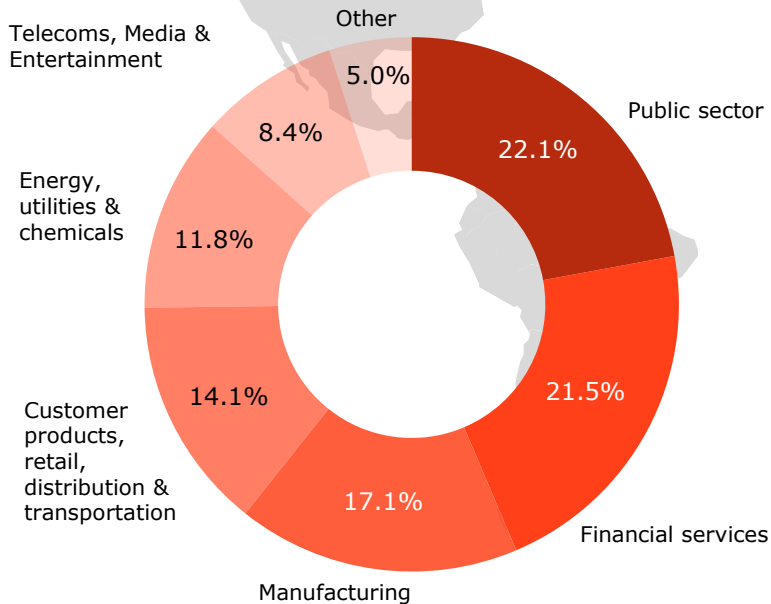

## Revenue by business

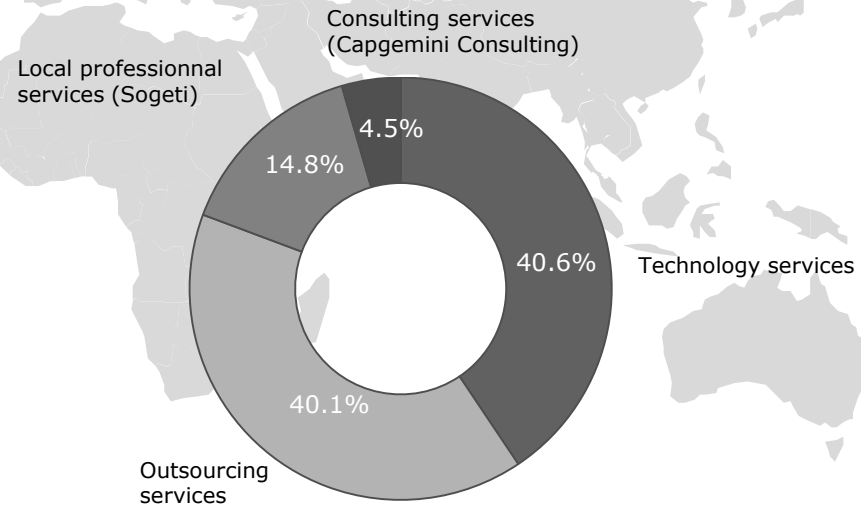

Capgemini Consulting

Capgemini  
CONSULTING. TECHNOLOGY. OUTSOURCING

SOGETI

Prosodie

EURIWARE

\*offshore = Inde, Vietnam, Maroc, Guatemala, Pologne,...

# Sogeti : Engineering and Technology Consulting Services in the world

Nearly **20.000** employees on **100** locations in **15** countries



▲ Sogeti High Tech business development

# Sogeti High Tech, specialist in Engineering and R&D

## • Leader in Engineering and Technology Consulting Services

- A 25-year long expertise in services for industrial companies
- Seven main markets :
  - Aeronautics
  - Energy
  - Life Sciences
  - Railway
  - Space
  - Defense
  - Telecoms & media

## • Five business lines

- Consulting
- Systems Engineering
- Physics Engineering
- Software Engineering
- Testing

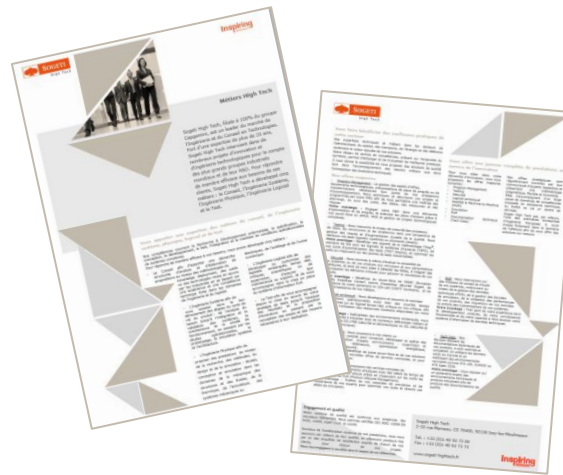
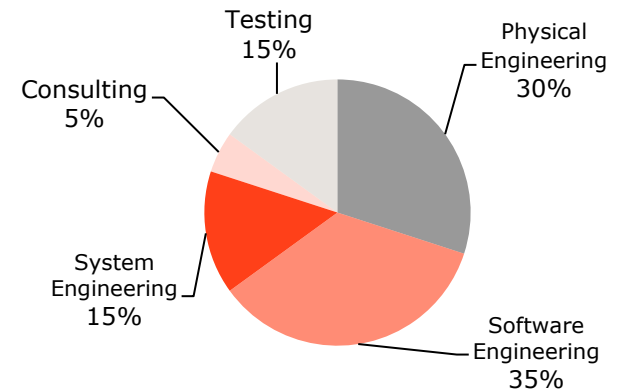

# Sogeti High Tech's locations

- 3000 employees in France
- 300 employees in Germany
- 19 locations
- Rank n°1 in the Aeronautics & Space sectors
- 5th rank in the French market





# Content

A thick red line that starts with a decorative flourish on the left and extends horizontally across the top of the page.

**FRAME**

### JoSAT (Joint Stress Analysis Tool)

#### ✓ ID SHEET:

- internal research project
- started in 2008
- self-funding
- workload: 7400 days at the end of June 2015

#### ✓ DRIVEN LINE

- *research theme*: joining technologies
- *2 research axes*: axis **bonding** and axis **bolting**
- *objectives*: **better understanding of the mechanical behavior** of bonded joints and bolted joints
  1. to develop a **simplified mechanical analysis tool**
  2. to **better control** these joining technologies

### Partnerships

#### ✓ ISAE (Institut Supérieur de l'Aéronautique et de l'Espace, Toulouse):

- signed in 2009
- prolonged in 2012 up to 2017



THEMES	WHAT?
COMPOSITE MATERIALS	2 PhD Theses 1 MS Thesis
JOINING TECHNOLOGIES	1 PhD Thesis 6 MS Theses



#### ✓ BORDEAUX INP / ENSEIRB-MATMECA

- our Center of Competences is trusted to teach their students

the Mechanics of Assemblies (<https://www.enseirb-matmeca.fr/syllabus1415/index.php?&module=MS312&langage=EN>)

#### ✓ AN ADHESIVE SUPPLIER

- to be signed but collaborative activities already in progress

## Rationale of Development

Stress can support M&P, Manufacturing and Operations

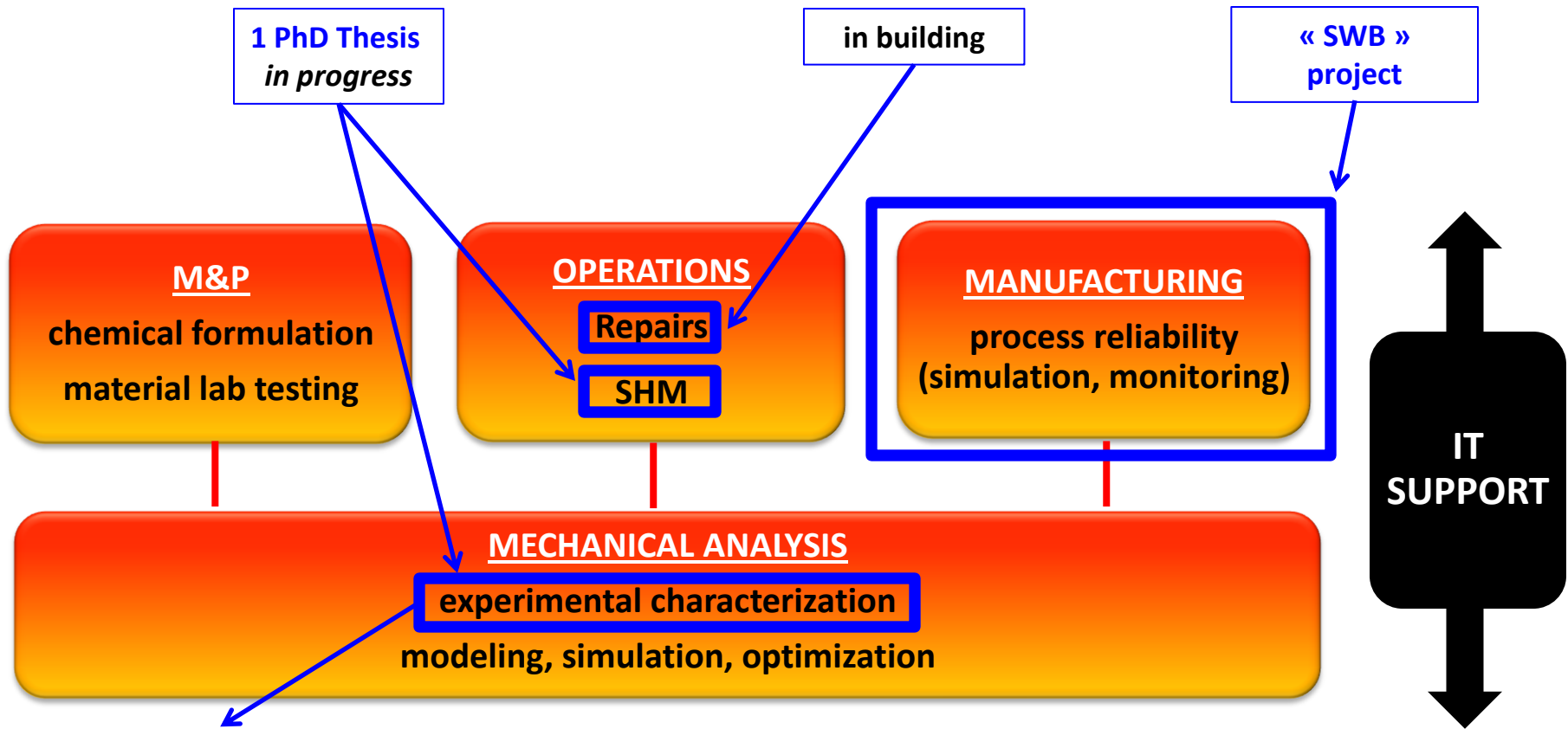

Presentation on the 3<sup>rd</sup> July 2015 at Adhesive Bonding Conference in Porto

## MECHANICAL ANALYSIS

### Strength Prediction

- ✓ Strength prediction consists in **comparing computed criteria with allowable**.
- ✓ The definition of criteria can be based on:
  - experimental and theoretical investigations on the failure mechanisms
  - in-service feedbacks
- ✓ Criteria requires input data , provided by **mechanical analysis**.
- ✓ Allowable are obtained from experimental characterization.

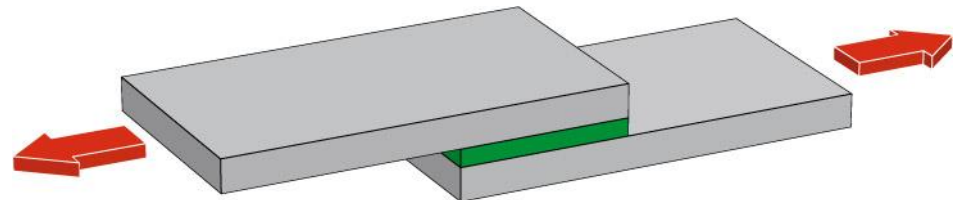

# Mechanical Analysis

*How?*

## Finite Element (FE) Analysis

- ✓ FE method can address the mechanical analysis of bonded joints, to provide input data to criteria.
- ✓ Nevertheless, FE analysis:
  - is **time consuming**
  - and demands **highly skilled engineers** to be suitably applied
- ✓ The relative difference in thickness between the adhesive and the adherends, and the mesh requirements conducts to develop models with **a very high number of degrees of freedom**

### Example of single-lap bonded joint in 3D:

- **adherend thickness: 2 mm / adhesive thickness: 0.2 mm**
  - **10 cubic elements in adhesive thickness = 0.02 mm each**
  - **transition ratio of 1 imposed at the adhesive interface, an element size of 0.02 mm**
- ⇒ **potentially 100 elements in the adherend thickness, to be multiplied by length, width mesh parameters**

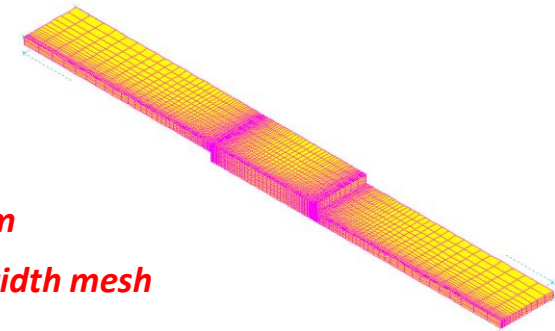

### A Mathematical Issue

- ✓ Various analytical closed-form solutions exist, based on simplifying hypotheses on the kinematics and the number of adhesive stress tendon components to be considered, leading to accurate mechanical behavior approximation.
- ✓ But **the application field appears as restricted**, even for practical problems (ex: steel to aluminium joint including bending and normal displacement)
- ✓ To enlarge the application field, **mathematical procedures** shall be used to solve the set of governing differential equations (deduced from hypotheses taken)

**The macro-element technique is a mathematical procedure**



## MACRO-ELEMENT TECHNIQUE

# Macro-Element Technique

Origin

## Simplified Analysis of Hybrid Joints

- ✓ First developments between 2004 and 2006 in the frame of [PAROISSIEN's PhD \[1\]](#), to simplify the stress analysis of **hybrid (bolted/bonded) joints**
- ✓ **Significant extension of the application field** since 2008 by SOGETI HIGH TECH in the frame of JoSAT

Idea from:  
Prof. Marc SARTOR  
INSA Toulouse

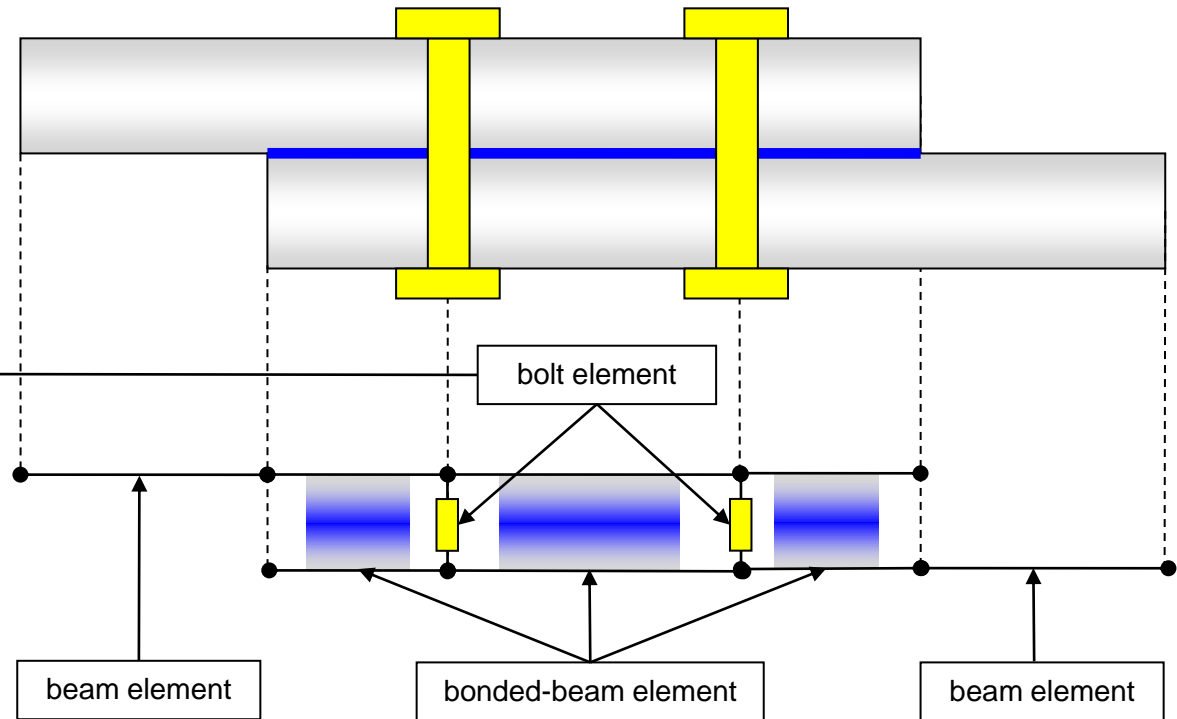
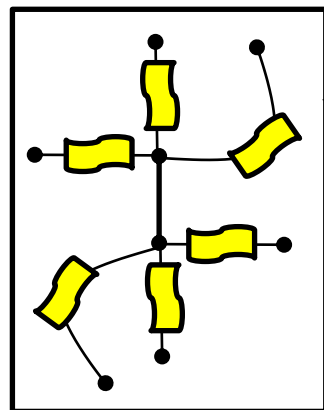

# Macro-Element Technique

## Chronology

From 2004 up to now

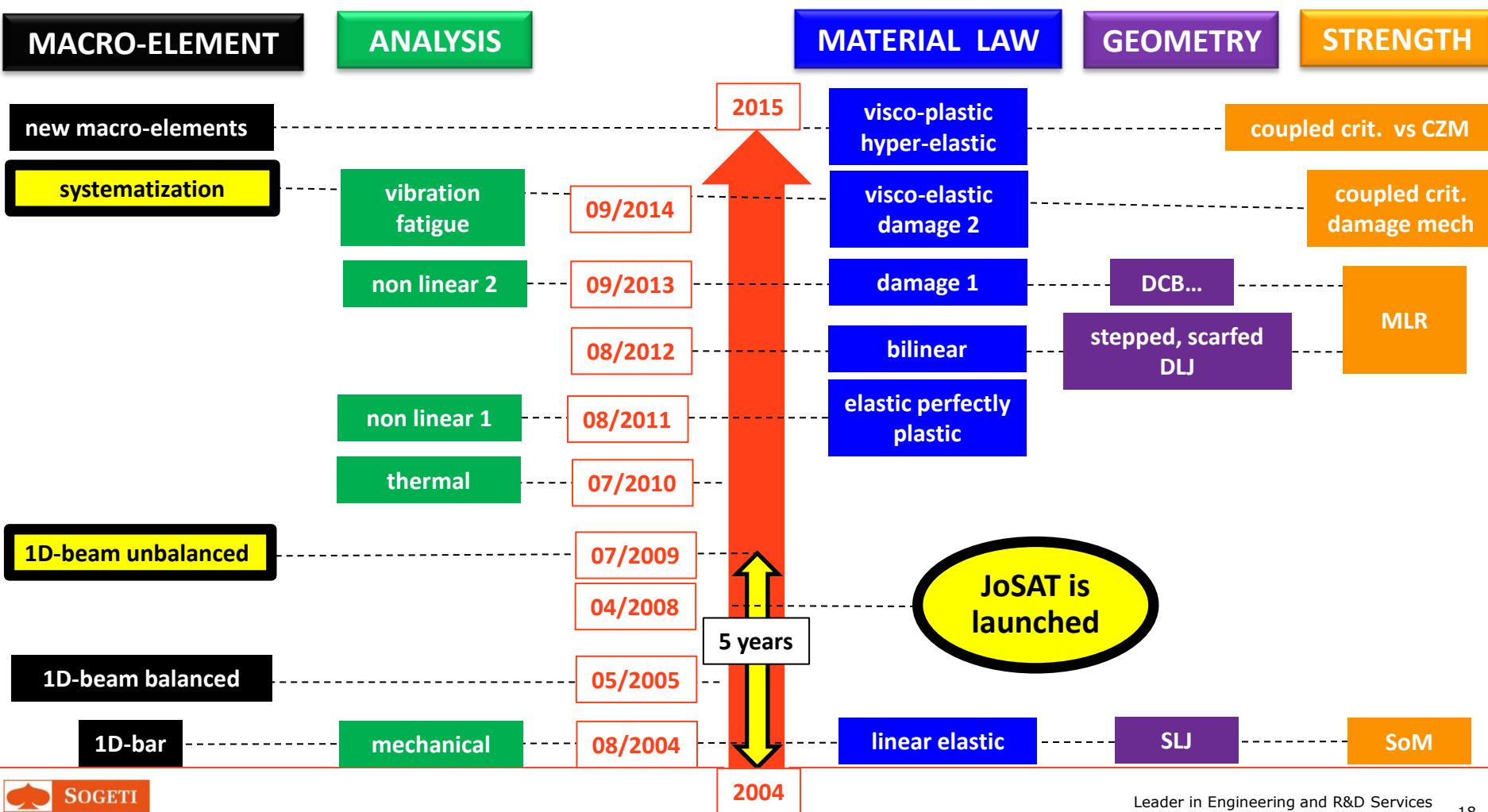

# Macro-Element Technique

How?

## Inspired by FE Method

- ✓ **1<sup>st</sup> STEP: MESHING THE JOINT**, in beam (or bar) elements and macro-element.
  - **Only 1 macro-element** is needed **for 1 entire overlap**
- ✓ **2<sup>nd</sup> STEP: ASSEMBLY OF THE STIFFNESS MATRIX ( $K$ )** for the joint
  - **KEY POINT:** the stiffness matrix of the macro-element (see next slide)
- ✓ **3<sup>rd</sup> STEP: APPLICATION OF BOUNDARY CONDITIONS** (load and prescribed displacement)
- ✓ **4<sup>th</sup> STEP: MINIMIZATION OF POTENTIAL ENERGY**
  - leading to a linear system to be solved:  $F=KU$

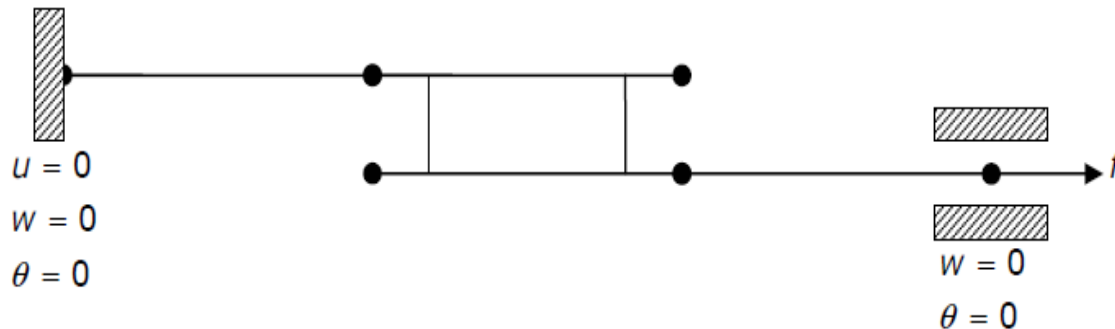

### Example:

*single-lap bonded joint in-plane loaded membrane + bending*

=> the solution consists in inverting a **13x13 linear system only!**

# Macro-Element Technique

## Stiffness Matrix (Bonding)

### Principle

✓ (semi-)analytical formulation based on the set of governing differential equations:

- local equilibrium equations
- constitutive equations

There is **not any hypotheses on the shape of interpolation functions.**

The shape of interpolation functions is the shape of solutions of the system of governing differential equations

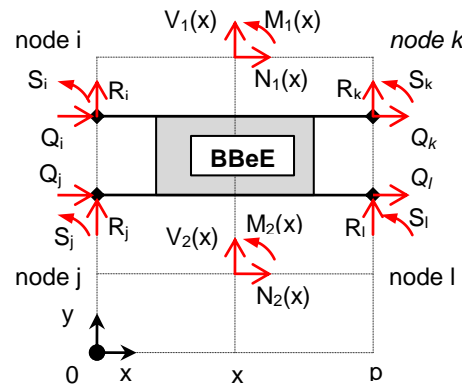
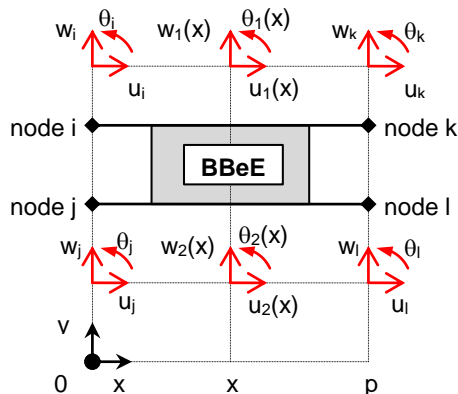

$$K_{BBe} = \begin{pmatrix} \left[ \frac{\partial Q_\sigma}{\partial u_\tau} \right] & \left[ \frac{\partial Q_\sigma}{\partial w_\tau} \right] & \left[ \frac{\partial Q_\sigma}{\partial \theta_\tau} \right] \\ \left[ \frac{\partial R_\sigma}{\partial u_\tau} \right] & \left[ \frac{\partial R_\sigma}{\partial w_\tau} \right] & \left[ \frac{\partial R_\sigma}{\partial \theta_\tau} \right] \\ \left[ \frac{\partial S_\sigma}{\partial u_\tau} \right] & \left[ \frac{\partial S_\sigma}{\partial w_\tau} \right] & \left[ \frac{\partial S_\sigma}{\partial \theta_\tau} \right] \end{pmatrix}, \sigma, \tau = i, j, k, l$$

# Macro-Element Technique

## 1D-Bar Stiffness Matrix (Bonding)

### Hypotheses

✓ linear local equilibrium :

- VOLKERSEN [2]

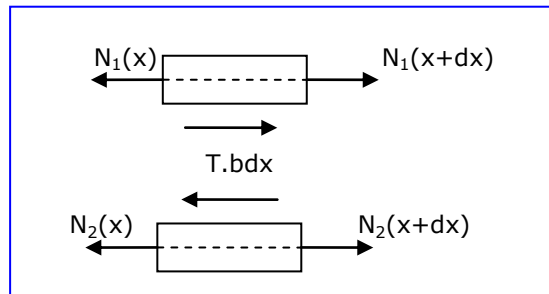

✓ adherend as linear bars:

- including thermal expansion
- linear variation of the adherend shear stress with the thickness as TSAÏ, OPLINGER and MORTON [3]

✓ adhesive layer as shear springs continuously distributed:

- adhesive thickness constant along the overlap
- adhesive shear stress and shear stress supposed constant in the adhesive thickness

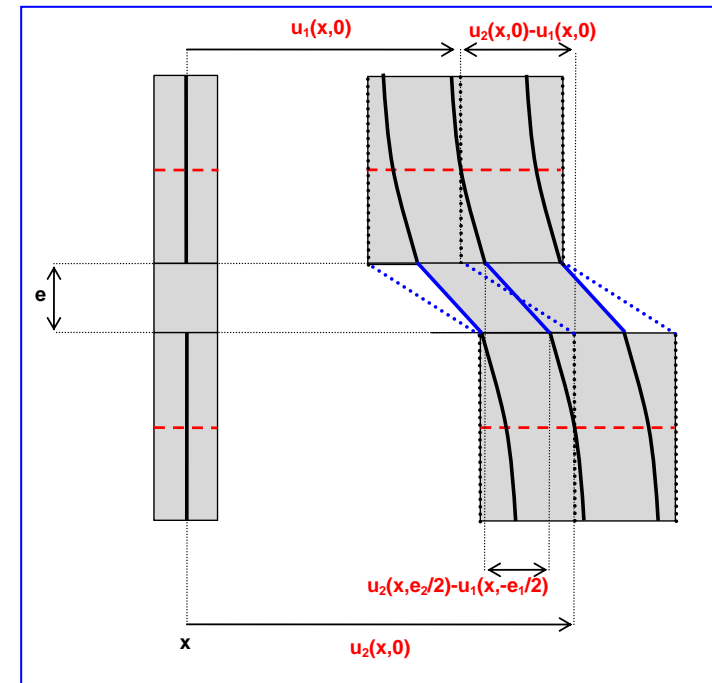

# Macro-Element Technique

## 1D-Beam Stiffness Matrix (Bonding)

### Hypotheses

✓ linear local equilibrium available:

- GOLAND & REISSNER [4]
- HART-SMITH [5]

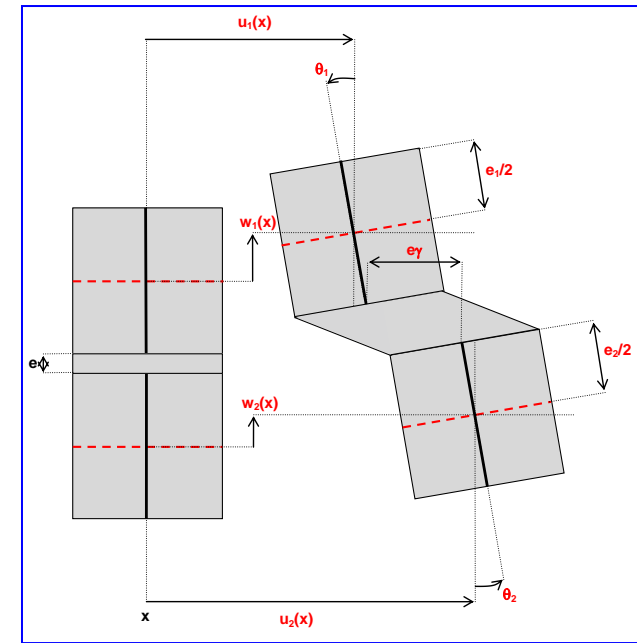
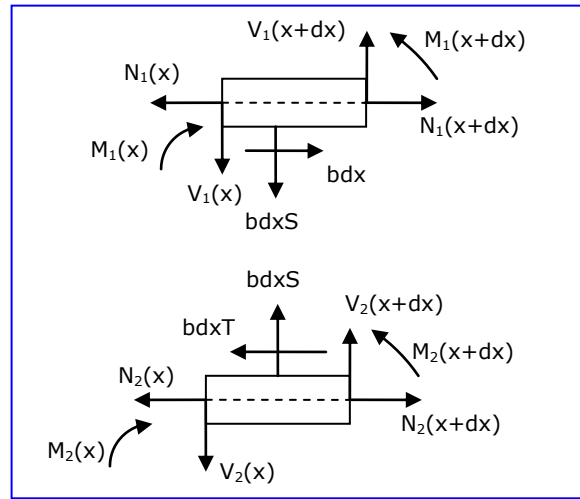

✓ adherend as linear Euler-Bernoulli beam:

- in the classical laminated theory
- including thermal expansion
- linear variation of the adherend shear stress with the thickness as TSAÏ, OPLINGER and MORTON [3]

✓ adhesive layer as shear and peel springs continuously distributed:

- adhesive thickness constant along the overlap
- adhesive shear stress and shear stress supposed constant in the adhesive thickness

# Macro-Element Technique

## 1D-Beam Stiffness Matrix (Bonding)

### Equations (1)

#### local equilibrium (GOLAND & REISSNER)

$$\begin{cases} \frac{dN_j}{bdx} = (-1)^j T \\ \frac{dV_j}{bdx} = (-1)^{j+1} S \\ \frac{dM_j}{dx} + V_j + \frac{1}{2}(e_j + e) b T = 0 \end{cases}, \quad j = 1, 2$$

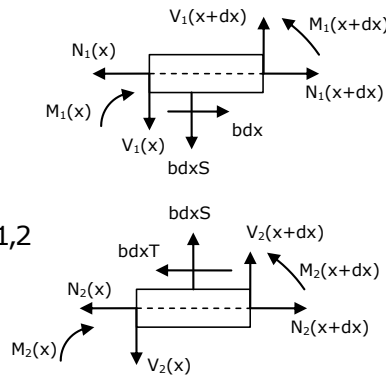

#### constitutive equations shear springs, peel springs

$$\begin{cases} T = \frac{G}{e} \left( u_2 - u_1 - \frac{1}{2} e_1 \theta_1 - \frac{1}{2} e_2 \theta_2 \right) \\ S = \frac{E}{e} (w_1 - w_2) \end{cases}$$

#### constitutive equations Euler-Bernoulli laminated beam

$$\begin{cases} N_j = A_j \frac{du_j}{dx} - B_j \frac{d^2 w_j}{dx^2} \\ M_j = -B_j \frac{du_j}{dx} + D_j \frac{d^2 w_j}{dx^2}, \quad j = 1, 2 \\ \theta_j = \frac{dw_j}{dx} \end{cases}$$

SYSTEM OF COUPLED DIFFERENTIAL EQUATIONS

resolution

Expression for displacements then for internal forces

HARD WORK



# Macro-Element Technique

## 1D-Beam Stiffness Matrix (Bonding)

### Equations (2)

*Computation of nodal forces and nodal displacements*

$$\mathbf{U} = \begin{pmatrix} u_i \\ u_j \\ u_k \\ u_l \\ w_i \\ w_j \\ w_k \\ w_l \\ \theta_i \\ \theta_j \\ \theta_k \\ \theta_l \end{pmatrix} = \begin{pmatrix} u_1(0) \\ u_2(0) \\ u_1(\Delta) \\ u_2(\Delta) \\ w_1(0) \\ w_2(0) \\ w_1(\Delta) \\ w_2(\Delta) \\ \theta_1(0) \\ \theta_2(0) \\ \theta_1(\Delta) \\ \theta_2(\Delta) \end{pmatrix} = \mathbf{MC} \quad \text{and} \quad \mathbf{F} = \begin{pmatrix} Q_i \\ Q_j \\ Q_k \\ Q_l \\ R_i \\ R_j \\ R_k \\ R_l \\ S_i \\ S_j \\ S_k \\ S_l \end{pmatrix} = \begin{pmatrix} -N_1(0) \\ -N_2(0) \\ N_1(\Delta) \\ N_2(\Delta) \\ -V_1(0) \\ -V_2(0) \\ V_1(\Delta) \\ V_2(\Delta) \\ -M_1(0) \\ -M_2(0) \\ M_1(\Delta) \\ M_2(\Delta) \end{pmatrix} = \mathbf{NC}$$

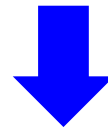

*Stiffness Matrix*

$$\mathbf{K} = \mathbf{NM}^{-1}$$

## CURRENT CAPABILITIES

# Current Capabilities

*Input*

## Geometry

✓ AS A “LEGO GAME”, various geometrical configurations can be modeled:

- squared-end single-lap as the nominal configuration
- tapered-end single-lap configuration
- double-lap configuration
- fracture mechanics coupons (ENF, DCB, MMB)
- patch or stiffened configuration **[POSSIBLE]**
- etc.... + including fasteners

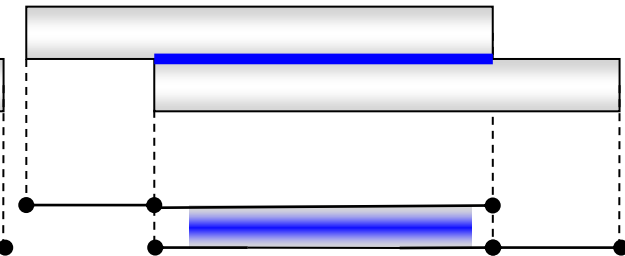
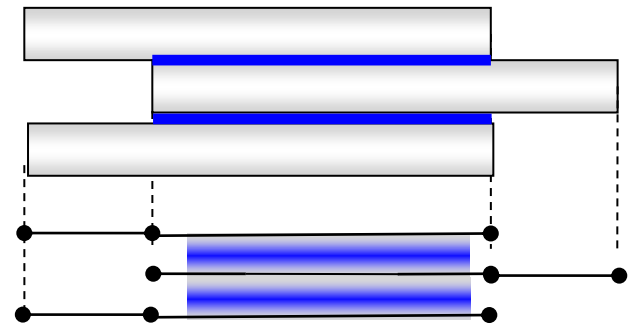
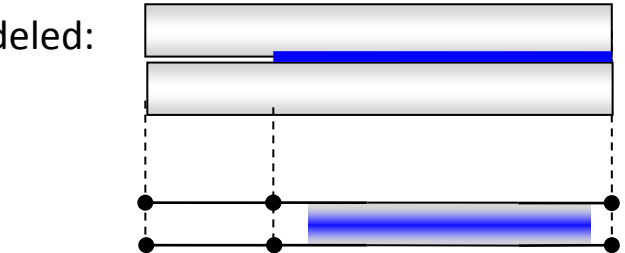
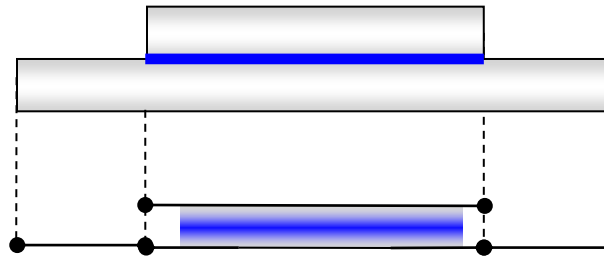
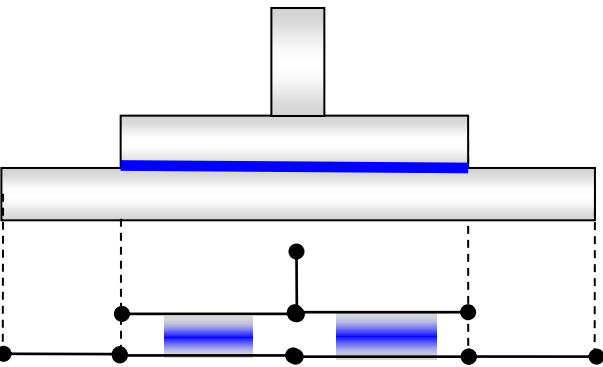

# Current Capabilities

Input

## Adhesive Material

✓ VARIOUS ADHESIVE MATERIAL CAN BE SUPPORTED:

- linear elastic
- elastic perfectly plastic [6, 8]
- bilinear (isotropic, kinematic, mixed hardening) [6, 8]
- damage evolution law with various shapes and mixed mode [9]
- visco-elastic including time-temperature dependency

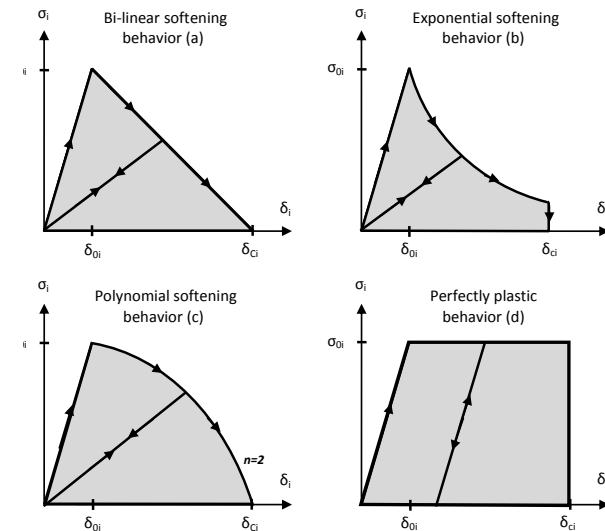
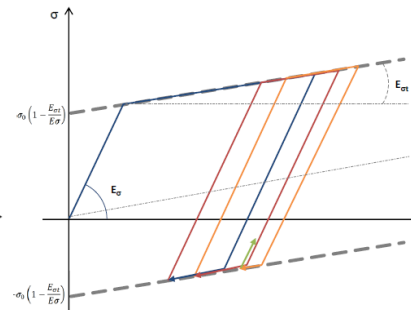
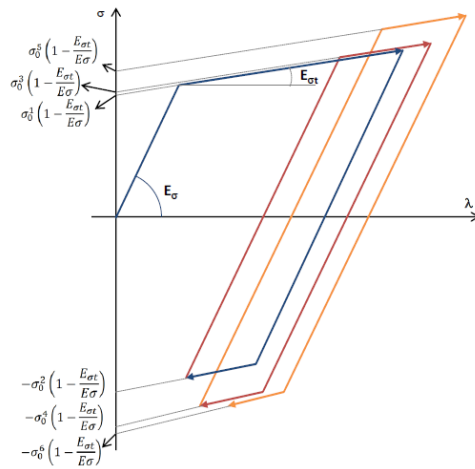
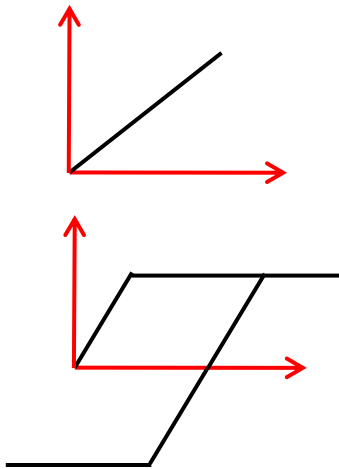
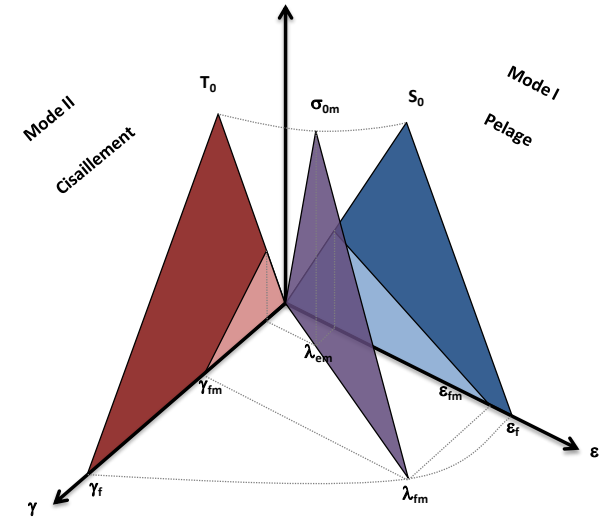

### Adherend Material

#### ✓ EULER-BERNOULLI BEAM

- in the frame of the classical laminated theory
- balanced and unbalanced cases
- linear elastic

#### ✓ LINEAR ELASTIC BEHAVIOR IS NOT A RESTRICTION

- the non-linear algorithm already developed to support non-linear adhesive material
- non linear adherend material could be then implemented

# Current Capabilities

*Input*

## Loading

- ✓ **STATIC [6-9]**
  - loading in force or in displacement
- ✓ **HYDRO-THERMAL**
  - uniform variation of temperatures [7] and/or of moisture rate
- ✓ **FATIGUE**
  - basing on progressive damage approach [10, 11] [algo ok, approach under assessment]
- ✓ **VIBRATION**
  - mass matrix implemented
  - free modes assessment

### Results Directly Available

#### ✓ DISTRIBUTION AT ANY POINTS:

- displacements in the adherends ( $u, v, \theta$ )
- internal forces in the adherends (normal force, shear force, bending moment)
- forces in the fasteners (bolt transfer rate)
- shear stress and peel stress along the overlap
- **[EASILY FAISABLE]** stress and strain in the adherends can be easily computed from internal forces

**The tool provides input for the computation of strength criteria**

# Content

---

**RELEVANCE**



# Relevance

## Validation

### Against Available Literature [6]

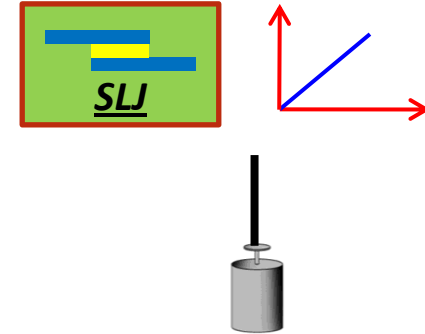

✓ GOLAND & REISSNER [4] stress analysis improved by TSAI et al. [3]

- linear elastic adhesive
- 1D-beam kinematics, simply supported, in-plane mechanically loaded

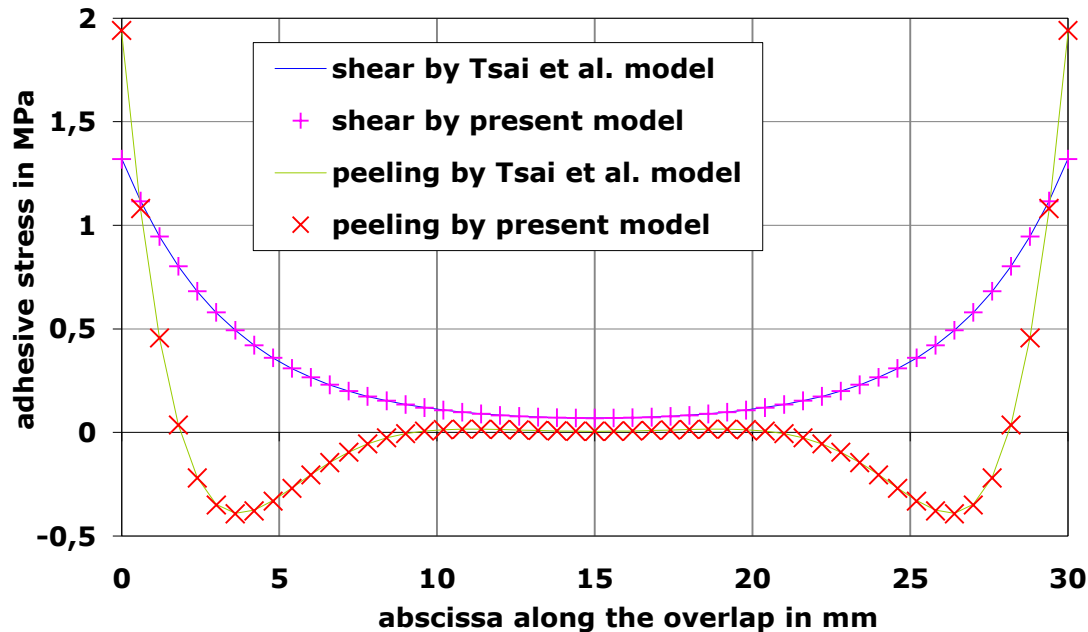

# Relevance

## Validation

### Against Degraded FE Model [6]

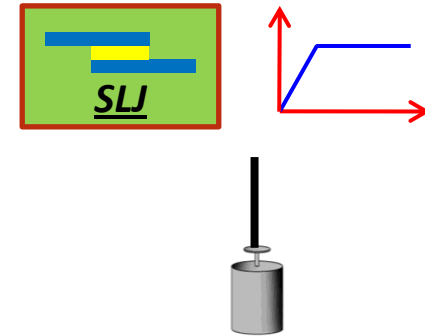

✓ Degraded FE model, composed by bars and springs

- elastic perfectly plastic adhesive, after maximal stress yield criterion
- 1D-bar kinematics, in-plane mechanically loaded

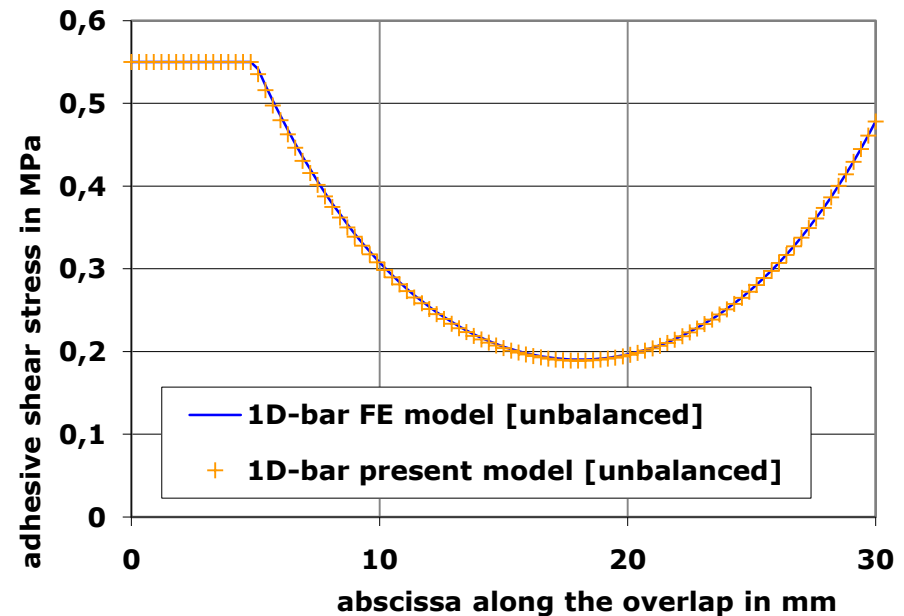
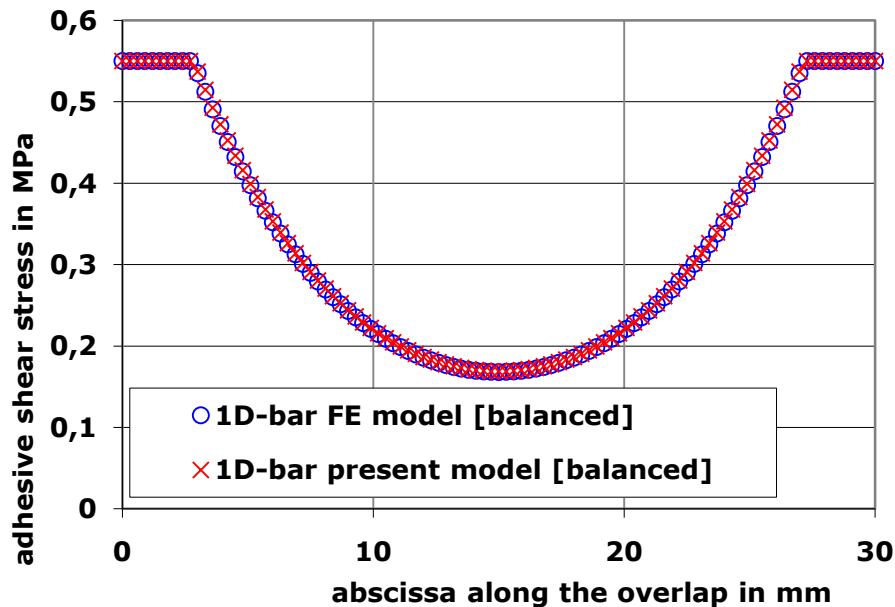

# Relevance

## Assessment

### Against Refined FE Model [6,8]

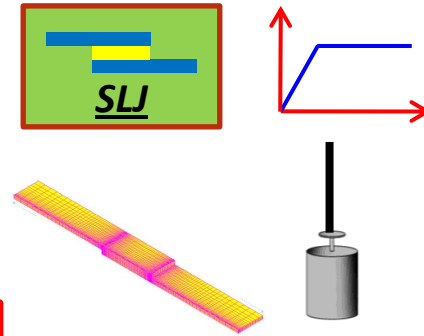

#### ✓ Against refined 3D FE models

- elastic perfectly plastic adhesive after Von Mises yield criterion
- 1D-beam kinematics, unbalanced, in-plane mechanically loaded

**CPU TIME SAVINGS: 50 times faster than FE model**

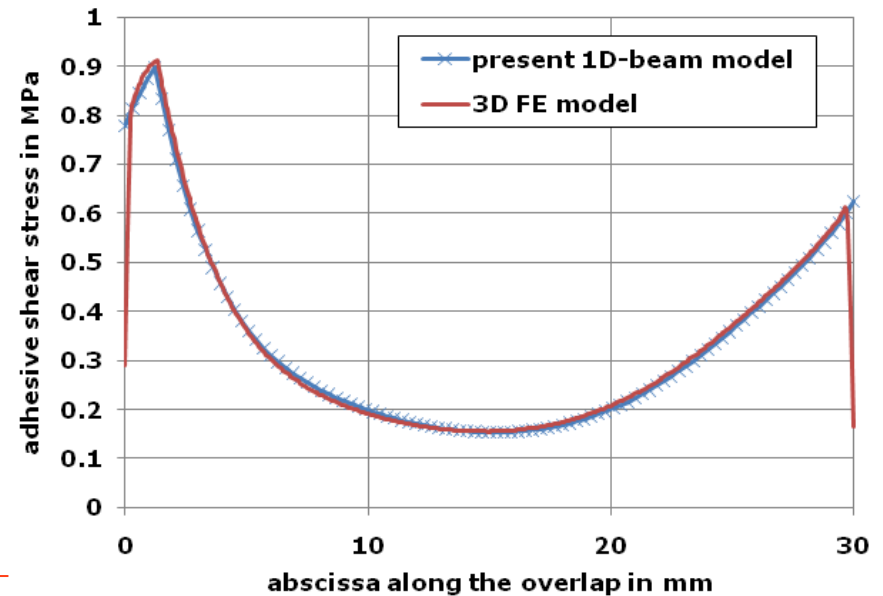
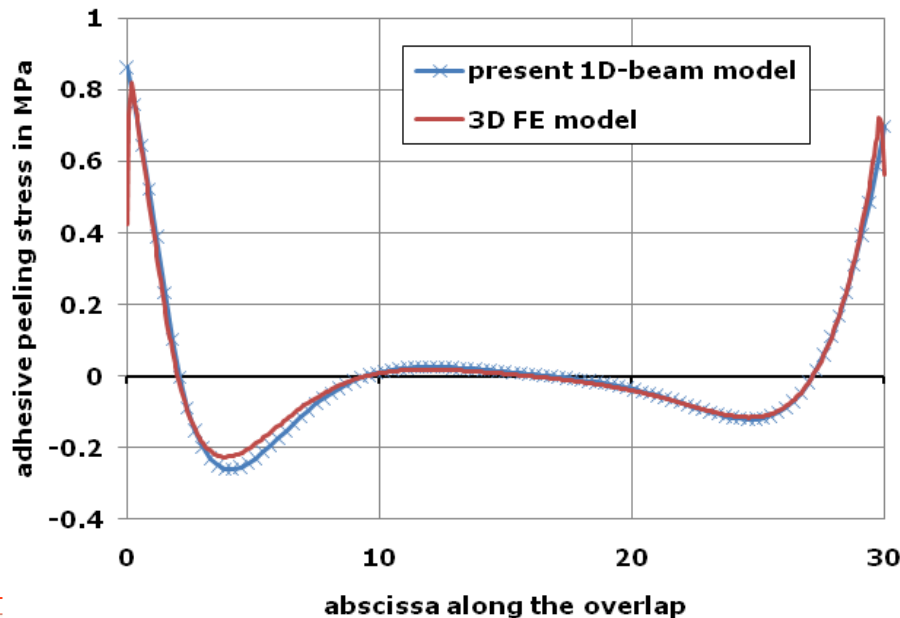

### With SCILAB Code

✓ **Clamped single-lap bonded joint:**

- bilinear elasto-plastic
- kinematic, isotropic and mixed hardening
- mechanically loaded
- loading then unloading

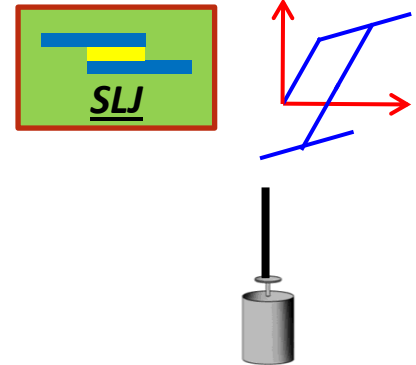

# Relevance

## Demonstration

### Early IHM

✓ Clamped single-lap bonded joint in-plane loaded:

- bilinear damage evolution
- mixed mode I/II
- loading then unloading

**DEMO**

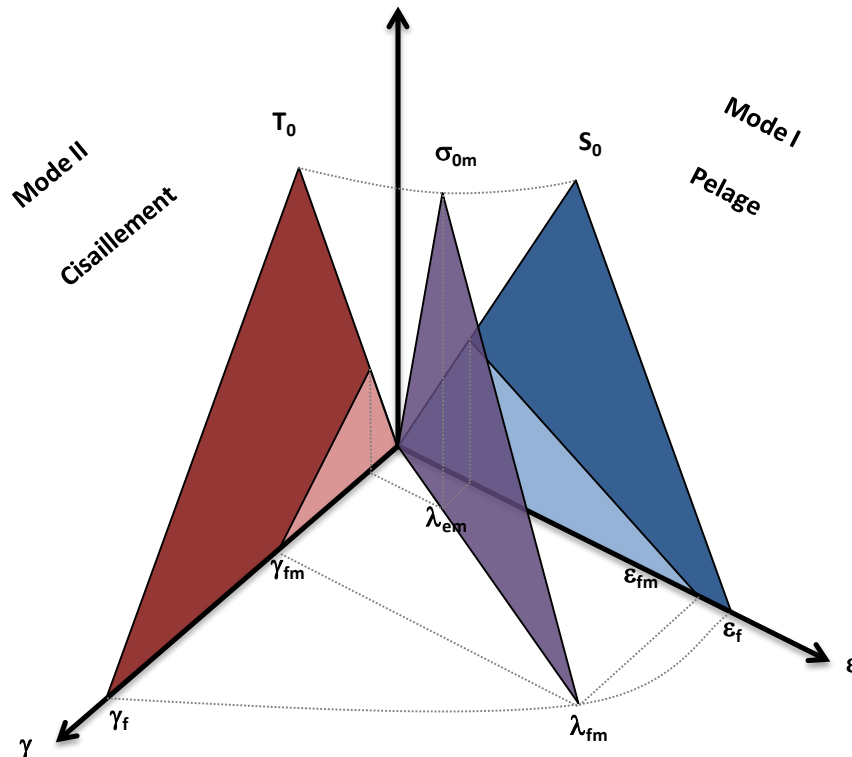
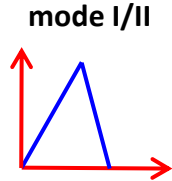
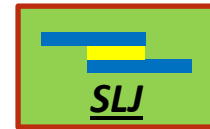

# Relevance

## Demonstration

### Against Refined FE models

#### ✓ Against refined 3D FE models

- bilinear adhesive damaging evolution law
- 1D-beam kinematics, unbalanced, in-plane mechanically loaded

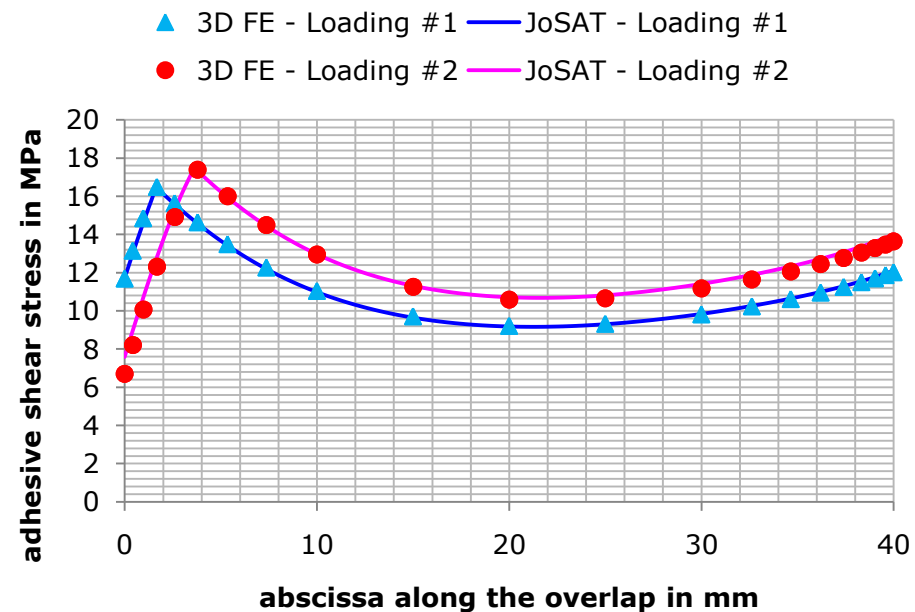
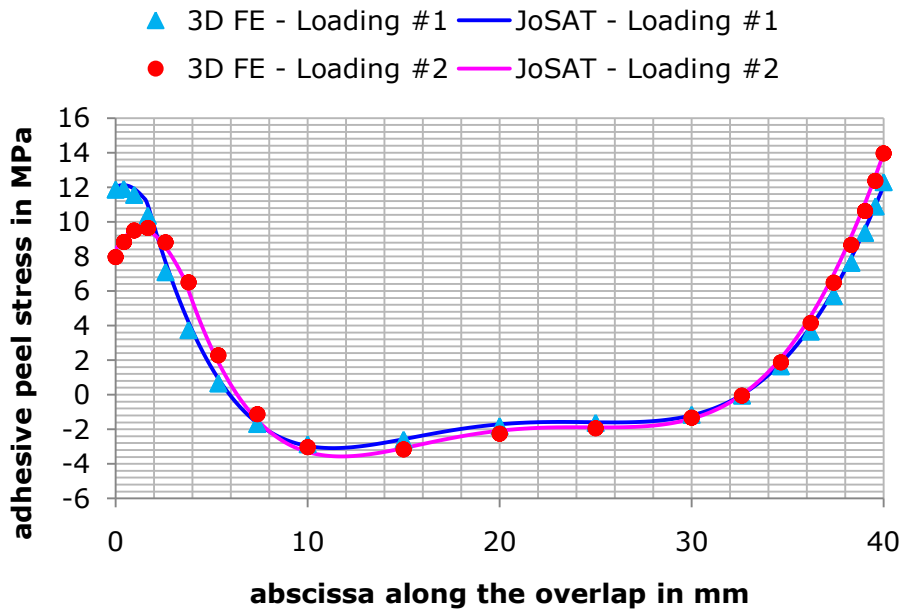
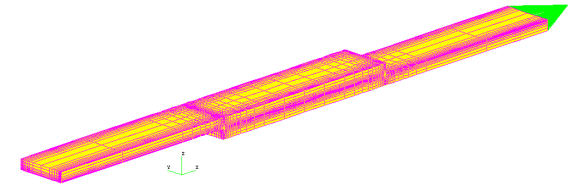

**VERY GOOD AGREEMENT WITH 3D FE PREDICTIONS**

# Content

A thick red line that starts on the left, dips down into a small curve, then runs horizontally across the top of the page, and finally curves up on the right side.

## APPLICATION

## Experimental Test

### Hybrid (Bolted / Bonded) Joints

#### ✓ Identification of material parameters [IN PROGRESS]

- through an optimization platform
- to analyze failure mechanisms

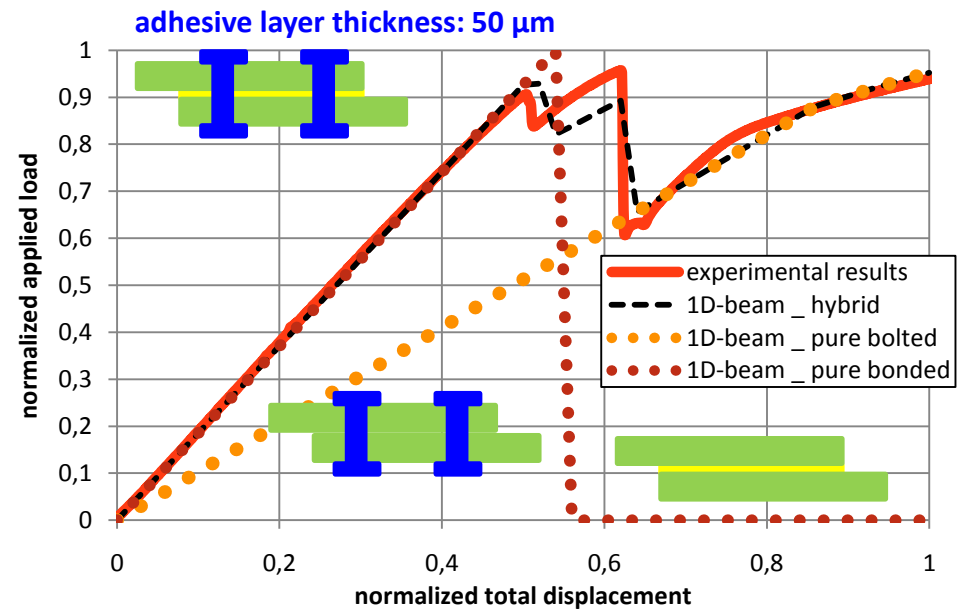
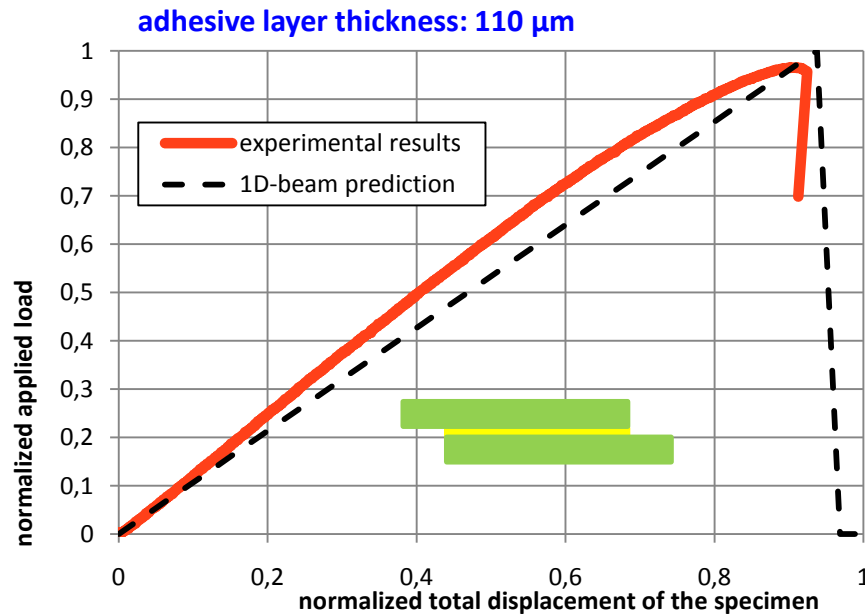
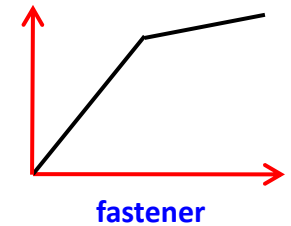
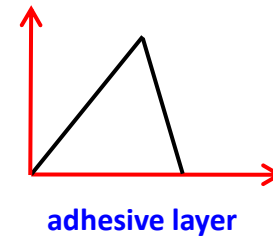



## Process Reliability

✓ Simulation of the reliability of the manufacturing process

- Considering manufacturing knowledge
- Simulation with Monte-Carlo analysis

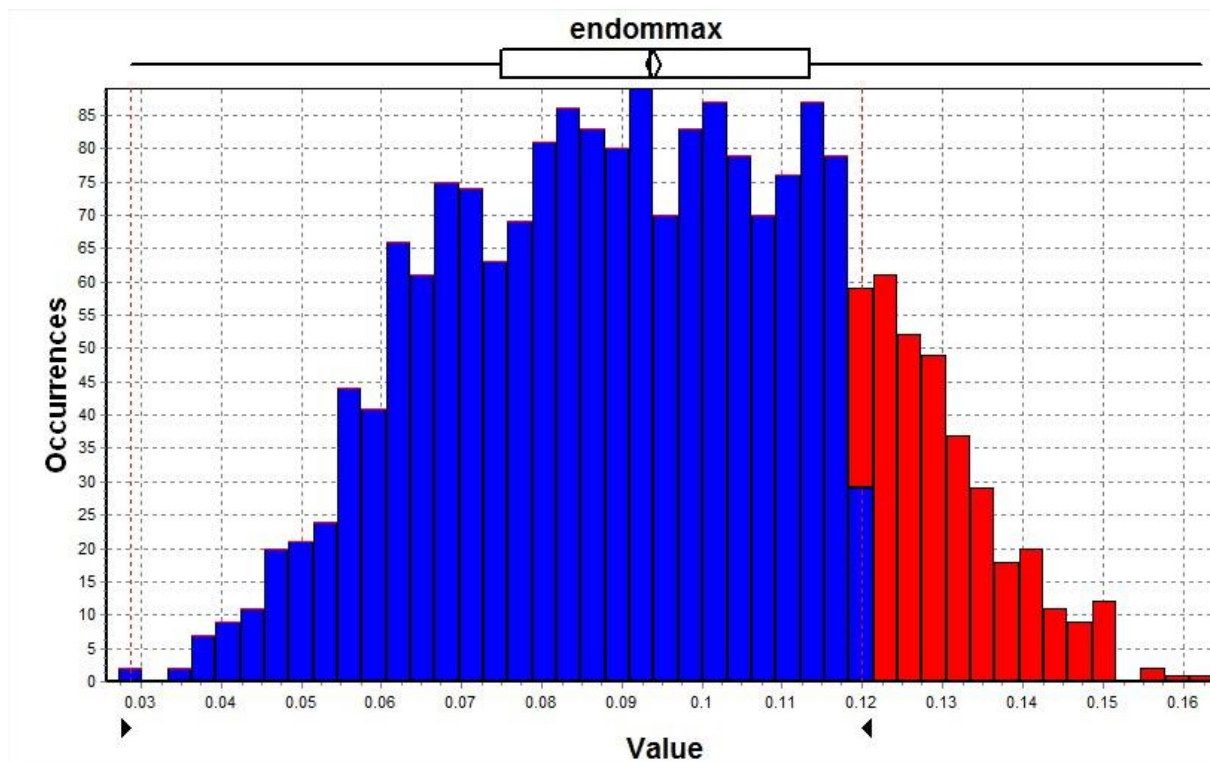

Moments		
Mean:		0.09401
Std Dev:		0.02479
Std Err Mean:		0.00055
Upper 95% Mean:		0.0951
Lower 95% Mean:		0.09292
N:		2000
Variance:		0.00061
Skewness:		0.01648
Kurtosis:		-0.68315
CV:		0.26372

Quantiles		
100.0%	maximum	0.16232
99.5%		0.14999
97.5%		0.14007
90%		0.12683
75%	quartile	0.1134
50%	median	0.0936
25%	quartile	0.07496
10%		0.06186
2.5%		0.04842
0.5%		0.03993
0.0%	minimum	0.0287

Reliability		
Lower Bound:	<input type="text" value="-Infinity"/>	
Upper Bound:	<input type="text" value="0.12"/>	
Reliability:		0.834

Plot Type		

# List of References

- [1] PAROISSIEN, E. *Contribution aux Assemblages Hybrides (Boulonnés/Collés). Application aux Jonctions Aéronautiques*. PhD Thesis, Paul Sabatier University (Toulouse 3), FR, (2006) . [http://thesesups.ups-tlse.fr/3/1/Paroissien\\_Eric.pdf](http://thesesups.ups-tlse.fr/3/1/Paroissien_Eric.pdf)
- [2] VOLKERSEN, O. *Die Nietkraftverteilung in Zugbeanspruchten Nietverbindungen mit konstanten Laschenquerschnitten* Luftfahrtforschung, Vol. 15, pp. 41-47 (1938)
- [3] TSAI, M.Y., OPLINGER, D.W., MORTON, J. *Improved theoretical solutions for adhesive lap joints*. *International Journal of Solids and Structures*, Vol. 35, n°12, pp. 1163-1185 (1998)
- [4] GOLAND, M., REISSNER, E. *The stresses in cemented joints*. *Journal of Applied Mechanics*, Vol. 11, pp. A17-27 (1944)
- [5] HART-SMITH, L.J. *Adhesive-bonded single-lap joints*. NASA, Technical Report CR-112235 (1973)
- [6] PAROISSIEN, E., GAUBERT, F., DA VEIGA, A., LACHAUD, F. *Elasto-Plastic Analysis of Bonded Joints with Macro-Elements*. *Journal of Adhesion Science and Technology*. Vol. 27, Issue 13, pp. 1464-1498 (July 2013)
- [7] PAROISSIEN, E., DA VEIGA, A., LABORDE, A. *An 1D-Beam Approach for Both Stress Analysis and Fatigue Life Predictions of Bonded Joints*. *Book of Proceedings of the 26th ICAF Symposium, Montréal (QC), 1-3 June 2011*, DOI 10.1007/978-94-007-1664-3, pp. 359-374 (2011)
- [8] PAROISSIEN, E., LACHAUD, F., JACOBS, T. *A Simplified Stress Analysis of Bonded Joints using Macro-Elements*. Chapter 4 of the book: *Advances in Modeling and Design of Adhesively Bonded Systems*, Editors K.L. MITTAL and S. KUMAR, Scrivener and Wiley Eds, pp. 93-147 (2013)
- [9] LELIAS, G., PAROISSIEN E., LACHAUD, F., MORLIER, J., SCHWARTZ, S., GAVOILLE, C. *An extended semi-analytical formulation for fast and reliable stress analysis of adhesively bonded joints* . Accepted on the 29<sup>th</sup> December of 2014 for publication to *International Journal of Solids and Structures*.
- [10] LACHAUD, F. *Contribution à l'analyse multi échelle du comportement mécanique non linéaire matériau des structures composites*. HDR ISAE, Université de Toulouse 3 (2011)
- [11] KHORAMISHAD, H., CROCMOBE, A.D., KATNAM, K. B., ASHCROFT, I.A. *Fatigue damage modelling of adhesively bonded joints under variable amplitude loading using a cohesive zone model*. *Preprint Eng Fract Mech, Vol. 78, Issue 18, pp. 3212-3225 (2011)*

