



**HAL**  
open science

# Emission Reduction and Economical Optimization of an Urban Microgrid Operation Including Dispatched PV-Based Active Generators

Hristiyan Kanchev, Frédéric Colas, Vladimir Lazarov, Bruno Francois

► **To cite this version:**

Hristiyan Kanchev, Frédéric Colas, Vladimir Lazarov, Bruno Francois. Emission Reduction and Economical Optimization of an Urban Microgrid Operation Including Dispatched PV-Based Active Generators. IEEE Transactions on Sustainable Energy , 2014, 5 (4), pp.1397-1405. hal-01890412

**HAL Id: hal-01890412**

**<https://hal.science/hal-01890412>**

Submitted on 8 Oct 2018

**HAL** is a multi-disciplinary open access archive for the deposit and dissemination of scientific research documents, whether they are published or not. The documents may come from teaching and research institutions in France or abroad, or from public or private research centers.

L'archive ouverte pluridisciplinaire **HAL**, est destinée au dépôt et à la diffusion de documents scientifiques de niveau recherche, publiés ou non, émanant des établissements d'enseignement et de recherche français ou étrangers, des laboratoires publics ou privés.

See discussions, stats, and author profiles for this publication at: <http://www.researchgate.net/publication/265855854>

# Emission Reduction and Economical Optimization of an Urban Microgrid Operation Including Dispatched PV-Based Active Generators

ARTICLE in IEEE TRANSACTIONS ON SUSTAINABLE ENERGY · OCTOBER 2014

Impact Factor: 3.66 · DOI: 10.1109/TSTE.2014.2331712

---

READS

64

## 4 AUTHORS:



**Hristiyan Kanchev**

Technical University of Sofia

17 PUBLICATIONS 173 CITATIONS

SEE PROFILE



**Frédéric Colas**

Ecole Nationale Supérieure d'Arts et Métiers

49 PUBLICATIONS 264 CITATIONS

SEE PROFILE



**Vladimir Lazarov**

Bulgarian Academy of Sciences

48 PUBLICATIONS 279 CITATIONS

SEE PROFILE



**Bruno Francois**

École Centrale de Lille

143 PUBLICATIONS 1,273 CITATIONS

SEE PROFILE

(Last version before publication)

# Emission reduction and economical optimization of an urban microgrid operation including dispatched PV-based active generators

Hristiyan Kanchev, Frederic Colas, *Member*, Vladimir Lazarov, Bruno Francois, *Senior Member*, IEEE

**Abstract**—In order to take full advantage of distributed generators, an evolution of the classical power system organization and management is also necessary. An aggregator of a residential urban electrical network can be considered by the Distribution System Operator as a stakeholder, which is able to control a cluster of local generators and loads with technical constraints for the connection with the remaining distribution grid and commercial contracts with outer electrical producers. This paper is focused on the design of the Microgrid Central Energy Management System which relies on a day ahead operational planning and an online adjustment procedure during the operation. A dynamic programming based algorithm is derived to solve the Unit Commitment Problem with a multiobjective function in order to reduce the economic cost and CO<sub>2</sub> equivalent emissions. The proposed energy management system is implemented into a SCADA and tested by using a hardware-in-the-loop simulation of the urban network. Economic and environmental gains are evaluated.

**Index Terms**—Distributed generators, energy efficiency, energy management system, microgrid, optimization, renewable energy, power generation planning, smart grid, storage

## I. INTRODUCTION

Research activities are more and more headed towards solutions for satisfying the ever growing energy demand.

In order to ensure a continuous development in a sustainable way, a considerable portion of the electrical energy has to be generated by Renewable Energy Based Generators (REBG). One of their main drawbacks is the non-constant nature of the primary energy source (solar irradiation, wind, ...). Hence, the increasing of renewable generators penetration into the energy mix could cause difficulties for system operators in matching the power production and demand thus degrading the quality of power supplied to the customers and further causing disruptions in power supply [1], [2]. Moreover further investments have to be made in conventional generators to create additional power reserve for compensating the cyclic and stochastic nature of renewable energy.

---

H. Kanchev is with the Technical University of Sofia (1000-Sofia, Bulgaria) and Ecole Centrale de Lille, L2EP (cite scientifique, CS 20048, 59650 Villeneuve d'Ascq, France), e-mail: hkanchev@tu-sofia.bg

V. Lazarov is with the Technical University of Sofia, (1000-Sofia, Bulgaria), e-mail: vl\_lazarov@tu-sofia.bg

B. Francois is with Ecole Centrale de Lille, L2EP, (CS 20048, 59650 Villeneuve d'Ascq, France), e-mail: bruno.francois@ec-lille.fr

F. Colas is with ENSAM-Lille, L2EP, (59046-Lille, France), e-mail: Frederic.colas@ensam.eu

Alternative to grid reinforcement could be a restructuring of the power system architecture and an increase of the share of Distributed Energy Resources (DER) that generate electricity at a local scale. Hence Micro Gas Turbines (MGT) based Combined Heat Production (CHP) and PV generators play an essential role for domestic small scale electricity generation. In this paper, only electrical production is considered.

A first restructuring strategy is to abandon feed-in tariffs and favor self-consumption of home produced electricity through incentives as experimented in Germany [3]. But this energy policy restricts the energy sharing for neighborhood customers and limits the energy security and the prevention of over investment in production plants by effect of expansion.

A further strategy is to transform actual PV generators into controllable Active Generators (AG) in order to offer new flexibilities for energy management of electrical networks. Thanks to embedded storage technologies and a dedicated local control algorithm, this generator is able to deliver prescribed power references, power system services and can be dispatched to the distribution system operator.

But the current electrical transmission and distribution networks are rather passive and centralized from the supervision point of view. This situation makes difficult the coordination of DER in the grid [3]. In order to coordinate power generation in an optimal way and to improve efficiency, reliability, security, the Smart Grid (SG) organization has to incorporate distributed intelligence and interactive communication at all levels of the electric network [4], [5].

A step towards the SG is to integrate locally REBG, conventional generators and loads in clusters called microgrids. These microgrids may be operated in islanded or connected mode (with the distribution grid) and can also provide ancillary services to the grid [6-8]. They must be locally aggregated and controlled by a Microgrid Central Energy Management System (MCEMS) (fig. 1). This aggregation can be considered by the Distribution System Operator (DSO) as a stakeholder, which is able to locally control a cluster of generators and flexible loads.

The main problem to overcome is to match locally the power demand and the production in an optimal way while minimizing the use of non-renewable energy sources for electricity generation and decreasing economic costs during operation (OPEX) [9]. Contributions of this paper are practical methods and solutions to design two stages of the MCEMS taking into account environmental and economic tasks.

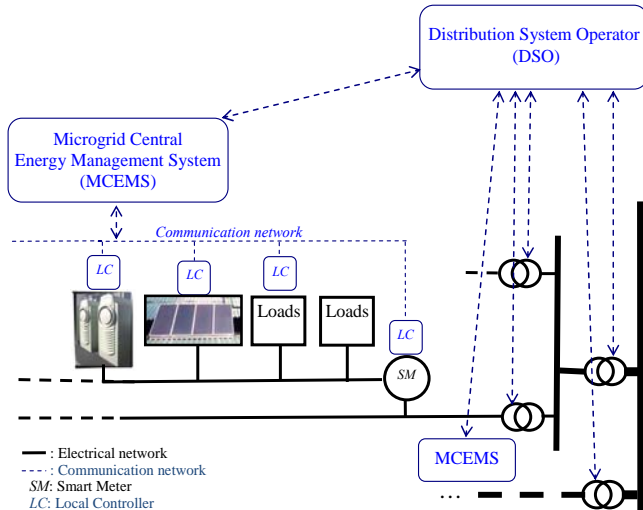

Fig. 1. SG based on the concept of microgrid integration

The first proposed stage is a day ahead operational planning for the minimization of CO<sub>2</sub> emissions and fuel consumption of an urban microgrid. This algorithm solves the Unit Commitment Problem (UCP) by the means of a dynamic programming with predictions of the available energy from PV generators, the power demand from the loads and the State Of Charge (SOC) of batteries inside active PV generators. Based on these data, this stage gives power references for micro gas turbines while maximizing the use of PV generators and reducing equivalent CO<sub>2</sub> emissions and the economic operating cost.

The second proposed stage is implemented during the day and consists in reducing variations due to the power uncertainty (from the PV production and load demand). This stage enables to retrieve day ahead calculated optimal economic costs and/or CO<sub>2</sub> emissions. An adjustment algorithm corrects, each 30 minutes, references coming from the day ahead operational planning, if changes in forecasted values occur. This adjustment algorithm is based on a sequential quadratic programming method. Both energy management functions can be implemented thanks to a communication network and the obtained complexity reduction of algorithms coming from the consideration of a cluster of generators and consumers.

This paper is organized as follows. In section II, the concept of AG is recalled. Then general functions for energy management of an electrical system are presented and ordered into the MCEMS for implementation in section III. As emissions and costs of primary energy come from micro gas turbines, manufacturer characteristics are derived to obtain a model useable for optimizations in section IV. Hence, the proposed day ahead operational planning is detailed in section V by adapting the formulation of the UCP to the studied power system, by mathematically expressing constraints and detailing the application of dynamic programming for the solving. Section VI is focused on the integration of an

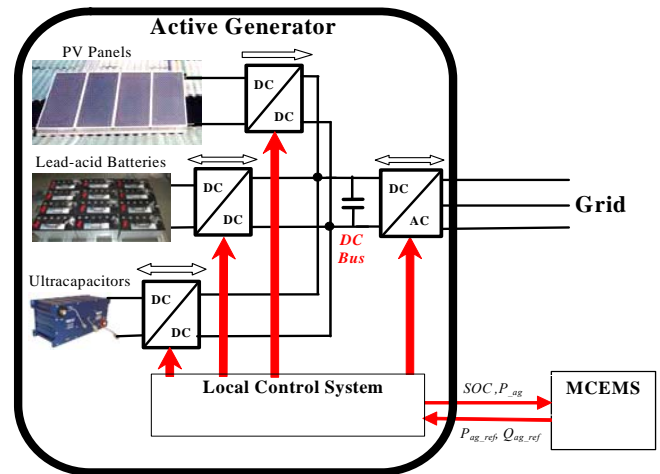

Fig. 2. Scheme of an AG including various storage technologies

adjustment procedure during the day in order to compensate deviations from the day ahead forecasted data of loads and PV power. Finally implementation of this MCEMS into a supervisory control and data acquisition (SCADA) of an urban microgrid is exposed in section VII. Results from various tested optimization tasks are given to compare obtained CO<sub>2</sub> emissions and costs according to the use of distributed MGTs alone, integration of dispatched PV based active generators with the proposed operational planning and adjustment algorithm.

## II. CONCEPT OF AG

Considered AG are based on a 3.6 kW PV generator, 106 Ah batteries and a 160 Farad supercapacitor bank (fig. 2). All components are connected to a common inner DC bus, which is interfaced to the electrical network through a three-phase inverter. Batteries are used to create a long term energy reserve and ultra-capacitors to supply power with very high dynamics. The inner instantaneous power balancing and power dispatching among the PV source and storage units according to the storage level capacity and to the specific requirements/limitations of each source are performed by a Local Controller (LC), whose functions are detailed in [10]. Real and reactive power references are received from the MCEMS. SOC of batteries and sensed powers at the connection point are sent to the MCEMS.

## III. MICROGRID ENERGY MANAGEMENT SYSTEM

The MCEMS must assign power references and also other appropriate control signals to the DER units, conventional production units and controllable loads [11]. The goals of the MCEMS algorithm are:

- to ensure uninterruptable power supply to the loads,
- to maximize renewable generators in the energy mix,
- to minimize the economic costs and the CO<sub>2</sub> equivalent emissions of gas turbines by setting their power references such, that they produce the minimum pollution and have minimum startups and shutdowns.

Many difficulties arise. First, the REBG power is variable and meets rarely the power request from the MCEMS. Moreover, there are numerous strategies for managing multiple gas turbines as auxiliary power sources for supplying loads (as example, a strategy may be to use the MGTs having

the highest maximum power output as a priority source). Finally, other turbine constraints exist as the minimum power set point, the response time ...

The microgrid management is analyzed through various functions that can be classified in a time scale. The long-term energy management elaborates a 24 hour-ahead operational planning including:

- the REBG production forecast taking into account the time dependency of the prime source, environmental impacts and cost of generation [12],
- the management of non-sensitive loads that may be disconnected/shed according to the supervision requirement,
- the provision of an appropriate level of power reserve capacity according to the electricity market and the load demand forecast,
- the maintenance intervals.

The medium-term energy management operates during the day and includes:

- the adjustment of forecasts for the power available from REBG and power demanded by the loads,
- the adjustment of the long-term operational planning, based on deviations in the above mentioned forecasts from those predicted 24 hour-ahead.

The short-term power balancing is performed in the local controllers and includes the primary RMS voltage regulation and the primary frequency control [13].

The long term operation schedule and the energy management can be mathematically expressed as an UCP. Due to the complexity of the problem, the required computation time may vary according to used optimization tools but the dynamic programming approach remains a good compromised choice [15].

#### IV. CHARACTERIZATION OF MICRO GAS TURBINES

##### A. Assessment of MGT Fuel Consumption

Fuel consumption of MGT can be assessed by using their partial load efficiency characteristics [16]. The energetic efficiency between thermal energy ( $F_{MGT_i}$  in kWh<sub>thermal</sub>) supplied to the gas turbine combustion chamber and electric energy output ( $E_{MGT_i}$  in kWh<sub>electric</sub>) is defined as:

$$\eta_i = \frac{E_{MGT_i}}{F_{MGT_i}} \quad (1)$$

$i$  is the unit number (we will consider 3 micro gas turbines). The efficiency characteristic is a nonlinear function depending on the partial load ratio (fig. 3):

$$\alpha_i(t) = \frac{P_{MGT_i}(t)}{P_{MGT_i\_MAX}} \quad (2)$$

$P_{MGT_i}$  (kW) is the generated MGT electric power,  $P_{MGT_i\_MAX}$  (kW) is the rated MGT electric power.

Based on (1) and (2) the consumed fuel thermal energy for a 30 minutes operation ( $\tau=1800s$ ) at constant electrical output power is obtained (fig. 4):

$$F_{MGT_i}(t) = \frac{\alpha_i(t) P_{MGT_i\_MAX} \tau}{\eta_i} \quad (3)$$

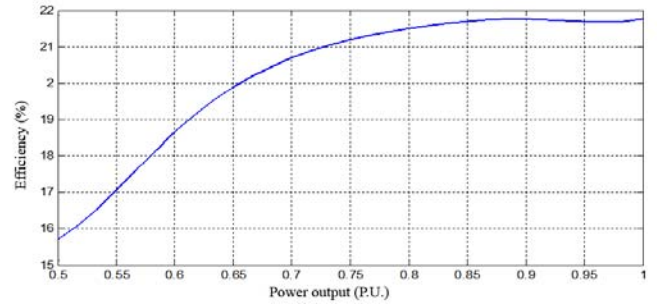

Fig. 3. Efficiency characteristic of MGT 2 (30kW)

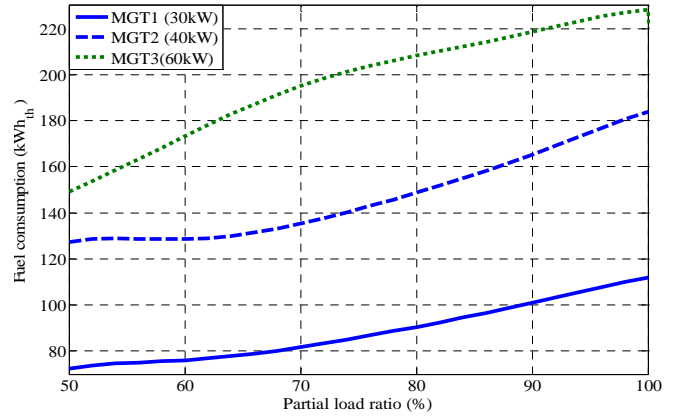

Fig. 4. Fuel power consumption of various MGT

By considering a 0,04 €/kWh<sub>thermal</sub> cost for the consumed gas, the operational cost of each generator ( $i$ ) is obtained from (3) as a function of the generated electric power  $P_{MGT_i}(t)$ :

$$C_i = f(P_{MGT_i}(t)) \quad (4)$$

##### B. Assessment of MGT Emissions

The CO<sub>2</sub> equivalent emissions are calculated by applying to the pollutant gases different weights corresponding to their global warming potential. For the assessment of emissions, the masses of the three exhaust gases, NO<sub>x</sub>, CO and CO<sub>2</sub> are evaluated in g/kWh as a mathematical function of the generated useful power [17]:

$$m_x(t) = \mu_x E_{MGT_i}(t) = \mu_x \alpha_i(t) P_{MGT_i\_MAX} \tau \quad (5)$$

$\mu_x$  (mg/kWh<sub>electric</sub>) is the emission factor (also called specific emissions) for the pollutant gas  $x$  to produce the generic useful electrical energy output  $E_{MGT_i}$  and  $m_x$  is the mass of the emitted pollutant gas  $x$ . The characteristic of CO<sub>2</sub> equivalent emissions of each MGT is expressed as a nonlinear function of its power output through a polynomial interpolation (fig. 5).

NO<sub>x</sub> are the most hazardous pollutant gases. The CO emissions are typically very low at full load operation, but are drastically increasing under partial loads, due to incomplete combustion and due to aging of the components or poor maintenance of the equipment. The CO<sub>2</sub> equivalent emissions are related to the global warming potential of MGT exhaust gases. CO and NO<sub>x</sub> are more dangerous as poison gases, but nevertheless they have a global warming potential, because

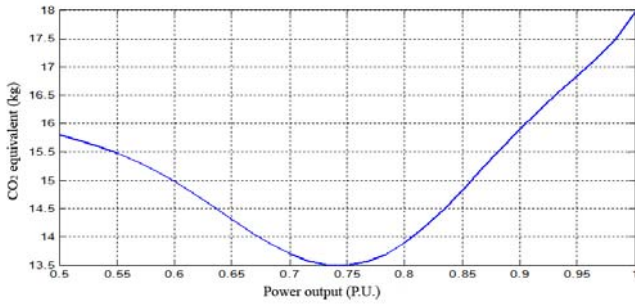
 Fig. 5. CO<sub>2</sub> equivalent emission characteristic of MGT No2 (30kW)

they are absorbed in the earth's atmosphere slower than CO<sub>2</sub>. This means that these gases also contribute to the greenhouse gas effect. Global warming potential has been estimated, according to [18]: 1 g of NO<sub>x</sub> has been considered equivalent to 298 g of CO<sub>2</sub> and 1 gram of CO equivalent to 3 g of CO<sub>2</sub>. The sum of the three characteristics (CO<sub>2</sub>, CO and NO<sub>x</sub>) according to the MGT partial load ratio represents the CO<sub>2</sub> equivalent emissions of each MGT [17].

In order to apply a multiobjective optimization procedure for a tradeoff between pollutant emissions and consumed fuel price, a price per ton of CO<sub>2</sub> equivalent emissions will be considered. According to economical researches in [20], the historical peak prices for trading a ton of CO<sub>2</sub> emission quota on the european market for industrials is equal to 30 euros. Practical and numerical applications in this paper will be developed with this price. According to a survey of the International Emissions Trading Association in 2013, an increase of emission prices in the European Union Emissions Trading Scheme to 10÷20 EUR/ton is highly probable by 2020 [22].

## V. DAY AHEAD OPTIMAL OPERATIONAL PLANNING

### A. Formulation of the Unit Commitment Problem

The 24 hour ahead operational planning is discretized in 48 time steps ( $t$ ) of 30 minutes and power references are considered constant during each step. For all time steps the operational planning consists in selecting MGT to be used, determining the instant they should be committed and calculating the optimal power references of each generator. Power references of the three studied MGT are gathered in a vector:

$$x(t) = [P_{MGT\ 1}(t), P_{MGT\ 2}(t), P_{MGT\ 3}(t)] \quad (6)$$

$\delta_i$  is the state of each MGT during each time step (1 if the plant is running or 0 if the plant is shut down). Boolean MGT states are gathered in a vector:

$$u(t) = [\delta_1(t), \delta_2(t), \delta_3(t)] \quad (7)$$

The general objective of unit commitment is to minimize the total operating cost of an electrical system, while satisfying all system constraints.

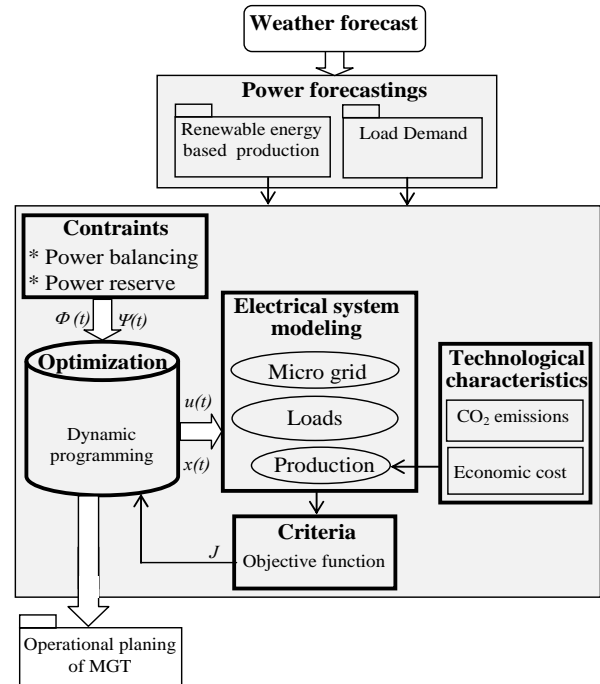

Fig. 6. Scheme of the day-ahead optimal operational planning

As the power industry goes to new restructured forms, the UCP must be adapted and applied to small DG clusters including REBG. So in this paper the UCP is used to formulate and solve our objective functions for cost minimization and CO<sub>2</sub> equivalent emissions reduction (fig.6).

### B. Objective functions

The CO<sub>2</sub> equivalent emissions of each generator and the cost of the consumed gas are expressed as a non-linear function of its power output and respectively called  $CO_{2\_i}(P_{MGT\_i}(t))$  and  $C_i(P_{MGT\_i}(t))$ .

Penalties for startup and shutdown of the units are also considered. If one unit is shut down in the current time step and will run in the next time step, a startup penalty is applied. If one plant will not be committed at  $t+1$  and it is running at  $t$ , a shutdown penalty is applied. The penalties avoid switching on and off the units because it increases the emissions and shortens the lifetime of the units. In this study, start-up penalty is considered equal to the consumed fuel cost during 5 minutes operation at full load. Shutdown penalty is considered equal to 2.5 minutes operation at full load. The startup and shutdown penalties are expressed by cost and CO<sub>2</sub> functions:  $C_{pe\_c\_i}(\delta_i(t+1), \delta_i(t))$  and  $C_{pe\_co2i}(\delta_i(t+1), \delta_i(t))$ .

The two objective functions to be minimized are defined as:

$$J_C(t) = \sum_{i=1}^{48} \sum_{i=1}^3 \delta_i(t) \cdot C_i(P_{MGT\_i}(t)) + C_{pe\_c\_i}(\delta_i(t+1), \delta_i(t)) \quad (8)$$

$$J_{CO_2}(t) = \sum_{i=1}^{48} \sum_{i=1}^3 \delta_i(t) \cdot CO_{2\_i}(P_{MGT\_i}(t)) + C_{pe\_co2i}(\delta_i(t+1), \delta_i(t)) \quad (9)$$

$P_{MGT\_i}(t)$  is the generated power. Maintenance and management costs are outside of the scope of this paper.

### C. Non-linear constraints

Day ahead planning strategies use renewable energy based production and load forecasts. With  $N$  active generators and  $M$  micro gas turbines, the power balancing between the loads ( $P_L$ ) and the generators ( $P_{AG\_n}$  and  $P_{MGT\_i}$ ) in each time step must be performed with a maximum use of the “clean” PV energy. This is expressed as an equality constraint:

$$\psi(t) = P_L(t) - \sum_{n=1}^N P_{AG\_n}(t) - \sum_{i=1}^3 \delta_i(t) \cdot P_{MGT\_i}(t) = 0 \quad (10)$$

The micro gas turbine loading level has to be higher than 50% of the MGT's rated power for improving efficiency (fig. 3) and reducing CO<sub>2</sub> equivalent emissions (fig. 5). Moreover the power in reserve must be equal to or larger than 10% of the generator rated power. The corresponding inequality constraint ( $\Phi(t)$  in fig.6) is expressed as:

$$50\% P_{MGT\_max\_i} \leq P_{MGT\_i} \leq 90\% P_{MGT\_max\_i} \quad (11)$$

A last group of constraints refers to the microgrid operation mode [23], [24]. The constraints differ from one mode of operation to another (day/night, PV power available or not, AG's battery state of charge) and are taken into account in part E.

The MCEMS does not control the SOC of embedded storage units in various AG since it is managed by the corresponding local controller.

### D. Application of the Dynamic Programming

Several approaches can be applied to implement an optimization procedure to solve the UCP by minimizing equ. (10) and (11). The optimal solution of the Bellman's recursive equation for all time steps is used to construct the optimal solution of the overall problem [24], [25].

For one state of MGT's ( $u(t)$ ), the operational cost is expressed as:

$$\begin{aligned} & - \text{the cost of electricity production during the time step } [(t-1), t] \\ & \sum_{i=1}^3 \delta_i(t) \cdot C_i(P_{MGT\_i}(t)) \end{aligned} \quad (12)$$

- and the cost during the previous time step taking into account the transition cost due to the start or stop of generators

$$Tr(u(t-1), u(t)) = F(t-1, u(t-1)) + \sum_{i=1}^3 C_{pe\_i\_c}(\delta_i(t-1), \delta_i(t)) \quad (13)$$

At step  $t$ , the unit commitment problem formulation for the studied system can be expressed in the form of the following recursive dynamic programming equation:

$$F(t, u(t)) = \sum_{i=1}^3 \delta_i(t) \cdot C_i(P_{MGT\_i}(t)) + Tr(u(t-1), u(t)) \quad (14)$$

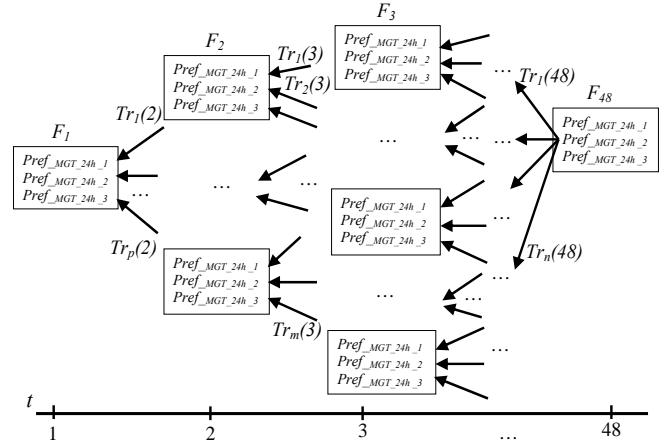

Fig. 7. Principle of optimal path by dynamic programming

The optimal solution of the overall problem is obtained by selecting the optimal values of control variables in the previous equation for all time steps recursively from  $t=48$  to  $t=1$  as depicted in fig. 7 ([26], [27] and [28]). In a same way, a similar formulation can be found to evaluate CO<sub>2</sub> emissions:

$$F(t, u(t)) = \sum_{i=1}^3 \delta_i(t) \cdot CO_{2-i}(P_{MGT\_i}(t)) + Tr(u(t-1), u(t)) \quad (15)$$

With

$$Tr(u(t-1), u(t)) = F(t-1, u(t-1)) + \sum_{i=1}^3 C_{pe\_co2\_i}(\delta_i(t-1), \delta_i(t)) \quad (16)$$

### E. Strategy for maximisation of renewable penetration

In order to give a priority to AG, their power references are first calculated. Then, power references of MGT's will satisfy the remaining power balancing if necessary. According to the available PV power and stored energy in batteries, three cases have been considered (fig. 8). During the day, if the predicted PV power ( $\tilde{P}_{PV\_24h\_n}$ ) is enough to feed the predicted load demand ( $\tilde{P}_{Load\_24h}$ ), then power references of  $N$  active generators are set to limit the total generated power (all AG's are closed and have the same PV power sizing):

$$P_{Ref\_AG\_24h\_n}(t) = \frac{\tilde{P}_{Load\_24h}(t)}{N} \quad (17)$$

The energy surplus is automatically saved in batteries by the local control system of active generators and can be estimated:

$$\sum_{n=1}^N E_{Bat\_n}(t+1) = \sum_{n=1}^N E_{Bat\_n}(t) + \left[ \tilde{P}_{Load\_24h}(t) - \sum_{n=1}^N P_{Ref\_AG\_24h\_n}(t) \right] \cdot 1800 \quad (18)$$

Otherwise, power references of AG's are set to the predicted values:

$$P_{ref\_AG\_24h\_n}(t) = \tilde{P}_{PV\_24h\_n}(t) \quad (19)$$

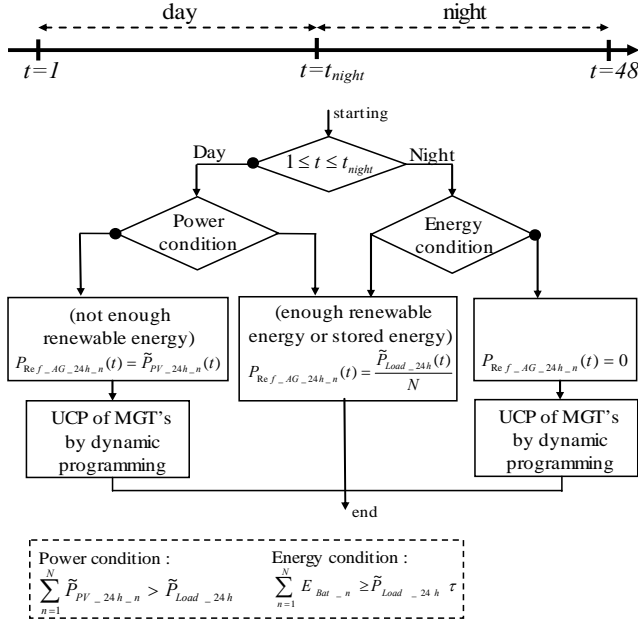

Fig. 8. Power reference calculation and dispatching.

And power references of MGT must balance the remaining power:

$$\sum_{i=1}^3 P_{ref\_MGT\_24h\_i}(t) = \tilde{P}_{Load\_24h}(t) - \sum_{n=1}^N P_{ref\_AG\_24h\_n}(t) \quad (20)$$

Then the dynamic programming algorithm considers all possible states of MGT and, for each one, power references of MGT are calculated by a quadratic optimization algorithm (satisfying previous equation).

During the night, if the stored energy in batteries is enough to feed the predicted load demand, MGT are switched off and power references of AG's are set to limit the total generated power:

$$P_{ref\_AG\_24h\_n}(t) = \frac{\tilde{P}_{Load\_24h}(t)}{N} \quad (21)$$

Calculation of battery SOC can be refreshed:

$$\sum_{n=1}^N E_{Bat\_n}(t+1) = \sum_{n=1}^N E_{Bat\_n}(t) - \tau \tilde{P}_{Load\_24h}(t) \quad (22)$$

Otherwise, power references of MGT's must balance the remaining power:

$$\sum_{i=1}^3 P_{ref\_MGT\_24h\_i}(t) = \tilde{P}_{Load\_24h}(t) \quad (23)$$

And, again, the dynamic programming algorithm considers all possible states of MGT's and their power references are calculated by a quadratic optimization algorithm.

## VI. ON LINE ADJUSTMENT

The AG is capable of maintaining a prescribed power reference ( $P_{ref\_AG\_24h\_n}$ ), received from the MCEMS, in the limits imposed by the actual SOC of the batteries. According to the daily predictions of the available power from the PV ( $\tilde{P}_{PV\_24h}$ ) and the required power of the loads ( $\tilde{P}_{Load\_24h}$ ), a day ahead power production planning for the AG and for micro turbines is determined by the MCEMS. Sometimes the real situation (weather conditions, power demand by loads)

could differ from the forecasted values. As a 10% power reserve is scheduled in power references of MGT (equ (3)), instantaneous deviations due to the power unbalancing can be handled by the primary controllers of local controllers.

Current forecasting techniques allow us to have an updated forecast every 30 minutes. In practice, the current forecasted loads ( $\tilde{P}_{Load\_t+1}$ ) and forecasted PV production ( $\tilde{P}_{PV\_t+1}$ ) for the next 30 minutes (time step  $t+1$ ) are considered. The deviation from the day ahead forecasted data ( $\tilde{P}_{PV\_24h(t+1)}$  and  $\tilde{P}_{Load\_24h(t+1)}$ ) is expressed as:

$$\Delta P_{PV\_t+1} = \tilde{P}_{PV\_24h\_t+1} - \tilde{P}_{PV\_t+1} \quad (24)$$

$$\Delta P_{Load\_t+1} = \tilde{P}_{Load\_24h\_t+1} - \tilde{P}_{Load\_t+1} \quad (25)$$

During the day the on line adjustment of the MCEMS consists in modifying AG power references each 30 minutes so that primary power reserves of MGT are not used and so that their produced power are as close as possible to the optimal operational point as calculated one day ahead. Deviations are taken into account by modifying power references of the generators according to the new situation:

$$P_{AG\_ref\_t+1} = \tilde{P}_{AG\_ref\_24h\_t+1} + \Delta P_{PV\_t+1} \quad (26)$$

$\tilde{P}_{AG\_ref\_24h\_t+1}$  is the AG power reference, calculated one day ahead by the MCEMS.

A correction in power references for the micro gas turbines in the system may be also necessary. If the power deviation from forecasted values is larger than 10%, the algorithm has to switch on a turbine that was not planned to be run at  $t+1$  in order to compensate the lack of PV power.

## VII. TEST OF THE MCEMS AND APPLICATION

### A. Implementation in a SCADA and Used Test-Bed

In industry, SCADA systems encompass the transfer of data between a central host computer and Transmission Control Protocol / internet Protocol (TCP/IP) remote terminal units (RTUs) or programmable logic controllers (PLCs) embedded in generators, gather and display information in a logical and organized fashion, carry out necessary analysis and control, execute sequential commands of remote devices, and transfer the information back to a central site.

The implementation of our proposed MCEMS in a SCADA needs to add centralized remote control and TCP/IP network. So, a test in real scenarios is required to evaluate the performance of the developed solution and to detect necessary adaptations before it will be implemented in the distribution system. For security reason, this test cannot be done directly in real situations onto a power system under operation. Moreover precise energy scenarios have to be played in order to valid the correct interactivity between the MCEMS and RTUs. So a test-bed has been developed and is based on a real time simulator (RTS), which is connected to the laboratory grid through a 30kW power amplifier (Fig. 9).



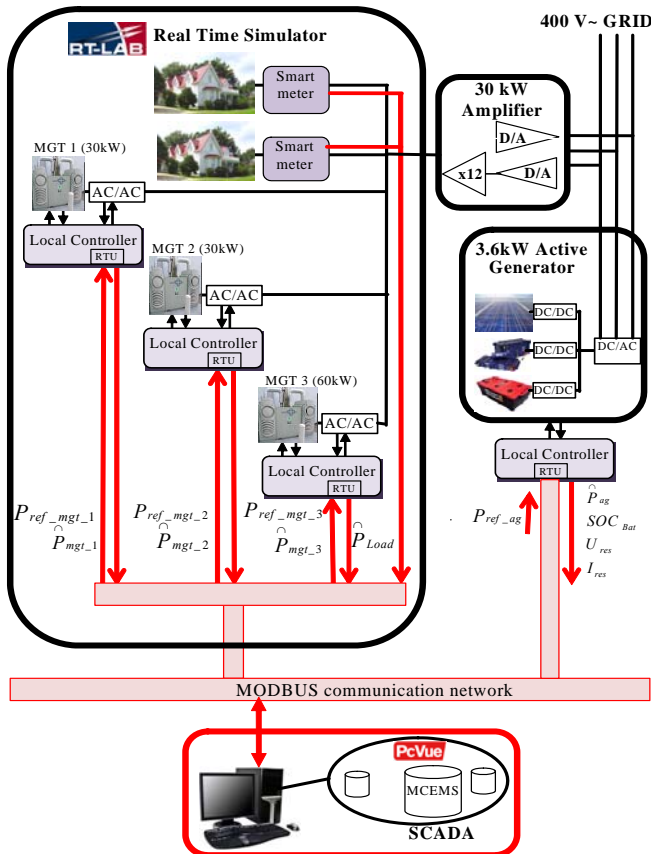

Fig. 9. Schematic diagram of the Power Hardware In the Loop.

The RTS is also connected to the SCADA, which executes the MCEMS (coded in the PcVue software), via a MODBUS communication network. The three micro gas turbines and the loads are simulated in RTS and the other equipment are real: the communication network, one active generator and the SCADA system. A real prototype of the AG is also connected to the grid and monitored by the SCADA (Fig. 10). The feedback loop of local control systems is closed by implemented current/voltage measurements at the clamp. Models of residential loads, but also RTU, local controllers and models of gas micro turbines are embedded in the RTS and executed in real time. This test-bed enables to reproduce identical demand scenarios under various sun conditions in order to validate the day ahead operational planning and the adjustment algorithm and to test various optimization goals.

### B. Presentation of the Application

The studied urban microgrid includes residential loads, two 30kW MGT, one 60kW MGT and twelve homes with 3,6 kW PV based AG's with embedded storage (fig. 11). All power generators and electrical loads are locally connected. So line losses and voltage drops can be ignored. As twelve generators must be considered and are very closed in the urban network (so they receive the same solar irradiation), the measured output power of the real single active generator is multiplied by 12.



Fig. 10. Overview of our SCADA system.

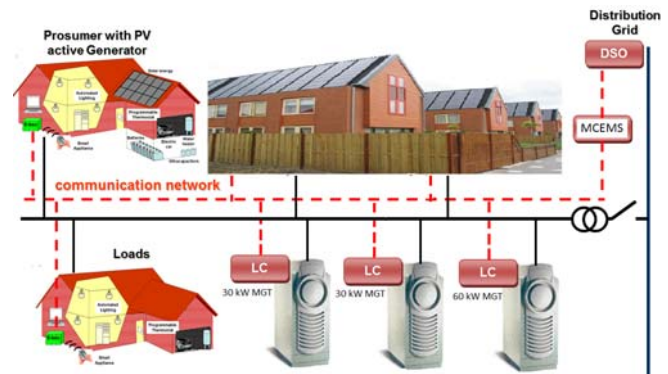

Fig. 11. Schematic diagram of the urban microgrid

The microgrid central controller measures the microgrid state variables and dispatches power references (refreshed by the adjustment algorithm every half of an hour) to micro sources through a communication network. LC receive these power set points. In the same time they send various data, as example the sensed power production at the coupling point.

### C. Experimental Results

First, a basic dispatching strategy without PV generators and optimization has been experimented with the load demand forecast (fig. 12). It consists in setting MGT power references proportional to the generator rated power while the added power references corresponds to the remaining power required by loads. Then PV based AG's are considered and their calculated global power references from the strategy for the maximization of the renewable penetration are shown on fig.13.

The dynamic programming based optimization procedure has been performed with three different objective functions: minimization of the CO<sub>2</sub> equivalent emissions from the micro-gas turbines, the consumed fuel and a tradeoff between these two functions. Results in table I show that any of the three objective functions causes about 10% reduction in the total operational cost (the cost of CO<sub>2</sub> equivalent emissions and the cost of consumed fuel), compared to the same system without optimization of the operational planning.

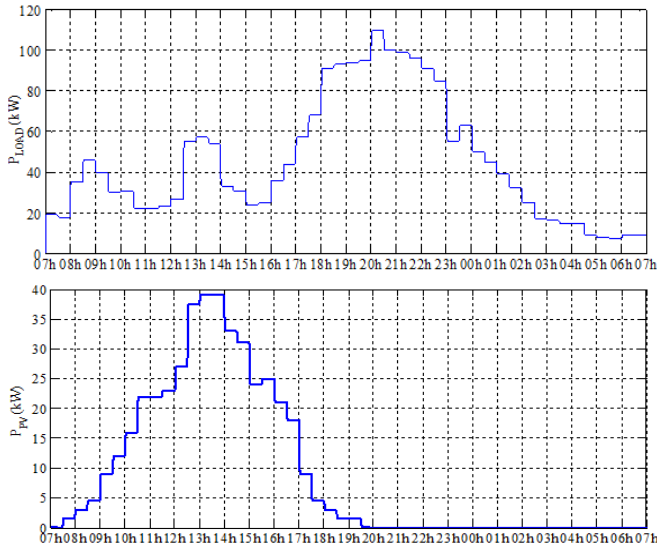

Fig. 12. Day ahead load forecast (kW) and PV power forecast in MPPT (kW)

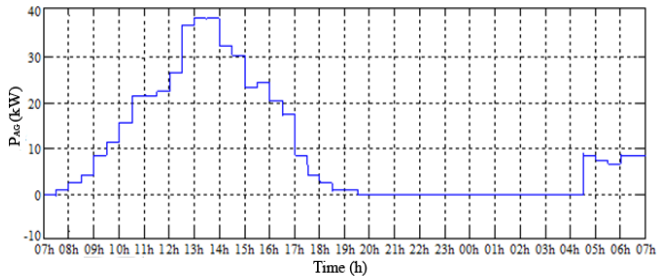

Fig. 13. Global power reference of PV based AG's

TABLE I DAY AHEAD OPERATIONAL PLANNING RESULTS

	CO <sub>2</sub> cost	Fuel cost	Total cost
<b>Without optimization</b>	50€	153€	203€
<b>Mono-objective (CO<sub>2</sub>)</b>	35€(-30%)	147€(-4.2%)	181€(-10.7%)
<b>Mono-objective (Fuel)</b>	36€(-28.7%)	146€(-4.6%)	183€(-10.1%)
<b>Multi-objective</b>	35€(-29.3%)	147€(-4.1%)	182€(-10.3%)

There is not a great difference in the overall cost between the different objective functions because, in fact, the CO<sub>2</sub> equivalent emissions and the consumed fuel are not really independent functions: the fuel consumption is used in the calculation of the CO<sub>2</sub> emissions, which is then used in the calculation of CO<sub>2</sub> equivalent emissions. Thus minimizing either the CO<sub>2</sub> equivalent emissions or the consumed fuel is enough for approximating very well the optimal system operation.

A statistical analysis of sensed powers from MGT has been done without optimization and with an optimized operational planning under the same scenario (fig. 14 and fig. 15). Results prove that the optimization algorithm selects power references such that MGT operate more frequently in the domain between 0.7 and 0.8 p.u. Operation in this region causes less CO<sub>2</sub> equivalent emissions, as depicted in fig. 5.

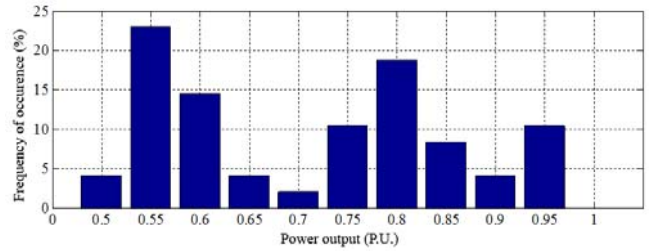

Fig. 14. Occurrence of MGT 2 power set points without optimization

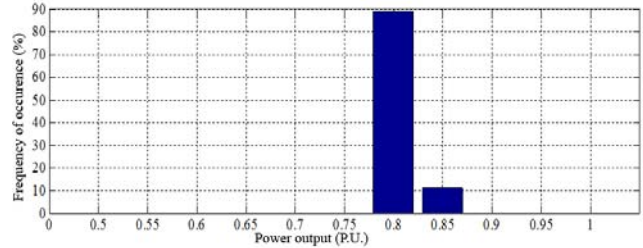

Fig. 15. Occurrence of MGT 2 power set points using the CO<sub>2</sub> equivalent emissions as objective function.

### VIII. CONCLUSION

A day ahead operational planning has been proposed to calculate power references of DER in order to optimize CO<sub>2</sub> emissions and the operational economic cost. A dynamic programming approach is used for solving the unit commitment problem in the studied microgrid. Based on the load and PV production forecasts, the MGT characteristics, startup and shutdown penalties and the SOC of AG batteries, the algorithm searches by recursion the optimal path through all possible system states in the 24 hour-ahead operational planning. Deviations in forecasted values are compensated by an adjustment algorithm that recalculates power references for the generators if the difference between day-ahead forecasted values and one hour ahead forecasts is greater than the 10% power reserve. This algorithm enables to retrieve day ahead optimized values while satisfying the power balancing.

This MCEMS has been implemented into a SCADA and tested to manage an urban microgrid simulated in real time. Four different scenarios have been considered: without optimization of the operational planning and optimization with three different objective functions: minimization of the CO<sub>2</sub> equivalent emissions from the micro-gas turbines, minimization of the consumed fuel or a tradeoff between the two. Results demonstrate that using any of the three objective functions, a reduction of not less than 10% in the system total operational cost is achieved, compared to the same system without optimization of the operational planning.

### REFERENCES

- [1] K. V. Bhadane, M. S. Ballal and R. M. Moharil, "Investigation for causes of poor power quality in grid connected wind energy – a review", Asia-Pacific Power and Energy Engineering Conf. (APPEEC), Shanghai, China, 27-29 March, 2012.
- [2] Robyns B., Davigny A., B. Francois, B., Henneton A. and Sprooten J., Electricity Production from Renewable Energies, ISTE Ltd and John Wiley & Sons, ISBN 978-1-84821-390-6, 2012.
- [3] B. Ernst, B. Engel, "Grid integration of distributed generation", 2012 IEEE Power and energy Society General Meeting (PES 2012) proceedings, 22 – 26 July, San Diego, USA, 2012

- [4] A. Gaviano, K. Weber and C. Dirmeier, "Challenges and integration of PV and wind energy facilities from a Smart Grid point of view", Elsevier Energy Procedia, vol. 25, pp. 118-125, 2012.
- [5] F. Li, W. Qiao, H. Sun, H. Wan, J. Wang, Y. Xia, Z. Xu and P. Zhangl, "Smart Transmission Grid: Vision and Framework", IEEE Trans. on Smart Grid, vol.1, no.2, pp. 168 – 177, Sept. 2010.
- [6] X. Fang, S. Misra, G. Xue and D. Yang, "Smart Grid – The new and improved power grid: A survey", IEEE Communications Surveys & Tutorials, vol. 14, no. 4, pp. 944-980, Oct. 2012.
- [7] H. Farhangi, "The path of the smart grid", *IEEE Power and Energy Magazine*, vol. 8, no. 1, pp. 18–28, Jan. 2010.
- [8] J. M. Guerrero, M. Chandokar, T. Lee and P. C. Loh, "Advanced control architectures for intelligent microgrids – part I: decentralized and hierarchical control", IEEE Trans. on Industrial Electronics, vol. 60, no. 4, pp. 1254-1262, Apr. 2013.
- [9] Y. Zhang, N. Gatsis, and G. Giannakis, "Robust Energy Management for Microgrids With High-penetration Renewables", IEEE Trans. on Sustainable Energy, Vol. 4, Iss. 4, pp. 944 – 953, Oct. 2013
- [10] C. Marnay, G. Venkataramanan, M. Stadler, A.S. Siddiqui, R. Firestone, B. Chandran, "Optimal Technology Selection and Operation of Commercial-Building Microgrids", IEEE Trans. on Power Systems, vol. 23, no.3, pp. 975-982, August 2008
- [11] H. Kanchev, D. Lu, F. Colas, B. Francois and V. Lazarov, "Energy management and operational planning of a microgrid with a PV-based active generator for Smart Grid Applications", IEEE Trans. on Industrial Electronics, vol.58, no.10, pp. 4583 – 4592, 2011.
- [12] S. Ahn, S. Nam, J. Choi and S. Moon, "Power scheduling of distributed generators for economic and stable operation of a microgrid", IEEE Trans. on Smart Grid, vol.4, no.1, pp. 398-405, 2013.
- [13] P. Li, P. Degobert, B. Robyns, B. Francois, "Participation in the frequency regulation control of a resilient microgrid for a distribution network", International Journal of Integrated Energy Systems, Vol.1, no.1, pp.61-67, 2009.
- [14] Y. A. Mohamed, A. A. Radwan, "Hierarchical control system for robust microgrid operation and seamless mode transfer in active distribution systems", IEEE Trans. on Smart Grid, vol.2, no.2, pp. 352-362, 2011.
- [15] T. Longenthiran, D. Srinivasan, "Formulation of Unit commitment (UC) problems and analysis of available methodologies used for solving the problems", IEEE International Conf. on Sustainable Energy Technologies (ICSET), Kandy, Sri Lanka, 6-9 December, 2010.
- [16] A. Boicea, G. Chicco and P. Mancarella, "Optimal operation of a microturbine cluster with partial-load efficiency and emission characterisation", IEEE Powertech conf., Bucharest, Romania, 2009.
- [17] A. Canova, G. Chicco and P. Mancarella, "Assessment of the Emissions due to Cogeneration Microturbines under Different Operation Modes", POWERENG 2007, Setubal, Portugal, April 12-14, 2007.
- [18] Intergovernmental Panel on climate change (IPCC), "Climate change 2007: The Physical Science Basis", chap. 2, p. 212, table 2.14, ISBN 978-0-521-88009-1
- [19] Y. Qin, X. Er-shu and Y. Yong-ping, "Pollutant Emission Reduction Analysis of Distributed Energy Resource", Int. Conf. on Bioinformatics and Biomedical Engineering, Shanghai, China, 16-18 May, 2008.
- [20] L. M. Abadie and J. M. Chamorro, "European CO<sub>2</sub> prices and carbon capture investments", Elsevier Energy Economics, vol. 30, no.6 pp. 2992-3015, November 2008.
- [21] A. Bowen, The case for carbon pricing, Grantham Research Institute on Climate Change and Environment, London School of Economics and Political Science, December 2011.
- [22] International Emissions Trading Association (IETA), "GHG market sentiment survey – 2013", pp.6, fig. 4, www.ieta.org.
- [23] H. Kanchev, D. Lu, B. Francois and V. Lazarov, "Smart monitoring of a microgrid including gas turbines and a dispatched PV-based active generator for energy management and emissions reduction", Innovative Smart Grid Technologies (ISGT) Conf. Europe, Gotheburg, 2010
- [24] H. Kanchev, B. Francois and V. Lazarov, "Unit commitment by dynamic programming for microgrid operational planning optimization and emission reduction", Aegan Conf. of Electrical Machines and Power electronics & Electromotion conf., Istanbul, Turkey, 08-10 Sept., 2011.
- [25] T. Hu, T. Wu, J. Song et al., "A new tree structure for weighted dynamic programming based stereo algorithm", 6<sup>th</sup> Int. Conf. on Image and Graphics (ICIG'11), Hefei, China, 11-15 August, 2011, pp. 100-105.
- [26] P. K. Singhal and R.N. Sharma, "Dynamic programming approach for solving power generating unit commitment problem", 2<sup>nd</sup> International

Conf. on Computer and Communication Technology (ICCT'11), Allahabad, India, 15-17 Sept., 2011, pp.298-303.

- [27] H. Kanchev, B. Francois and V. Lazarov, "Algorithm for operational planning and emissions reduction of a microgrid comprising gas turbines and PV-based active generators", *Innovative Smart Grid Technologies (ISGT) Eur.*, CD-ROM, Manchester, U.K., Dec. 5-7, 2011.
- [28] H. Kanchev, V. Lazarov and B. Francois, "Environmental and economic optimization of microgrid long term operational planning including PV-based active generators", *Proc. ECCE Eur. Power Electron. and Motion Control Conf. (EPE-PEMC)*, CD-ROM, Novi Sad, Serbia, Sept. 3-6, 2012.
- [29] H. Kanchev, B. Francois and V. Lazarov, "Operational planning and optimization for fuel consumption minimization of a microgrid comprising PV based active generators", 8<sup>th</sup> Power Plant & Power System Control Symposium (PPS2012), Toulouse, 2–5 Sept., 2012.



**Hristiyan Kanchev** was born in 1984 in Sofia, Bulgaria. He received his master's degree in electrical engineering in 2008 from the Technical University of Sofia (TUS) and his Ph.D. degree both from TUS and Ecole Centrale de Lille (France) in 2014. His field of interest includes renewable energy sources, distributed electricity generation, energy management and micro grids.

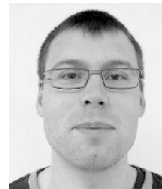

**Frederic Colas (M'11)** was born in 1980 in Lille, France. He received his Ph.D. degree in control system from Ecole Centrale de Lille, France in 2007. He is a research engineer at the department of Electrical Engineering in Arts et Metiers ParisTech and he is a member of Laboratory of Electrical Engineering (L2EP), Lille. He is currently working on the integration of renewable energy in power system, on the theory of virtual power plant and on te real-time simulation devoted to power systems.



**Bruno Francois (M'96-SM'06)** was born in Saint-Amand-les-Eaux, France, on January 19, 1969. He received the PhD degree in electrical engineering in 1996 from the University of Science and Technology of Lille (USTL), France. He is Professor at the Department of Electrical Engineering of Ecole Centrale de Lille. He is a member of Laboratory of Electrical Engineering (L2EP), Lille. He is currently working on advanced energy management systems



**Vladimir Lazarov** was born in Sofia, Bulgaria. He received the Ph.D. degree from the Technical University, Sofia, Bulgaria, in 1993. Currently he is working with the Faculty of Electrical Engineering, Technical University and is head of the laboratory on Renewable Energy. His research interests include electrical machines with electronic switching, small electrical machines and renewable energy sources (electrical aspects).