



HAL
open science

Study on Dynamic Characteristics of Rotor-bearing Model in the Hydraulic-mechanical-electric Coupled System of Hydro Generator Unit

Zhenyue Ma, Qianqian Wu

► To cite this version:

Zhenyue Ma, Qianqian Wu. Study on Dynamic Characteristics of Rotor-bearing Model in the Hydraulic-mechanical-electric Coupled System of Hydro Generator Unit. 16th International Symposium on Transport Phenomena and Dynamics of Rotating Machinery, Apr 2016, Honolulu, United States. ⟨hal-01890083⟩

HAL Id: hal-01890083

<https://hal.science/hal-01890083v1>

Submitted on 8 Oct 2018

HAL is a multi-disciplinary open access archive for the deposit and dissemination of scientific research documents, whether they are published or not. The documents may come from teaching and research institutions in France or abroad, or from public or private research centers.

L'archive ouverte pluridisciplinaire **HAL**, est destinée au dépôt et à la diffusion de documents scientifiques de niveau recherche, publiés ou non, émanant des établissements d'enseignement et de recherche français ou étrangers, des laboratoires publics ou privés.



HAL Authorization

Study on Dynamic Characteristics of Rotor-bearing Model in the Hydraulic-mechanical-electric Coupled System of Hydro Generator Unit

Zhenyue MA^{1*}, Qianqian Wu¹



Abstract

A hydraulic-mechanical-electric coupled model for hydroelectric shaft-bearing system was established, which contains the penstock model of water-carriage system, the model of governor system and the model of exciter system. A differential equations for coupled model, consisting of the key parameters from different systems (such as head, flow, speed and exciting current), were established and solved simultaneously. Further, a rotor-bearing system model is coupled to the whole system by User Programmable Features (UPFs). On this basis, a newly method which was focused on the study of rotor system dynamic nonlinear properties during the process of operation condition's changing was introduced. In this paper, the model was applied in the rotor dynamic analysis in applicable start-up laws with different parameters. This analysis method could provide a reference to the stable and optimum operation of hydro generator units.

Keywords

hydraulic-mechanical-electric coupled — rotor-bearing system —UPFs

¹ School of Hydraulic Eng., Dalian University of Technology, Dalian City, P. R. China

*Corresponding author: dmzy@dlut.edu.cn

INTRODUCTION

The operation of hydro generator is a complex process with hydraulic-mechanical-electric coupled. A coupled hydro-power system contains the hydro-turbine system, speed control system and generator system, which is involved in hydraulic transient model, mechanical transient and the electric-magnetic transient study, respectively.

The hydro-turbine system may be simplified as linear model and nonlinear model. For the linear model, more assumptions are built (such as non-elastic water, the proportional relationship between flow and gate position and so on), on the other hand, the nonlinear relationship of the turbine output, the turbine flow, the turbine head and the gate opening are considered in the study of nonlinear model. A linear model was used to study the factors' value for operating stability with small load variation by Hovey [1]. With taking into consideration the compressibility of water and elastic of penstock, Wozniak and Fett [2] established a nonlinear model, and special emphasis was given to the pressure conduit in its properties which were mentioned above. On the basis of nonlinear model, Sanathanan [3] discussed the accuracy of the low order model for hydro-turbine with long penstock. Similarly, Kishor et al. [4] and Vournas [5] too has proposed low order models for above study. In papers [6][7], several hydropower plant models of linear and nonlinear were reported by IEEE group to research the effects of non-elastic and elastic water column on the plant. In recent years, many researchers give significant focus on the model... Over the past decades, many studies were carried out for the control theory of hydro-turbine governor system. A fundamental and pioneering study

has been done by Paynter [8], Hovey and Leum [9], while, their papers established general guiding for hydro-turbine control theory. The permanent droop and generator damping which are neglected by above studied, are considered into the governor models in the papers of Chaudhry [10] and others researchers [11]. The PID control strategy is developed and studied for hydro-turbine control by many literatures until recent years. And with the development of computer technology, there is growing concern about the digital control system [12][13][14] which is more sensitivity than conventional control system. In modern research, more control theory were developed such as optimal control, nonlinear control, adaptive control, robust control and so on [15][16][17][18][19].

The model of rotor-bearing system is the core component of hydropower generator unit. Mostly, the model is consisted of the shaft, the rotor, the turbine and the support structure. The dynamic characteristics of this model are the objective for researchers to study, while the vibration of the rotor system is mainly affected by the source which coupled hydraulic, mechanical and electric factors. The self-excitation oscillation of water seal for turbine has discussed by many papers. The dynamic response of rotor system under the axial thrust from water is studied in paper [20]. The magnetic effect on the system commonly manifested as a unbalanced magnetic pull on the rotor centre. The eccentric force of rotor and turbine is the mechanical effect.

All of studies in the past of the transient (or coupled transient) and the rotor system are independent. For the former the objective is mainly focus on the stability of the control/power system or condition's change on the basis of parameters optimization. The latter gives a significant

attention to the structure dynamic response of the unit shaft system, and the loads effect on the rotor system is summarized from the vibration source system which are time-invariant. In these discussion, the loads are changed with many factors except time. For the reason mentioned above, it is necessary to carry out the research for the dynamic characteristic of rotor-bearing system coupled with the hydraulic system, mechanical system and electric system.

In this paper, a nonlinear copuled model of hydropower plant is development to study the structure's/rotor system dynamic characteristics during the coupeld transients process which are resulted in start-up laws. First, a elastic penstock model is established on the basis of the continuity and momentum equations describing the general behaviours of fluids in a pressure duct in terms of two variables, namely, H , piezometric head, and Q , fluid flow. A PID control strategy is used to model the governor system for hydro-turbine, which represented as a third order differential equation in mathematic. A third order model of synchronous generator which is depicted by three differential equations is employed. Then, a simultaneously differential equations with above sub-system equations were established for coupled system. Finally, a FEM model of classical rotor-bearing system is developed.

Q_i -discharge in penstock at the node i
 H_i -pizeometric head in penstock at the node i
 H_n -net water head of turbine
 D, A -the cross section diameter and area of penstock
 D_1 -the diameter of hydro-turbine
 H_{np} -the operating head of hydro-turbine
 Q_p, Q_1' -hydroturbine's discharge and unit discharge
 a -water hammer wave velocity
the superscript * represent the per-unit parameters
 n, n_1' -hydroturbine's mechanical speed and unit speed
 P_t, P_1' -power and unit power of hydroturbine
 ω_m, ω_e -mechanical speed and electrical speed
 θ_m, θ_e -mechanical/electrical rotation angle
 ω_{ms}, ω_{es} -mechanical/electrical synchronous speed
 f_m, f_e -mechanical/electrical frenquency
 f_{ms}, f_{es} -mechanical/electrical synchronous frenquency
 P_t, P_e - mechanical/electrical power (active output)
 $P_c, \Delta P_e$ -certain/incremental generator ouput
 τ -gate opening
 η -turbine efficiency
 b_p -permanent droop

b_t -temporary droop
 T_d -reset time or dashpot constant
 T_n -governor time constant
 T_m turbine inertia time constant
 T_w -water inertia time constant
 T_y -main servo time constant
 T_{yB} -pilot valve and servo motor time constant
 $y_{d1}, \Delta y, y_0$ - turbine servomotor stroke and its deviation value, its initial value]
 J -inertia moment of the unit in direction of rotation (kg m²)
 K_p, K_i, K_d -proportional, integral, derivative governor gain
 R_a, R_r -radius of shaft and rotor
 R_b -journal radius
 R_i, R_o -radius of inner ring and outer ring for pad
 L_p, L_r -height of pad, rotor length
 p -oil pressure
 e_b, e_r -eccentricity of shaft axis, rotor centre
 c_b, c_r -clearance of bearing, rotor (air-gap length)
 h -thickness of oil film
 δ_p -swing angle of pad
 α_p -opening angle of pad
 η_r -angle between the calculation location and y axis
 β -angle between a point of support for pad and y axis
 θ_b -bearing axis deviation angle
 K_{ij}, C_{ij} -stifness, damping coefficients, $i=x, y; j=x, y$
 M_t, M_e -mechanical torque and electromechanical torque
 I_f, U_f -field excitation current and voltage

1. MODEL

A complex and coupled whole nonlinear system for hydropower plant is established as illustrated in Fig.1. In order to develop the mathematical model, the system is decoupled into several modules and then dynamic nonlinear model is developed for each module. A new discussion can be carried out for the dynamic characteristics of the generator unit an palnt structure by using this numerical model.

1.1 Penstock Model

The the pressure conduit on the upstream of the plant is the connection between the hydro-turbine and reservoirs. The transition flow of the penstock can be described as Momentum Equation and Continuity Equation, as shown in Eq.(1)-(2),

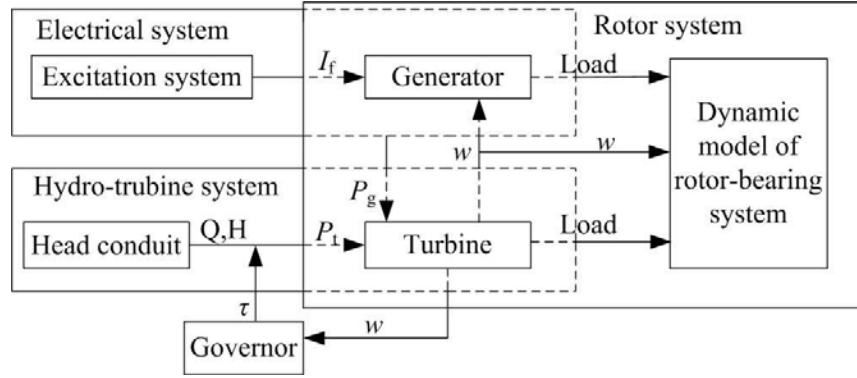

Figure 1. Sketch of Hydropower Plant System

$$\frac{\partial Q}{\partial t} + \frac{Q}{A} \frac{\partial Q}{\partial x} + gA \frac{\partial H}{\partial x} + \frac{fQ|Q|}{2DA} = 0 \quad (1)$$

$$J \frac{d\omega_m}{dt} = J \frac{d^2\theta_m}{dt^2} = M_t - M_e \quad (8)$$

$$\frac{\partial H}{\partial t} + \frac{Q}{A} \frac{\partial H}{\partial x} + \frac{a^2}{Ag} \frac{\partial Q}{\partial x} + \frac{Q}{A} \sin \alpha = 0 \quad (2)$$

and, a Explicit Finite Diffenretial Method (EFDM) is applied to disvretize the Eq.(1) and Eq.(2) at the junction nodes,as

$$Q_i^{n+1} = \frac{1}{2}(Q_{i+1}^n + Q_{i-1}^n) - \frac{\Delta t Q_i^n}{2A\Delta x}(Q_{i+1}^n - Q_{i-1}^n) - \frac{\Delta t g}{2\Delta x}(H_{i+1}^n - H_{i-1}^n) - \frac{f}{8DA}(Q_{i+1}^n + Q_{i-1}^n)(Q_{i+1}^n + Q_{i-1}^n) \quad (3)$$

$$H_i^{n+1} = \frac{1}{2}(H_{i+1}^n + H_{i-1}^n) - \frac{\Delta t Q_i^n}{2A\Delta x}(H_{i+1}^n - H_{i-1}^n) - \frac{\Delta t}{2A\Delta x} \frac{a^2}{g}(Q_{i+1}^n - Q_{i-1}^n) - \frac{\Delta t}{A} Q_i^n \sin \alpha \quad (4)$$

respectively, the subscripts i and superscripts n denote the position node i and time node n .

The hydro-turbine model consist of the relationship between H , Q , τ and n . It is the downstream boundary condition for penstock, the positive characteristic equation at time n is,

$$Q_p = C_p A - C_a A H_p \quad (5)$$

Where,

$$C_a = g/a \quad (6)$$

$$C_p = \frac{Q_M}{A} - \frac{\Delta t}{A^2 \Delta x} (Q_M + A a_M)(Q_M - Q_L) +$$

$$C_a [H_M - \frac{\Delta t}{A \Delta x} (Q_M + A a_M)(H_M - H_L)] + g(S_0 - S_f) \Delta t \quad (7)$$

The subscripts M and L denote the last two position nodes as shown in Fig.2.

1.2 Hydro-turbine model

The Hydro-turbine converts the hydraulic power to the mechanical power which can supply the motivity to drive (as M_t shown in Eq.(8)) the shaft of rotor system,the rotation equation is,

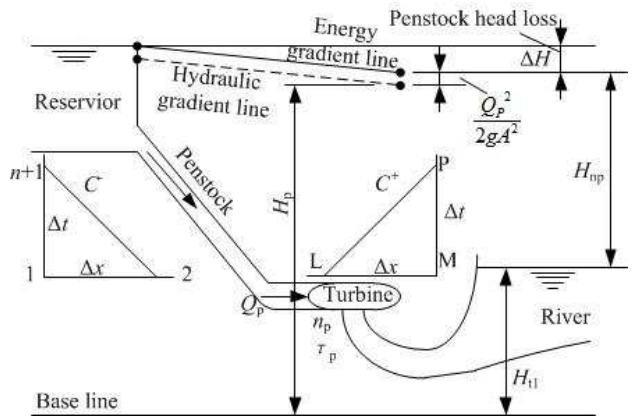

Figure 2. Boundary Condition

The synthetic characteristic curves are applied into the numerical calculation which could consider the nonlinear variation sufficient during the transient process. The datas of the curves for whole operations can be obtained by fitting and interplation.

$$\tau = f(n_1', Q_1') \quad (9)$$

$$\eta = g(n_1', Q_1') \quad (10)$$

Eq.(9) to Eq.(10) express the nonlinear relationship of the synthetic characteristic curves, which reflect the turbine's dynamic behaviors. With combining the H_p , Q_p which are solved from the penstock model as shown in Eq.(3)~Eq.(5), the Eq.(9) and Eq.(10) and the law of hydraulic similitude, we can calculation the n , H_n , Q_p and M_t for hydro-turbine at any operation point.

1.3 Governor model

The hydraulic governor system provide a reliable rotate speed regualtion of turbine with load variation in the power system. In this paper, a classical PID control strategy is applied in the coupled system on the basis of the predecessors' studies.

As shown in Fig.3, the C_f is ferenquency command. The transfer function from x to y in Fig.3 can be written as,

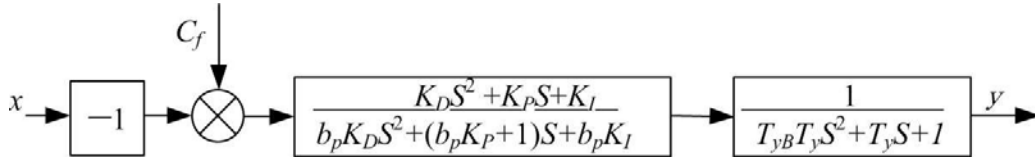

Figure 3. The Transfer Function of the Frequency Regulation Mode

$$G(s) = \frac{Y(s)}{X(s)} = \frac{K_D S^2 + K_P S + K_I}{b_p K_D S^2 + (b_p K_P + 1)S + b_p K_I} \frac{1}{T_{yB} T_y S^2 + T_y S + 1} \quad (11)$$

Where x is the input variable and y is the output variable. A third order differential equation can be derived from Eq.(11) by the Inverse Laplace Transformation, as

$$b_p K_D T_y^* y''' + (b_p K_P T_y^* + T_y^* + b_p K_D) y'' + (b_p K_I T_y^* + b_p K_P + 1) y' + b_p K_I y = K_D x'' + K_P x' + K_I x \quad (12)$$

Further, a equation of state is obtained from Eq.(12) according to the Modern Control System [09], which is a first-order differential equations. The y can be sloved from the equations by Multistage Runge-Kutta algorithm. The gate opening can be obtained finally.

1.4 Rotor_bearing model

A FEM model of rotor system is established in this paper by Ansys, which is a mature software for FEM methods. The beam188 element is employed to simulate the shaft of the rotor system. The rotor and the turbine are simplified as mass21 element in the model. The combine14 element is used into simulate the guide bearings, and the dynamic characteristics of the bearings are equivalent to the coefficients of stiffness and damping (k_{ij}, c_{ij}) of the element parameters. The rotor system model is mounted on a FEM model of powerhouse, as shown in Fig.4.

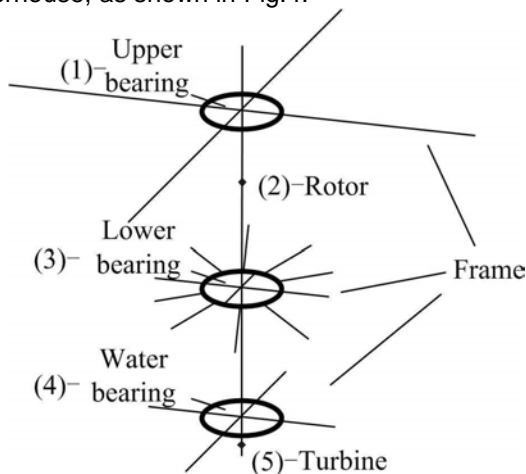

Figure 4. Rotor-bearing model

A tilting pad guide bearing model is used in rotor system. The Reynolds Equation is used to describe dynamic oil film pressure fields around the pads in

radial direction when the rotate speed value of the turbine is small.

$$\frac{\partial}{\partial x} \frac{h^3}{\mu} \frac{\partial p}{\partial x} + \frac{\partial}{\partial z} \frac{h^3}{\mu} \frac{\partial p}{\partial y} = 6U \frac{\partial h}{\partial x} \quad (13)$$

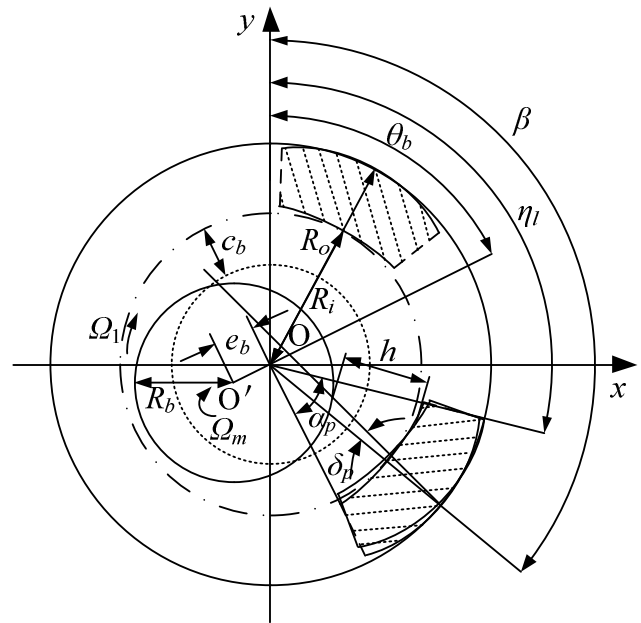

Figure 5. Tilting pad guide bearing

p is the pressure of oil film. The equation in nondimension can be written as

$$\frac{\partial \bar{h}}{\partial \eta_l} \bar{h}^3 \frac{\partial \bar{p}}{\partial \eta_l} + \gamma^2 \bar{h}^3 \frac{\partial \bar{p}}{\partial \lambda} = 6 \frac{\partial \bar{h}}{\partial \eta_l} \quad (14)$$

$x = R\eta_l, \lambda = y/(L_b/2), \lambda \in [-1, +1]$, the non-dimension parameters for the thickness of oil film is,

$$\bar{h} = 1 + \varepsilon \cos(\eta_l - \theta_p) - (1 - c'/c_b) \cos(\beta - \eta_l) + \delta_p / b \sin(\beta - \eta_l) \quad (15)$$

Where, $\varepsilon = e_b/c_b$, is eccentricity of the guide bearing, the $b = c_b/R_b$, is the ratio of clearance and radius. If the u and v is the circumferential velocity and radia velocity speed of the oil film, the Dynamic Reynolds Equation can be expressed as,

$$\frac{\partial \bar{h}}{\partial \eta_l} \bar{h}^3 \frac{\partial \bar{p}}{\partial \eta_l} + \gamma^2 \bar{h}^3 \frac{\partial \bar{p}}{\partial \lambda} = 6 \frac{\partial \bar{h}}{\partial \eta_l} + 6(u \sin \eta_l + v \cos \eta_l) \quad (16)$$

Where, $a = \frac{3}{4} \frac{\partial \bar{h}}{\partial \eta_l} / \bar{h} + \frac{2}{\bar{h}} \frac{\partial^2 \bar{h}}{\partial \eta_l^2}$

The oil pressure can be obtained from Eq.(16) by FEM method, then the loads of the oil film can be generated through the iteration of element solution [21]. The loads' partial derivatives respect to the displacement and velocity are ($i, s = x, y$),

$$K_{is} = \frac{\partial f_i}{\partial s}, C_{is} = \frac{\partial f_i}{\partial \dot{s}} \quad (17)$$

Which is the coefficients of the stiffness and damping for each pad. Then, the total coefficients (k_j, c_j) of the bearing can be generated by combining the coefficients of pads[11].

2. Methods

The process of electro-magnetic transient is not involved in the process of start-up, except the change of the field current during the process of voltage build up in the no-load operation, so, in this paper, the electrical system model is not taken into account.

The rotor-bearing FEM model is built by Ansys, and other models are compiled in Fortran. With the UPFs of the Ansys, the programs of Fortran can be compiled into some commands from users, then, the operation process of hydro-turbine and generator's rotor can be simulated by the dynamic time-history analysis method with Ansys. On this basis, dynamic characteristics of the rotor system can be studied at any process during the operation of hydropower station.

The type of turbine is named HL180-LJ-410 in this paper, which is complied with the China's naming code. Its means that a francis turbine with runner type of 180, vertical arrangement, metallic spiral casing, and the diameters of runner is 410mm.

The mechanical eccentric forces of rotators and the unbalanced magnetic pull of rotor are considered for the kinetic rotor-bearing system[22].

3. Result analysis

The datas of the whole model are listed in the Tab.1.

During the process of start-up, the speed rised up smoothly with good dynamic response, short response time, small overshoot and fast attenuation. The gate

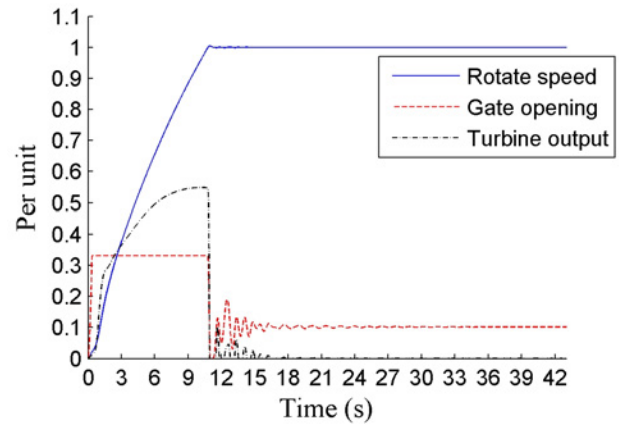

Figure 6. Simulation result of start-up transient

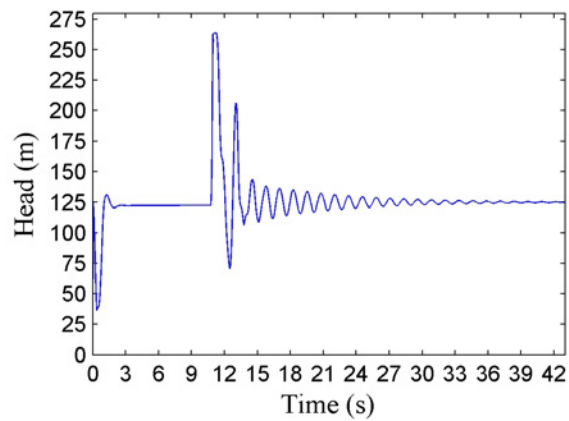

Figure 7. The head change during start-up

opening fast reached the start opening at first, when the speed arrived at the rated point, the opening begins to attenuate with fluctuation with fluctuation until it stability at no-load opening. At the same time, in order to supply the power for growing speed, the turbine output increased rapidly. When the speed is stable, the output is reduced to 0 with a short fluctuation process.

When the gate is quickly opened at first, the head decreased and the flow increased quickly for the hydro-turbine. Near the 12 seconds, the flow suddenly arrived

Table 1. Datas of models

Nominal/no load value of Turbine					Length/diameter of penstock (m)				
Head(m)	Weight (t)	Discharge(m ³ /s)	Power(kVA)	Speed(r/min)					
117/124.9	420	86.65/14.7	88*	150*	495/8.5				
Time constants of governorn start-up (s)									
T_m	T_w	T_d	T_n	b_p	b_t	T_y			
9	1.10	4 T_w	0.5 T_w	0.01	2(T_w/T_m)		0.1		
Parameter value of rotor-bearing system (m)									
R_a	R_b	R_r	R_i	R_o	L_p	L_r	c_b	c_r	
0.9	2.12	5	2.12036	2.185	0.587	2.5	0.36E-3	16E-3	
Nominal/no load value of excitor and Generator									
$I_f(A)$		$I(kA)$		$U(kV)$		$\cos\phi$		$U_{SN}(KV)$	Weight (t)
1300/850*		4.22*		13.8		0.91		12.05*	91

The ‘*’ represent the basic value of the per unit

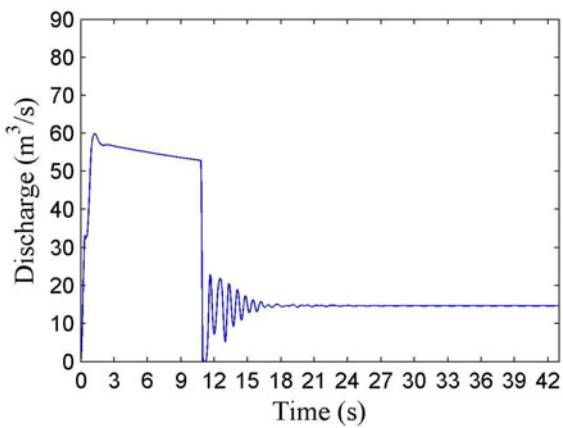

Figure 8. The discharge change during start-up

at $0\text{m}^3/\text{s}$ because of the closed gate, it caused a high head for the turbine, this phenomenon may create a great impulse pressure on the spiral case.

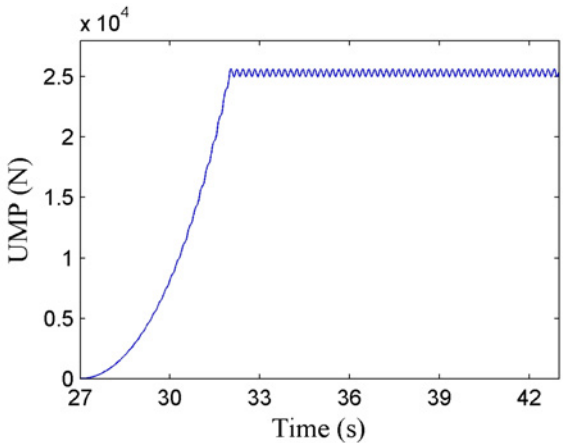

Figure 9. The change of UMP

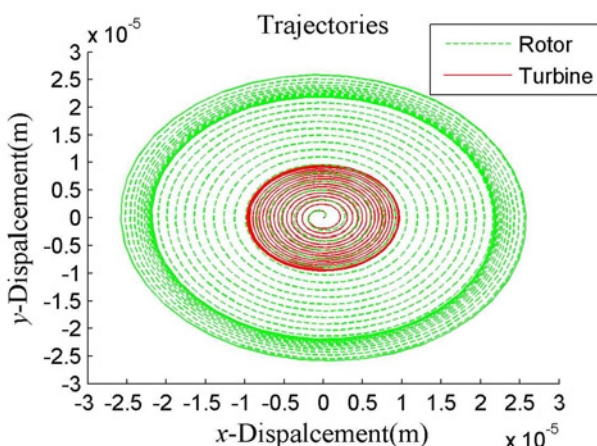

Figure 10. The trajectories of rotators

As the fig.10 shown, the displacements of rotor and turbine are growing with the rotate speed. The trajectories are stable when the rotate speed at the rated point. When the process of voltage build up is started, the field current is increased. The rotor displacement is growing because of UMP's increasing as shown in Fig.9, and with the UMP is balanced in fluctuation which is because the value of UMP is

concerned with the rotor's displacement, the rotor's trajectories achieved a new stability again. As shown in Fig.11, the axis trajectories' change of upper and lower guide bearings are similar to the rotor's because they provide the directly supporting to the rotor.

Comparing Fig.10 and Fig.7 & 8, the vibration of rotor system has no influence on the hydraulic transient, because the head and discharge of turbine are stable when the rotor's displacement increased with the UMP.

Under the condition of this paper, the hydraulic force has not taken into consideration for the rotor system movement yet, but the hydraulic transient show its great influence on it. The generator power is zero during the process, so, when the turbine output is increased, the torque for the turbine is increased too, then the eccentric forces become larger with the higher rotate speed, finally, the rotor system vibrate with its rotation.

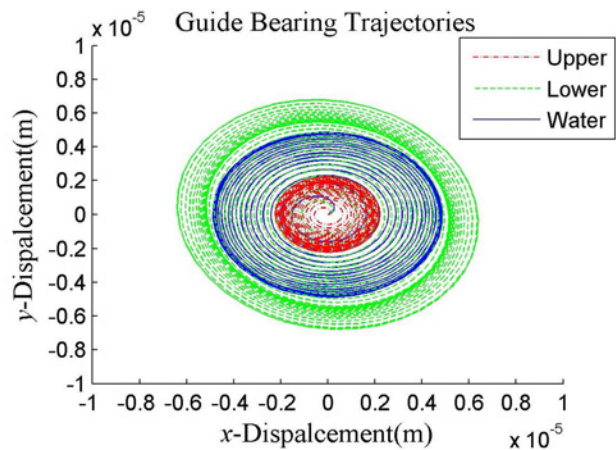

Figure 11. The trajectories of guide bearings' axis

4. Conclusions

In this paper, a whole model of the hydraulic power system was established. The model is used to studying the dynamic characteristics of rotor system when the coupled hydraulic-mechanical-electric factors is considered. The rotor-bearing system is the most important component in the model, meanwhile, the hydraulic, mechanical and electrical subsystems' are built and coupled together. The model is based on reliable mathematic and physical theories, and it gives a good simulation of the process of start-up as shown above.

On the basis of simulation, the results indicate that the hydraulic transient influence the rotor system 's rotation, it reflects the inner connection between the subsystems.

In the future, the hdyraulic forces on the trubine and the impluse pressure on volute will be considered, a detial generator model will be coupled into the whole model, then, the more process of station operation can be simulated to study on the dynamic characteristics of rotor system.

ACKNOWLEDGMENTS

This research is supported by the National Natural Science Foundation of China (No.51379030).

REFERENCES

- [1] Hovey LM. Optimum adjustment of hydro governors on Manitoba hydro system. AIEE Trans Power Apparatus and Systems, 81:581–587,1962.
- [2] L.WOZNIAK and G.H.FETT. Conduit representation in closed loop simulation of hydroelectric system, Basic Eng, 94 (3), 599-604, 1971.
- [3] Sanathanan CK. Accurate low order model for hydraulic turbine-penstock. IEEE Trans on Energy Conversion 2:196–200,1987
- [4] Nand Kishor, R.P.Saini and S.P.Singh. Simulation of reduce order hydro turbine models to study hydraulic transient charactersitic. 9th international Multitopic Conference , 1-6, 2005.
- [5] Vournas CD. Second order hydraulic turbine models for multimachine stability studies. IEEE Trans on Energy Conversion, 5:239–244,1990
- [6] IEEE Committee. Dynamic models for steam and hydro turbines in power system studies. IEEE Trans on Power Appar Syst, 92:1904–1915,1973
- [7] IEEE Working Group. Hydraulic turbine and turbine control models for system dynamic studies. IEEE Trans on Power Syst, 7:167–179,1992
- [8] Paynter HM. A palimpsest on the electronic analog art. A. Philbrick Researches, Inc. Boston:Mass;1955.
- [9] Leum M. The development and field excitation of a transistor electric governor for hydro turbines. IEEE Trans Power Appar Syst. \85:750–756,1966
- [10] Chaudhry MH. Governing stability of a hydroelectric power plant. Water Power,131–136,1970
- [11] Agnew PW. The governing of Francis turbines. Water Power,119–126,1974
- [12] Findlay D, Davie H, Foord TR, Marshall AG, Winning DJ. Microprocessor based adaptive water turbine governor. Inst Elect Engg C. 127:360–369,1980
- [13] Kopacek P, Zauner E. Governing turbines by microcomputer. Int Water Power Dam Constr 34, 26–30,1982
- [14] Murthy MSR, Hariharan MV. Analysis and improvement of the stability of a hydro turbine generating unit with long penstock. IEEE Trans Power Appar Syst. 360-267, 1983
- [15] Luqing YE, Shouping WEI, Haibo XU, Malik OP, Hope GS. Variable structure and the time-varying parameter control for hydroelectric generating unit. IEEE Trans Energy Conv. 4:293–299,1989
- [16] Malik OP, Hope GS, Luqing YE, Shouping WEI, Haibo XU. An intelligent self-improving control strategy with a variable structure and time-varying parameters for water turbine. Reveu General de l'Electricite. 4:23–35,1989
- [17] Herron J, Wozniak L. A state space pressure and speed sensing governor for hydro generators. IEEE Trans Energy Conv. 6:414–418,1991
- [18] Arnautovic DB, Skataric DM. Sub optimal design of hydro turbine governors. IEEE Trans Energy Conv, 6:438–44,1991
- [19] Luqing YE, Shouping WEI,et. An intelligent self-improving control strategy and its microprocessor-based implementation to a hydro-turbine governing system. Can J Elect Comp Eng, 15:130–138,1990
- [20] Xueli An,Jianzhong zhou et al. Dynamic response of a rub-impact rotor system under axial thrust. Arch Appl Mech, 79 :1009-1018,2009
- [21] Ma Zhen-yue,Dong Yu-xin. Dynamic Coefficients of Tilting Pad Guide Bearings of Hydraulic Turbine set. Power Engineering,10(6) :6-11,1990
- [22] Guo D, Chu F, Chen D. The unbalanced magnetic pull and its effects on vibration in a three-phase generator with eccentric rotor. Journal of Sound and Vibration,Vol.254,Issues2,297-312,2002.