



HAL
open science

Prevention Methods of Self-excited Vibration due to Dry Friction of Vertical Rotor

Yusuke Watanabe, Masaji Ishii

► **To cite this version:**

Yusuke Watanabe, Masaji Ishii. Prevention Methods of Self-excited Vibration due to Dry Friction of Vertical Rotor. 16th International Symposium on Transport Phenomena and Dynamics of Rotating Machinery, Apr 2016, Honolulu, United States. hal-01890062

HAL Id: hal-01890062

<https://hal.science/hal-01890062v1>

Submitted on 8 Oct 2018

HAL is a multi-disciplinary open access archive for the deposit and dissemination of scientific research documents, whether they are published or not. The documents may come from teaching and research institutions in France or abroad, or from public or private research centers.

L'archive ouverte pluridisciplinaire **HAL**, est destinée au dépôt et à la diffusion de documents scientifiques de niveau recherche, publiés ou non, émanant des établissements d'enseignement et de recherche français ou étrangers, des laboratoires publics ou privés.

Prevention Methods of Self-excited Vibration due to Dry Friction of Vertical Rotor

Yusuke Watanabe^{1*}, Masaji Ishii¹



Abstract

Recently, because of performance upgrades of rotating machinery, the clearance between rotating parts (Rotor) and stationary parts (Stator) has become very small. Therefore, vibration problems by the contact of rotor and stator often occur. In addition, with some types of rotating machinery, the sliding bearing without liquid lubrication is also used. In such condition, the rotor and the stator always come in contact at bearing sliding surface. So, if the contact condition of rotor and stator is severe (such as friction coefficient of sliding surface is high etc.), various vibration problems may occur. One of the typical vibration problem by friction is self-excited vibration due to dry friction (often called “Friction Whip”). Usually, this type of vibration is prevented by low friction coefficient of sliding surfaces. However, if we can accept high friction coefficient of bearing sliding surfaces, we may use more high performance bearing materials (wear resistance, strength, chemical, durability, material cost, etc.). In this paper, it is investigated that the characteristics and the prevention methods of self-excited vibration due to dry friction between rotor and stator by experimentally approach.

Keywords

Contact — Friction — Self-excited Vibration

¹EBARA CORP. Kanagawa, JAPAN

*Corresponding author: watanabe.yusuke@ebara.com

1. INTRODUCTION

Recently, because of performance upgrades of rotating machinery, the clearance between rotating parts (Rotor) and stationary parts (Stator) has become very small. Therefore, vibration problems by the contact of rotor and stator often occur. In addition, with some types of rotating machinery, the sliding bearing without liquid lubrication is also used. (For example, the periodic operation check of the drainage pumps on dry-season.) In such condition, the rotor and the stator always come in contact at bearing sliding surface. So, if the contact condition of rotor and stator is severe (such as friction coefficient of sliding surface is high etc.), various vibration problems may occur.

One of the typical vibration problem by friction is self-excited vibration due to dry friction (often called “Friction Whip”). Usually, this type of vibration is prevented by low friction coefficient of sliding surfaces. However, if we can accept high friction coefficient of bearing sliding surfaces, we may use more high performance bearing materials (wear resistance, strength, chemical, durability, material cost, etc.).

In this paper, it is investigated that the characteristics and the prevention methods of self-excited vibration due to dry friction between rotor and stator by

experimentally approach.

2. FRICTION WHIP

Figure 1 shows the rotating part in contact with the stationary part. When the rotor in rotation comes into contact with the stationary part, a friction force in the circumferential direction is produced between surfaces in contact, which causes whirling in the direction opposite to the rotation (Backward Whirling). When the effect causing this whirling (destabilizing effect) is larger than the damping effect of the system (stabilizing effect), negative damping that causes self-excited vibration is produced.

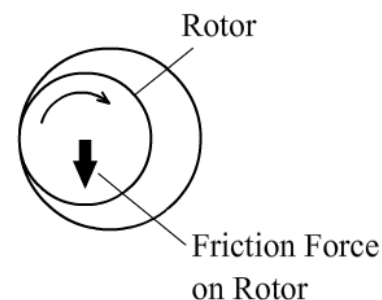

Fig.1 Contact of Rotor and Stator

The vibration occurs in such a way that the rotor rolls on the inner surface of the stationary part; the whirling

frequency under the assumption that there is no sliding motion on the sliding surfaces can be expressed as in Equation 1.

$$\frac{R}{Cr} \Omega = \omega \dots(1)$$

where, R : radius of rotor, Cr : radial clearance,
 Ω : rotating angular velocity, ω : whirling angular velocity.

In this case, if the clearance between the rotor and the stationary part is narrow, the whirling frequency will be extremely high; however, in practice, the whirling frequency cannot exceed the natural frequency of the rotor (although it depends on the amount of energy to be input), and the rotor whirls at the natural frequency of the rotor with slip at sliding surfaces. Such vibration is called “Friction Whip”.

By the friction between the sliding surfaces, this vibration efficiently converts the rotational energy of the rotor into whirling motion. This type of self-excited vibration sometimes becomes so severe that it may cause damage to machinery; therefore, this phenomenon has long been seen as a problem that requires extra care [1] and studied under various conditions to date [2-8].

3. TEST RIG

Figure 2 shows a schematic view of the test rig. For simplification, the rotor system was configured to have a vertical shaft supported by two bearings, the upper ball bearing and the lower unlubricated sliding bearing, and a relatively large rotating mass between the bearings. The rotational speed of the rotor was increased by a variable speed induction motor from the stop state to a rated speed (the rated speed and the acceleration time were variable), and the system was operated at a fixed speed once the rotational speed reached the rated speed. The rotational speed, shaft vibration behaviors (in two orthogonal directions), and the shaft torque and temperature of sliding bearing were measured by sensors to observe behaviors while “friction whip” was occurring. An unlubricated cylindrical sliding bearing made of resin was used for the sliding portion in contact, the friction of which caused “friction whip”. The test used a resin bearing and a shaft sleeve made of cemented carbide with the friction coefficient between their sliding surfaces being around 0.2 to 0.25. Table 1 shows the dimensions and typical properties of the test rig. The rotor system has the natural frequency of the first bending mode around 22 Hz, In this test, rotating

speed of the rotor was under the natural frequency of it. And the housing has the natural frequency of about 44 Hz, sufficiently higher than that of the rotor. The purpose of the test was to observe “friction whip” phenomenon and to examine means to prevention of it. For this purpose, the test rig was configured to have low damping so as to create conditions under which negative damping (which makes self-excited vibration) was easily caused by friction even when sliding materials with a low friction coefficient were used.

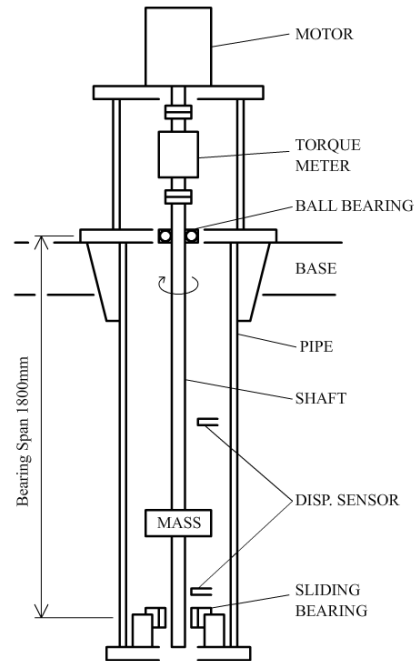

Fig.2 Test Rig

Table.1 Configuration of Test Rig

ROTATING PARTS	
SHAFT DIA.	52mm
BRG SPAN	1800mm
ROTATING MASS	30Kg
NATURAL FREQ.	22Hz
SLIDING BRG	
MATERIAL	Resin
INNER DIA.	65mm
RADIAL CLEARANCE	0.1mm
FRICITION COEF.	0.2~0.25
MOTOR	
TYPE	INDUCTION MOTOR with INVERTOR
POWER	7.5kW
MAX SPEED	1500rpm(25cps)

4. RESULT (EXAMPLE OF FRICTION WHIP)

Figure 3 shows an example of “friction whip” occurred in the test rig. Time waveforms in the upper section indicate the rotational speed, the temperature around the sliding portion of the bearing, and the temperature of the bearing housing, a time waveform in the middle section indicates the shaft torque, and time waveforms in the lower section indicate the vibration amplitude at the middle of the shaft (in two orthogonal directions) and the vibration amplitude of the stationary part. The three figures in the lowest section show the orbits of the shaft before the occurrence of “friction whip”, immediately after the occurrence, and before the disappearance of it, respectively. “Friction whip” occurred at a relatively low rotational speed immediately after the startup, and as mentioned above, its frequency was the natural frequency of the first bending mode of the rotor (about 20~22Hz) and doesn't depend on rotating speed of

the rotor, and the whirling direction was opposite to the rotational direction (backward whirling). The magnitude of this vibration energy can be deduced from the fact that the vibration amplitude of the shaft was very large. This vibration did not disappear even when the rotational speed of the rotor increased; however, the vibration amplitude and the shaft torque decreased over time after the rotational speed had reached the rated speed. This is attributable to gradual reduction in the friction coefficient of the resin material as the temperature of the sliding portion of the bearing increased; as a result, “friction whip” disappeared when the destabilizing effect of friction became smaller than the damping effect of the system (around 972 seconds in Fig. b). After the disappearance of “friction whip”, the shaft vibration amplitude became very small, and the temperature of the sliding portion of the bearing started to drop toward thermal equilibrium under normal sliding conditions.

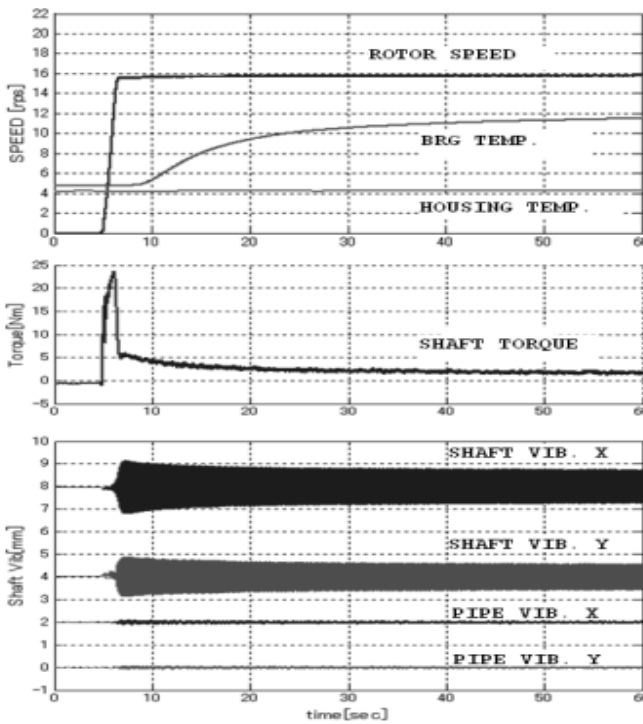

a) Time wave (~60sec)

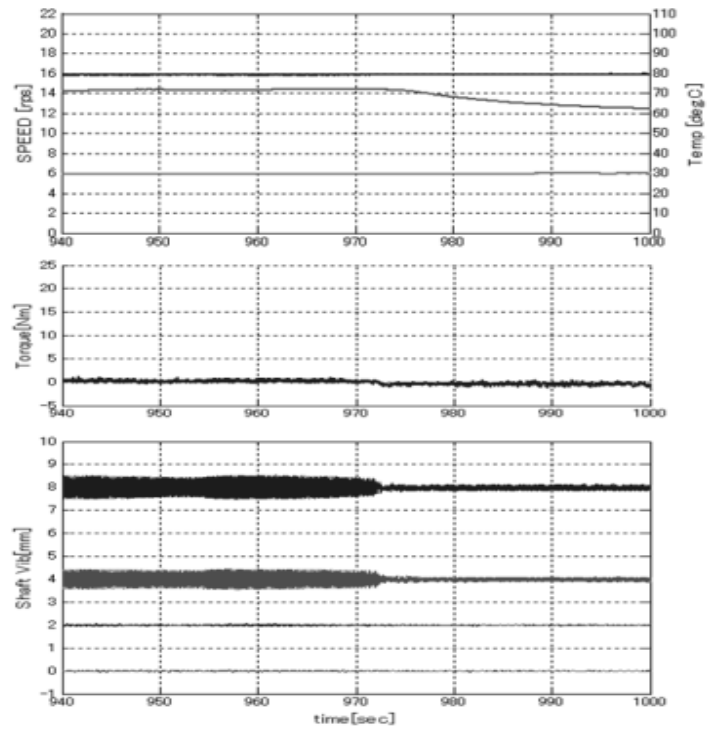

b) Time wave (after 15min)

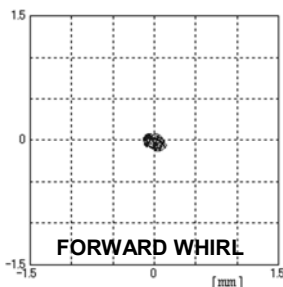

c) Shaft Orbit (w/o Friction whip)

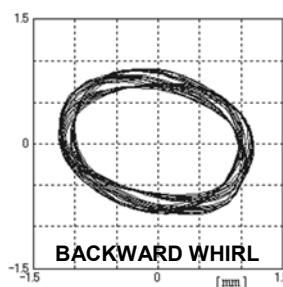

d) Shaft Orbit (Friction Whip occur)

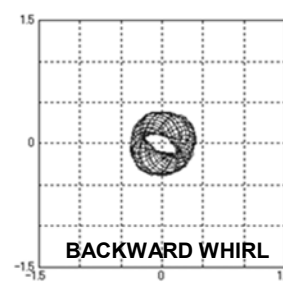

e) Shaft Orbit (after 15min)

Fig.3 An Example of Friction Whip

5. PREVENTION METHODS

Next, some typical and empirical prevention methods of the “friction whip” are outlined below. And finally, a new efficient prevention method (this is main object of this paper) is shown in this chapter.

-1) Lowering friction coefficient

The most effective means to prevent “friction whip” is lowering the friction coefficient between sliding surfaces. A low friction coefficient can prevent and reduce the magnitude of vibration even if “friction whip” occurs. Figure 4 shows the shaft vibration amplitude when the friction coefficient between the sliding surfaces was lowered by adding a trace amount of water (only a few droplets so as not to produce fluid film covering the entire bearing as in a bearing with fluid lubrication) while “friction whip” was occurring. The figure clearly shows that “friction whip” disappeared at the moment water was added. “Friction whip” occurred again when water was lost from the sliding surfaces, suggesting that the occurrence of “friction whip” is extremely susceptible to the friction coefficient between the sliding surfaces.

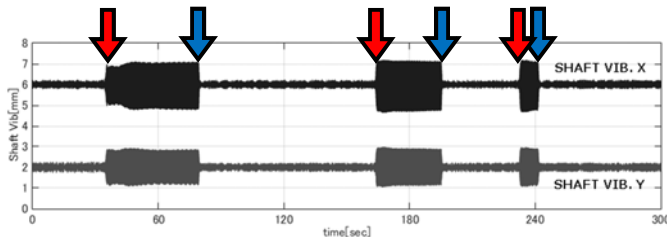

Fig.4 An Example of Low Friction Behavior
(with minuscule droplet of water)

Red Arrows: Friction Whip Occur

Blue Arrows: Add Water

-2) Adding damping

Adding damping is a common method for reducing most types of self-excited vibration, however, because it is difficult to have large damping under unlubricated conditions, various measures should be taken. It is important that not only the bearing system has a large damping by using appropriate sliding materials and its support structure, but also the entire system has a large damping capacity. The following shows the relationship between the friction coefficient / bearing damping of the bearing and the occurrence of “friction whip”. (See APPENDIX)

$$\frac{\mu \cdot K_b}{\omega_n C_b} > 1 : \text{Unstable} \quad \dots(2)$$

where, μ : Friction coefficient,
 K_b : bearing spring constant,

C_b : bearing damping coefficient

ω_n : angular natural frequency of rotor

It is desirable that the bearing system is stabilized in the above equation. However, in practice, “friction whip” does not occur as long as the rotor and the stationary parts have a positive damping ratio of the lower natural frequency of the rotor. Therefore, it is also important to secure a positive damping ratio by considering a design of the structure of the entire system (not only rotor but also stationary parts) sufficiently.

-3) Increasing natural frequency

Increasing the natural frequencies of the rotor is another effective and common measure to reduce self-excited vibration. Usually, the frequency of self-excited vibration is the natural frequency of the rotor; so, higher natural frequency requires larger energy input (in other word, an efficient mechanism to convert driving torque into vibration energy, such as high friction coefficient) to generate and maintain “friction whip”. From Equation 2 described earlier, a high natural frequency improves the stability.

In above consideration, an important thing is the natural frequencies of the rotor should be taken not to design at the integral multiples of the rotational speed. If the natural frequency of rotor exists at the integral multiples of the rotational speed, the vibration behavior of rotor shows large and complicated orbit, because of resonance of higher harmonics. Then such behavior of rotor tends to be a trigger of the backward motion of the “friction whip”.

-4) Adding unbalance of rotor

In our experience, when unbalance in the rotor is large efficiently, “friction whip” hardly occurs. It is considered that the stability increases as the natural frequency of the system increases with the shaft constantly pressed firmly into the bearing (increase bearing stiffness), and friction coefficient of sliding surface decreases by large contact pressure in resin materials. However, care should be taken that large unbalance itself causes vibration.

-5) FRICTION CANCELLER SYSTEM

The purpose of all measures to prevent “friction whip” discussed so far in this study is to have a destabilizing effect of friction coefficient between the sliding surfaces smaller than the stabilizing effect of damping in the system. This requires the maintenance of an extremely low friction coefficient, which prevents the use of materials with superior properties other than

the friction coefficient, such as wear resistance, durability, and chemical resistance. To overcome this problem, we have developed the friction canceller system shown below [9] as a means to prevent “friction whip” even when the friction coefficient between the sliding surfaces is high. As shown in fig. 5, the friction canceller system uses a pair of bearings: one normal unlubricated sliding bearing (bearing A) and the other unlubricated sliding bearing (bearing B) that has the outer rotating side and the inner stationary side opposing to those of the normal bearing. In this way, the destabilizing effect can be cancelled because the directions of the friction force on the shaft at the sliding portion of the bearing A and bearing B oppose each other as shown in fig. 5. Unlike conventional measures to reduce a friction force, this friction canceller system, which counteracts a friction force, can effectively reduce “friction whip” even when the friction coefficient of a bearing material is high. Figure 6 shows the results of a test in which the friction canceller system was used at the lower end of the shaft. In these tests, acceleration of the rotor was set different from fig.3 to observe the effect of rotating speed. Comparing with the results of a test under the same conditions but without using the friction canceller system, where “friction whip” occurred, the effect of the friction canceller system is distinctive.

Because this system can also be used under fluid-lubricated conditions and cancel, on the same principle, a destabilizing force on forward whirling caused by fluid film, the maximum potential of this system can be achieved when used for rotating machinery that operates under both un-lubricated and fluid-lubricated conditions.

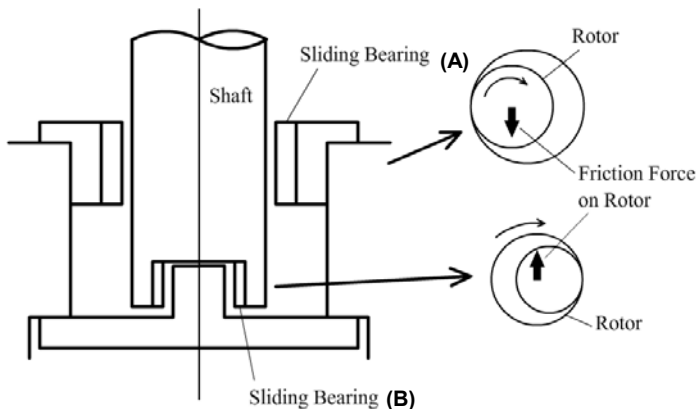

Fig.5 Mechanism of Friction Canceller

6. CONCLUSION

We reproduced self-excited vibration phenomena caused by friction (“friction whip”), which may occur in a vertical shaft rotating body involving sliding between the rotating part and the stationary part, to examine details and characteristics of the behaviors of the phenomena. While several methods for preventing “friction whip” are discussed in this paper, we have developed the friction canceller system, which can effectively reduce “friction whip” even when a sliding portion has a high friction coefficient, and examined its effect. The results of the test have led us to conclude that the developed technology can contribute significantly to the reliable and safe operation of rotating machine products that involve friction and sliding.

REFERENCES

1. S.Timoshenko, Vibration Problems in Engineering (3rd) (1955)
2. Yanabe,S., et al., Whirling of a Vertical Rotor Contacting with Annular Guard during Acceleration by a Power Limited Motor., Transaction of the Japan Society of Mechanical Engineers, Series C (in Japanese), 64-622(1998), 1890-1895.
3. Yanabe,S., et al., Whirling of a Vertical Rotor Contacting with Annular Guard during Acceleration by a Power Limited Motor. 2nd Report. Patterns of Rotor Whirling Motion and Balance of Forces., Transaction of the Japan Society of Mechanical Engineers, Series C (in Japanese), 65-634 (1999), 2211-2217.
4. Watanabe,Y., et.al., Study of Self-Excited Vibration of Rotor and Casing due to Dry Friction, Proceedings of the 11th International Symposium on Transport Phenomena and Dynamics of Rotating Machinery, (ISROMAC-11 2006), ID130,
5. A.Lingener, Experimental Investigation of Reverse Whirl of Flexible Rotor, Proceedings of 3rd International Conference on Rotor Dynamics,(1990-9), 13-18.
6. S.H.Crandall, From Whirl to whip in Rotor dynamics, Proceedings of 3rd International Conference on Rotordynamics, (1990-9), 19-26.

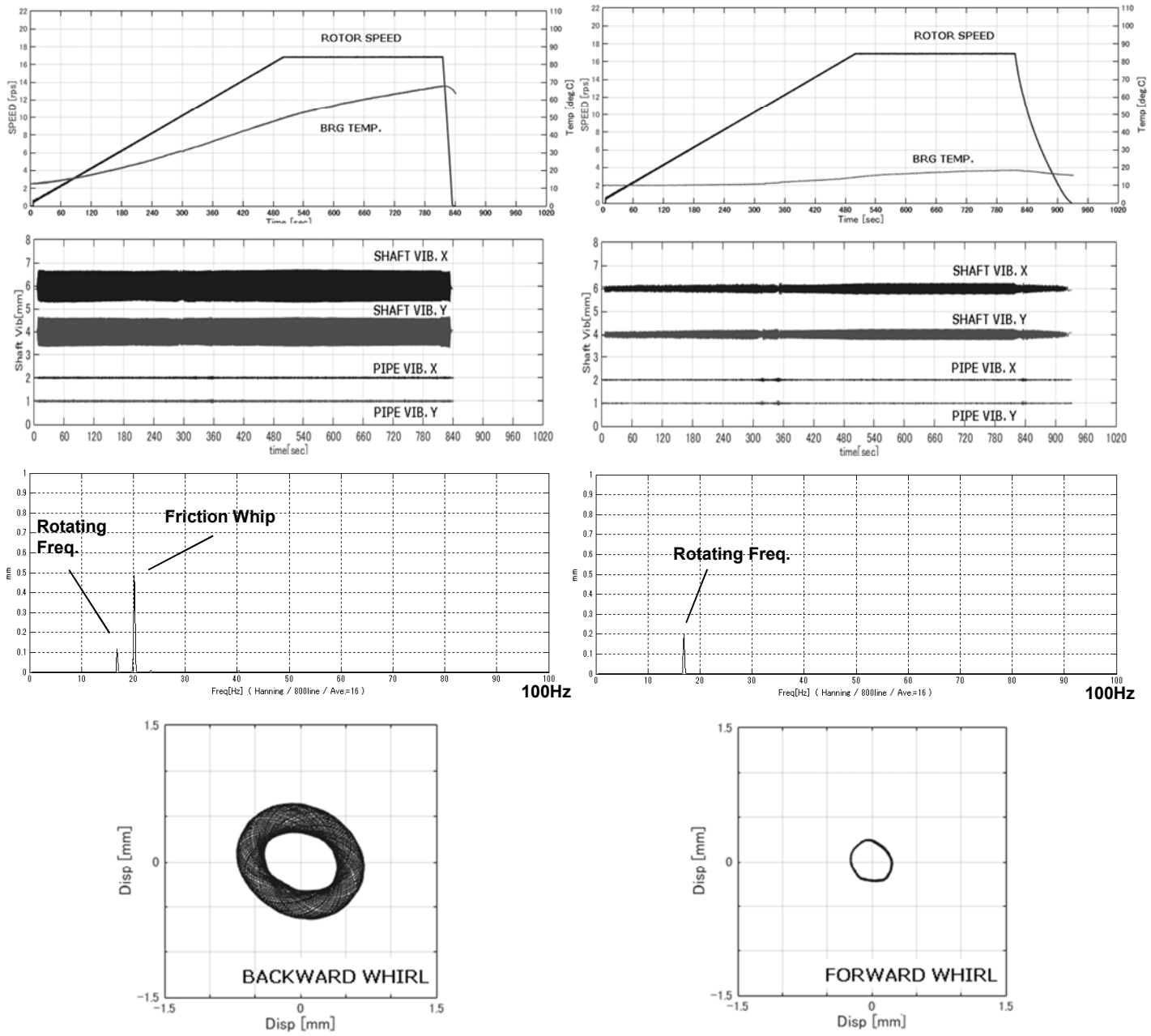

a) Without Friction Cancellor

b) With Friction Cancellor

Fig.6 Effectiveness of Friction Cancellor

Upper : Time wave of speed & BRG temp.
 Middle Upper : Time wave of vibration
 Middle Lower : Frequencies of shaft X-axis at 600sec
 Bottom : Shaft orbit at 600sec

7. J.J.YU, et al., Rotor/Seal Experimental and Analytical Study on Full Annular Rub, Transaction of ASME, Journal of Engineering for Gas Turbines and Power, 124(2002), 340-350.
8. F.F.Ehrich, The Dynamic Stability of Rotor/Stator Radial Rubs Rotating Machinery, Transaction of ASME Journal of Engineering for Industry, (1969), 1025-1028.
9. Y.Watanabe, M.Ishii, K.Sugiyama, Vertical Shaft Pump, International Patent Application Number, PCT/JP2014/069555
10. O.Matsushita, et.al Vibration of Rotating Machinery – Fundamentals of Practical Vibration Analysis-, 2009 (in Japanese)

APPENDIX

When the rotor system is assumed to be a simplified 2 DOF system with instability force, the equation of motion of system is as shown in eq. A-1. [10]

$$m\ddot{z} + j\Omega G\dot{z} + k_b z = -(c_b - j c_c)\dot{z} - j k_c z \quad \dots[A-1]$$

where,

z : complex amplitude of the rotor

G: gyroscopic coefficient

Cc : cross term of damping coefficient.

In this paper, instability caused by friction force is considered, therefore,

$$k_c = -\mu k_b \quad \dots[A-2]$$

And for simplification, G=0, Cc =0, then,

$$m\ddot{z} + k_b z = -c_b \dot{z} + j\mu k_b z \quad \dots[A-3]$$

The solution of eq.A-3 is assumed as,

$$z = a e^{j\phi} \quad \dots[A-4]$$

and,

$$\frac{da}{dt} = \varepsilon A(a) \quad \dots[A-5]$$

$$\frac{d\phi}{dt} = \omega + \varepsilon B(a) \quad \dots[A-6]$$

where, ε : small parameter.

From eq.A-4 to eq.A-6,

$$\dot{z} = j\omega a e^{j\phi} + (\varepsilon A + j\varepsilon B a) e^{j\phi} \quad \dots[A-7]$$

$$\ddot{z} = -\omega^2 a e^{j\phi} + 2j\omega(\varepsilon A + j\varepsilon B a) e^{j\phi} \quad \dots[A-8]$$

Substituting eq.A-2, A-7, A-8 in eq.A-3

$$\frac{da}{dt} = \varepsilon A = -\frac{1}{2m} \left(c_b + \frac{\mu k_b}{\omega} \right) . \quad \dots[A-9]$$

If whirling motion is backward natural frequency of rotor, $\omega = -\omega_n$.

Then, unstable condition ($a > 0$) is shown as,

$$\frac{\mu \cdot K_b}{\omega_n c_b} > 1 . \quad \dots[A-10]$$