



HAL
open science

Uncertainty sensitivity assessment on the optimization of the design and operation of complex energy systems: a comprehensive approach

Amélia Nadal, Alain Ruby, Cyril Bourasseau, Delphine Riu, Christophe Bérenguer

► To cite this version:

Amélia Nadal, Alain Ruby, Cyril Bourasseau, Delphine Riu, Christophe Bérenguer. Uncertainty sensitivity assessment on the optimization of the design and operation of complex energy systems: a comprehensive approach. ESREL 2018 - 28th European Safety and Reliability Conference, NTNU-ESRA, Jun 2018, Trondheim, Norway. pp.2627-2634. hal-01887672

HAL Id: hal-01887672

<https://hal.science/hal-01887672>

Submitted on 4 Oct 2018

HAL is a multi-disciplinary open access archive for the deposit and dissemination of scientific research documents, whether they are published or not. The documents may come from teaching and research institutions in France or abroad, or from public or private research centers.

L'archive ouverte pluridisciplinaire **HAL**, est destinée au dépôt et à la diffusion de documents scientifiques de niveau recherche, publiés ou non, émanant des établissements d'enseignement et de recherche français ou étrangers, des laboratoires publics ou privés.



Distributed under a Creative Commons Attribution - NonCommercial - NoDerivatives 4.0 International License

Uncertainty sensitivity assessment on the optimization of the design and operation of complex energy systems: a comprehensive approach

A. Nadal & A. Ruby & C. Bourasseau

Univ. Grenoble Alpes, CEA, LITEN, DTBH, 38054 Grenoble, France

D. Riu

Univ. Grenoble Alpes, CNRS, Grenoble INP, G2Elab, 38000 Grenoble, France*

C. Berenguer

Univ. Grenoble Alpes, CNRS, Grenoble INP, GIPSA-lab, 38000 Grenoble, France*

** Institute of Engineering Univ. Grenoble Alpes*

ABSTRACT: For the optimization of renewable energy systems, uncertainties associated to technical and economic parameters are scarcely taken into account, which may lead to a weak confidence in results. In this paper, we propose and investigate a 4-steps methodology for uncertainty sensitivity assessment, with the objective to improve confidence in the assessment results and to support decision-making process following techno-economic optimization of the design and the operation of an autonomous power system. The methodology is applied to off-grid system including photovoltaic production, battery and hydrogen components (electrolyser, pressure storage and fuel cell). This energy system is modelled and optimized with Odyssey – a simulation software developed by CEA-LITEN since 2010. We focus on static parametrical uncertainties, linked to the energy system parameters.

1 INTRODUCTION

1.1 *Optimization of complex energy systems*

Energy systems are getting more and more complex, and difficult to assess because of (i) the variability of the renewable power sources and of the demand, (ii) the resultant necessity of storage and (iii) the presence of different and new energy vectors. The modelling and simulation software Odyssey (Guinot 2013) enables the realization of techno-economic optimizations of such energy systems design and operation. However, many parameters used to simulate the systems are uncertain (e.g. static component performances or economic properties, but also time series of production or load profiles) and it is necessary to evaluate the impact of these uncertainties on the design and operation arising from the optimization process to help decision-making about these systems.

1.2 *Problem statement*

Up to now techno economic studies carried out with Odyssey, as with most other similar simulation tools, have not taken into account uncertainties, but only have provided sensitivity analysis on uncertain key input parameters. Thus, the objective of our work is to develop a comprehensive approach to enhance the platform with capacities of uncertainty management, from the identification of the main sources of uncertainty to results analysis and support to decision making.

We identified two main ways to account for the uncertainty influence on the results of a techno-economic optimization. The first one consists in optimizing the system taking into account the uncertain parameters so as to get results robust to the considered uncertainties. The second way consists in optimizing the system and then apply the uncertainties to evaluate the sensitivity of this optimized design to uncertainties; this paper presents an application of this second one. In the first part, we will present a 4-step methodology for uncertainty assessment. In the second part, we will present a representative example of energy system optimization, which allows dealing with problematic of competition between technologies, the problematic of energy storage in off-grid power-system and the optimization of this system design and operation without uncertainty. In the third part, we will apply our methodology on the described study case, showing how we modelled uncertainties on selected parameters and how to assess the sensitivity of results to these uncertainties. Finally, the fourth part will expose our conclusions and give directions for our future research work.

2 PROPOSED METHODOLOGY

The methodology of uncertainty treatment proposed and implemented in this work is based on the four-steps approach described by de Rocquigny (de Rocquigny 2006a, b), schematized in Figure 1. This methodology is summarized below.

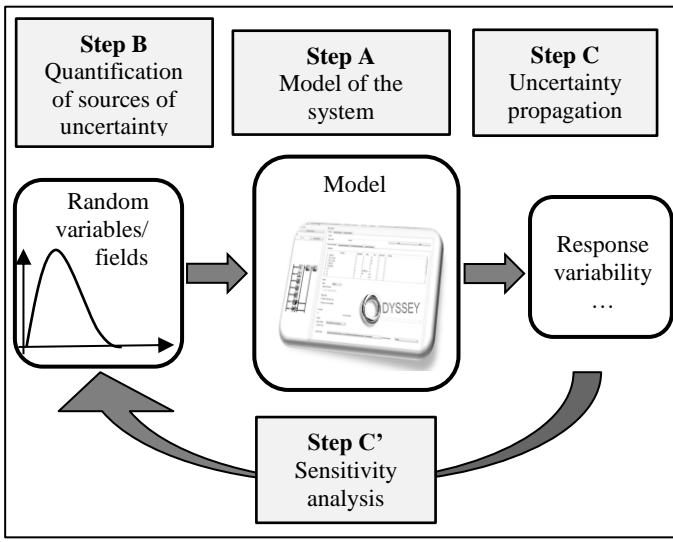

Figure 1. Uncertainty analysis common framework.

2.1 Model of the system

For step A, we assume that the considered energy system model is available and implemented in the software Odyssey, used as a black box.

The entries of this black box are technical and economic parameters divided in two types: design variables and uncertain parameters. The uncertain parameters are arbitrarily decided by the decision-maker or by the software user. On the contrary, the design variables can be set, and even optimized, like the optimization variables in Table 1. The next part will describe with precision the model of our case study.

The outputs of the black box are technical and economic indicators, which assess the performances of the design of the system. These indicators will be described later.

2.2 Uncertainty modelling

Regarding the quantification of sources of uncertainty, at step B, we model the sources of uncertainty in a probabilistic framework, with probabilistic density laws. In this study, we assume that all the considered uncertainties are independent.

The three classical probabilistic laws are considered: uniform, beta and Weibull, detailed in Table 3, in paragraph 4.1 where the whole uncertainty modelling is applied to our study case.

2.3 Uncertainty propagation

At step C, the propagation of uncertainties allows us to see how the outputs of the model respond to the uncertainties: we achieved this by coupling a Monte Carlo launcher provided by the Uranie software (Bouloré 2012) and the executable Odyssey, as schematized in Figure 2.

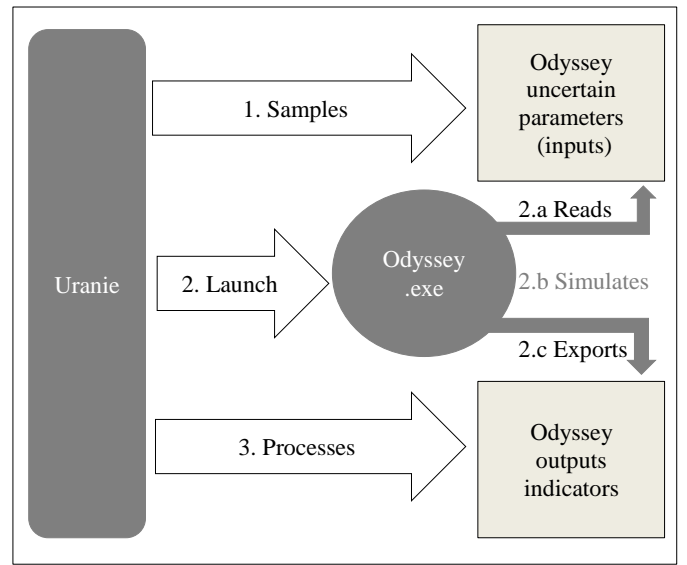

Figure 2. Odyssey/ Uranie coupling.

2.4 Sensitivity analysis

Finally, at step C', the sensitivity analysis permits to identify the uncertainties that have the strongest influence on the outputs of the model. This identification gives us the possibility to try to reduce the uncertainty of the most influent sources, in order to reduce the uncertainty of the outputs and facilitate decision making (Borgonovo 2016). Among the different methods of sensitivity analysis, we chose the Morris method and the Sobol indexes computation, which are closely complementary.

The Morris method (Morris 1991) allows first to classify the uncertain parameters in three categories:

- the parameters with negligible effects,
- the parameters with linear effect and without interaction,
- the parameters with nonlinear effects and/or interactions (without distinction of these two effect types).

This screening method presents the advantage to sort the uncertain parameters with a limited calculation cost. In fact, the Morris method requires N code computations, with:

$$N = r * (d + 1) \quad (1)$$

with:

- $r \in \llbracket 4 ; 10 \rrbracket$,
- d : number of uncertain parameters.

We used the Morris method to eliminate the uncertain parameters with negligible effects on the output indicators, in order to calculate the Sobol indexes (Sobol 1993). This second part of the sensitivity analysis requires many more code computations, which explains why the Morris method is relevant to use before. Indeed, the calculation on the Sobol indexes required N code computations, with:

$$N = n * (d + 2) \quad (2)$$

with:

- n: size of the sample,
- d: number of uncertain parameters.

The Morris method and the Sobol indexes computation combination compose the sensitivity analysis step.

3 MODELLING AND OPTIMIZATION OF THE SYSTEM WITHOUT UNCERTAINTY

3.1 Case study description

The case study investigated in this paper is a stand-alone power system located in Nigeria and is shown on Figure 3. It includes:

- an electrical load (Load),
- a photovoltaic (PV) plant,
- a bank of Lead-acid batteries,
- a complete hydrogen chain made of: a PEM electrolyser, a pressurized tank to store the hydrogen and a PEM fuel cell.

This example is representative of (i) the operating competition occurring between batteries and a hydrogen chain, (ii) the problematic of energy storage in off-grid power-system, and (iii) the PV over-sizing linked to the load satisfaction research.

The implemented power management strategy is based on the on/off switches of the electrolyser (ELY) and the fuel cell (FC), as was originally developed by Ulleberg (Ulleberg 2004), and exploited on a similar case by Guinot et al. (Guinot et al. 2015). The operation depends on the state of charge (SOC) of the battery and on levels fixing switching operations the fuel cell and the electrolyser (FC+, FC-, ELY- and ELY+, i.e. the operation parameters) given in Figure 3.

In this case study, the replacement of the components is not considered.

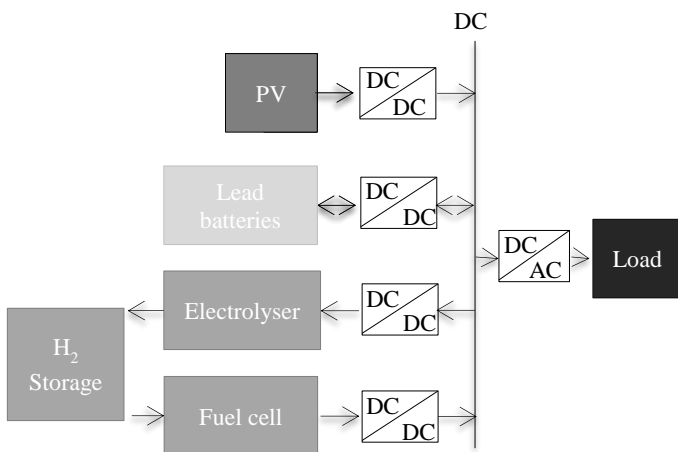

Figure 3. Architecture of the case study.

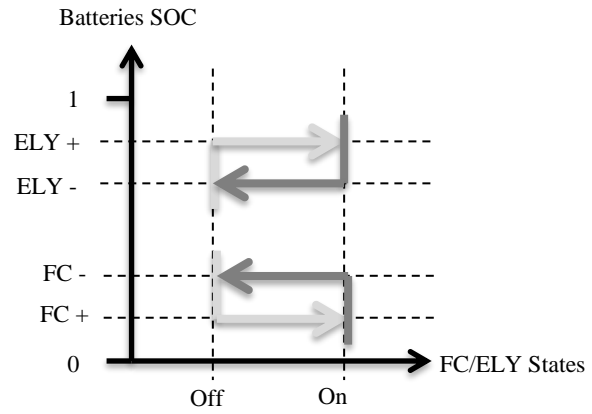

Figure 4. Power management strategy of hydrogen chain.

3.2 Optimization criteria and variables

The operation parameters are considered constant during the whole exploitation simulation. The optimization of the system operation consists in finding the best suited operation parameters to minimize both electrical cost and unsatisfied load, as for any other design parameters. No distinction is made between plant and controller optimization problems, as it would have been necessary if the operation parameters had been evolving according to the dynamic of the system (Fathy et al. 2001). However, in this study the operation are not optimized.

We selected as optimization variables the five dimensioning variables shown in Table 1.

Table 1. Optimization variables

Variable	Units	Optimization borders	
		Minimum	Maximum
Number of Modules PV*	-	1	no
Number of Battery Units**	-	1	150
Number of electrolyze cells	-	5	no
Fuel Cell Stack Max Power	W	1	no
Volume of pressure tank	m ³	1	no

* Each module has a peak power of 1 kWp.

** Each unit has a rated capacity of 10 kWh.

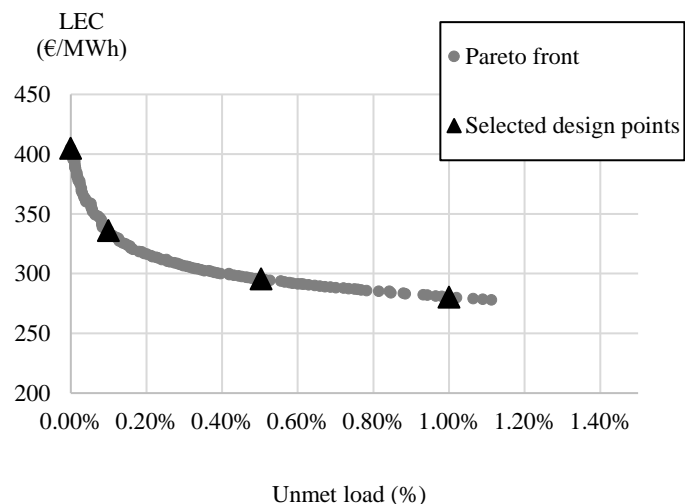

Figure 5. Pareto front resulting from the optimization of the system.

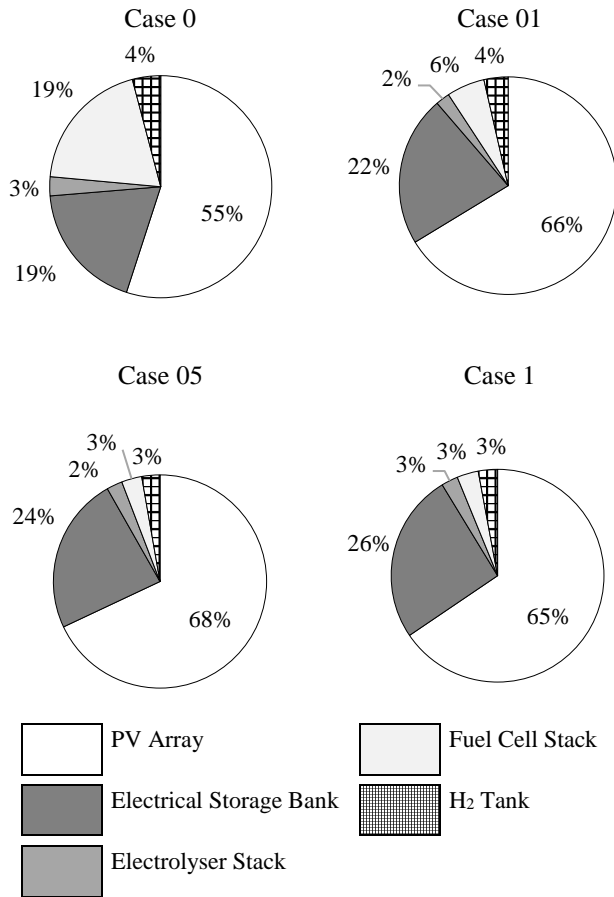

Figure 6. Cost distributions for the 4 different cases.

Odyssey multicriteria optimization process uses a genetic algorithm in order to minimize the standard Levelized Electricity Cost (LEC) in €/MWh on the one hand and to minimize the unsatisfied load (UL) in %, i.e. the energy based percentage of unmet electrical load, on the other hand. Therefore, two objective functions are in competition. It is often observed that lowering the load satisfaction, by reducing the storage system size for example, leads to a lower cost of the system and thus the cost of the produced electricity. While on the contrary, improving the satisfaction of the load by oversizing the system tends to increase the cost of the produced electricity.

The simultaneous optimization of design and operation parameters allows to take maximum benefit from each optimized design.

The multicriteria algorithm used in this work is the Strength Pareto Evolutionary Algorithm 2 (Zitzler et al. 2001).

3.3 Optimization results

Due to the competition between both optimization criteria LEC and UL, the optimization results take the shape of a Pareto front as on Figure 5. On this Pareto front, four different design points were selected corresponding to different indicators values (LEC and UL). We selected the point according to the UL and we defined four different cases named from their UL value and with the designs given in Table 2.

Table 2. Optimized study cases design and indicators

Case	0	01	05	1
Number of Modules PV (-)	735	735	660	600
Number of Battery Units (-)	146	145	135	138
Number of electrolysis cells (-)	8	5	5	5
Fuel Cell Stack Max Power (W)	43,500	10,500	5000	5000
Volume of pressure tank (m ³)	31	16	3.5	3.5
Unsatisfied load (%)	0	0.1	0.5	1
LEC (€/MWh)	404.9	336.1	295.5	280.2
Unused Primary Production (%)	39.2	39.7	33.1	26.8

The resulting cost distribution for the four selected cases given in Figure 6 illustrate the relative importance of the component costs within the overall system cost. We noticed that the component influencing the most the price was the PV array, which contributes for more than the half of it, in every case, followed by the battery bank (electrical storage). The fuel cell has a significant part in the price only in the case 0, which is intuitive regarding to the maximal power of the fuel cell stack (Table 2).

This part describes the way we identified and selected the optimal system designs without uncertainty consideration. In the following, we will investigate the influence of uncertainties on the selected cases (optimized without uncertainties) and through them on the Pareto front. In fact, these four cases show similar cost distributions and thereby, it is interesting to observe if applying uncertainties may modify the comparison between them. As we optimized operating parameters, it will however not be possible to check whether operating parameters may counter-balance the effect of uncertainties on the design or not.

4 APPLICATION OF THE PROPOSED METHODOLOGY TO THE CASE STUDY

4.1 Uncertainty Modelling

In this paper, we decided to focus on static parametrical uncertainties, linked to the energy system parameters. We have identified 25 parameters sources of uncertainty, all with an epistemic nature. In fact, the parameters of components that are not completely mature (such as the electrolyser and the fuel cell) are not well known. Moreover, even the mature components do not have parameters with perfectly known values.

An extensive literature research has been carried out to identify existing, validated or accepted uncertainty probabilistic models for components of energy systems. Table 3 summarizes the different uncertain characteristics of the system components considered in the study, with their associated probability distribution, and with the reference for the chosen uncertainty model. Uniform probability distributions have been associated to the uncertain characteristics of the

innovative components (in order to report the equiprobability between the possible values) and to the uncertain parameters of mature components when no other “better” (e.g. from expert judgements) distribution is available.

There are too many uncertain parameters to be described exhaustively, but the following subsections will focus on three particularity types.

4.1.1 Uncertain parameters modelled by polynomial models

Three uncertain parameters, i.e. the cell voltage of the electrolyser, the efficiency of the fuel cell and the CAPEX of the hydrogen pressure tank are modelled by polynomials, respectively functions of the current density in the electrolyser, the pressure (P/Pnominal) of the fuel cell and the volume of the hydrogen pressure tank. We assumed that only the constant coefficient was uncertain, thus generating an area of possible values instead of a curve.

4.1.2 Uncertain parameters of the photovoltaic panels

No technical parameter of the photovoltaic panels was considered as uncertain in this paper. This is due to the fact that the solar production is defined directly by a time series data representing the electrical production, not considered as uncertain in this paper.

4.2 Uncertainty propagation through Odyssey

The immediate effect of the uncertainties are observed thanks to the Monte Carlo approach using the Odyssey model. Then the dispersions of the indicators (LEC and unmet load) are analysed. They are not the same for these two indicators and they depend on the case, i.e. on the design of the system. A realization of all the uncertain parameters is sampled, and based on this realization the system is simulated using its Odyssey model to propagate the uncertainty on the model output performance indicators (UL and LEC). This simulation is iterated for 300 Monte Carlo history. The results are given in Figure 7.

Table 3. Uncertain parameters and associated probability distributions (Uniform, Beta or Weibull)

Component Parameter <i>Unit</i>	Law	Reference
PV		
CAPEX $\text{€}/Wp$	β [$\alpha = 1.8$; $\beta = 6$; Min = 0.374; Max = 3.165]	IRENA (2016)
OPEX $\% \text{ CAPEX}$	U [2; 10]	i.d.*
Battery bank		
CAPEX $\text{€}/Wh$	β [$\alpha = 1.31$; $\beta = 3.5$; Min = 0.102; Max = 0.354]	Battke et al. 2013
OPEX $\% \text{ CAPEX}$	U [2; 10]	i.d.*
Capacity loss Wh/h	U [1.4E-5; 4.2E-5]	Riffonneau et al. 2007
Self-discharge W	U [3.75E-5; 1.4E-4]	IRENA 2017
Charge efficiency -	β [$\alpha = 1$; $\beta = 4$; Min = 0.8; Max = 0.9]	Battke et al. 2013
Discharge efficiency -	β [$\alpha = 1$; $\beta = 4$; Min = 0.8; Max = 0.9]	Battke et al. 2013
Electrolyser		
CAPEX $\text{€}/W$	U [6.5; 13.1]	i.d.*
OPEX $\% \text{ CAPEX}$	U [2; 10]	i.d.*
Degradation $\mu V/h$	U [0.4; 15]	Bertuccioli et al. 2014
Cell voltage**	U [1.39; 1.54]	i.d.*
FC		
CAPEX $\text{€}/W$	U [2.2; 8]	i.d.*
OPEX $\% \text{ CAPEX}$	U [2; 10]	i.d.*
Degradation $\mu\%/h$	U [0.45; 1.35]	Kurtz et al. 2015
Efficiency**	U [0.30; 0.34]	FutureE Fuel Cell Solutions GmbH
H₂ tank		
CAPEX**	U [18,055; 28,239]	i.d.*
OPEX $\% \text{ CAPEX}$	U [2; 10]	i.d.*

* internal data

** see 4.1.1

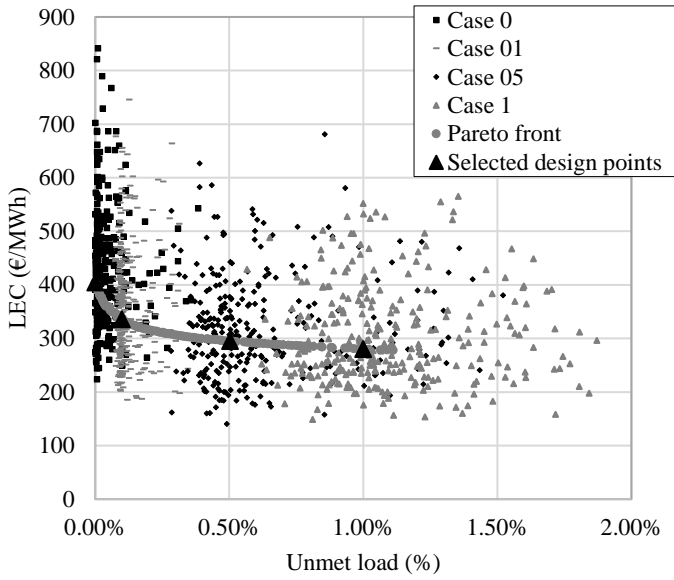

Figure 7. LEC and UL indicators for the four selected design configurations with uncertainties.

We observe the relative dispersion of the LEC and the unmet load, calculated by the ratio of the standard deviation and the average (Fig. 8). The relative dispersion of the unmet load decreases significantly from case 0 to case 1, i.e. inversely to the nominal unmet load characteristic of the design. While the relative dispersion of the LEC increases slowly from case 0 to case 1, i.e. also inversely to the nominal LEC characteristic of the design.

4.3 Sensitivity assessment

After propagating uncertainties, the sensitivity analysis described below aims to identify the most influential uncertain parameters on the output variance.

4.3.1 Application of Morris method

The Morris method permits us to select those uncertain parameters that have a non negligible influence on the output indicator (marked with + in the Table 4). Both for the LEC and the UL, whatever the design configuration, the method eliminates the same parameters.

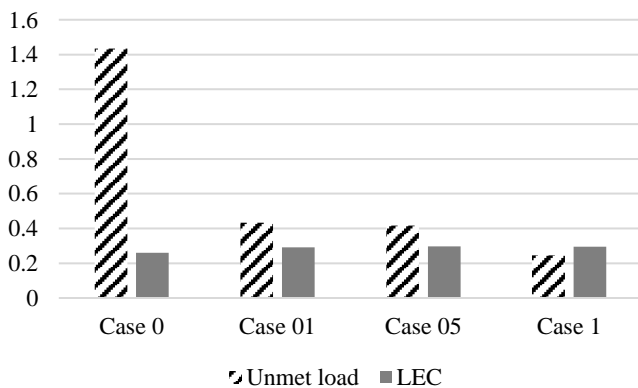

Figure 8. Relative dispersion of LEC and UL for the four study cases.

However, the eliminated parameters are not the same for LEC and the UL. Indeed, the UL is decorrelated from the economic parameters, so we do not keep them for the Sobol indexes calculation. On the contrary, the LEC is not influenced only by economic parameters, since it depends also on the electricity production. For the Sobol indexes calculation related to the LEC, we also keep the more influential technical parameters based on the Morris method.

Table 4. Morris method results

Component	Parameter	Unit	LEC	Unmet load
PV				
CAPEX	€/W _p		+	-
OPEX	% CAPEX		+	-
Battery bank				
CAPEX	€/Wh		+	-
OPEX	% CAPEX		+	-
Capacity loss	Wh/h		+	+
Self-discharge	W		+	+
Charge efficiency	-		-	+
Discharge efficiency	-		+	+
Electrolyser				
CAPEX	€/W		+	-
OPEX	% CAPEX		+	-
Degradation	μV/h		-	+
Cell voltage	V		-	+
FC				
CAPEX	€/W		+	-
OPEX	% CAPEX		+	-
Degradation	μ%/h		-	+
Efficiency	-		-	+
H₂ tank				
CAPEX	€/m ³		+	-
OPEX	% CAPEX		+	-

4.3.2 Analysis with Sobol indexes

The Sobol indexes give with precision the contributions of the variance of one output indicator due to the considered parameters.

4.3.2.1 Unmet load

Considering the unmet load variance, the Sobol indexes represented in the Figure 9 indicate that the most influencing uncertain parameter, whatever the case, is the capacity loss of the battery, followed by the discharge efficiency of the battery. The importance of these two parameters, linked to the battery bank shows the major role played by this component in the load satisfaction. The discharge efficiency is much more influential than the charge efficiency, because the PV panel installation is oversized and therefore the solar production is in excess, limiting the role of the charge efficiency. The charge efficiency takes a bigger importance only in case 05 and case 1 (responsible of respectively 3 and 5% of the unmet load variance) where the PV panel installation size is

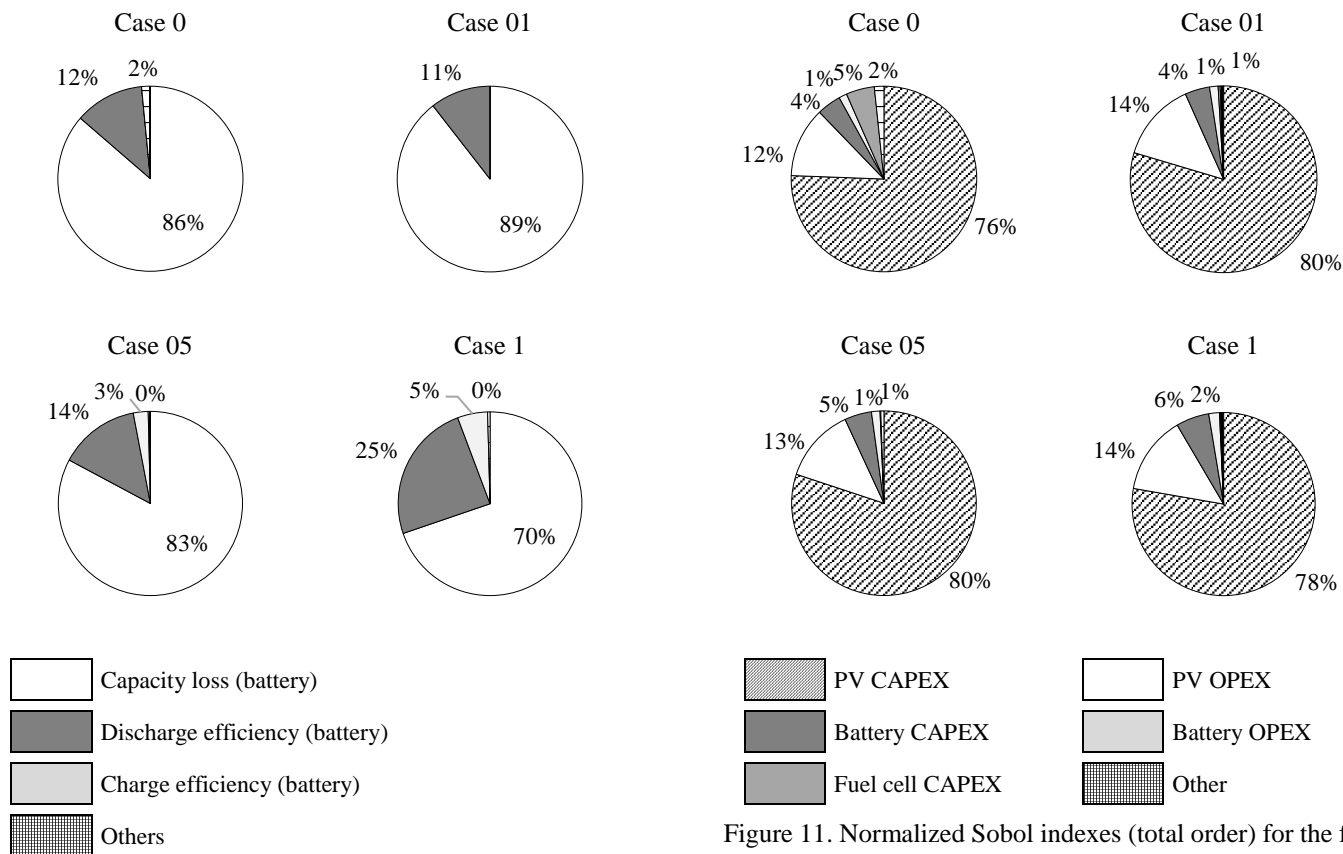

Figure 9. Normalized Sobol indexes (total order) for the four different cases, related to the unmet load.

The ascendancy of the battery on the hydrogen chain is due to the design and the control of those. The powers delivered by the battery on one side and by the hydrogen chain (i.e. by the fuel cell) on the other side illustrate that the hydrogen chain supplies a negligible electric power, even in the case 0, in which the fuel cell has the biggest design, i.e. in which the hydrogen chain production is the most favorable (Fig. 10).

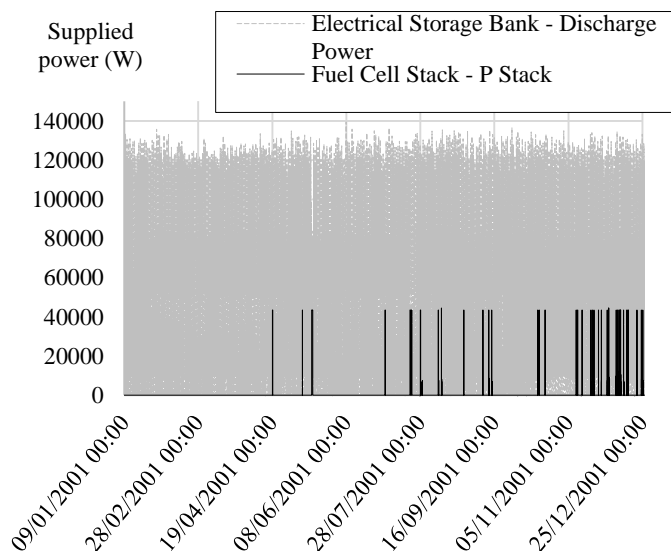

Figure 10. Powers supplied by the hydrogen chain and the battery bank in the case 0.

Figure 11. Normalized Sobol indexes (total order) for the four different cases, related to the LEC.

4.3.2.2 Levelized Electricity Cost

The Sobol indexes indicate that whatever the case, the most influential uncertain parameter on the LEC variance is the PV CAPEX, far before the PV OPEX and to a lower degree the battery bank CAPEX.

We notice that the hydrogen chain plays a significant role in the unmet load variance only in the case 0, i.e. with its largest design: 26% of the total cost in its integrality and 19% for the fuel cell (Fig. 6).

We can observe that if the Sobol index of a given parameter is linked to the cost weight of the corresponding component (studied in Section 2), there is however no direct proportional relation, because of the influence of the probability distribution of the input parameters values. For instance, the battery bank that plays an important role in the system cost (between 19% and 26%) has a relatively small impact (inferior than 8%) on the LEC variance. While the PV panel installation, which is the main contributor to the system cost, but no more than 68%, represents (CAPEX and OPEX unified) the overwhelmingly part (between 88% and 94%) of the LEC variance cause.

5 CONCLUSIONS AND FUTURE RESEARCH WORK

In this paper, we investigated a comprehensive 4-steps methodology to evaluate the impact of uncertainties, in order to improve the confidence in the assessment results of a complex autonomous power system modelled and optimized with Odyssey. We first chose to optimize the system before considering the uncertainties that were considered uncertainties as independent.

The results of the uncertainty propagation and of the sensitivity analysis teach us that the most influencing uncertain parameters are linked to the design of the system and in our case study are:

- the capacity loss followed by the discharge efficiency of the battery for the unmet load,
- the PV CAPEX followed by the PV OPEX and the battery CAPEX for the LEC.

There are several interesting points that still have to be thoroughly investigated. We want to investigate now (i) the incidence of the choice of the probabilistic distributions associated to the uncertain parameters, (ii) the inclusion of the uncertainty relative to time series, (iii) the optimization of operation parameters as a way to counter-balance uncertainties on the design of the system, and mainly (iv) the optimization taking directly into consideration the uncertainties.

6 REFERENCES

- Battke, B., Schmidt, T.S., Grosspietsch, D., Hoffmann, V.H., 2013. A review and probabilistic model of lifecycle costs of stationary batteries in multiple applications. *Renewable and Sustainable Energy Reviews* 25, 240–250. <https://doi.org/10.1016/j.rser.2013.04.023>
- Bertuccioli, L., Chan, A., Hart, D., Lehner, F., Madden, B., Standen, E., 2014. Study on development of water electrolysis in the European Union.
- Borgonovo, E., Plischke, E., 2016. Sensitivity analysis: A review of recent advances. *European Journal of Operational Research* 248, 869–887.
- Bouloré, A., Struzik, C., Gaudier, F., 2012. Uncertainty and sensitivity analysis of the nuclear fuel thermal behavior. *Nuclear Engineering and Design*, SI: CFD4NRS-3 253, 200–210. <https://doi.org/10.1016/j.nucengdes.2012.08.017>
- Chardonnet, C., De Vos, L., Genoese, F., Roig, G., Bart, F., De Lacroix, T., Ha, T., Van Genabet, B., 2017. Study on early business cases for H2 in energy storage and more broadly power to H2 applications.
- De Rocquigny, É., 2006a. La maîtrise des incertitudes dans un contexte industriel. 1re partie: une approche méthodologique globale basée sur des exemples. *Journal de la société française de statistique* 147, 33–71.
- De Rocquigny, É., 2006b. La maîtrise des incertitudes dans un contexte industriel. 2nde partie: revue des méthodes de modélisation statistique physique et numérique.
- Fuel Cells and Hydrogen Joint Undertaking, 2014. Multi - Annual Work Plan 2014 - 2020.
- FutureE Fuel Cell Solutions GmbH, n.d. Jupiter Product Family Sophisticated Fuel Cell Systems.
- Guinot, B., 2013. Evaluation multicritère des technologies de stockage couplées aux énergies renouvelables: conception et réalisation de la plateforme de simulation ODYSSEY pour l'optimisation du dimensionnement et de la gestion énergétique (phdthesis). Université Grenoble Alpes.
- Guinot, B., Champel, B., Montignac, F., Lemaire, E., Vannucci, D., Sailler, S., Bultel, Y., 2015. Techno-economic study of a PV-hydrogen-battery hybrid system for off-grid power supply: Impact of performances' ageing on optimal system sizing and competitiveness. *International Journal of Hydrogen Energy* 40, 623–632. <https://doi.org/10.1016/j.ijhydene.2014.11.007>
- International Energy Agency, 2014. Technology Roadmap Solar Photovoltaic Energy.
- IRENA, 2017. Electricity Storage and Renewables: Costs and Markets to 2030. Abu Dhabi.
- IRENA, 2016. The Power to Change: Solar and Wind Cost Reduction Potential to 2025.
- Kurtz, J., Huyen, D., Ainscough, C., Saur, G., 2015. Fuel Cell Technology Status: Degradation.
- Morris, M.D., 1991. Factorial Sampling Plans for Preliminary Computational Experiments. *Technometrics* 33, 161–174. <https://doi.org/10.2307/1269043>
- Riffonneau, Y., Barruel, F., Seddik, B., 2007. Problématique du stockage associé aux systèmes photovoltaïques connectés au réseau.
- Sobol, I.M., 1993. Sensitivity estimates for non linear mathematical models.
- Ulleberg, Ø., 2004. The importance of control strategies in PV-hydrogen systems. *Solar Energy, Solar World Congress 2001* 76, 323–329. <https://doi.org/10.1016/j.solener.2003.09.013>
- Weckend, S., Wade, A., Heath, G., 2016. End-of-Life Management: Solar Photovoltaic Panels.
- Zitzler, E., Laumanns, M., Thiele, L., 2001. SPEA2: Improving the strength pareto evolutionary algorithm (Working Paper). Eidgenössische Technische Hochschule Zürich (ETH), Institut für Technische Informatik und Kommunikationsnetze (TIK).