



HAL
open science

Deviation propagation analysis along a cumene process by using dynamic simulations

Carlos Murillo, Fatine Berdouzi, Nelly Olivier-Maget, Nadine Gabas

► **To cite this version:**

Carlos Murillo, Fatine Berdouzi, Nelly Olivier-Maget, Nadine Gabas. Deviation propagation analysis along a cumene process by using dynamic simulations. *Computers & Chemical Engineering*, 2018, 117, pp.331-350. 10.1016/j.compchemeng.2018.06.010 . hal-01886696

HAL Id: hal-01886696

<https://hal.science/hal-01886696>

Submitted on 3 Oct 2018

HAL is a multi-disciplinary open access archive for the deposit and dissemination of scientific research documents, whether they are published or not. The documents may come from teaching and research institutions in France or abroad, or from public or private research centers.

L'archive ouverte pluridisciplinaire **HAL**, est destinée au dépôt et à la diffusion de documents scientifiques de niveau recherche, publiés ou non, émanant des établissements d'enseignement et de recherche français ou étrangers, des laboratoires publics ou privés.







Open Archive Toulouse Archive Ouverte

OATAO is an open access repository that collects the work of Toulouse researchers and makes it freely available over the web where possible

This is an author's version published in: <http://oatao.univ-toulouse.fr/20891>

Official URL: <https://doi.org/10.1016/j.compchemeng.2018.06.010>

To cite this version:

Murillo, Carlos  and Berdouzi, Fatime  and Olivier, Nelly  and Gabas, Nadine  *Deviation propagation analysis along a cumene process by using dynamic simulations*. (2018) *Computers & Chemical Engineering*, 117. 331-350. ISSN 0098-1354

Any correspondence concerning this service should be sent to the repository administrator: tech-oatao@listes-diff.inp-toulouse.fr

Deviation propagation analysis along a cumene process by using dynamic simulations

Murillo Carlos, Berdouzi Fatine, Olivier-Maget Nelly, Gabas Nadine*

Laboratoire de Génie Chimique, Université de Toulouse, CNRS, Toulouse 31030, France

A B S T R A C T

The dynamic response of benzene alkylation process to a set of deviations is analyzed with Aspen Plus Dynamics. A quantitative risk assessment is developed through simulations of deviation scenarios. The process comprises a reactor and three distillation columns with a recycle stream. The simulation scenarios are determined according to lessons learnt from accidents. This study underlines the conditions that induce an overpressure or a flooding in a distillation column. Three scenarios are proposed: feed flowrate variations, coolant flowrate reduction and cooling of the reboiler steam. Thereafter, the results allow calculating a set of risk indexes related to flooding and overpressure phenomena. This study underlines the deviation propagation effects that can be expected in all the process equipment. Moreover, it represents a significant contribution to the definition of the process control strategy and the necessary safety barriers.

1. Introduction

The analysis of consequences that can be caused by a process deviation is usually performed with a risk assessment methodology. Recently, quantitative or semi-quantitative approaches have emerged due to increasing requirements of process and technology developments (Tian et al., 2015). Nowadays, it is admitted that risk assessment should be envisaged as a complementary approach in which the technical expertise is supported by simulation tools (Berdouzi et al., 2016). In this order, dynamic simulations improve the knowledge and understanding of the dynamic characteristics of a chemical process by relating its dynamic output response to an input disturbance (Ingham et al., 2007). In this manner, it allows estimating various control strategies as well as the optimization of the control settings of the process.

The objective of dynamic simulations is to predict how fast variables change in the event of an operating emergency or equipment failure (Luyben, 2012a). This analysis determines the time period to reach critical limits (safety response time) and permits the engineer to quantitatively design effective safety systems (Luyben, 2012b). Therefore, dynamic simulations can contribute to the characterization of process deviations in future risk analyses (Tian et al., 2015). In the literature, numerous papers deal

with dynamic simulation-based HAZOP analyses (Isimite and Rubini, 2016; Tian et al., 2015). In this manner, risks are quantified thanks to the knowledge of the process abnormal behavior (Gabbar et al., 2003). This description of the dynamic evolution of the operating parameters allows recommending the appropriate safety barriers (Luyben, 2012a) and evaluating new safeguard methods (Bodizs et al., 2015).

Our study envisages the dynamic simulation of an industrial plant with ASPEN PLUS DYNAMICS 9.0 in order to analyze the propagation of a set of specific deviations. A preliminary study was carried out to show the feasibility of the method (Murillo et al., 2017). Firstly, a case study is modeled under steady-state conditions and a list of possible disturbances is defined according to lessons learnt from previous accidents occurred in the distillation columns (ARIA, 2016; Kister, 1997, 2003). Next, the dynamic simulation underlines how each deviation might lead to hazardous events and their associated risks. Moreover, the method allows to know the behavior of the process during the degraded modes and to quantify the severity of accidental scenarios. Thus, the final goal is to recommend the required safety barriers (nature, sizing and response time).

2. Case study

The chemical process that is considered for this case study envisages the industrial alkylation of benzene by propene to isopropylbenzene, which is also denominated as cumene (C₉H₁₂). This chemical process can be developed continuously with a vapor-phase or liquid-phase reaction. Before 1990, the former manufac-

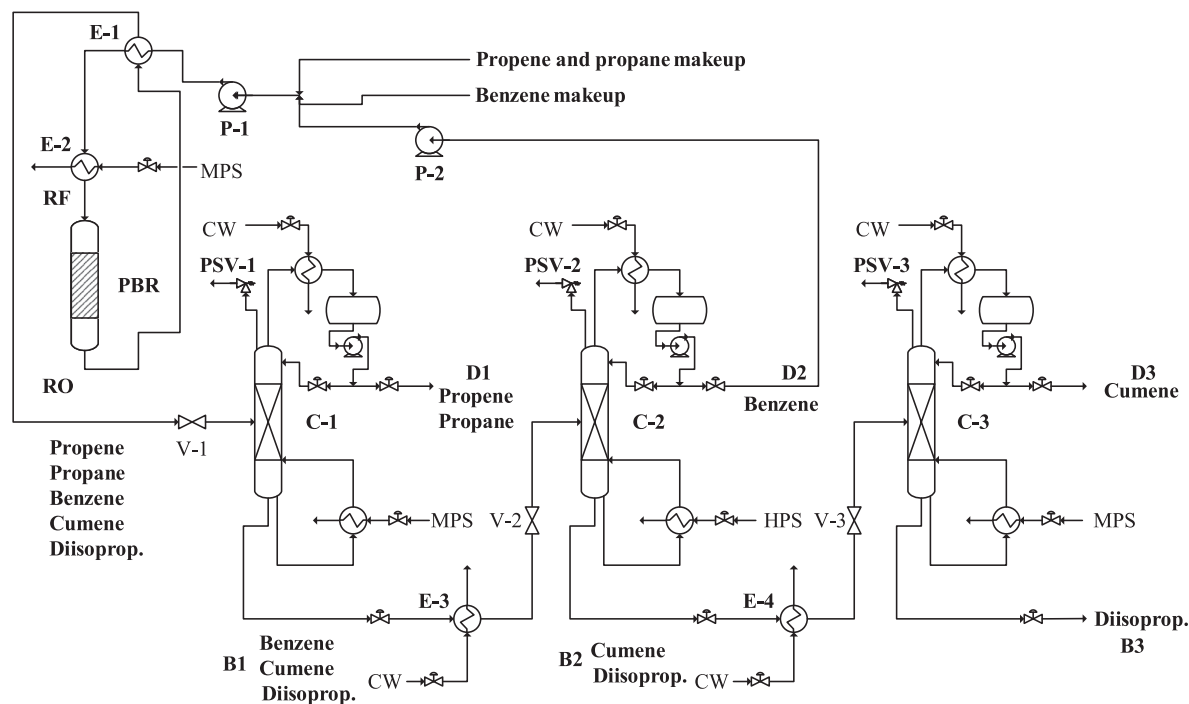

CW: Cooling water HPS: High pressure steam MPS: Medium pressure steam

Fig. 1. Process flowsheet of the industrial alkylation of benzene with propene to cumene.

turing route prevailed over the liquid-phase alternative. Nevertheless, the development of the alkylation reaction with zeolites as catalysts has allowed considering the latter as a more appropriate technique (Bellussi et al., 1995; Corma et al., 2000). Besides the production of cumene, the alkylation process also implies the production of polyalkylates and polyisopropylbenzenes as well as propylene oligomers due to a set of consecutive reactions. For this reason, the alkylation reactions are carried out with large pore zeolites (e.g. MCM-22) and a molar feed ratio of benzene/propylene over 4:1. These operating conditions provide a major significance of the production of the cumene and the diisopropylbenzene ($C_{12}H_{15}$) with regard to other by-products. Further information about the physicochemical properties of the zeolites and their influence on the selectivity of the reaction can be consulted in the experimental study developed by (Corma et al., 1995).

2.1. General description of the process

The work presented in this paper considers the manufacturing process of cumene from benzene and propene in the liquid phase with zeolites as catalysts. Previous studies have characterized the cumene production in the vapor phase as well as its control structure (Gera et al., 2013; Luyben, 2010). In this study, the production is in the liquid phase and the process shown in Fig. 1, which is composed of a Packed Bed Reactor (PBR) and a train of distillation columns (C-1 to C-3). The separation equipment recovers benzene, which is the excess reagent, to be recycled to the reactor. Additionally, the columns recover and purify cumene along with a by-product of the process (diisopropylbenzene). These characteristics constitute an important simulation complexity since the recycle promotes the propagation of operating parameter deviations.

The case study is an industrial plant that produces 87.6 ktons per year with a global manufacture efficiency of 95% (Fig. 1). The dynamic simulation is developed according to the operating conditions specified by Dimian and Bildea (2008) for the PBR and the distillation columns. Initially, a makeup stream of $91.3 \text{ kmol}\cdot\text{hr}^{-1}$

Table 1

Global apparent kinetic parameters of the benzene alkylation to cumene and diisopropylbenzene (Dimian and Bildea, 2008).

Chemical reaction	Chemical reaction rates
Benzene alkylation $C_6H_6 + C_3H_6 \rightarrow C_9H_{12}$	$r_1 = 6510 \exp\left(-\frac{52564}{RT}\right) C_{C_6H_6}$
Cumene alkylation $C_9H_{12} + C_3H_6 \rightarrow C_{12}H_{15}$	$r_2 = 450 \exp\left(-\frac{50000}{RT}\right) C_{C_9H_{12}}$

of benzene is fed along with a makeup stream of $100.9 \text{ kmol}\cdot\text{hr}^{-1}$ of aliphatic hydrocarbons: propane and propene. This stream is mainly composed of the alkene whose molar fraction is 99%. Additionally, both streams are mixed with the recycle of the second distillation column in order to have a benzene/propylene ratio of 7:1 in the reactor feed (RF). This ratio ensures the desired selectivity to cumene at the reactor outlet (RO).

The process consists of a reaction unit and a separation unit that recovers the unreacted compounds and purifies the alkylated hydrocarbons. The first unit carries out the alkylation reactions in the PBR. This is a tubular adiabatic equipment whose diameter and length are 1.3 and 10 m respectively. This reactor is filled with the bed of the solid catalyst (d_p equal to 2.4 mm) to constitute a void fraction equal to 0.4. This reactor configuration defined the simulation scheme proposed by Dimian and Bildea (2008) as well as the kinetic parameters of the cumene and diisopropylbenzene production according to the operating conditions of the process equipment. This scheme poses a pseudo-first-order reaction adjusted to the temperature range of the industrial reaction unit ($150\text{-}230^\circ\text{C}$) and a high benzene/propylene feed ratio (5-8:1). Thus, the Arrhenius expressions that are listed in Table 1 are obtained by calculating two apparent kinetic constants that take into account not only the chemical reaction but also the mass transfer phenomena occurring in the liquid phase. The activation energies of the Arrhenius equations are expressed in $\text{kJ}\cdot\text{mol}^{-1}$ and the reaction rates in $\text{kmol}\cdot\text{m}^{-3}\cdot\text{s}^{-1}$.

Table 2
Design specifications of the distillation columns of the separation unit.

Design specification	C-1	C-2	C-3
Separation specification	Aliphatics in distillate: Recovery: 99.0% Purity: 99.9%	Benzene in distillate: Recovery: 99.9% Purity: 99.0%	Cumene in distillate: Recovery: 99.5% Purity: 99.0%
Condenser	Total (Logarithmic mean temperature difference)	Total (Logarithmic mean temperature difference)	Total (Logarithmic mean temperature difference)
Condenser pressure (bar)	12.0	3.0	1.0
Reboiler	Kettle Constant steam temperature	Kettle Constant steam temperature	Kettle Constant steam temperature
Height (m)	3.9	6.0	5.0
Number of stages	13	19	18
Feed stage	6	10	9
Reflux ratio	44.52	0.157	0.325

The performance of the reaction unit is established by the conversion of propene, which is 93.1% at steady-state conditions. Similarly, the selectivity of the alkylation reactions is established as the ratio of the moles of the mono and disubstituted hydrocarbons that are produced in the packed bed reactor. The high benzene/propene ratio determines a steady-state operation with the production of 25.8 moles of cumene per mole of diisopropylbenzene. Subsequently, the products of the reactor are separated in the second unit, which consists of a series of three distillation columns packed with pall rings. First, they are fed to a distillation tower (C-1) that separates the aliphatic compounds (propane and unreacted propene in D1) from the aromatic hydrocarbons, which are concentrated at the bottom of the column (B1). This separation demands a high reflux ratio (Table 2) because the fraction of aliphatic compounds is negligible with regard to that of aromatic hydrocarbons. Then, the aromatic compounds are fed to a second tower (C-2) that separates the unreacted benzene (D2) from the alkylated hydrocarbons (B2). Thereafter, the recovered benzene is recycled to the reactor. Finally, the distillate of the third column (C-3) is composed of high purity cumene (D3) whereas the bottoms are constituted by the remaining diisopropylbenzene (B3). Moreover, the industrial process can add another column to purify this hydrocarbon from other high molecular weight by-products. The separation sequence of the distillation towers is defined to ensure a good recovery of the light compound fed to each tower. The design and separation specifications of the columns are shown in Table 2.

Additionally, Fig. 1 also presents the heat exchangers that are included in the flow diagram of the chemical process (E-1 to E-4). The exchangers E-1 and E-2 are positioned in a network that preheats the reactive mixture with the outlet stream of the reactor and medium pressure steam (MPS) respectively. On the contrary, the other two exchangers reduce the temperature of the feed streams of the columns C-2 and C-3 with a coolant fluid as a utility. Finally, two pumps (P-1 and P-2) are implemented in the chemical process to pressurize the makeup streams and the recycle of the column C-2 until 36 bar. This pressurization level is set in order to avoid a phase change of the reactive mixture within the reactor. Similarly, the valves (V-1 to V-3) are included to adjust the feed pressure of the distillation columns. These elements allowed equalizing the pressure of each feed stream to the corresponding pressure of the feed stage.

The conditions are determined by a steady-state simulation of the chemical process that is developed with the software ASPEN PLUS 9.0™ under a sequential modular approach. This scheme implies the definition of unit block operations that are solved one at a time in sequence by the simulator by considering the inlet stream variables and a set of specified parameters (Smith, 2016). For this study, the thermodynamic model is based on the Peng–Robinson equation since the system is only composed of hydrocarbons whose critical pressures range between 24.5 bar (diisopropy-

lbenzene) and 48.9 bar (benzene). These values are considerably higher than the operating conditions of the process equipment with vapor-liquid equilibria.

2.2. Control structure of the process

The plantwide control structure of the chemical process is also presented in Fig. 2:

It is divided into three nodes: reactor, intermediate heat exchangers, and columns. In the first group, the total feed flowrate of the reactor is regulated by manipulating the flowrate of the benzene makeup stream (FC), which is the chemical compound with the highest flowrate in the recycle stream. In the same manner, the temperature of the feed stream of the reactor is controlled with the utility temperature of the heat exchanger E-2 (TC). The second group consists of the temperature controllers of the other intermediate heat exchangers (E-3 and E4). The objective is to reduce the feed stream temperature of the distillation columns C-2 and C-3. This regulation is achieved by manipulating the coolant flow of each heat exchanger (TC). The control parameters of these nodes are listed in Table 3.

Additionally, the third group of control loops regulates the performance of the distillation columns. Five control loops are usually considered for this type of equipment (Luyben, 2006; Wang et al., 2016). Firstly, the condenser pressure is regulated by manipulating the coolant flowrate (PC). The liquid levels of the reflux drums are controlled by adjusting the distillate flowrates (LC). In the same manner, the liquid levels of the sumps are controlled with the manipulation of the bottoms flowrates (LC). Besides, there is a temperature control in a specific stage of each column (TC). It adjusts the temperature of the heating steam in the boiler in order to stabilize the stage with the highest variation in the temperature profile of the vessel. This strategy is proposed by Luyben (2006) for the temperature control of a distillation column. The last control loop corresponds to a ratio control (X) between the feed flowrate and the reflux rate for each column of the separation unit. The control parameters of the distillation columns are listed in Table 4.

The dynamic simulation is developed by exporting the steady-state simulation to ASPEN PLUS DYNAMICS 9.0™ as a flow-driven mode. This definition is determined by considering that the outlet temperatures of the process streams in the intermediate heat exchangers are below the corresponding boiling points. To make a dynamic simulation, it is necessary to define the models that represent the process equipment. For instance, a logarithmic mean temperature difference is used for the condensers and the intermediate heat exchangers (E-1 to E-5 in Fig. 1). The modelling of the reboilers of the columns is commonly based on the constant temperature model. Then, the control loops described above are implemented in the dynamic simulation in order to analyze the response of the control structure after the occurrence of a given

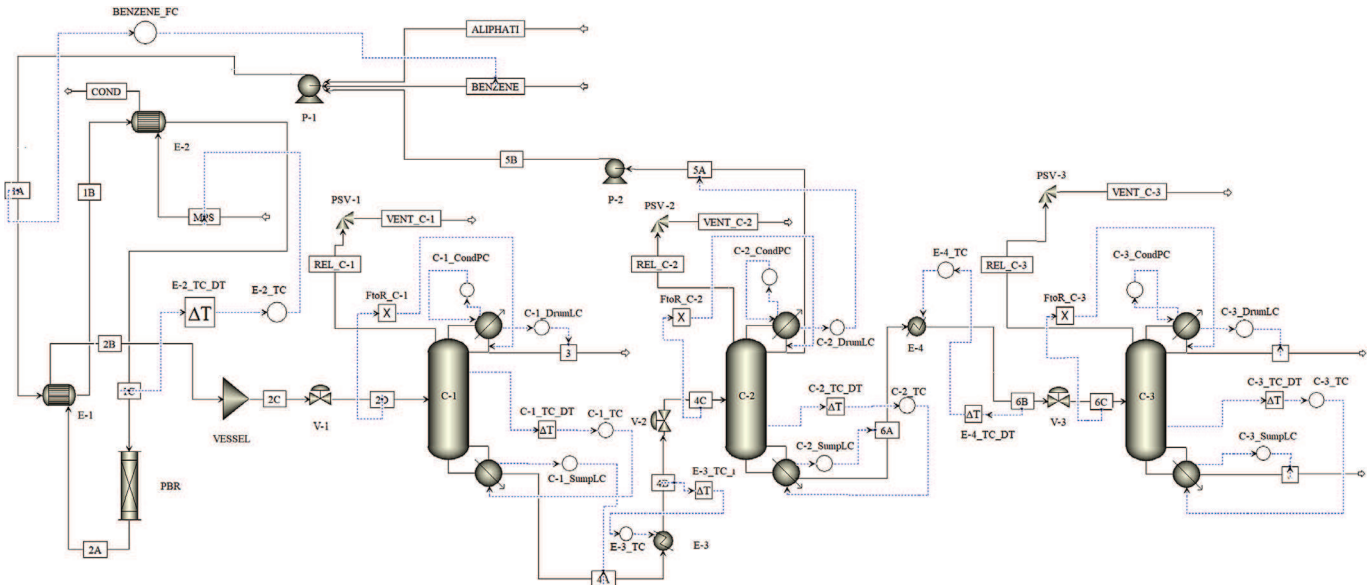

Fig. 2. Aspen plus dynamics flowsheet of the cumene process.

Table 3

Control parameters of the packed bed reactor and the intermediate heat exchangers.

Position (control loop)	Action	Type	Controlled variable	Manipulated variable
Reactor Feed Flow (BENZENE_FC)	Reverse	PI	Feed flowrate	Benzene flowrate
Heat exchanger E-2 (E-2_TC)	Reverse	PID with dead time	Feed temperature	Temperature of heating steam
Heat exchanger E-3 (E-3_TC)	Direct	PI with dead time	Outlet temperature	Cooling fluid flowrate
Heat exchanger E-4 (E-4_TC)	Direct	PID with dead time	Outlet temperature	Cooling fluid flowrate

Table 4

Control parameters of the distillation columns.

Position	CONTROL LOOP	ACTION	TYPE	Controlled variable	Manipulated variable
REFLUX DRUM	C-1_CondPC C-2_CondPC C-3_CondPC	Direct	PI	Pressure	Cooling fluid flowrate
REFLUX DRUM	C-1_DrumLC C-2_DrumLC C-3_DrumLC	Direct	P	Level	Distillate rate
SUMP	C-1_SumpLC C-2_SumpLC C-3_SumpLC	Direct	P	Level	Bottoms rate
REFLUX	FtoR_C-1 FtoR_C-2 FtoR_C-3	Direct (Multiplier)	X	Reflux to feed ratio	Reflux rate
COLUMN	C-1 - Stage 03 C-2 - Stage 15 C-3 - Stage 16	Reverse	PID with dead time	Temperature	Temperature of heating steam

disturbance or deviation. All the parameters of the controllers are tuned according to a conventional method such as Ziegler-Nichols. Some details about the simulation settings have been added but for more information; the reference of our works in this field (Berdouzi, 2017) is cited in the text.

2.3. Process safety valves

Figs. 1 and 2 show the process safety valves PSV-1, PSV-2, and PSV-3, which are positioned at the top of each distillation column as a safety barrier, upstream to the condenser. As PSV devices are essential for the process safety. In order to simulate the real functioning of the process safety valves, it is possible to represent their opening and closing by a schematic lift-pressure diagram that is commonly called as PSV hysteresis. The characteristic PSV param-

Table 5

Hysteresis and design parameters of the process safety valves.

Design specifications	PSV-1	PSV-2	PSV-3
Set pressure - SP (bar)	14.40	3.60	2.00
Primary lift valve position - PLVP (%)	10	10	10
Full lift pressure, opening -FLO (bar)	15.12	3.78	2.10
Full lift pressure, closing -FLC (bar)	14.40	3.60	1.30
Reseating pressure - RP (bar)	13.68	3.42	1.10
Reseat valve position - RVP (%)	50	50	50

eters are mentioned in Fig. 3 and Table 5. These settings allow a PSV response that constitutes an immediate response to an overpressure without generating oscillations due to the action of pressure controllers.

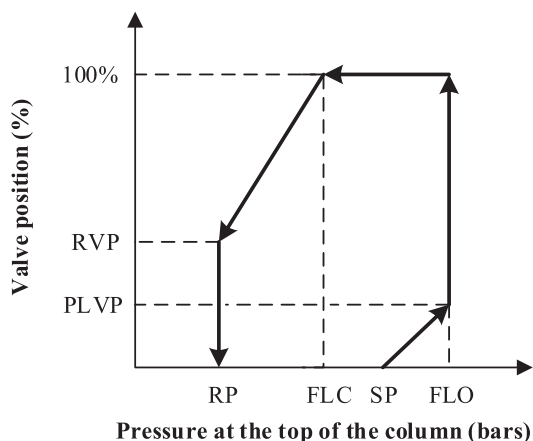

Fig. 3. Hysteresis diagram of a process safety valve.

Fig. 3 illustrates the functioning of a PSV. At the pressure set SP, the process safety valve gradually opens until the Primary Lift Valve Position PLVP (10%). At the Full Lift Opening Pressure FLO, the process safety valve totally opens. It remains open until the Full Lift Closing Pressure FLC. Then, the process safety valve gradually closes until the Reseat Valve Position RVP (50%). When the pressure is equal to the Reseating Pressure RP, the process safety valves are totally closed. For the cumene process, the different thresholds are chosen in accordance with the recommendations of the DIERS method (Design Institute for Emergency Relief System) constituted by the AIChE engineers (American Institute of Chemical Engineers). The sizing of the process safety valves is performed by estimating the overhead vapor rate of a vent release. The different diameters of the process safety valves are determined according to the DIERS method (Etchells and Wilday, 1998; Gustin, 2006, 2009). The sizing criterion of this method can be associated with failures of the control valves, reflux, power or coolant supply or even an exterior fire. The scenario considered for this purpose corresponds to a total loss of heat removal in the condensers since it represents the major increases in the top pressure. It is in accordance with the vent sizing strategy recommended by Kister (1990). The bore diameter is determined according to a standard code (API 520-I, 2008). Table 5 gives the specifications of the PSV.

3. Simulation scenarios

The simulation scenarios of this study are defined in this section according to a review of accidental reports. This analysis evaluates the factors that can generate an abnormal operation in a distillation column. Then, the simulation of these scenarios allows evaluating their potential effects on the chemical process.

3.1. Literature review

According to Kister (2003), the number of malfunctions in distillation columns is increasing in spite of the advances in the distillation technology. The lessons learnt from accidents are not always effectively communicated and the undesired malfunctions are incessantly repeated. Kister (1997) has listed the main failures and deviations that cause abnormal operations in the distillation towers. The failure concerns the malfunction of a device whereas a deviation considers any change from the normal operating conditions.

The obtained data associate the operating problems mainly with troublesome column internals and operational difficulties. These causes are followed by instrumentation and control failures

and facility mishaps. These four factors represent 60% of the reported cases and are the most common malfunctions considered by the troubleshooters. Most of the remaining cases correspond to design mistakes, startup/shutdown difficulties, and heat exchangers failures. The knowledge of these factors is determining since they can represent 27% of the reported malfunctions. Finally, the remaining cases are linked to the tray and downcomer layout, foaming and relief problems.

The dynamic response of the plant-wide structure can be characterized by a set of scenarios that describes the behavior of the manufacturing process. This analysis constitutes a great advantage in the development of a risk assessment since it allows evaluating the behavior of different process variables at the same time. However, it is necessary to define a clear scope in the analysis of the simulation results since many elements can be omitted due to a general study of the chemical process. For this reason, this discussion envisages the dynamic response of the cumene process equipment but focuses on the negative effects occurred in the separation unit. This case study mainly considers scenarios associated with column flooding and overpressure. These phenomena are analyzed because they may result in a hydrocarbons leak in the columns. The abnormal operation of a distillation column under these circumstances is described as follows:

- **Flooding:** This inoperability condition is caused by an excessive retention of liquid inside the column. This issue is due to a high vapor/liquid loading (Gorak and Schoenmakers, 2014). This abnormal operation is mainly associated with changes in the tanks levels, increases in the pressure drop and deterioration of the mass transfer efficiency (Gorak and Schoenmakers, 2014; Treybal, 1980).
- **Overpressure:** The deviations and failures that can lead to an overpressure of a distillation column depend strictly on its design and operating conditions. However, the most common sources and causes can be grouped in the checklist that was proposed by Kister (1990). These reasons are listed in Table 6.

3.2. Lessons learnt from previous accidents

The accidents occurred in distillation column are related to different causes according to the accidents reports. The lessons learnt from accidents study is a common practice and plays a key role in the improvement of safety of industrial processes (Kletz, 2009). There are several accident databases available for this purpose. For example, we can quote the European MARS (Major Accident Reporting System), the American CSB (Chemical Safety Board) and the French ARIA (Analysis, Research and Information on the Accidents). The latter database is chosen for this study since it is well-documented on the accident causes and also takes into account the foreign accidents.

A review of the lessons learnt in the ARIA database is performed in this study. This analysis only considers the events that led to major losses between 1990 and April 2017 (explosion, fire, leaks, and vent to reliefs or flares). The causes and the consequences of the 81 accidents found in the ARIA database are analyzed in Fig. 4. The human errors (22.9%) and the material (20.8%) represent the main causes. Similarly, the survey established that fire (58.3%) and vent release (20.8%) are the most frequent consequences whereas a minor fraction results in a vapor cloud explosion (5.2%).

The surveys and lessons learnt have shown that sometimes the column flooding or overpressure lead to an accident due to vent releases or leaks. An example of this situation is illustrated in the investigation report of the BP Texas refinery accident that occurred in 2005 (US Chemical Safety Board, 2007). The bottoms of a raffinate splitter tower heated up its feed stream in an exchanger

Table 6
Factors responsible for the distillation column overpressure (Kister, 1990).

Failures and deviations	Causes
Utility failure	<ul style="list-style-type: none"> • Loss of coolant (heat removal) • Loss of electric power • Loss of steam • Loss of instrument air
Controller failure or Human error under manual operation	<ul style="list-style-type: none"> • Failure of the steam controller • Failure of the pressure controller • Failure of the feed controller • Failure of the reflux (or pumparound) controller (or pump)
Extraneous sources	<ul style="list-style-type: none"> • Valve opening to an external pressure source • Loss of heating in an upstream column • Failure of exchanger • Exterior fire
Internal sources	<ul style="list-style-type: none"> • Accumulation of noncondensables • Chemical reaction • Closes column outlets
Transient sources	<ul style="list-style-type: none"> • Pockets of water in a hot tower • Steam hammer • Internal explosions

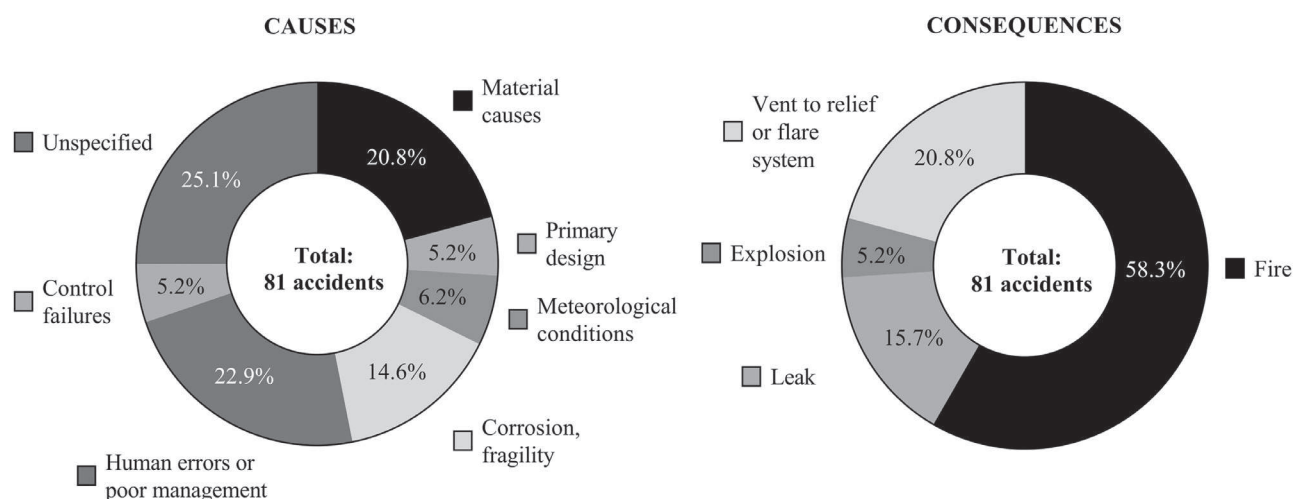

Fig. 4. Causes and consequences of malfunctions in distillation columns from ARIA database (1990–2017).

network. The failure of one of the level controls of this column caused its excessive level increase. This abnormal operation also augmented the temperature of the liquid stored in the column. Then, the interaction of the energy network caused that the hot bottoms also heated up the feed flow to hazardous levels. Both failures caused the flooding of the column and the subsequent overflowing (Kalantarnia et al., 2010; Manca and Brambilla, 2012). This deviation initiated a sequence of events that led to the release of an explosive vapor cloud, which later ignited and caused 15 deaths and 170 injuries. Certainly, this case illustrates the influence of the variations of the feed conditions (operational difficulty) and the failures of the control systems. This case also shows that the disturbances in a distillation column might become more relevant when the chemical process is interactive due to the presence of a recycle stream (Smith and Corripio, 1985). The interactions among the process units enhance the propagation of a disturbance; hence, they must be taken into account for the evaluation of consequences during a risk assessment.

Likewise, other computational characterizations of the control structures of distillation columns (Bezzo et al., 2004; Ebrahimzadeh and Baxter, 2016; Luyben, 2012a) have also analyzed the drastic coolant flowrate reduction as the main hazardous event due to a high pressurization of the systems in which this deviation has occurred. An example of this situation is registered on the accident reports of the database of the Bureau of Analysis of Risks and Industrial Pollution (BARPI ARIA, abbreviated in French). The report N° 45,345 of this database registers the leakage of 55 tons of methanol on March 16, 2013, in a biodiesel production center in Limay, France. The main cause is attributed to the failure of a motor of the refrigeration system that increased the temperature and the pressure of a distillation column. This fact led to the subsequent release through a rupture disk. This example describes how the refrigeration loss emerged from an electric failure that affects the coolant supply.

Previous dynamic analyses have simulated cooling system failures by setting the pressure control to a manual mode and re-

ducing the flowrate of the corresponding coolant. In this manner, all the cooling factors that may cause an overpressure of the system can be represented. This situation has already been associated with accidents occurred in the industry. For instance, the report N° 22,626 of the BARPI [ARIA \(2016\)](#) reports a loss of containment in a gasoline stabilization column of a refinery located in Feyzin (France) in 2002. The release of a pressurized hydrocarbons mixture was caused by the opening of a process safety valve. The final report attributed the accident to an overheating occurred during the startup of the column when the pressure was manually regulated by the operator.

3.3. Definition of the simulation scenarios

The literature and lessons learnt from accidents established how a change in the feed conditions and the heat removal failure might lead to flooding or overpressure in a distillation column. These deviations are simulated in the benzene alkylation process in order to estimate their propagation effects. Additionally, [Kister \(1990\)](#) listed the failures and deviations leading to an overpressure in a distillation column and their potential associated causes ([Table 6](#)). One of these deviations is also evaluated in order to estimate its potential impacts on the chemical process as well. For this case, an extraneous source related to the heating efficiency is studied. In accordance with this definition, this study analyzes three different types of scenarios according to a deviation of the following process variables:

- Flowrate of the makeup streams (feed conditions).
- Coolant flowrate of each condenser (heat removal).
- Steam temperature of the reboilers (heating in an upstream column).

The direct influence of these variables on the performance of the train of distillation columns is established with the description of the deviation effects on the chemical process units as well as the potentially hazardous consequences. Subsequently, the flooding and overpressure risks associated with these deviations are estimated according to the simulation results. For this purpose, each deviation is implemented in a simulation scenario as a step change in one of the process variables listed above. The deviation of each scenario occurs after a steady-state period of 6 h. Thereafter, the dynamic response of the system is analyzed for an additional period of 24 h. In this manner, it is possible to establish the effects of the deviation propagation with a description of the transient behavior of some key process variables. The dynamic simulations are developed without considering some complementary safety barriers such as alarms, operator's response or integrated safety systems. Thus, the protection layers analyzed in this study only correspond to basic process control systems and pressure relief devices.

4. Variation of the flowrate of the makeup streams (scenarios 1 to 4)

The first type of simulation scenarios deals with the flowrate variation of the makeup stream composed of propene and propane. The steady-state value of this variable is $100.9 \text{ kmol hr}^{-1}$. The deviations are simulated by setting a step variation of the flowrate of the stream "ALIPHATI" ([Fig. 2](#)). For this analysis, four scenarios are simulated with different values of this makeup stream flowrate:

- Scenario 1: Aliphatic flowrate reduced by 15%
- Scenario 2: Aliphatic flowrate reduced by 5%

- Scenario 3: Aliphatic flowrate increased by 5%
- Scenario 4: Aliphatic flowrate increased by 15%

4.1. Effects of the deviation on the performance of the packed bed reactor

The action of the flow controller due to the flowrate deviation of aliphatic hydrocarbons modifies the propene/benzene ratio. This fact causes an important change of the conversion and selectivity of the alkylation reactions. [Fig. 5](#) shows that a surge of the propene flowrate increases its conversion due to a higher concentration of this hydrocarbon in the reactive mixture. However, it also enhances the production of diisopropylbenzene, which represents a decrease of the chemical reactions selectivity. This fact allows concluding that the deviations of the flowrates have opposite effects on conversion and selectivity ([Fig. 5](#)). It can also be noted that the process reaches a new steady state after each disturbance.

Furthermore, the variations of the benzene alkylation rates in the packed bed reactor induce the propagation of the deviation through the separation unit. This fact can be explained by the conversion results in the reactor. The cumene and diisopropylbenzene flowrates change according to the benzene variation. As a result, the feed flowrates of the three distillation columns change as well. These effects can be clearly observed by analyzing the flowrates of the following streams: Reactor outlet (RO), bottoms of C-1, C-2 and C-3 and the distillate of C3. For this purpose, the responses of these variables to the greatest propene flowrate variations ($\pm 15\%$) are compared with the normal operation values in [Fig. 6](#).

[Fig. 6](#) shows that the makeup streams variations have an effect on the chemical process behavior. The effects observed in the reaction conversion and selectivity represents a significant variation in the flowrates of each hydrocarbon along the process. Despite the fact that the deviation only modifies the propene molar fraction in the reactor feed between 0.10 (-15%) and 0.14 ($+15\%$), there is an important variation in the cumene and diisopropylbenzene flowrates: a decrease of 22% (-15%) and an increase of 18% ($+15\%$). These deviations are not temporary but permanent; hence, they induce another steady-state condition for the industrial process. These results show that the deviation propagation can induce magnified effects along the process units. Thus, it is also necessary to analyze the performance of the separation equipment. This analysis allows identifying the hazardous events that might emerge due to a significant variation of the composition of the reactor feed stream.

4.2. Effects of the deviation on the performance of the distillation columns

The only scenario that generates an overpressure of one of the distillation columns corresponds to an increase of 15% of the aliphatic makeup stream. The column C-3 is submitted to a pressure increase of 0.34 bar when this deviation occurs ([Fig. 7](#)). The pressure control loop of this column determines a new steady-state pressure at the top of the column. This overpressure is below the set pressure (SP) and the primary lift (PL) pressure specified for the valve PSV-3 in [Table 5](#). Therefore, the safety valve does not open and the top vapors are not vented for this deviation. This result establishes that an increase of 15% in the propene makeup flowrate does not constitute an accident by itself but it contributes significantly to a pressure increase at the top of the column C-3. This abnormal operation might result in an accident if the effects are enhanced by another hazardous event (e.g. failure in a distillation temperature control).

Furthermore, the flooding of a distillation column represents an uncontrollable accumulation of liquid in the packed bed that makes a continuous operation of the column more difficult

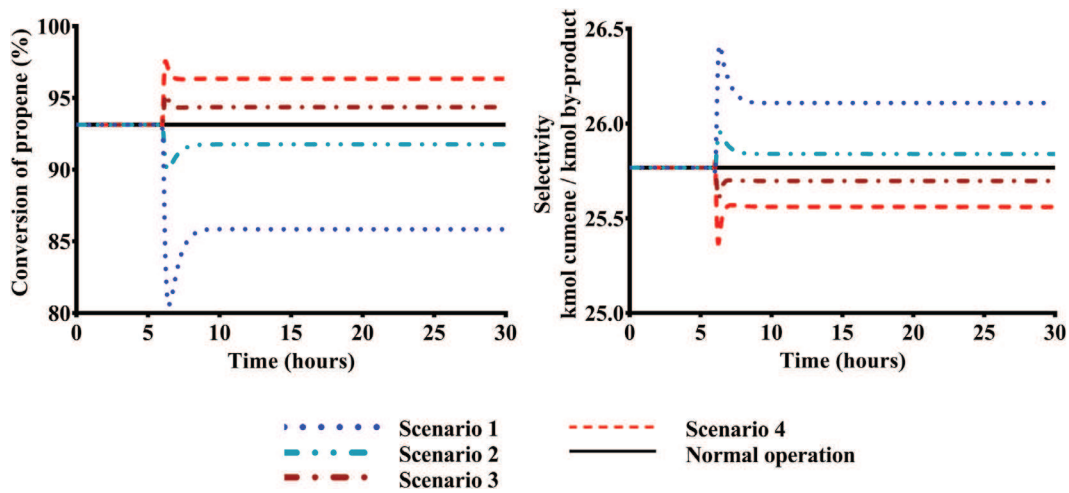

Fig. 5. Evolution of the propene conversion and the cumene selectivity during the deviation.

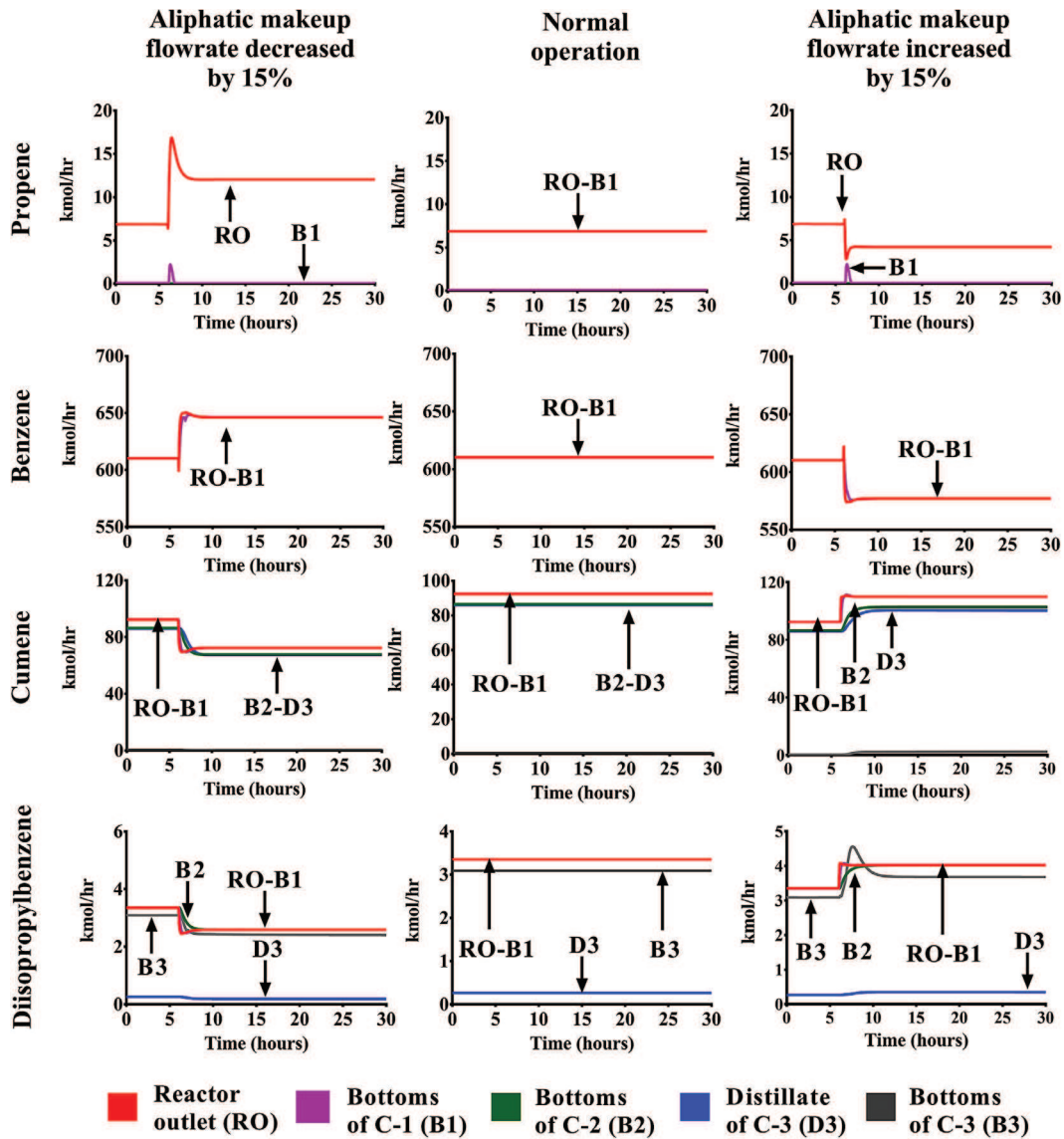

Fig. 6. Influence of makeup flowrate variation on the molar flowrates.

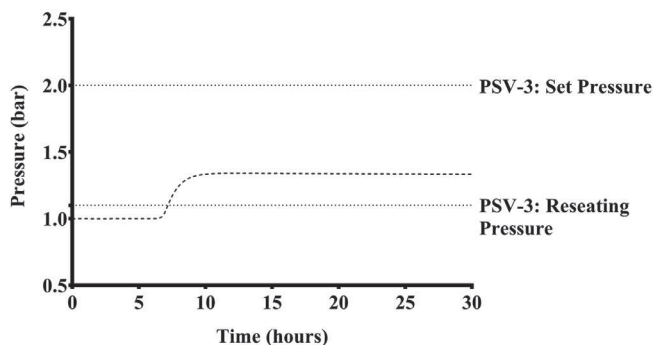

Fig. 7. Pressure increase of the distillation column C-3 for the scenario 4.

(Kister, 1990). This abnormal operation demands not only the feed flowrate regulation but also the action of the temperature and pressure controllers in order to regulate the heat transfer in the reboilers and the condensers and adjust the liquid/vapor ratio in the column. The flowrate variations also affect the hydraulic performance of the distillation columns. Indeed, flooding or entrainment can emerge in the column if the liquid or gas rates are excessive. For this reason, columns that operate with non-foaming liquids are usually designed for gas velocities lower than 80% of the critical flooding velocity (Treybal, 1980). The column stage flooding factor is defined as the ratio between the gas velocity and its critical value in this theoretical stage.

Let us consider the case where the flowrate represented by 'propene and propane makeup' in Fig. 1 changes $\pm 15\%$ (scenarios 1 & 4). These deviations propagate in several stages:

- The packed bed reactor is the first equipment affected by the deviation. The conversion and selectivity of the chemical reactions change in accordance with the reagent ratio. The composition of the reactor outlet (RO in Fig. 1) changes.
- Then, column C-1 is fed by the outlet of the reactor. In consequence, the separation in this column is modified due to variations in the vapor-liquid equilibria. The flowrates and compositions of the distillate and bottoms of this column (D1 & B1) vary with regard to the normal operating conditions.
- A similar propagation effect is observed in columns C-2 and C-3.
- Moreover, the propagation is enhanced by the presence of a recycle stream, which corresponds to the distillate flowrate of column C-2 (D2). The loop generates a secondary effect on the reactor feed (RF). This fact increases the propagation effects listed in the previous bullets.

In order to illustrate these propagations, Fig. 8 represents the flooding factors in the distillation columns during the deviations (scenarios 1 & 4). Their dynamic responses are classified into three different behaviors according to the influence of the hydrocarbon with the highest flowrate in C-1 and C-2 (benzene):

Firstly, the flooding factors of the column C-1 evidence a drastic change during a period of 1.5 h approximately. This observation is due to the surge of benzene when propene flowrate is decreased (Fig. 8A) or due to the surge of the alkylated hydrocarbons when it is increased (Fig. 8D). This abnormal operation represents an important deviation that is caused by the high reflux ratio (44.5) that is required to separate the small amounts of the aliphatic hydrocarbons. However, the flooding variations are temporary due to the regulation of the flow controller that is installed on the feed stream of the packed bed reactor.

Secondly, the changes of the flooding factors of C-2 is smaller but sustained. Fig. 8B and E show that the second column is moderately affected. Indeed, it normally separates the unreacted

benzene ($600 \text{ kmol}\cdot\text{hr}^{-1}$ approximately). Therefore, the distillate flowrate only varies between -4.4% for the scenario 4 and $+4.7\%$ for the scenario 1. As a result, no significant effect is observed in the liquid holdup.

Finally, Fig. 8C and F show a greater variation in the last column due to the changes of the feed flowrates of the alkylated hydrocarbons (Fig. 6). This result underlines how the deviation propagates through all the process equipment and induces a flooding phenomenon.

Finally, Fig. 9 shows the influence of the deviation magnitude on the number of flooded stages of the distillation columns. The extent of a deviation has a radical influence on its correction and the system behavior (Labovský et al., 2007). For this reason, the initial and final numbers of flooded stages in the most affected columns (C-1 and C-3) are compared for the $\pm 5\%$ and $\pm 15\%$ scenarios. The simulation allows establishing the critical values for the process deviation by analyzing the dynamic response in both columns. Fig. 9A shows that the temporary abnormal operation associated with the partial flooding of the column C-1 is enhanced by the increase of the benzene flowrate. The reduction of -5% to -15% implies the change from one to six flooded stages. Therefore, the equipment is submitted to a longer period of instability due to the flooding. Similarly, Fig. 9B shows that the affectation of the increase of the aliphatic compounds from $+5\%$ to $+15\%$ represents the flooding of seven additional stages.

This section of the paper only discusses the deviation effects on the flooding level of the distillation columns. Nonetheless, this analysis can be completed by the study of the evolution of other process variables. For example, consider the steam consumption in the distillation column C-1 when the aliphatic makeup flowrate is decreased by 15% . For this deviation, the propene flowrate diminution implies the increase of the benzene flowrate at the reactor outlet. This fact leads to a greater concentration of this compound at the feed of the column. The greater presence of heavy compounds in this column alters the vapor-liquid equilibria. Thus, it is necessary to have a higher steam consumption ($+20\%$) in order to regulate the temperature of stage 3 of column C-1.

5. Coolant flowrate reduction in one of the distillation columns (scenarios 5 to 7)

The second type of simulation scenarios envisages the coolant flowrate reduction in the condenser of one of the distillation columns in accordance with the lessons learnt discussed in Section 3.2. For this purpose, three additional scenarios are proposed for the analysis of the dynamic simulations. The simulation results describe the response of the chemical process to the reduction of the coolant flowrate in one of the distillation columns. The following deviations are simulated by setting a pressure controller to manual mode and adjusting the value of the coolant flowrate to 20% of the steady-state value.

- Scenario 5: Coolant flowrate reduced by 80% in C-1
- Scenario 6: Coolant flowrate reduced by 80% in C-2
- Scenario 7: Coolant flowrate reduced by 80% in C-3

5.1. Effects of the deviation on the performance of the distillation columns

The heat removal reduction represents a variation of the thermal loads in all the downstream heat transfer equipment. Initially, the failure of the cooling unit increases the outlet temperature of the remaining coolant but the action is insufficient. In consequence, the column modifies its vapor and liquid flowrate profiles and deteriorates its separation efficiency. This fact enhances the propagation of the deviation since the feed compositions and

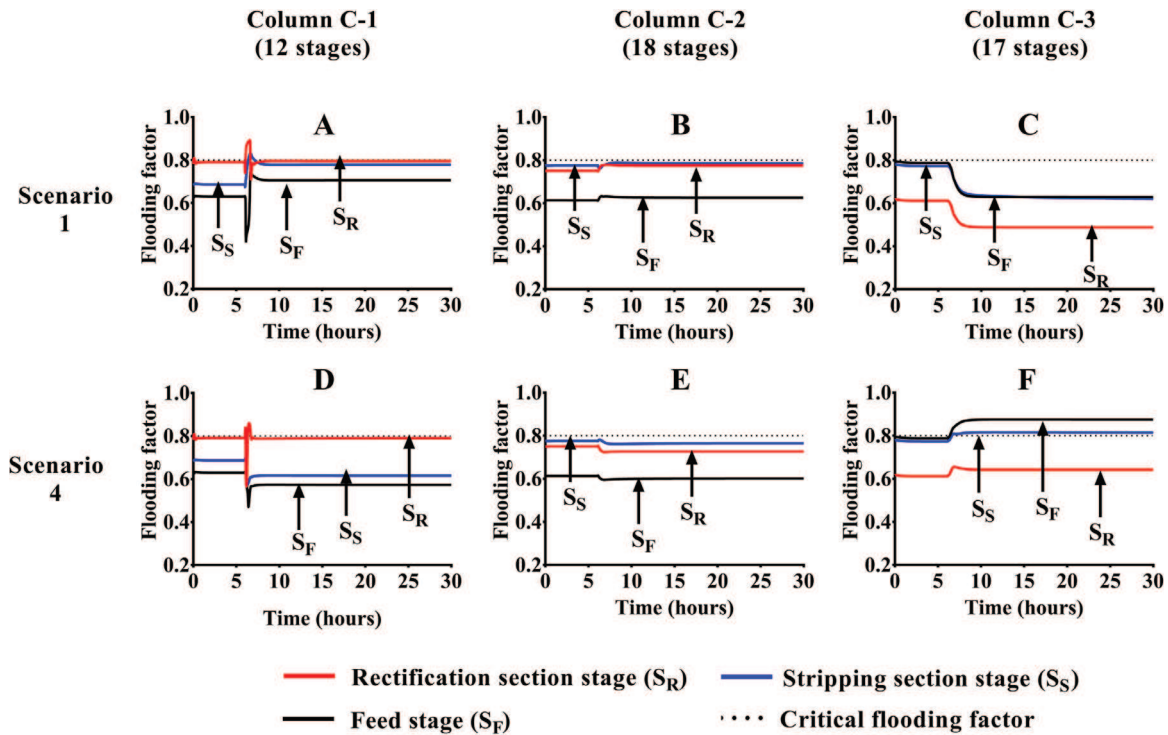

Fig. 8. Variations of the flooding factors of the distillation columns caused by the changes of the makeup flowrates.

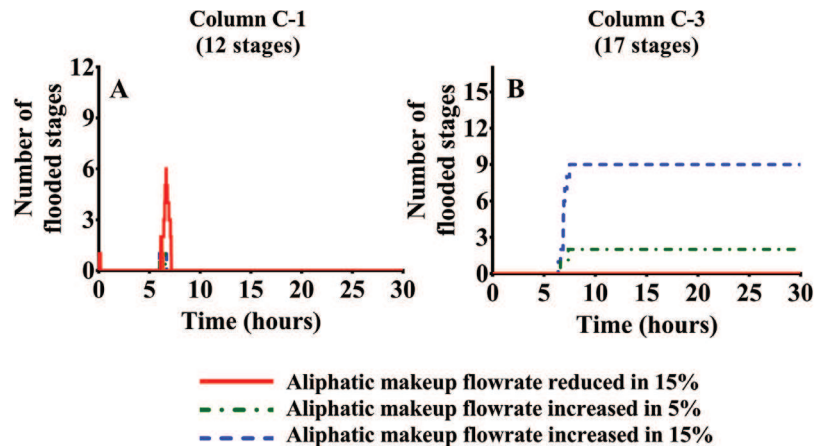

Fig. 9. Influence of the makeup flowrates variation on the column flooding (C-1 and C-3).

flowrates of the downstream equipment are determined by the vapor-liquid equilibria inside the column with the deviation. This result can be observed in Fig. 10, which shows the variations of the thermal loads that are predicted by the dynamic simulations. For this purpose, Fig. 10A–C show the ratio between the heat transferred in each condenser (Q_{cond}) and its initial steady-state value (Q_{cond}^*). Likewise, Fig. 10D to F show the ratio between the heat transferred in each reboiler (Q_{reb}) and its initial steady-state value (Q_{reb}^*).

In accordance with the heat transfer variations, the dynamic response observed in each scenario is described as follows:

- **Scenario 5:** The coolant flowrate is reduced in C-1 from 29,132 to 5826 kg hr⁻¹ (–80% in Fig. 10A). The effects are not completely corrected by the action of the temperature controllers of the distillation columns. The control of the column C-1 immediately reduces the steam temperature in order to regulate the temperature profile of the column. However, the deviation

remains during the rest of the simulation time, which also implies a continuous overheating in the column. Both contrary effects induce the periodic oscillations that are observed in Fig. 10D. This phenomenon affects the temperature and composition of the products of the column, which causes the propagation of the periodic behavior to the other two columns (Fig. 10B and C and E and F). However, the amplitude is inferior in these columns due to the action of more control loops through the main streams of the process.

- **Scenario 6:** The coolant flowrate is reduced in C-2 from 195,664 to 39,133 kg hr⁻¹ (–80% in Fig. 10B). In consequence, the upstream and downstream columns are affected since the heat transfer is notably reduced in C-1 and slightly increased in C-3. This fact corroborates again the high interactivity level of the system that is caused by the recycle stream of the system. The reduction of the separation level of the column affects the makeup flowrates of benzene and aliphatic hydrocarbons. In fact, the decrease of the heat transfer in C-2 is associated

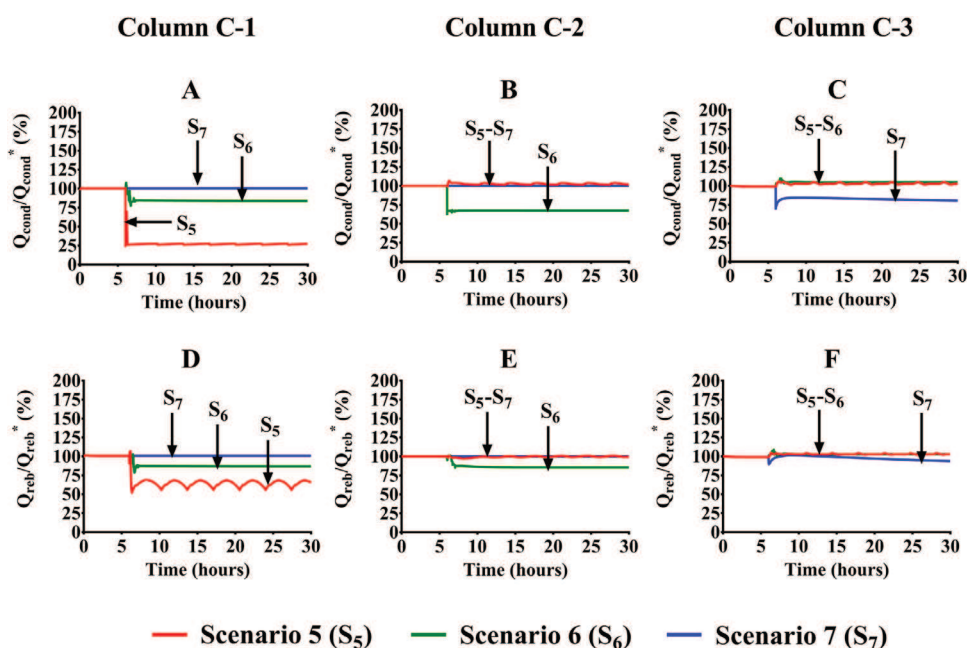

Fig. 10. Heat transfer variations occurred after the coolant flowrate reduction in one of the distillation columns.

with a reduction of the benzene fed to the column, which also reduces the propene dilution in the reacting mixture. This abnormal condition enhances the reaction rate (pseudo first-order kinetics) but diminishes the cumene selectivity. This increase of the diisopropylbenzene production explains the increase of the thermal loads in C-3.

- **Scenario 7:** The coolant flowrate is reduced in C-3 from 42,165 to 8433 kg hr⁻¹ (~80% in Fig. 10C). The effects of this deviation on the thermal loads of the separation equipment are negligible in the upstream columns in spite of this reduction. Thus, the system only manipulates the steam temperature in C-3 to regulate the temperature profile of this column.

The simulation results discussed above show that the deviations of the condensers of C-1 and C-2 involve greater risks than the C-3 condenser deviation due to their high propagation levels. This result can be explained by considering the flowrate profiles shown in Fig. 11.

The main issues emerged from the failures of the condensers of C-1 and C-2 are associated with the undesired feed of propene to the column C-2 (bottoms of C-1) and benzene to the column C-3 (bottoms of C-2). These abnormal conditions imply the presence of light hydrocarbons in the low-pressure equipment. This fact deteriorates the performance and separation efficiency of the distillation columns in both scenarios. However, the controllability of the thermal loads after the deviation of the C-1 condenser indicates a different dynamic response for the benzene flowrate at the bottoms of C-2. The C-1 condenser has a periodic behavior whereas the deviation in C-2 defines a sustained increase. In consequence, both scenarios differ notably regarding the severity magnitude. The difference of the severity levels of both scenarios can be illustrated in Fig. 11 with the variations of the reagents flowrates. The middle column of this chart shows that the benzene and propene flowrates have a drastic decrease after the occurrence of the deviation in C-2. Obviously, the distillate of C-2 has an important reduction in its flowrate that cannot be compensated by the flow control of the reactor feed. This result explains the reduction of the thermal loads that is discussed above (Fig. 10).

Moreover, the flowrate variations through the process can result in certain hazardous events associated with the liquid contain-

ment in other vessels of the separation unit. For instance, Fig. 12A-C show that the reduction of the coolant flowrate of a condenser causes an immediate decrease of the liquid level in the corresponding reflux drum. This fact results in the damage of the reflux pump due to an insufficient liquid feed rate. In the same manner, the sumps of C-1 and C-2 have a slight level increase (Fig. 12D and E) whereas the sump of C-3 is completely filled (Fig. 12F). This fact induces an overflowing at the bottom of the column that reaches the inlet nozzle of vapor coming from the reboiler. These issues confirm the necessity of setting up high-level and low-level alarms in the reflux drums and the bottoms of the distillation columns.

This result illustrates the necessity of implementing a set of protection layers in the distillation columns. The departure from normal conditions of the liquid levels, temperature or pressure activates the corresponding alarm in order to alert the operator. However, greater deviation levels require the action of override systems to maintain the process operation. In this case, safety barriers such as the activation of redundant equipment or utilities to increase reliability can be added. Additionally, the interlock shutdown systems can be included in order to avoid events that affect the integrity of the system. These protection layers are not the subject of this paper. However, their sizing will be part of a complementary study.

5.2. Vent releases in the distillation columns

The severity of the three simulated scenarios can also be discriminated by the overpressure levels reached in the distillation columns. The dynamic responses of these process variables can be described as follows:

- **Scenario 5:** The deviation immediately causes an overpressure in the three distillation columns. The overpressures of the simulated scenario are characterized by a periodic behavior in each one of the separation equipment. Fig. 13A shows that the major increase (2.5 bar) is established in the column with the deviation whose top stage overcomes the set pressure of the process safety valve (14.4 bar). In accordance with this result, Fig. 14A indicates a high vent release in this tower after the occurrence of the deviation that is followed by periodic smaller

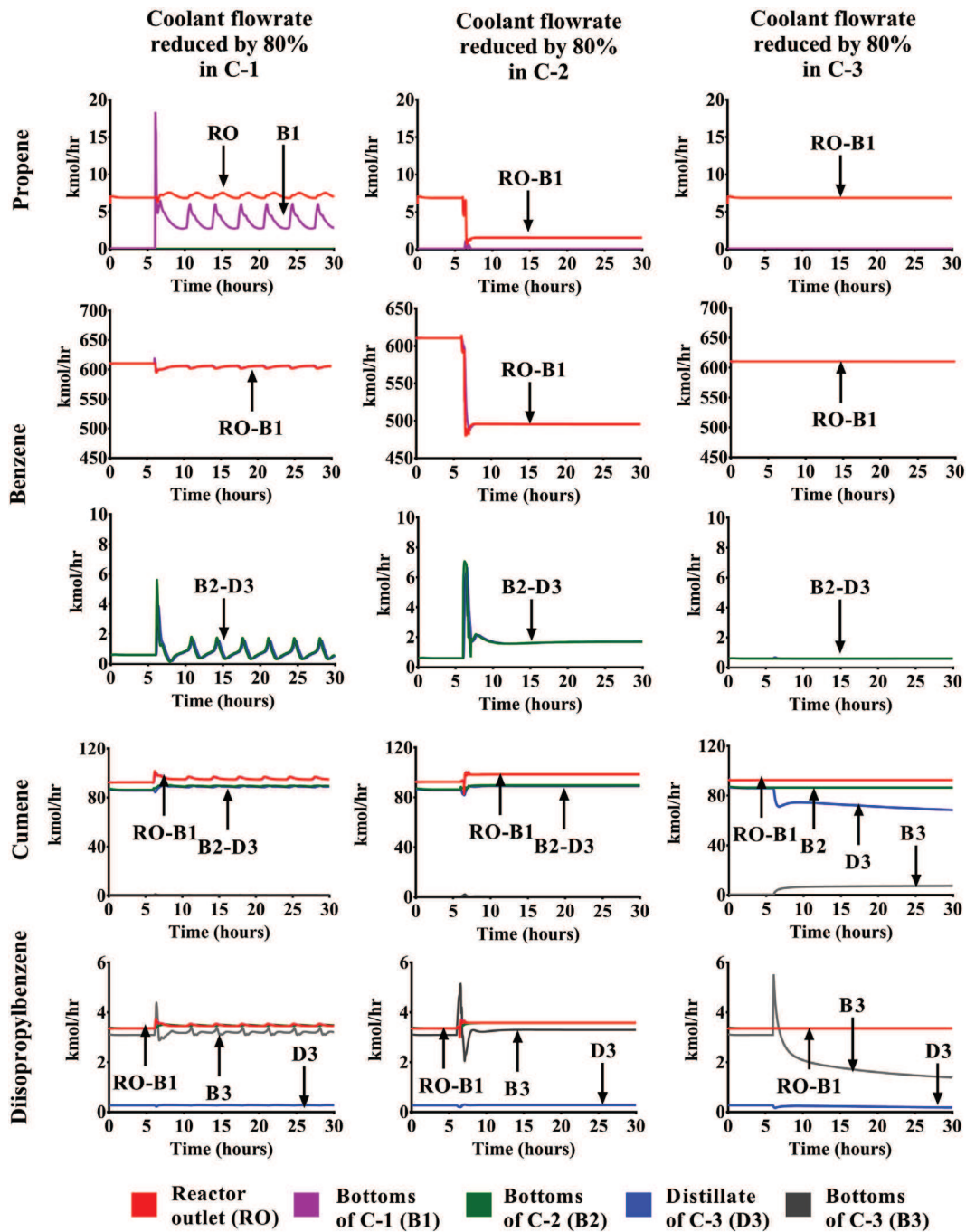

Fig. 11. Influence of the coolant flowrate reductions on the molar flowrates.

vent releases. On the contrary, the other columns have pressure increases below 0.5 bar. During the simulation, the maximum overpressures of C-1 and C-2 are below the set pressures of their relief devices. Therefore, the simulation does not predict any vent release for these columns in this scenario.

- Scenario 6:** Fig. 13B shows that the reduction of the heat removal in the condenser of C-2 has a similar effect as the deviation in C-1 during the first 2.3 h of abnormal operation. Thereafter, the vent flowrate becomes steady as well as the overpressure level at the top of the column (Fig. 14B). This result is observed because the column is designed to remove the unreacted benzene. The analysis of the vent flowrate defines this deviation as the most severe scenario due to the continuous hydrocarbon leakage at the top of C-2. This fact underlines that a process

safety valve is not enough to prevent a hazardous overpressure caused by a failure in the condenser. Therefore, it is necessary to implement a complementary safety barrier to avoid the sustained feed to the column C-2. Generally, an emergency interlock shutdown is added to cut the feed to the chemical reactor (Kister, 1990).

- Scenario 7:** Fig. 13C shows that the deviation occurred in the column C-3 causes an overpressure with a lower severity with regard to the two previous scenarios. In fact, the maximum pressure at the top of C-3 just reaches the set pressure (2.0 bar). Thus, the valve position of the process safety valve only shows a low opening during a short time lapse. Moreover, this scenario only predicts an overpressure in C-3. Since the column

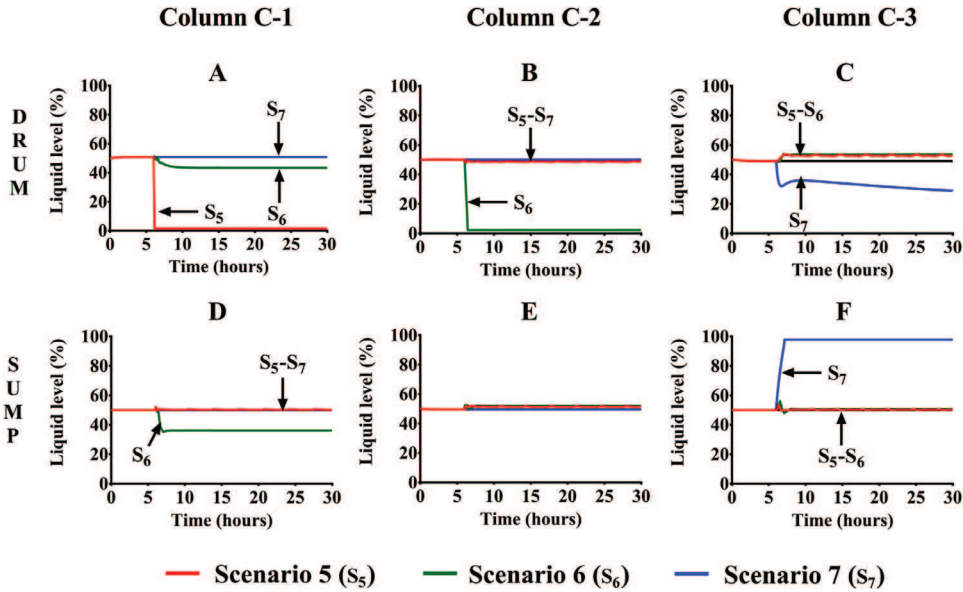

Fig. 12. Influence of the coolant flowrates reductions on the liquid levels in the reflux drums and sumps.

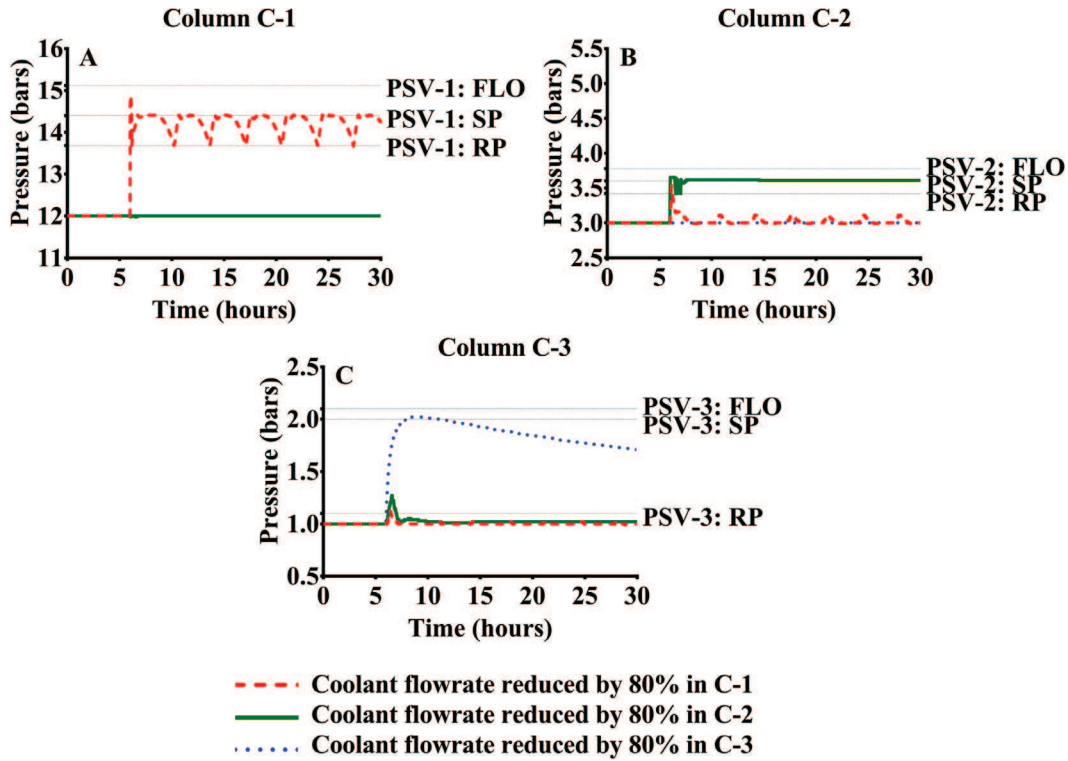

Fig. 13. Pressure increase in the distillation columns after the coolant flowrate reduction in one of the condensers FLO: full-lift opening pressure SP: set pressure RP: reseating pressure.

C-3 is out of the recycle loop, the deviation effects do not have interactive consequences on the other columns.

6. Loss of heating in an upstream column (scenarios 8 & 9)

In this part, the loss of heating in an upstream column is studied. This deviation has been previously discussed in the research work of Kister (1990). This author shows that the reduction of the heating efficiency in a distillation tower can induce an over-pressure in downstream equipment. This fact is due to the significant decrease of the vapor flowrate in the upstream column, which

reduces its liquid holdup and generates its weeping or dumping. Thereafter, the pressure drop of this column is considerably affected along with the separation efficiency of the equipment. In consequence, the feed rate of downstream equipment, as well as the fraction of light compounds entering to it, are submitted to a drastic increase. The occurrence of this event may increase excessively the pressure of the downstream distillation columns because of the presence of light hydrocarbons in the low-pressure separation equipment. The propagation effects associated with this deviation are considered in this section through two scenarios:

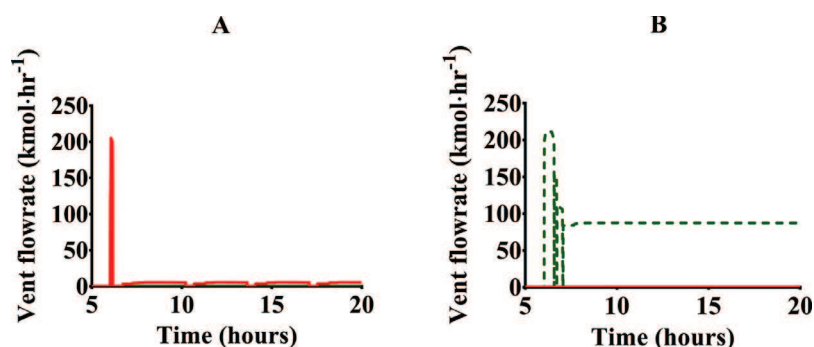

Fig. 14. Vent flowrates generated by the coolant flowrate reduction in one of the condensers A. Column C-1 (Scenario 5) B. Column C-2 (Scenario 6).

- Scenario 8: Steam temperature decreased by 15°C in C-1
- Scenario 9: Steam temperature decreased by 15°C in C-2

6.1. Effects on the performance of the distillation columns

The analysis of the propagation effects of the simulated scenarios is initially based on the comparison of the flowrate profiles with those of the steady-state operation. For this purpose, the simulation results shown in Fig. 15 are considered to describe the different dynamic responses of the chemical process:

- **Scenario 8:** The variation of the steam temperature constitutes a permanent reduction of 12% in the heat transfer of the reboiler of C-1. The effects of this deviation are shown in the left column of Fig. 15. This deviation induces a temperature diminution in the column. As a result, the aliphatic compounds concentrate at the bottom of the column instead of the distillate. For this reason, an important increase of the propene flowrate in the bottoms stream (0 to 12 kmol hr⁻¹) can be observed in Fig. 15A. In addition, the results underline that the propagation of this deviation also increases the flowrate of this hydrocarbon from 6 to 13 kmol hr⁻¹ at the outlet of the packed bed reactor. Therefore, it is possible to identify a magnified effect in the propagation through C-1 since a poor propene separation is accompanied by a higher propene feed rate. This abnormal operation can be considered as a severe condition since the bottoms propene flowrate should be approximately zero. The variations of the propene flowrates have a direct impact on the benzene flowrates (Fig. 15B and G). Evidently, the aliphatic hydrocarbons fed to C-2 are recovered at the top of the column. This fact implies a lower benzene recovery in the distillate of this tower along with the increase of its concentration in the bottoms stream. In consequence, a high amount of benzene is temporarily fed to the column C-3 and the benzene makeup flowrate diminishes permanently. Finally, Fig. 15J and M show that the flowrates variations of the alkylated hydrocarbons are not significant. The rise of the benzene feed to C-3 increases temporarily the amount of cumene in the bottoms of C-3. However, this propagation effect is not permanent due to the action of the controllers. Therefore, the production of cumene and diisopropylbenzene does not present significant changes.
- **Scenario 9:** The variation of the steam temperature constitutes a temporary reduction of 5.5% in the heat transfer of the reboiler of C-2. The effects of this deviation are shown in the right column of Fig. 15. This scenario differs notably from the scenario 8 because the deviation propagation only has an important effect on one of the columns. This result can be observed by comparing Fig. 15G with I. The reduction of the steam temperature in C-1 causes a temporary increase of the benzene flowrate at the bottoms of C-2. However, the reduction of the steam in C-2 column makes it permanent. These simulation re-

sults allow establishing that the system is capable to regulate the benzene flowrate in B2 when the failure is in C-1 but not when it is in C-2. Additionally, scenario 9 does not constitute a significant variation of the propene flowrates. This result illustrates that the location of the process deviation induces different issues in the chemical process operation. Evidently, the presence of a recycle stream constitutes a mitigation factor for the benzene flowrate regulation and a propagation factor for the propene flowrate.

Furthermore, the response of the column flooding factors in scenarios 8 and 9 is similar to that observed in the makeup flowrate variations scenarios. These effects are shown in Fig. 16.

The simulation results show that the dynamic responses of the flooding factors of the distillation columns are determined by their position with regard to the origin of the process deviation. For this reason, the analysis of these key process variables is divided into the following categories:

- **Columns with the deviation:** Fig. 16A and E show that the loss of heating in a reboiler reduce the flooding factors of the stages of a distillation column that are located below the feed inlet in a distillation column whereas the upper stages have an increase. These effects correspond directly to the accumulation of the light hydrocarbons at the bottom of the column caused by the lower boiling rates in these columns.
- **Downstream columns:** Fig. 16B and F show that the behavior of the flooding variables in this equipment is mainly associated with the benzene feed rates. The temporary variation that is observed with the deviation in C-1 and the permanent variation that is observed in the deviation occurred in C-2 decrease the flooding factors of the downstream columns. These changes correspond to the reduction of the gas velocity through each distillation column. A priori, an increase of these factors would be expected due to the inlet of the light hydrocarbons. However, this is not the case because the densities of the rising vapors decrease because of the chemical compositions. In addition, the hydrocarbons that should be recovered in the distillates (benzene for C-2 and cumene for C-3) are now concentrated at lower stages. This fact represents an increase of the down-coming liquid flow as well. The characteristics that are discussed above are also observed in the last column (Fig. 16C). Therefore, it is possible to establish that the decrease of the flooding factors is observed with a lower intensity for the last equipment.
- **Upstream column:** In spite of the presence of a recycle stream in the chemical process, the flooding factors of the column C-1 are not significantly affected when the heating of the column C-2 is decreased (Fig. 16D).

The simulation results show that the column flooding should not be considered as a severe negative consequence of the two

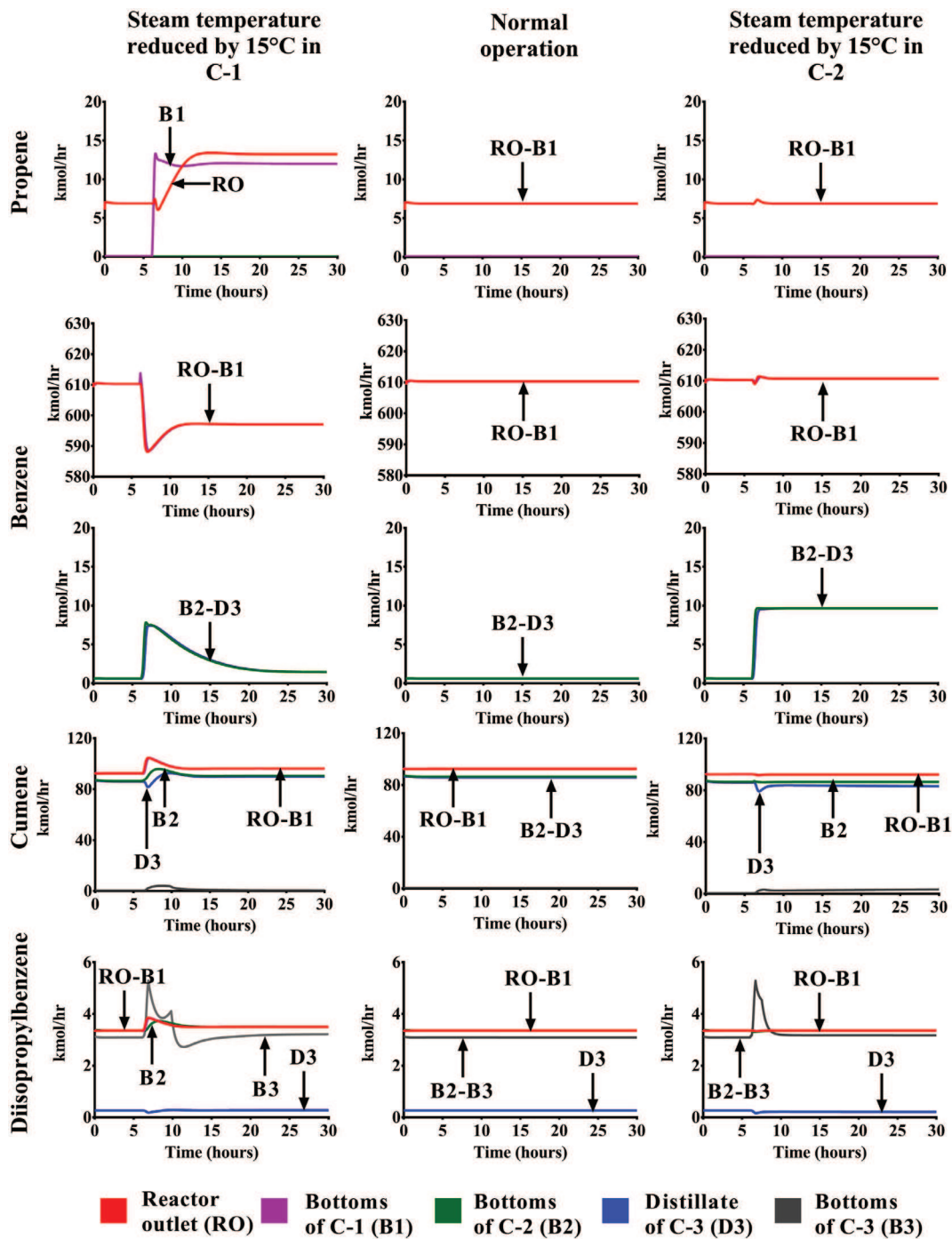

Fig. 15. Influence of the loss of heating in a distillation column on the molar flowrates.

considered scenarios. For this reason, this type of effects is mainly associated with the vent releases that are caused by the overpressures at the top of the separation equipment.

6.2. Vent releases in the distillation columns

The deviation propagations on the reagent flowrates induce different overpressure levels in the distillation columns. Initially, Fig. 17 shows that the deviation occurring in C-1 results in a permanent overpressure at the top of C-2 and a transient increase at the top of C-3. The overpressure emerged from the heating reduction in C-1 is associated with the permanent propene increase at the bottoms of C-1 and the transient benzene increase at the

bottoms of C-2. Similarly, the heating reduction in C-2 induces an overpressure in C-3 by the presence of benzene in its feed stream. However, both scenarios differ from each other since only the deviation in C-1 causes an overpressure that reaches the set pressure of a process safety valve (Fig. 17A). In consequence, the only hazardous event is triggered by the decrease of the heating steam temperature in C-1 (Fig. 18). The process safety valve PSV-2 is opened, which induces a vent release of hydrocarbons. This flowrate is continuously increasing due to the influence of the recycle stream. Indeed, the propene loss through the vent generates a decrease of the benzene makeup stream by the action of the feed control of the chemical reactor (BENZENE_FC). In consequence, an

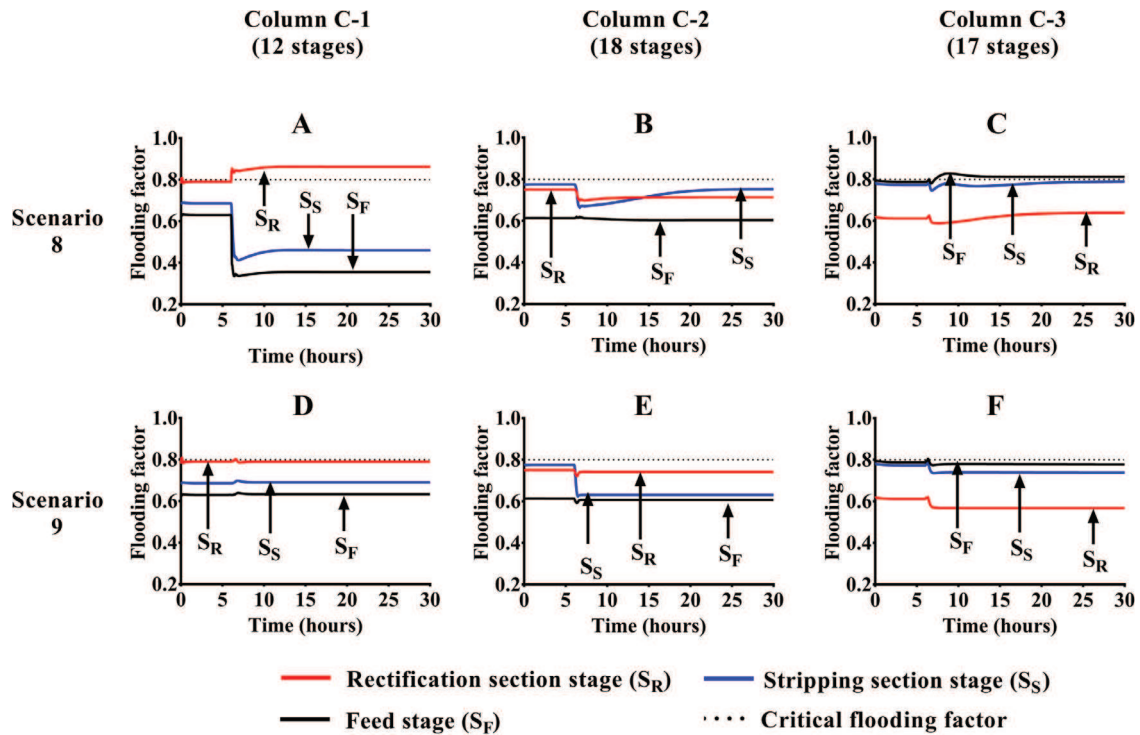

Fig. 16. Variations of the flooding factors of the distillation columns caused by the loss of heating in an upstream column.

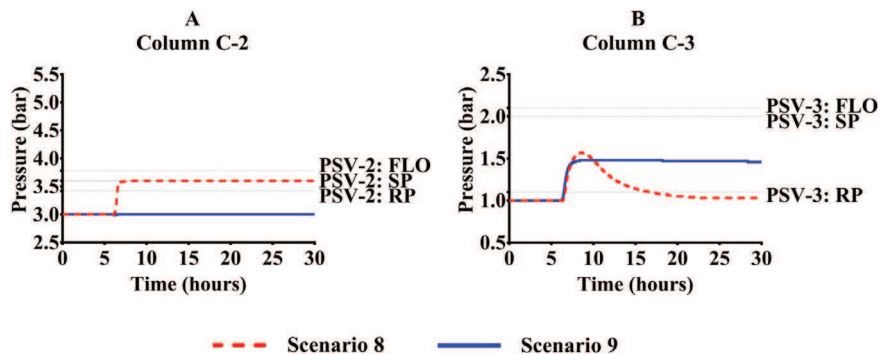

Fig. 17. Pressure increase of the distillation columns after the loss of heating in a distillation column FLO: full lift opening pressure SP: set pressure RP: reseating pressure.

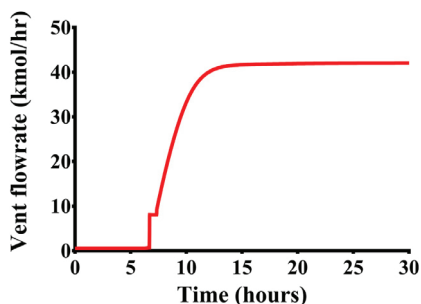

Fig. 18. Vent flowrate established in the column C-2 for the scenario 8.

additional amount of non-reacted propene will be vented through PSV-2 as well. This phenomenon will induce a snowball effect during the deviation propagation. This propene increase is low during the initial stage of the deviation (0.69 h after the occurrence of the deviation). Then, this escalating abnormal operation leads to a surge of propene from C-1 to C-2 that is observed through a 6% reduction of the distillate flowrate in C-1. Moreover, the increase

of the vent flowrate is also due to the hysteresis characteristics of PSV-2 (Fig. 3), which contributes to the discontinuity observed in Fig. 18.

This result establishes that this scenario must be prioritized over the deviation in C-2 due to its higher potential negative consequences. However, the loss of heating in C-2 also describes a pressure increase in the column C-3 (Fig. 17B). Thus, it is also necessary to consider this scenario in the risk assessment because a greater reduction of the steam temperature in C-2 may result in another vent release in the column C-3.

6.3. Effects of the deviation on the performance of the packed bed reactor

Fig. 19 shows that scenario 8 develops a new steady-state operation that is defined by a reduction of 5% in the conversion rate of propene and a decrease in the cumene/by-product ratio. Previously, it is discussed how this disturbance results in a higher feed rate of propene to the separation unit. In accordance with this statement, it is possible to analyze the propagation process by considering the factors that affect negatively the conversion in the packed bed re-

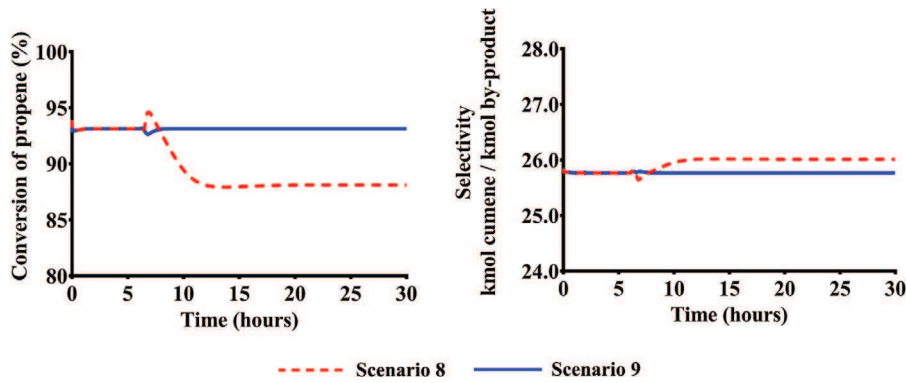

Fig. 19. Influence of the loss of heating in a distillation column on the conversion of propene and the selectivity of the reaction.

actor. The simulation results show that the presence of aliphatic hydrocarbons in the distillate of C-2 reduces the top temperature of this column from 120.8°C to 106.3°C. This fact diminishes the feed temperature of the reactor from 170°C to 161.3°C and therefore the kinetics of the chemical reaction is negatively affected. In this manner, it is possible to explain the synergic effect that is discussed above by considering the effects on the yield of the alkylation reactions.

Upstream the reactor the permanent temperature decrease of the streams indicates that the temperature and flow controls do not have a sufficient response to this type of deviations. The reactor feed remains at a low temperature even if the heating steam of the exchanger E-2 reaches the maximum manipulated pressure. This result is due to the propene flowrate increase and the new vapor-liquid equilibria of the column C-2. This abnormal operation can only be stabilized by a continuous vent and an excessive recycle of light hydrocarbons (Fig. 18).

7. Discussion of the process deviation results

The three types of simulation scenarios that are considered in this study differ notably in the severity and location of the negative effects associated with the propagation of the process deviations. For this reason, a risk assessment is carried out in order to rank the abnormal operation scenarios. Risk analysis is a decision-making tool that allows performing a tolerability judgment. This can be achieved by analyzing the evolution of an operating variable. For this study, the risks associated with flooding and overpressure phenomena are discussed. Scenarios 2 and 3 do not generate these risks. Thus, they are not considered in this section.

7.1. Pressure drop ratio

The pressure drop per meter in each distillation column (ΔP_r) is determined as the ratio between the pressure drop in the column (ΔP) and its height (H). This operating parameter determines a comparative basis of the flooding or weeping levels. For this reason, it is taken into account for the risk assessment of this study. The dynamic analysis considers the scheme shown in Fig. 20 to establish the maximum variation of the pressure drop ratio after the occurrence of the deviation (ΔP_r). Likewise, the analysis also determines the time that is required by the column to reach the maximum variation (Δt).

The responses of the three distillation columns to each process deviation are shown in Table 7 and Fig. 21. For instance, the major variations of the pressure drop ratio in the column C-1 are observed for the increase of the aliphatic flowrate and the reduction of the steam temperature in its reboiler. These behaviors agree with the surge of the flooding approaches in Fig. 8A as well as

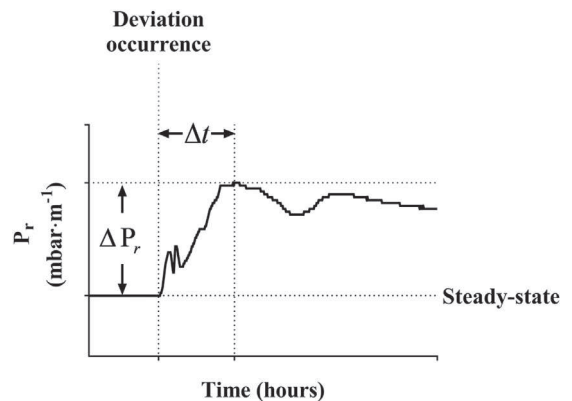

Fig. 20. Determination of the maximum deviation and its corresponding time lapse (Δt).

their rapid decrease in Fig. 16A. Similarly, this analysis can be extended for the analysis of consequences in the columns C-2 and C-3.

The risk assessment presented in this section evaluates the flooding or weeping risks emerged from all the deviations. For this purpose, a severity index is proposed with the following levels:

1. *Low severity index (value equal to 1):* Maximum variation of the pressure drop ratio lesser than 10% of the steady-state value.
2. *Medium severity index (value equal to 2):* Maximum variation of the pressure drop ratio between 10% and 20% of the steady-state value.
3. *High severity index (value equal to 3):* Maximum variation of the pressure drop ratio greater than 20% of the steady-state value.

Likewise, the dynamic response (Fig. 21) indicates the time period during which the propagations reach its maximum or minimum values. It also establishes the time period during which the operators can react effectively to the occurrence of a specific deviation (Berdouzi, 2017). For example, the increase of the aliphatic makeup flowrate reaches a pressure drop ratio of 5.3 mbar m^{-1} in the column C-1 after 39 min (0.65 h) of abnormal operation. The flooding phenomenon dynamics is taken into account with a second index whose levels are based on the time elapsed to reach the maximum variation:

1. *Slow dynamics index (value equal to 1):* Pressure drop peak value reached in more than 30 min (0.5 h) after the occurrence of the deviation.
2. *Moderate dynamics index (value equal to 2):* Pressure drop peak value reached between 10 min (0.17 h) and 30 min (0.5 h) after the occurrence of the deviation.

Table 7
Pressure drop ratio in each distillation column.

Deviation	C-1		C-2		C-3	
	ΔP_r (mbar·m ⁻¹)	Δt (hours)	ΔP_r (mbar·m ⁻¹)	Δt (hours)	ΔP_r (mbar·m ⁻¹)	Δt (hours)
Scenario 1	5.32	0.65	3.85	1.54	2.11	15.65
Scenario 4	3.76	0.34	3.37	1.38	4.35	5.62
Scenario 5	2.97	0.43	3.10	0.08	3.80	1.12
Scenario 6	3.27	0.78	1.94	0.72	3.70	6.09
Scenario 7	4.30	-	3.59	-	2.17	0.14
Scenario 8	3.27	0.40	3.29	1.32	3.79	2.68
Scenario 9	4.37	0.98	3.22	0.38	3.61	0.35

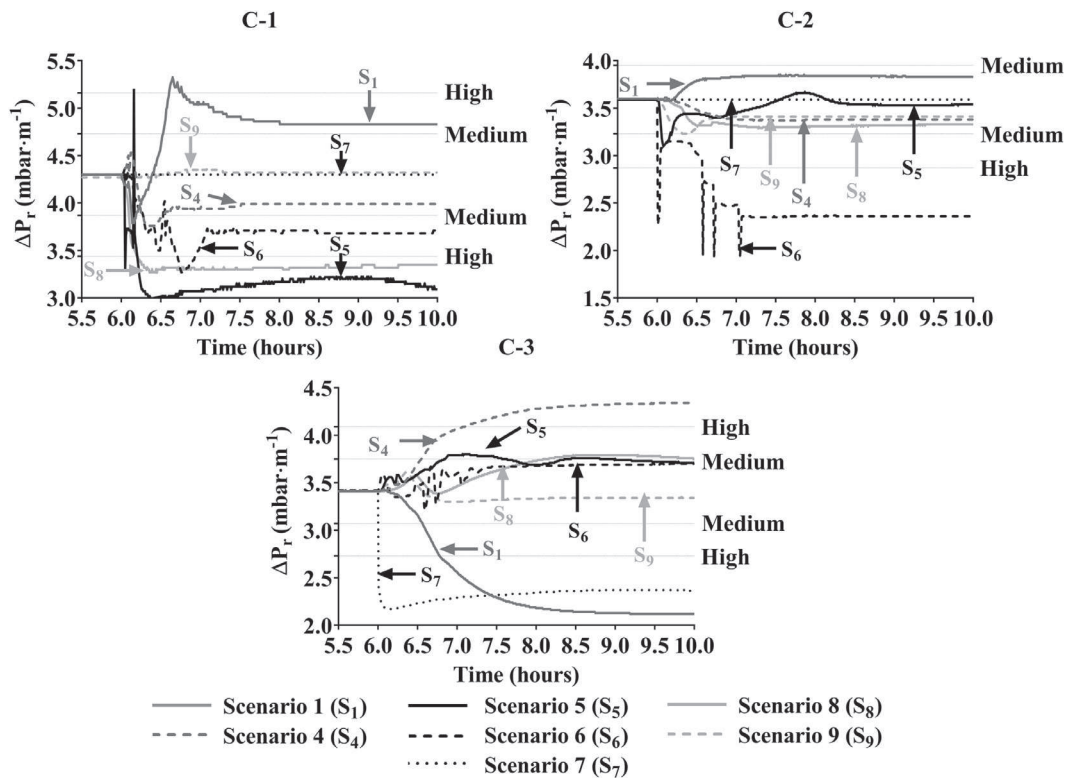

Fig. 21. Variations of the pressure drop per meter generated by the process deviations.

Table 8
Flooding risk assessment risk levels: low or slow (normal) – medium or moderate (italic) – high or quick (bold).

Deviation	C-1			C-2			C-3		
	Severity index	Dynamics index	Risk index	Severity index	Dynamics index	Risk index	Severity index	Dynamics index	Risk index
Scenario 1	3	1	3	1	1	1	3	1	3
Scenario 4	2	2	4	1	1	1	3	1	3
Scenario 5	3	2	6	2	3	6	2	1	2
Scenario 6	3	1	3	3	1	3	1	1	1
Scenario 7	1	1	1	1	1	1	3	3	9
Scenario 8	3	2	6	1	1	1	2	2	2
Scenario 9	1	1	1	2	2	4	1	2	2

3. *Quick dynamics index (value equal to 3)*: Pressure drop peak value reached in less than 10 min (0.17 h) after the occurrence of the deviation.

Table 8 lists the risk indexes estimated for this case study according to the pressure drop ratios and the response times. The risk levels prioritize the simulation scenarios that have drastic changes in the mechanical performance of the distillation columns. The scenario ranking shown in **Table 8** is based on a risk index, which corresponds to the multiplication of the severity and dy-

namics indexes. This index allows classifying the risk according to the following criteria:

1. *Low-level risk*: Risk index between 1 and 3.
2. *Medium-level risk*: Risk index between 4 and 6.
3. *High-level risk*: Risk index between 7 and 9.

The classification based on the maximum and minimum values includes a majority of the scenarios into the medium and high-level risks. For example, the analysis of the column C-1 also allows considering the reductions of the coolant flowrates in the column C-1 and C-2 as high-level risk situations in spite of their short du-

Table 9

Comparison of the vent releases generated by the most severe scenario of each process deviation risk levels: low (normal) – medium (italic) – high (bold).

Deviation	C-1			C-2			C-3		
	Overpressure (bar)	Max. vent flowrate	Risk index	Overpressure (bar)	Max. vent flowrate	Risk index	Overpressure (bar)	Max. vent flowrate	Risk index
Scenario 1	–	–	1	–	–	1	–	–	1
Scenario 4	–	–	1	–	–	1	<i>0.34</i>	–	2
Scenario 5	2.89	204.8	3	<i>0.53</i>	–	2	<i>0.12</i>	–	2
Scenario 6	–	–	1	0.65	211.3	3	<i>0.27</i>	–	2
Scenario 7	–	–	1	–	–	1	1.02	1.0	3
Scenario 8	–	–	1	0.60	42.0	3	<i>0.57</i>	–	2
Scenario 9	–	–	1	–	–	1	<i>0.48</i>	–	2

ration or minor effects on the operation of the column. In accordance with the total risk indexes, the major risk associated with the operating stability of the distillation equipment is observed for the coolant flowrate reduction in C-3 (scenario 7). This criterion provides a better scenario description since it takes into account the chemical process dynamics.

7.2. Column overpressure and vent release

The previous section shows that the consequences of the propagation of a process deviation are determined by its capacity to affect the internal vapor flowrates of the distillation columns. Thus, it is also possible to prioritize the scenarios according to a risk analysis based on the column overpressure. In this study, a classification is proposed according to the data listed in Table 9, which compares the scenarios that develop the highest overpressure in the three types of deviations. The risk index is defined in this case according to the following criteria:

1. Low-level overpressure risk (value equal to 1): No overpressure in the distillation column.
2. Medium-level overpressure risk (value equal to 2): Insufficient overpressure to open the process safety valve.
3. High-level risk overpressure (value equal to 3): Overpressure that activates the PSV opening.

The results indicate that the highest overpressure levels are due to the cooling system malfunctions whereas the minor effects are mainly associated with the changes in the compositions of the reactor feed. This result establishes a greater risk level for the coolant flowrate reduction since it constitutes the major instantaneous vent release. Therefore, it represents a greater potential to form an explosive atmosphere due to hydrocarbons accidental leakage.

This comparative analysis can be extended to any simulated scenario in order to provide a detailed comparison of the propagation factors and the negative effects of each process deviation. As a result, the subjectivity in the determination of the hazardous event severity and likelihood during a HAZOP analysis can be diminished (Isimite and Rubini, 2016). In this manner, the simulation results can provide the necessary predictive information that allows evaluating the response of a control structure and the pressure relief devices.

8. Conclusions

This work shows that the dynamic simulation is an interesting tool to study the propagation of process deviation, useful and essential for process risk assessment. The goal of this research work is to assess the magnitude and dynamics of the deviation effects. The feasibility of this methodology is demonstrated through the simulation of a complex case study. The simulation results are directly linked to the sizing and control strategies. Therefore, the dynamic response to each deviation is obviously associated with

these simulation settings. That is why it is important to establish an appropriate representation of the system. Thus, an experimental study in normal and degraded modes is also necessary to validate the system model.

We have implemented the dynamic simulation methodology on benzene alkylation process, which is composed of a reactor and a set of three distillation columns connected by a recycle stream. Thereafter, we study the deviation propagation along this process. Based on lessons learnt from previous accidents, we focus on deviations that can result in a pressure increase of the distillation columns.

The simulation results put in evidence the deviation propagation effects through the alkylation reactor and the distillation columns. The simulation scenarios identify the abnormal conditions in which an overpressure is feasible as well as the flowrate profiles of the eventual vent releases. The deviations can result in a periodic or permanent overpressure if the mitigation system does not include a complementary safety system. This additional control must respond directly to the disturbance or stop completely the operation of the chemical process. Thus, it is compulsory to take into account the main characteristics of the feasible process deviations as well as the operating conditions of an industrial process during the determination of the required safety barriers.

Moreover, the recycle stream can be a propagation factor in accordance with the characteristics of the manufacturing process. For instance, the reduction of the steam temperature on the reboiler of the column C-2 does not have any significant effect on the upstream equipment. On the contrary, the reduction of this variable in C-1 constitutes not only the overpressure of the downstream distillation columns but also a decrease of 5% on the propene conversion to cumene.

Finally, the comparison of the simulation results is considered to propose a scenario classification based on the most severe effects that are observed in the dynamic simulations of the chemical process. In accordance with this criterion, the case study defines the drastic decrease of the coolant flowrate in a condenser as the most critical event whereas the changes of the makeup streams represent the minor negative effects. Nonetheless, the latter scenario must also be considered because it describes an excessive flooding in the columns. For this reason, the negative effects should always be determined for each process unit in the dynamic analyses in order to establish properly all the risks caused by the deviation propagation.

Of course, this methodology should be applied to other deviations, in order to be able to prioritize scenarios that can result in an industrial accident. This work contributes to the definition of the worst-case scenarios and the required safety barriers. The simulation tool can determine globally the potential effects of a process variation and provide predictive information to validate the nature and the sizing of safety barriers. The validation step consists in checking that the residual risk that remains after the action of safety barriers is acceptable.

References

- API 520-I, 2008. API 520 Sizing, Selection, and Installation of Pressure Relieving Devices in Refineries, Part I - Sizing and Selection. API Standard 520.
- ARIA, 2016. Base de données du Ministère de l'Ecologie et du Développement Durable Français Retrieved December 16, 2016, from <http://www.aria.developpement-durable.gouv.fr/>.
- Bellussi, G., Pazzuconi, G., Perego, C., Girotti, G., Terzoni, G., 1995. Liquid-phase alkylation of benzene with light olefins catalyzed by β -zeolites. *J. Catal.* 157 (1), 227–234.
- Berdouzi, F., 2017. Simulation Dynamique de Dérives de Procédés Chimiques Application à l'Analyse Quantitative des Risques Retrieved from PhD thesis. Université de Toulouse, Toulouse.
- Berdouzi, F., Olivier-Maget, N., Gabas, N., 2016. Using dynamic simulation for risk assessment: application to an exothermic reaction. In: Z. K., Bogataj, M. (Eds.). In: *Computer Aided Chemical Engineering*, Vol. 38. Elsevier, pp. 1563–1568.
- Bezzo, F., Bernardi, R., Cremonese, G., Finco, M., Barolo, M., 2004. Using process simulators for steady-state and dynamic plant analysis. *Chem. Eng. Res. Design* 82 (4), 499–512.
- Bodizs, L., Hahn, M., Rix, A., Schallenberg, J., 2015. Dynamic models for safety shutdown of distillation columns. *Chem. Eng. Res. Design* 99, 208–214.
- Corma, A., Corell, C., Pérez-Pariente, J., 1995. Synthesis and characterization of the MCM-22 zeolite. *Zeolites* 15 (1), 2–8.
- Corma, A., Martínez-Soria, V., Schnoefeld, E., 2000. Alkylation of benzene with short-chain olefins over MCM-22 zeolite: catalytic behaviour and kinetic mechanism. *J. Catal.* 192 (1), 163–173.
- Dimian, A., Bildea, C.S., 2008. *Chemical Process Design: Computer-Aided Case Studies*. Wiley.
- Ebrahimzadeh, E., Baxter, L.L., 2016. Plant-wide control of coupled distillation columns with partial condensers. *Appl. Therm. Eng.* 102, 785–799.
- Etchells, J., Wilday, J., 1998. *Workbook for Chemical Reactor Relief System Sizing*. HSE Books.
- Gabbar, H.A., Shinohara, S., Shimada, Y., Suzuki, K., 2003. Experiment on distributed dynamic simulation for safety design of chemical plants. *Simul. Modell. Pract. Theory* 11 (2), 109–123.
- Gera, V., Panahi, M., Skogestad, S., Kaistha, N., 2013. Economic plantwide control of the cumene process. *Ind. Eng. Chem. Res.* 52 (2), 830–846.
- Gorak, A., Schoenmakers, H., 2014. *Distillation: Operation and Applications*. Academic Press.
- Gustin, J.-L., 2006. Calcul d'événements : méthodes du DIERS - Gassy Reactions, 22.
- Gustin, J.-L., 2009. Calcul d'événements. Méthodes du DIERS - Systèmes hybrides, 25.
- Ingham, J., Dunn, I., Heinzle, E., Prenosil, J., Snape, J., 2007. *Chemical Engineering Dynamics: An Introduction to Modelling and Computer Simulation*. John Wiley & Sons, Inc.
- Isimite, J., Rubini, P., 2016. A dynamic HAZOP case study using the Texas City refinery explosion. *J. Loss Prevent. Process Ind.* 40, 496–501.
- Kalantarnia, M., Khan, F., Hawboldt, K., 2010. Modelling of BP Texas City refinery accident using dynamic risk assessment approach. *Process Saf. Environ. Protect.* 88 (3), 191–199.
- Kister, H., 1990. *Distillation Operation*. McGraw Hill Professional.
- Kister, H.Z., 2003. What caused tower malfunctions in the last 50 years? *Chem. Eng. Res. Des.* 81 (1), 5–26.
- Kister, HenryZ., 1997. Are column malfunctions becoming extinct—or will they persist in the 21st century? *Chem. Eng. Res. Des.* 75 (6), 563–589.
- Kletz, T.A., 2009. *What Went Wrong? - (Fifth Edition)* - ScienceDirect, fifth ed. Butterworth-Heinemann.
- Labovský, J., Švandová, Z., Markoš, J., Jelemenský, L., 2007. Model-based HAZOP study of a real MTBE plant. *J. Loss Prevent. Process Ind.* 20 (3), 230–237.
- Luyben, W.L., 2006. *Distillation Design and Control using Aspen™ Simulation*. John Wiley & Sons, Inc.
- Luyben, W.L., 2010. Design and control of the cumene process. *Ind. Eng. Chem. Res.* 49 (2), 719–734.
- Luyben, W.L., 2012a. Rigorous dynamic models for distillation safety analysis. *Comput. Chem. Eng.* 40, 110–116.
- Luyben, W.L., 2012b. Use of dynamic simulation for reactor safety analysis. *Comput. Chem. Eng.* 40, 97–109.
- Manca, D., Brambilla, S., 2012. Dynamic simulation of the BP Texas City refinery accident. *J. Loss Prevent. Process Ind.* 25 (6), 950–957.
- Murillo, C., Berdouzi, F., Olivier-Maget, N., Gabas, N., 2017. Deviation propagation analysis along an industrial process by using dynamic simulation. *Récents Progrès En Génie Des Procédés* 110.
- Smith, C.A., Corripio, A.B., 1985. *Principles and Practice of Automatic Process Control*. Wiley, New York.
- Smith, R., 2016. *Chemical Process: Design and Integration*, second ed. Wiley, Chichester, West Sussex, United Kingdom.
- Tian, W., Du, T., Mu, S., 2015. HAZOP analysis-based dynamic simulation and its application in chemical processes: HAZOP based dynamic simulation. *Asia Pacific J. Chem. Eng.* 10 (6), 923–935.
- Treybal, R.E., 1980. *Mass-Transfer Operations*, third ed. McGraw-Hill Book Company, México etc.
- US Chemical Safety Board, 2007. *BP Texas City Accident Report*.
- Wang, Y., Zhang, Z., Xu, D., Liu, W., Zhu, Z., 2016. Design and control of pressure-swing distillation for azeotropes with different types of boiling behavior at different pressures. *J. Process Control* 42, 59–76.