



HAL
open science

Structure, function and regulation of *Pseudomonas aeruginosa* porins

Sylvie Chevalier, Emeline Bouffartigues, Josselin Bodilis, Olivier Maillot, Olivier Lesouhaitier, Marc Feuilloley, Nicole Orange, Alain Dufour, Pierre Cornelis

► **To cite this version:**

Sylvie Chevalier, Emeline Bouffartigues, Josselin Bodilis, Olivier Maillot, Olivier Lesouhaitier, et al.. Structure, function and regulation of *Pseudomonas aeruginosa* porins. *FEMS Microbiology Reviews*, 2017, 41 (5), pp.698 - 722. 10.1093/femsre/fux020 . hal-01886554

HAL Id: hal-01886554

<https://hal.science/hal-01886554v1>

Submitted on 18 Oct 2024

HAL is a multi-disciplinary open access archive for the deposit and dissemination of scientific research documents, whether they are published or not. The documents may come from teaching and research institutions in France or abroad, or from public or private research centers.

L'archive ouverte pluridisciplinaire **HAL**, est destinée au dépôt et à la diffusion de documents scientifiques de niveau recherche, publiés ou non, émanant des établissements d'enseignement et de recherche français ou étrangers, des laboratoires publics ou privés.

REVIEW ARTICLE

Structure, function and regulation of *Pseudomonas aeruginosa* porins

Sylvie Chevalier^{1,*}, Emeline Bouffartigues¹, Josselin Bodilis¹, Olivier Maillot¹, Olivier Lesouhaitier¹, Marc G. J. Feuilloley¹, Nicole Orange¹, Alain Dufour² and Pierre Cornelis¹

¹Laboratory of Microbiology Signals and Microenvironment LMSM EA 4312, University of Rouen, Normandy University, 27000 Evreux, France and ²IUEM, Laboratoire de Biotechnologie et Chimie Marines EA 3884, Université de Bretagne-Sud (UEB), 56321 Lorient, France

*Corresponding author: Laboratory of Microbiology Signals and Microenvironment LMSM EA 4312, University of Rouen, Normandy University, 55, rue St Germain, 27000 Evreux, France. Tel: +02-32-29-15-60; E-mail: sylvie.chevalier@univ-rouen.fr

One sentence summary: Porins of *Pseudomonas aeruginosa* play numerous important functions and their expression seems to be highly regulated, reflecting their involvement in the bacterial adaptability to evolving environmental conditions.

Editor: Alain Filloux

ABSTRACT

Pseudomonas aeruginosa is a Gram-negative bacterium belonging to the γ -proteobacteria. Like other members of the *Pseudomonas* genus, it is known for its metabolic versatility and its ability to colonize a wide range of ecological niches, such as rhizosphere, water environments and animal hosts, including humans where it can cause severe infections. Another particularity of *P. aeruginosa* is its high intrinsic resistance to antiseptics and antibiotics, which is partly due to its low outer membrane permeability. In contrast to Enterobacteria, pseudomonads do not possess general diffusion porins in their outer membrane, but rather express specific channel proteins for the uptake of different nutrients. The major outer membrane 'porin', OprF, has been extensively investigated, and displays structural, adhesion and signaling functions while its role in the diffusion of nutrients is still under discussion. Other porins include OprB and OprB2 for the diffusion of glucose, the two small outer membrane proteins OprG and OprH, and the two porins involved in phosphate/pyrophosphate uptake, OprP and OprO. The remaining nineteen porins belong to the so-called OprD (Occ) family, which is further split into two subfamilies termed OccD (8 members) and OccK (11 members). In the past years, a large amount of information concerning the structure, function and regulation of these porins has been published, justifying why an updated review is timely.

Keywords: *Pseudomonas aeruginosa*; porins, OprF; regulation; virulence; outer membrane

INTRODUCTION

Pseudomonas aeruginosa is the best known and investigated member of the genus *Pseudomonas*, the representatives of which are known for their high metabolic versatility. *Pseudomonas syringae* pathovars are important plant pathogens while *P. aeruginosa* causes infections in immunocompromised individuals and in cystic fibrosis (CF) patients (Goldberg 2000; Lyczak, Cannon

and Pier 2000). Being a Gram-negative bacterium, *P. aeruginosa* has a cytoplasmic membrane with a symmetric phospholipid bilayer and an asymmetric outer membrane with a phospholipid inner face and a lipopolysaccharide outer layer, which generates a permeability barrier. The outer membrane of *P. aeruginosa* contains numerous proteins, including lipoproteins and channels (Remans et al. 2010). Exchange of nutrients across the outer

membrane is orchestrated by β -barrel proteins producing water-filled diffusion channels, which give these membranes a molecular sieve-like appearance. These channels were first termed porins, given their pore shape and function, and were characterized by electron microscopy and conductance measurements in planar lipid membranes (Nakae 1976; Hancock, Decad and Nikaido 1979). Porins fold in the outer membrane as β -barrels made of antiparallel β -sheets with hydrophobic amino acids facing outward and hydrophilic residues inside the barrel and lining the constricted pore (Fernandez and Hancock 2012). This definition is still nowadays used in case of members of the *Pseudomonas* genus. However, in the case of *Enterobacteriaceae*, the term 'porin' was exclusively affected to large non-specific outer membrane β -barrel channels such as OmpF or OmpC (Nikaido 2003). Thus, two classes of outer membrane diffusion channels can be distinguished in Gram-negative bacteria: non-specific large general porins and substrate-specific channels (van den Berg 2012). Since *Pseudomonas* members do not display such large general porins, applying strictly this definition would result in the absence of porins. However, since numerous studies focusing on *Pseudomonas* members still use the term porin for outer membrane channels, it will be used throughout this review. We will therefore stick to the definition by Henderson et al. (2016) who proposes that 'the outer membrane β -barrel proteins termed porins allow the passage of solutes or contribute to the envelope stability'. *Pseudomonas aeruginosa* is characterized by the very low permeability of its outer membrane, representing about 8% of that of *Escherichia coli*, which at least partly contributes to the high intrinsic and induced resistance to antibiotics (Hancock 1998). One of the reasons for this low permeability is the already mentioned absence of large general diffusion porins, such as OmpF and OmpC (Pratt et al. 1996). Another reason is that the OprD (Occ) family comprises 19 members (Hancock and Brinkman 2002; Tamber, Ochs and Hancock 2006; Liu et al. 2012a,b), which together are involved in the specific uptake of a wide range of small molecules of typically 200 Da or less (Eren et al. 2012). Crystal structures for 14 members of this family have been obtained, all of which show channels that are substantially narrower than those of the enterobacteria porins (Eren et al. 2012).

There are different families of porins, including the so-called structural porins of the OmpA family (Smith et al. 2007; Confer and Ayalew 2013), the small porins of the OmpW family (8 β -sheets) (Hong et al. 2006; Benz et al. 2015; Catel-Ferreira et al. 2016) and larger diffusion porins with 18 β -sheets (Hancock and Brinkman 2002). Still, larger channels with 22 antiparallel β -sheets are present in the outer membrane, the TonB-dependent receptors for the uptake of siderophores, heme and organic sulfur molecules. They are energized by the TonB inner membrane protein which relays the proton motive force opening the gate to permit the passage of large molecules (Cornelis and Bodilis 2009). Other specialized channels are involved in the efflux of toxic molecules, including antibiotics, or participate in secretion systems, but are not going to be discussed in this review (Hancock and Brinkman 2002; Schweizer 2003). This review will therefore focus on the 26 porins of *P. aeruginosa*, including OprF, which is the major non-lipoprotein outer membrane protein, and the homolog of OmpA of *E. coli*. Given the many data that recently emerged on OprF, and in terms of its numerous important functions as well as the complex regulation of its expression, this review will put a particular emphasis on this amazing protein. The other porins described here are the two small OprG and OprH proteins, the two OprB glucose porins, the OprO and OprP phosphate porins

and the members of the so-called OprD (Occ) family (Hancock and Brinkman 2002; Tamber, Ochs and Hancock 2006; Liu et al. 2012a,b). The 19 members of the OprD family which have been renamed Occ (outer membrane carboxylate channel) are phylogenetically split into two subfamilies, OccD being involved in the uptake of basic amino acids and the OccK for the uptake of negatively charged cyclic molecules (Tamber, Ochs and Hancock 2006; Eren et al. 2012, 2013). However, despite the new nomenclature that takes into account the functions of these channels, most articles still use the old Opr- Opd- names. To help understanding, the double nomenclature will be used throughout this review.

GENOMIC CONTEXT AND EXPRESSION REGULATION

Most porin genes (16 out of 26) are transcribed as monocistronic mRNAs, which does not mean that they are not co-transcribed or co-regulated with other genes in the vicinity (Table 1). However, some outer membrane porin genes are clearly in an operonic structure as shown in Table 1 and in Fig. 1. Many regulators are involved in the control of porin genes expression, including (i) two-component systems where a sensor in the inner membrane detects a signal which is relayed by phosphorylation to a response regulator (Rodrigue et al. 2000; Zschiedrich, Keidel and Szurmant 2016); (ii) extracytoplasmic function (ECF) sigma factors, which are transcription factors that are involved in stress responses perceived outside the cytoplasm, and/or in the regulation of numerous genes encoding proteins having ECFs (Potvin, Sanschagrin and Levesque 2008; Llamas et al. 2014; Schulz et al. 2015). The involvement of the different types of regulators in the expression of porin genes will be developed further in this review.

STRUCTURAL CHARACTERISTICS OF PSEUDOMONAS AERUGINOSA OUTER MEMBRANE PORINS

Most porins from *P. aeruginosa* have a molecular mass ranging from 45.4 kDa (OpdG/OccK9) to 53 kDa (OpdP/OccD3), except the two smaller OprG (25.2kDa) and OprH (21.6 kDa) and the OprF porin (37.6 kDa) (Table 1). The structure of 16 porins has been determined (Fig. S1, Supporting Information; Table 1), including the small β -barrel porin OprG with only 8 β -sheets (Kucharska et al. 2015, 2016), while the porins belonging to the OprD/Occ family all have 18 β -sheets. The structure of the OprF porin is still a matter of debate, since full-length OprF resists crystallographic efforts and the link between its functions and tertiary or quaternary structures remains controversial and will be discussed further. The OprD/Occ family comprise 19 members divided into two subfamilies: the OccD (8 members) and the OccK (11 members) (Tamber, Ochs and Hancock 2006; Eren et al. 2012). The structures of OccD1-3 and OccK1-OccK6 have been determined (Fig. S1) (Eren et al. 2012, 2013). The porins of the OccD family have a smaller pore compared to those of the OccK subfamily, but all have a basic ladder (row of Arg and Lys residues) in the barrel wall, the side chains pointing to the lumen (Eren et al. 2012, 2013). The OccD porins have a more dynamic channel which can be closed or open while the OccK porins have a more rigid channel (Eren et al. 2012, 2013).

Table 1. List of porin genes and alternative porin name designation, PAO1 gene number, molecular mass, direction (Dir.) of transcription (>forward strand, <reverse strand), operonic structure, possible function, antibiotic (ATB) transport, regulators controlling the porin expression, number of orthologs, orthologs group and associated transporter genes (<http://pseudomonas.com>; Winsor et al. 2016).

Gene	PAO1 n°	PA14 n°	Mass (kDa)	Dir.	Operon	Function	ATB transport	Regulators	Sigma factors ^a	Orthologs	Ortholog group (*)	Transporter-associated
<i>oprF</i>	PA1177	PA14_41570	37.6	>	No ^b	Structural ^c		AmpR	AlgU ^{1,3} , SigX ^{*1} , RpoS ¹	48	POG003618 (572)	
<i>oprB</i>	PA3186	PA14_23030	50.8	<	PA3190-3186	Glucose uptake		Anr, GltR	RpoS ^{2,3}	38	POG002430 (735)	PA3189-3187 (ABC)
<i>oprB2</i>	PA2291	PA14_34960	50.5	>	No	Glucose uptake		?	(SigX)	37	POG002430 (735)	
<i>oprG</i>	PA4067	PA14_11270	25.2	>	No	Fe ²⁺ uptake?		Anr	SigX ^{1,2,3} , FecI ²	48	POG001618 (570)	
<i>oprH</i>	PA1178	PA14_49200	21.6	>	<i>oprH-phoP-phoQ</i>	OM stabilization		PhoP-PhoQ, BrlR, BqsR/CarR	RpoS ^{1,2} , FecI ¹	41	POG001136 (469)	
<i>oprP</i>	PA3279	PA14_21620	48.2	<	No	Phosphate		PhoB, TctD	RpoH ^{1,2} , RpoS ¹ , (SigX)	28	POG002334 (719)	
<i>oprO</i>	PA3280	PA14_21610	47.8	<	No	Pyrophosphate		PhoB, TctD	RpoH ¹ , RpoS ¹ , (SigX)	25	POG002334 (719)	
<i>oprD (occD1)</i>	PA0958	PA14_51880	48.4	<	No	Arginine	Imipenem/meropenem	ArgR, Czcr	RpoN ^{1,3} , SigX ^{1,3} , FliA ¹	37	POG000187 (1656)	
<i>opdC (occD2)</i>	PA0162	PA14_02020	48.9	>	No	Histidine, arginine			SigX ^{1,2,3} , FliA ¹	29	POG000160 (459)	
<i>opdP (occD3)</i>	PA4503	PA14_58410	53	>	PA4501-4506	Gly-Glu, arginine			RpoN ^{2,3}	38	POG004088 (516)	ABC transporter
<i>opdI (occD4)</i>	PA2505	PA14_32270	49.8	>	No	Tyrosine		?	(FecI)	49	POG000187 (1656)	
<i>opdI (occD5)</i>	PA0189	PA14_02370	48.9	<	No	Arginine		?	?	14	POG000187 (1656)	
<i>oprQ (occD6)</i>	PA2760	PA14_28400	46.9	>	No	Arginine		MexT	RpoS ¹ , SigX ¹	48	POG002810 (552)	
<i>opdB (occD7)</i>	PA2700	PA14_29220	47.3	>	PA2699-2701	Proline, arginine		?	?	23	POG000187 (1656)	MFS
<i>opdJ (occD8)</i>	PA2420	PA14_33410	51.3	>	PA2418-2421	Arginine		?	?	14	POG003114 (312)	PA2419 is an hydrolase
<i>opdK (occK1)</i>	PA4898	PA14_64720	45.8	<	No	Vanillate, benzoate	Carbenicillin, cefoxitin, tetracycline,	?	?	26	POG000239 (1215)	
<i>opdF (occK2)</i>	PA0240	PA14_02980	46.1	<	PA0241	Glucuronate	Carbenicillin, cefoxitin, gentamycin, temocillin	?	(FecI)	68	POG000239 (1215)	MFS
<i>opdO (occK3)</i>	PA2113	PA14_37260	44.3	<	PA2114-2110	Pyroglutamate		?	?	14	POG003356 (336)	PA2114 is an MFS
<i>opdL (occK4)</i>	PA4137	PA14_10440	46.04	>	No	Phenylacetate		?	?	26	POG001562 (382)	
<i>opdH (occK5)</i>	PA0755	PA14_54520	47	<	PA0755-0751	Cis-aconitate, tri-carboxylates		TctD	?	39	POG000729 (882)	(tctABC)Tri-carboxylate transport
<i>opdQ (occK6)</i>	PA3038	PA14_24790	46.7	>	No			NarXL	?	28	POG002549 (380)	Acyl-CoA dehydrogenase,
<i>opdD (occK7)</i>	PA1025	PA14_51070	46.5	>	PA1020-1025		Meropenem	?	?	24	POG000987 (301)	PA1024 nitropropane dioxygenase
<i>oprE (occK8)</i>	PA0291	PA14_03800	49.7	>	No			IHF, OxyR	SigX ¹ , RpoN ^{1,2} , FecI ^{2,1}	53	POG000288 (540)	
<i>opdG (occK9)</i>	PA2213	PA14_36090	45.4	>	No			PA2206	?	23	POG000239 (1215)	
<i>opdN (occK10)</i>	PA4179	PA14_09850	47.8	>	No			?	?	26	POG000729 (882)	
<i>opdR (occK11)</i>	PA3588	PA14_17890	45.7	<	PA3593-3588			?	?	13	POG002082 (306)	Acyl-coA metabolism

^aAccording to ChIP data (Schulz et al. 2015). Under brackets are shown sigma factors that have not been considered statistically significant but interactions were positive in the two repetitions.

^bThe genomic context of *oprF* is detailed in the text and in Fig. 2.

^cThe multiple functions of *OpdF* are detailed in the text.

^dInvolvement of SigX in *oprF* transcription is discussed in the text.

(*) Number of members.

¹ChIP, ²Motif, ³RNA seq (according to Schulz et al. 2015).

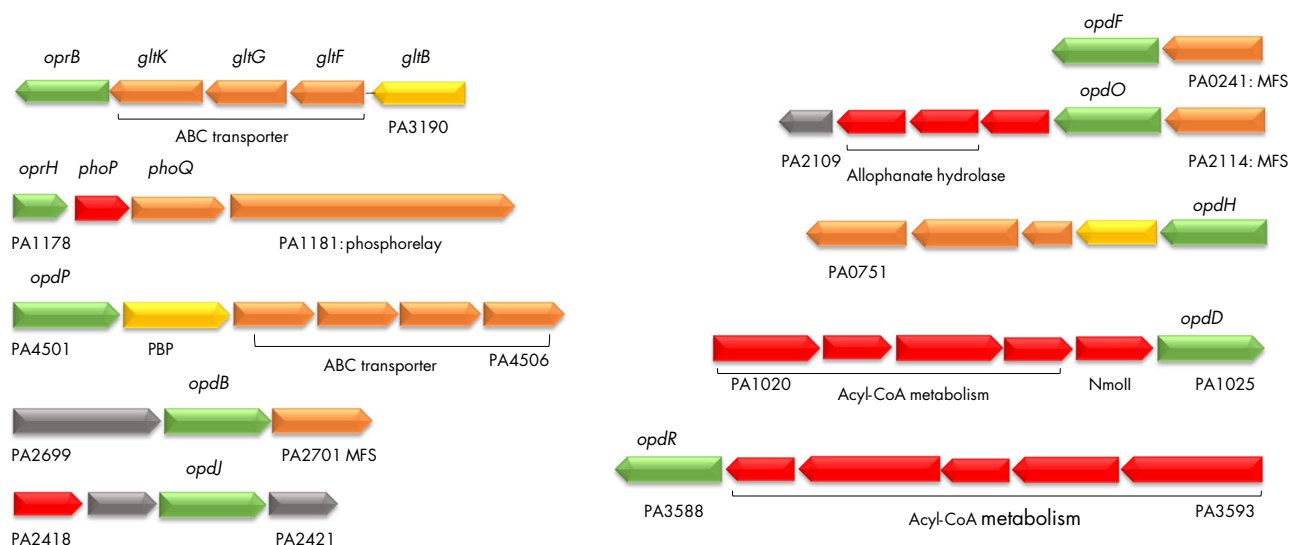

Figure 1. Porin genes contained in operons. Operons including porin-encoding genes from *P. aeruginosa* PAO1 (pseudomonas.com). Predicted localization of the encoded proteins is indicated by colors as in Pseudomonas.com (green: outer membrane; orange: cytoplasmic membrane; red: cytoplasmic; yellow: periplasmic; gray: unknown). ABC: ATP-binding cassette; PBP: probable binding protein component of ABC transporter; MFS: major facilitator superfamily transporter; Nmoll: type II nitronate monooxygenase (Salvi et al. 2014).

OprF, THE MAJOR AND MULTIFARIOUS PORIN OF PSEUDOMONAS AERUGINOSA

As the most abundant non-lipoprotein outer membrane protein in *P. aeruginosa*, OprF has been the object of numerous research works since 1979 (Hancock and Carey 1979; Hancock, Decad and Nikaido 1979). The most recent reviews dealing with OprF focused on two specific aspects, folding pathways (Sugawara, Nagano and Nikaido 2012) and involvement in pathogenesis (Krishnan and Prasadarao 2012), but a comprehensive review on this protein is missing. We therefore devoted a large part of the present review on OprF, which is justified by the large amount of available data, the variety of functions in which OprF is involved, and recent new findings, for example in the regulation of the *oprF* gene.

The elusive structure of OprF

OprF of *P. aeruginosa* is homologous to the outer membrane protein A (OmpA) of *Escherichia coli*, and these two proteins are the best studied members of the OmpA protein family. The structures of OmpA and OprF were reviewed and compared in 2012 (Reusch 2012; Sugawara, Nagano and Nikaido 2012). Briefly, OprF (326 residues) folds into three domains: the crystallized N-terminal eight-stranded β -barrel located in the outer membrane (Brinkman, Bains and Hancock 2000; Reusch 2012) (Fig. 2A, Fig. S1), a cysteine-rich linker that may be partly surface exposed (Hancock and Carey 1979; Hancock, Decad and Nikaido 1979; Bodilis et al. 2004) and the C-terminal part containing α -helices and/or β -strands (Sugawara, Nagano and Nikaido 2012). As OmpA, OprF generates two distinct conformers corresponding to a closed channel (the most abundant form) and a rare (<5% of the conformers) open channel (Sugawara and Nikaido 1994). The closed conformer contains the two domains mentioned above (the N-terminal eight-stranded β -barrel and the C-terminal periplasmic globular domain), whereas the open form folds as a single domain protein with a larger number of transmembrane β -strands (14 to 16) (Sugawara et al. 2006; Sugawara, Nagano and Nikaido 2012). The OprF channels mainly

exist in weakly conductive subconformations and switch to the fully open state for a short time only (Nestorovich et al. 2006), thereby contributing to the low permeability of *P. aeruginosa* outer membrane reported earlier (Bellido et al. 1992). Interestingly, the channel conductance can be modulated in function of the bacterial growth temperature, with 80 pS and 250 pS measured when bacteria were grown at 17°C or 37°C, respectively (Jaouen et al. 2004). While the small channel size is consistent with the predicted structure of the crystallized N-terminal domain, the largest one remains controversial, and has been attributed either to a folding of OprF as a large single domain or to the oligomerization of three subunits folding into three small channels of about 80 pS each (Jaouen et al. 2004; Sugawara et al. 2006). Remarkably, the recent discovery of unfolded OmpA monomers and oligomers that mimic amyloid fibers structures sheds new light into OmpA, and possibly also into OprF structures and associated functions (Wang et al. 2013; Danoff and Fleming 2015). It is interesting to mention that the largest OprF conformer proportion in the outer membrane increases in a mutant that does not make the periplasmic chaperone Skp, suggesting that in the absence of this chaperone, OprF could be misfolded like in the case of OmpA (Sugawara, Nagano and Nikaido 2010, 2012).

OprF as a channel

OprF was first considered to function as a non-specific aqueous channel, allowing the passage of ions and low molecular mass sugars (Bellido et al. 1992), but it has also been suggested to allow the passage of toluene since a mutant not expressing *oprF* is more tolerant to toluene (Li et al. 1995). OprF has also been suggested to allow the diffusion of iron-chelated non-cognate siderophores (Meyer 1992). An interesting observation is the increased levels of OprF in *P. aeruginosa* cells grown under anaerobic conditions in the presence of nitrate, suggesting a possible involvement of OprF in the diffusion of nitrates and nitrites (Yoon et al. 2002).

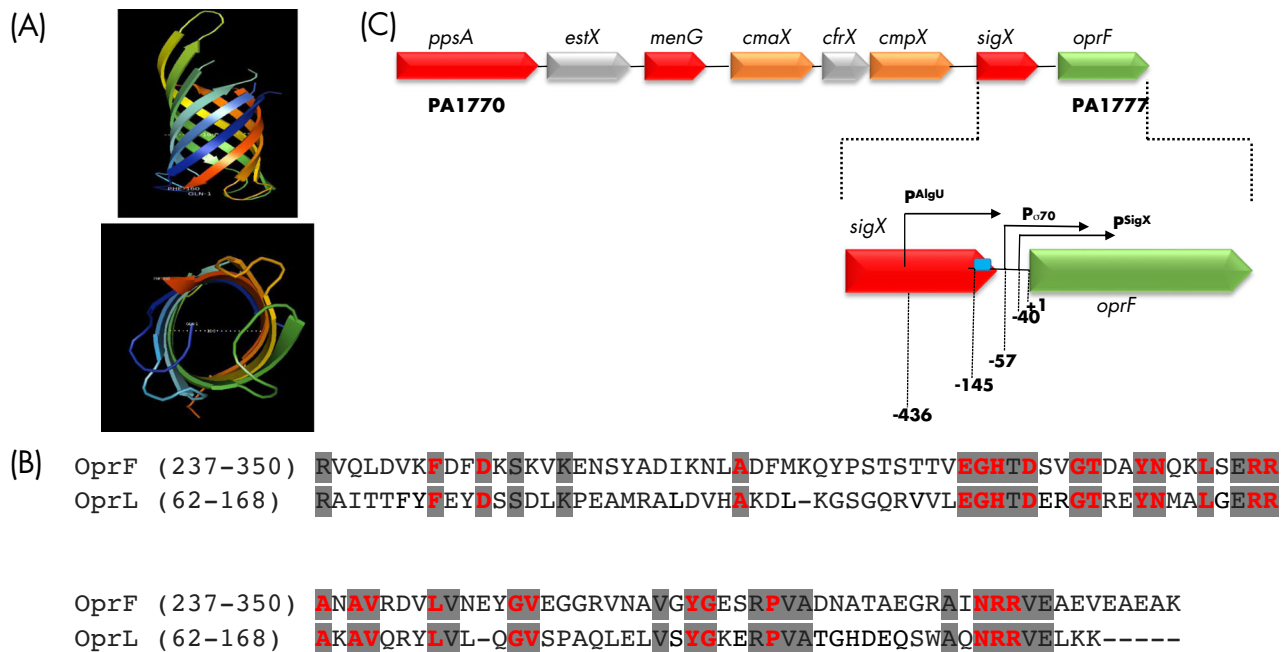

Figure 2. *oprF* genomic context and C-terminal protein similarity with OprL. (A) Schematic representation (PyMOL Molecular Graphics System, Version 1.8 Schrödinger, LLC) viewed from the side (top) and from the extracellular environment (bottom) of the N-terminal part of OprF based on the X-ray crystal structure (PDB 4RLC). (B) Sequence (amino-acids) conservation between OprF and OprL. Conserved residues between the two proteins are shaded in gray. Peptidoglycan-binding residues are indicated in red (Cascales and Llobes 2004). (C) Genomic locus including *oprF* and the seven genes upstream genes and localization of *oprF* promoter regions. The transcriptional initiation sites of the three promoters lying upstream of the *oprF* gene (P^{SigX} , $P^{\sigma 70}$, P^{AlgU}), corresponding to SigX-, $\sigma 70$ - and AlgU-dependent promoters, respectively, are indicated by arrows. Their positions are indicated relative to the translational initiation start of *oprF* (+1). Position of AmpR putative binding site is indicated (blue square).

OprF involvement in maintaining the outer membrane integrity

OprF plays a structural role, contributing to maintenance of the cell shape, especially under low osmolarity conditions, since the C-terminal part contains a peptidoglycan binding domain, which anchors the outer membrane to the peptidoglycan layer (Gotoh et al. 1989; Rawling, Brinkman and Hancock 1998). OprF mutants lacking various portions of the C-terminal part confirmed that the N-terminal 164 amino acids are sufficient for protein production and membrane insertion, while the C-terminal part is needed for stable interaction with peptidoglycan (Rawling, Brinkman and Hancock 1998). The cells expressing C-terminally truncated OprF were both sensitive to low osmolarity and their cell length was reduced (Rawling, Brinkman and Hancock 1998). A comparison with OprL, the peptidoglycan-associated lipoprotein (PAL) (Lim et al. 1997), reveals the presence of remarkably conserved residues in the C-terminal part of both proteins (Fig. 2B). These residues are also conserved in the different PAL homologs in Gram-negative bacteria and are involved in the association with peptidoglycan or with TolA, an inner membrane protein which, together with TolC, TolQ and TolR, forms the Tol-PAL complex that insures the outer membrane integrity (Journet et al. 1999; Cascales et al. 2002; Cascales and Llobes 2004). In *E. coli*, the PAL lipoprotein can also dimerize and interact with OmpA (Cascales et al. 2002). Since OprF belongs to the OmpA family, and because the critical residues for the interactions with peptidoglycan and Tol proteins are present in its C-terminal part, it is reasonable to suggest that OprF could either dimerize or interact with OprL, TolA, TolB and peptidoglycan, in line

with the published evidence of its role in maintaining cell integrity under some environmental stresses (Rawling, Brinkman and Hancock 1998). In a study aiming at probing the protein interaction network of *P. aeruginosa* PAO1 by *in vivo* covalently linking interacting protein partners, OprF was confirmed to form homodimers and to interact with OprL (Navare et al. 2015). OprF and OprL were found to interact via their C-terminal part containing the conserved residues mentioned above. The small and abundant OprI lipoprotein (Cornelis et al. 1989) was also shown to interact with both OprF and OprL, suggesting the existence of ternary OprF-OprL-OprI complexes involved in cell shape and outer membrane stability. Four other OprF partners were identified: the translation initiation factor IF-2 encoded by the *infB* gene and the PA1041, PA1522 and PA1964 proteins of unknown functions. Of these four proteins, only PA1041 is predicted to be an OmpA-like outer membrane lipoprotein (Remans et al. 2010; Navare et al. 2015; Winsor et al. 2016), but the relevance of these interactions remains unknown. Finally, it is worth mentioning that these conserved PAL motifs are not present in the other *P. aeruginosa* porins (results not shown).

OprF and biofilm formation

Pseudomonas aeruginosa forms thick biofilms (defined as microbial communities of sessile cells embedded into a matrix of extracellular polymeric substances that they have produced) under anaerobic conditions in the presence of nitrate, which is accompanied by higher levels of OprF in the outer membrane (Hassett et al. 2002; Yoon et al. 2002). Furthermore, an *oprF*-negative mutant forms very poor biofilms under these anaerobic conditions and the cells lack nitrite reductase activity,

making an interesting link with the previous suggestion that OprF could be involved in the diffusion of nitrates/nitrites (Hassett et al. 2002; Yoon et al. 2002). In line with these results, it was demonstrated that hypoxic conditions, such as those encountered in the CF lung, favor a higher expression of *oprF* (Hogardt and Heesemann 2010; Eichner et al. 2014). In artificial sputum medium (ASM), mimicking the conditions in the CF lung, Sriramulu et al. (2005) found that OprF is needed for the formation of microcolonies and that the high levels of amino acids present in this medium favor high OprF production levels, whereas low OprF levels were observed in ASM without added amino acids. However, in LB medium under microaerobic conditions, but in the absence of additional nitrate, Bouffartigues et al. (2015) showed that an *oprF*-negative mutant forms aggregates in liquid medium accompanied by higher levels of extracellular Pel polysaccharides, and more strongly attached biofilm, in stark contrast to the anaerobic growth conditions mentioned above. These phenotypes could partly be the result of increased levels of cyclic-di-GMP intracellular levels, which are known to favor biofilm formation (Bouffartigues et al. 2015). These contrasting results could be explained by the different conditions used (anaerobic vs aerobic), different media (LB vs ASM) and the presence or absence of nitrate.

OprF function in binding and adhesion to mammalian cells

Adhesion of *P. aeruginosa* to human lung alveolar epithelial cells has been found to be, at least partly, mediated by OprF since an *oprF*-negative mutant had its binding capacity reduced by about 60% while pre-incubation of epithelial cells with purified OprF or with a monoclonal antibody against OprF also reduced attachment (Azghani et al. 2002). Likewise, OprF has been found to be involved in the binding to human middle ear epithelial cells, probably facilitating the invasion of *P. aeruginosa* in otitis media (Mittal et al. 2014). In chronic suppurative otitis media caused by *P. aeruginosa*, actin rearrangement occurs due to phosphorylation of protein kinase C (PKC) and OprF was found to be necessary for PKC activation (Mittal et al. 2016). In a separate study, an *oprF* mutant of PAO1 showed a drastic reduction of adherence to rat glial cells and to Caco2/TC7 cells while wild-type adhesion level was restored upon complementation with the *oprF* gene in trans (Fito-Boncompte et al. 2011). OprF has also been found to interact with the lectin LecB, which is exposed at the surface of *P. aeruginosa* cells and both proteins contribute to the hemagglutination of erythrocytes (Funken et al. 2012).

OprF involvement in outer membrane vesicle biogenesis and functions

Outer membrane vesicles (OMVs) are nanostructures (20–300 nm in diameter) produced by almost all Gram-negative bacteria. They are spherical vesicles delimited by a bilayer membrane originating from the bacterial outer membrane. OMV membrane is therefore made of an outer lipopolysaccharide (LPS) leaflet, an inner phospholipid leaflet and outer membrane proteins. OMVs were also shown to contain bacterial periplasmic components (proteins and cell wall components), proteins of the bacterial inner membrane, cytoplasmic proteins, DNA and RNA, ions, metabolites and signaling molecules (Kulp and Kuehn 2010; Kim et al. 2015; Pathirana and Kaparakis-Liaskos 2016). They are produced by planktonic bacteria, but also by bacteria in biofilms and can thus be considered as components of biofilm matrixes (Schooling and Beveridge 2006).

Several general models of events leading to outer membrane budding and OMV biogenesis were proposed, including the loss of links between the outer membrane and the peptidoglycan layer in regions where vesiculation will take place (Kulp and Kuehn 2010). Since OprF and the lipoproteins OprL and OprI tether the outer membrane to peptidoglycan, their roles in *P. aeruginosa* PA14 OMV biogenesis were investigated and the absence of OprF led to OMV amounts increased by about 8-fold (Wessel et al. 2013). The PQS quorum-sensing signaling molecule is hydrophobic and associates with LPS in the external leaflet of the outer membrane, causing the outer leaflet to expand relative to the inner leaflet, yielding OMV budding from the bacterial surface (Schertzer and Whiteley 2012). In the *oprF* mutant of PA14, the higher OMV biogenesis level was shown to result from an increase in PQS production rather than from a decrease in outer membrane–peptidoglycan linkage (Wessel et al. 2013). An *oprI* mutant produced a 3-fold higher OMV level than the wild-type strain, while its PQS production was unaffected, indicating that the absence of OprI stimulated OMV biogenesis by reducing the outer membrane tethering to peptidoglycan. Finally, the OMV amount was unaffected in an *oprL* mutant compared to the wild-type strain (Wessel et al. 2013). The different mechanisms by which OprF and OprI impact OMV formation and the lack of effect of OprL indicate that, although these three proteins likely form ternary complexes maintaining the outer membrane integrity (Navare et al. 2015), they can also act individually. To the best of our knowledge, it remains unknown if variations in OprF levels in wild-type cells are sufficient to modulate OMV formation.

Several proteome studies identified OprF as a constituent of OMVs produced by *P. aeruginosa* PAO1 in various conditions: liquid cultures, biofilms, antibiotic treatment (Choi et al. 2011; Maredia et al. 2012; Toyofuku et al. 2012; Couto et al. 2015; Park et al. 2015). OprF was found to be the second most abundant protein in OMVs from liquid cultures (Choi et al. 2011) and was among the 30 most abundant proteins in OMVs from biofilms (Couto et al. 2015). Park et al. (2015) observed that some outer membrane proteins can be preferentially incorporated or omitted into OMVs, supporting the notion of a specific protein packaging during OMV biogenesis. OprF was over-represented in biofilm and planktonic OMVs at the 24-h time point (Park et al. 2015), suggesting that OprF could play important roles in OMV biogenesis. OMVs allow the transport of biological material from the parental bacterium to distal sites. In various Gram-negative bacteria, they were shown or proposed to display a variety of functions including transfer of antibiotic resistance, competition with other bacteria, stress response and bacterial survival, virulence factor delivery, bacterial adhesion and biofilm formation, nutrient and iron acquisition, cell communication, host cell invasion and modulation, and immune evasion (Kulp and Kuehn 2010; Kim et al. 2015; Orench-Rivera and Kuehn 2016; Pathirana and Kaparakis-Liaskos 2016). OprF could contribute to one or several of these functions, for example, given its involvement in the binding of *P. aeruginosa* to human cells (see above paragraph), it is tempting to hypothesize that OprF contributes to the interaction of OMVs with host cells. To our knowledge, the contribution of OprF or other individual proteins in OMV functions has not been reported yet.

OprF involvement in quorum-sensing response

Quorum sensing (QS) is a cell density-dependent mechanism characterized by the production of diffusible extracellular signal molecules, which trigger cellular responses, such as the

production of virulence factors in the case of *P. aeruginosa* (Venturi 2006; Williams and Camara 2009; Papenfort and Bassler 2016). *Pseudomonas aeruginosa* produces two types of N-acyl-homoserine lactones, N-(3-oxododecanoyl)-L-homoserine lactone (3-oxo-C12-HSL), and N-butyl-L-homoserine lactone (C4-HSL) (Venturi 2006) and two 4-hydroxy-2-alkylquinolines (HAQs), which includes 3,4-dihydroxy-2-heptylquinoline, also known as the *Pseudomonas* quinolone signal (PQS), and its precursor, 4-hydroxy-2-heptylquinoline (HHQ) (Diggle et al. 2007; Dubern and Diggle 2008). Another molecule, termed IQS, has been proposed as well as the product of the *ambBCDE* locus (Lee et al. 2013). However, more recent data show that IQS is in fact aeruginaldehyde, a by-product of the pyochelin siderophore biosynthetic pathway rather than the product of the *ambABCDE* locus as proposed by Lee et al. (Ye et al. 2014; Rojas Murcia et al. 2015). In the *las* system, the synthase LasI produces 3-oxo-C12 HSL and the LasR regulator binds the signal molecule, activating several target genes, while the *rhl* system involves RhlI, the C4-HSL synthase and the RhlR response regulator. These two systems are inter-connected and activate together the production of numerous virulence factors including elastase, staphylolytic protease, exotoxin A, rhamnolipids, pyocyanin, lectins and superoxide dismutases (Venturi 2006; Williams and Camara 2009). On the other hand, the HHQ and PQS signal molecules interact with the PqsR/MvfR regulator and together trigger the production of virulence factors, including the LecB lectin and the phenazine compound pyocyanin (Diggle et al. 2007). Recently, it was found that MvfR is a truly global regulator of QS system in *P. aeruginosa*, regulating both *rhl* and *las* systems as well as genes for the defense against oxidative stress, highlighting the central role of the HHQ-PQS/MvfR system in *P. aeruginosa* (Maura et al. 2016).

The production of several QS-controlled virulence factors (pyocyanin, elastase, LecA lectin, exotoxin A) is strongly reduced in an *oprF* mutant (Fito-Boncompete et al. 2011). Accordingly, the production of PQS by the *oprF* mutant was found to be decreased while the production of HHQ was considerably increased (Fito-Boncompete et al. 2011). The conversion of HHQ to PQS involves a hydroxylation reaction realized by the PqsH enzyme, the gene of which is under the control of the LasR (Diggle et al. 2007). In line with the accumulation of HHQ, and the decreased production of 3-oxo-C12-HSL in the *oprF* mutant, the activity of a *pqsH-lacZ* fusion was decreased in the *oprF* mutant (Fito-Boncompete et al. 2011). An impact of OprF on PQS production was also reported by Wessel et al. (2013), but it was opposite: the PQS level was increased in an *oprF* mutant. This discrepancy could result from the use of different parental strains (the PAO1-derivative H103 by Fito-Boncompete et al. and PA14 by Wessel et al.), different culture conditions and/or different PQS quantification methods (LC/MS by Fito-Boncompete et al. and TLC by Wessel et al.). In a *P. aeruginosa* PAO1 *pqsA* mutant unable to produce HHQ and PQS, the transcription of *oprF* and *sigX*, the sigma factor gene upstream of *oprF* (see below) was 4-fold higher than in a wild-type background, suggesting an involvement of these QS regulators on transcriptional control of *sigX* (Gicquel et al. 2013).

OprF involvement in the perception of environmental cues

Several reports strongly support a role of OprF as an outer membrane protein involved in the perception of environmental signals, including some produced by the infected host. The innate

immune system complement cascade is a first line of defense against pathogens and it involves the conversion of C3 to C3a and C3b, which typically recognizes a component at the surface of the pathogen, activating the C5 convertase and the formation of C5b-9 membrane attack complex (Joiner, Fries and Frank 1987). OprF is probably a *P. aeruginosa* C3b receptor since an *oprF*-negative mutant showed reduced C3b binding compared to the wild type while expression of *oprF* in *E. coli* increased the deposition of C3b (Mishra et al. 2015). Wu et al. (2005) also demonstrated that among all tested cytokines, OprF binds interferon-gamma (IFN- γ), inducing expression by *P. aeruginosa* of the LecA lectin, a virulence factor under the control of the Rhl QS system. In line with the increased *lecA* expression, the same authors found that IFN- γ also induces the *rhlI* gene encoding the C4-HSL synthase (Wu et al. 2005).

During an acute phase of inflammation, the serum amyloid protein (SAA) is produced by hepatocytes and it was found that it tightly binds to Gram-negative bacteria, including *E. coli*, *Salmonella enterica* Thyphimurium, *Shigella flexneri*, *Klebsiella pneumoniae*, *Vibrio cholerae* and *P. aeruginosa* (Hari-Dass et al. 2005). In *E. coli*, OmpA is bound by SAA, while OprF is likely to be the target in *P. aeruginosa* since an *oprF* mutant is unable to bind SAA (Hari-Dass et al. 2005).

OprF importance in acute and chronic infections

In one study, mice were infected with *P. aeruginosa* PAO1, either to cause sepsis (acute infection) or chronic wound infection, and total gene expression was compared with cells grown in mid-logarithmic phase in a MOPS-succinate medium under laboratory conditions (Turner et al. 2014). Under both infection conditions, *oprF* expression was found to be downregulated, especially in the case of chronic wound infection where the expression was decreased by a factor 7.7 (Turner et al. 2014). This result seems to be counterintuitive given the importance of OprF for the expression of virulence factors (Fito-Boncompete et al. 2011), but one should take other factors into account than the degree of expression in order to evaluate the contribution of a given gene in fitness during infection processes (Turner et al. 2014). One way to address this issue is the use of massive random transposon insertions in a Tn-seq approach by comparing the number of independent transposon insertions in one given gene when bacteria are grown in laboratory conditions or *in vivo* in acute or chronic infections. In their study, Turner et al. (2014) found that the number of insertions in the *oprF* gene was quasi null in the case of bacteria recovered from acute infections and zero in the case of bacteria from chronic wound infection, indicative of a high fitness cost caused by *oprF* inactivation, supporting the importance of OprF in the infection process. Another type of infection caused by *P. aeruginosa* is the CF lung chronic colonization (Folkesson et al. 2012). In a recent study, it was revealed that transposon insertions in the *oprF* gene were almost absent when *P. aeruginosa* PAO1 was grown in CF sputum medium indicating an important fitness cost as well, while in the case of PA14, no insertion was found suggesting that *oprF* is an essential gene in this strain, at least in this growth condition (Turner et al. 2015). Interestingly, the same study showed that *sigX* is essential in both strains for growth in sputum medium (Turner et al. 2015). In non-CF bronchiectasis, an important T-cell response to OprF protein and an immune-dominant HLA-restricted T-cell epitope of OprF was detected (Quigley et al. 2015).

Genomic environment and regulation of *oprF* transcription

A first transcriptional study suggested that *oprF* was constitutively transcribed as a single gene from a σ^{70} -type promoter (Duchene et al. 1988). However, subsequent work showed that although the *oprF* predominant mRNA is monocistronic, a larger *sigX-oprF* transcript could be detected (Brinkman et al. 1999). RT-PCR experiments furthermore indicated transcriptional linkages between the *estX*, *menG*, *cmaX*, *cfrX*, *cmpX* and *sigX* genes (PA1771 to PA1776 in *P. aeruginosa* PAO1) lying upstream of *oprF* (PA1777) (Fig. 2C), which suggested that *oprF* was the last of a seven-gene operon (Brinkman et al. 1999), which remains to be confirmed. Remarkably, this genomic structure, including *ppsA* upstream of *estX*, is fully conserved, not only among all of the sequenced *P. aeruginosa* genomes, but also among all of the sequenced genomes of members of the *Pseudomonas* genus (572 genomes; Winsor et al. 2016) (Table 1), suggesting both genetic and functional links between all of the genes and the corresponding proteins. The genes in this cluster are predicted to encode mainly proteins with putative functions: this is the case for the EstX esterase, the MenG ribonuclease E inhibitor, the CorA-like inner membrane Mg²⁺ transporter protein CmaX, the CfrX hypothetical protein of unknown function and the CmpX putative small mechanosensitive channel of the MscS family (Winsor et al. 2016). By contrast, SigX is an ECF sigma factor sharing 49% of similarity with SigW from *Bacillus subtilis*, which is known to regulate the membrane fluidity by changing the branched-to-linear fatty acid ratio (Kingston et al. 2011). SigX has recently been characterized and was found to be a master regulator since the deletion of its gene affects the expression of more than 300 genes, leading to changes in the production of virulence traits and resulting in increased formation of biofilms (Gicquel et al. 2013; Blanka et al. 2014; Bouffartigues et al. 2015; Schulz et al. 2015). SigX is involved in *de novo* fatty acids biosynthesis, thus regulating membrane fluidity (Boechat et al. 2013; Blanka et al. 2014) and outer membrane biogenesis (Duchesne et al. 2013). Since SigX is activated in response to factors causing cell wall stresses (low osmolarity, high sucrose concentration, absence of OprF, D-cycloserine treatment), this ECF sigma factor has been proposed to represent a new envelope stress response regulator (Bouffartigues et al. 2012; Duchesne et al. 2013, 2014, 2015; Blanka et al. 2014). Remarkably, SigX was shown to be involved in *oprF* transcription in *P. aeruginosa* H103 (a derivative of the PAO1 strain): two intertwined promoters have been identified upstream of *oprF*, one of them being SigX-dependent while the other one depends on the σ^{70} primary sigma factor (Fig. 2C) (Duchene et al. 1988; Brinkman et al. 1999; Bouffartigues et al. 2012). In addition, the *cmpX* promoter region was immunoprecipitated by SigX using a ChIP-seq approach, suggesting a direct influence of SigX also on *cmpX* expression (Blanka et al. 2014). Taken together, these data support the hypothesis of functional relations between the members of this highly conserved genomic structure among *P. aeruginosa* genomes, which have now to be further deciphered.

While SigX is involved in *oprF* transcription in *P. aeruginosa* H103 (Brinkman et al. 1999; Bouffartigues et al. 2012; Gicquel et al. 2013), this has not been clearly established for strain PA14 where *oprF* transcription was not significantly affected by a *sigX* mutation although the *oprF* promoter region was successfully immunoprecipitated by SigX using a ChIP-seq approach (Blanka et al. 2014). In strain PA14, overexpression of *sigX* led to a biphasic growth curve where cells reached a first plateau, followed by a decline phase resulting in swelling and death of the cells be-

fore a recovering phase leading to a new plateau (Boechat et al. 2013). During the first growth phase, the production of OprF was unchanged, but a moderate overproduction was observed when cells recovered (Boechat et al. 2013). In addition, a search for promoters of the ECF sigma factor AlgU led to the identification of a third *oprF* promoter lying within the *sigX* open reading frame (Firoved, Boucher and Deretic 2002) (Fig. 2C). AlgU, a homolog of the *E. coli* ECF σ^E , was especially investigated because its hyperactivity (in most of the cases resulting from a mutation in the *mucA* gene encoding the anti-sigma) leads to overproduction of the exopolysaccharide alginate inducing the mucoid phenotype (Boucher et al. 1997). Firoved et al. showed by primer extension analysis that this AlgU promoter region was active in a strain lacking MucA, which specifically inhibits AlgU (Schurr et al. 1996), resulting in a 2.5-fold increase in *oprF* transcription. The possibility that *oprF* is part of the AlgU regulon suggests that *oprF* is also highly transcribed during lung colonization in CF patients where *mucA* mutants frequently arise. Accordingly, OprF is considered as a marker of *P. aeruginosa* in infected CF patients (Hassett et al. 2002; Eichner et al. 2014). The existence of this AlgU-dependent promoter region has however been the object of controversies since in another study the activities of transcriptional *oprF-lacZ* fusions were not significantly increased in a *mucA* mutant background (Malhotra et al. 2000). It was further shown that this AlgU promoter region only made a 10% marginal contribution to *oprF* expression when bacteria were grown in LB medium (Bouffartigues et al. 2012). Moreover, the global transcription of *oprF* remained quite similar in *mucA* and *algU* mutant backgrounds, in which AlgU was strongly active or absent, respectively (Bouffartigues et al. 2012). Taken together, these results suggest that net *oprF* transcription might remain similar in mucoid (hyperactive AlgU leading to overproduction of the alginate exopolysaccharide) and in non-mucoid strains (weakly or not active AlgU) where SigX-dependent expression is higher (Bouffartigues et al. 2012). Noticeably, the localization of this AlgU-dependent promoter within the *sigX* ORF may suggest that *oprF* transcription initiation from the AlgU-dependent promoter may result in reduced *sigX* expression.

More recently, a binding site for the AmpR regulator belonging LysR family was identified in the close vicinity of the SigX-dependent promoter region using ChIP-Seq assays (Balasubramanian et al. 2014). AmpR is a global transcriptional regulator: it regulates resistance to different classes of clinically relevant antibiotics, either positively by increasing resistance to β -lactams and aminoglycosides or negatively by decreasing resistance to quinolones. AmpR plays a key role in determining *P. aeruginosa* virulence and physiology by regulating expression of transcriptional and posttranscriptional regulators that feed into critical global networks, such as QS, Gac-Rsm and iron uptake (Balasubramanian, Kumari and Mathee 2015). Remarkably, AmpR is an integral part of the stress response system in *P. aeruginosa*, and plays a central role in the cell wall recycling (Balasubramanian et al. 2012). Overall, the discoveries of a complex promoter organization (Brinkman et al. 1999; Firoved, Boucher and Deretic 2002; Balasubramanian et al. 2012; Bouffartigues et al. 2012; Balasubramanian, Kumari and Mathee 2015) revealed that *oprF* transcription is highly regulated and under control of the ECF sigma factors SigX and AlgU, and of the master regulator AmpR, the activity of which has been related to cell wall stress responses (Wood, Leech and Ohman 2006; Balasubramanian et al. 2012; Balasubramanian, Kumari and Mathee 2015).

Transcriptome and proteome studies revealed that *oprF* is always transcribed, explaining why it was originally thought to be constitutively expressed, although its level of expression is

Table 2. Conditions leading to *oprF* expression variations.

Conditions	Strain	Fold change	References
Transcriptomics			
<i>sigX</i> mutant	PAO1	-4	Gicquel et al. (2013)
<i>oprD</i> mutant	PA14	>10	Skurnik et al. (2013)
Chronic/MOPS	PAO1	-7.6	Turner et al. (2014)
Biofilm/planktonic	PA14	-6.3	Tata et al. (2016)
Anaerobic/aerobic	PA14	-5.6	Babin et al. (2016)
TP359 cationic peptide	ATCC 39324 mucoid	-10	Dosunmu et al. (2016)
TP359 cationic peptide	ATCC 39324 non-mucoid	-5	Dosunmu et al. (2016)
Proteomics			
Biofilm LB-nitrate + O ₂ /biofilm LB + O ₂	PAO1	4.9	Yoon et al. (2002)
Biofilm LB-nitrate + O ₂ /biofilm LB - O ₂	PAO1	39	Yoon et al. (2002)
TP359 cationic peptide	ATCC 39324 mucoid	-5	Dosunmu et al. (2016)
TP359 cationic peptide	ATCC 39324 non-mucoid	-3	Dosunmu et al. (2016)
ASM + amino acids	PAO1	>10	Sriramulu et al. (2005)
<i>sigX</i> mutant	PAO1	-2 to -8*	Duchesne et al. (2013)
<i>sigX</i> overexpression	PA14	4.4	Bochat et al. (2013)
Alkanes exposure	PseA (keratitis)	-**	Hemamalini and Khare (2014)

*Several isoforms were observed after 2DE.

**Fold change has not been indicated.

subjected to variations. Table 2 gives an overview of the several proteomic and transcriptomic studies in which *oprF* expression was found to be affected by a given condition. As already mentioned, OprF is 40-fold overproduced in anaerobic biofilm condition (Hassett et al. 2002) and in a synthetic medium (ASM) that mimics the environmental conditions found in the infected lung of CF patients, and which induces the formation of microcolonies (Sriramulu et al. 2005). However, a strongly reduced production of microcolonies and expression of *oprF* was observed when the same medium was deprived of amino acids, which are known to be present in the CF lung (Sriramulu et al. 2005). In the same article, production of the OprF protein was also shown to be highly increased in ASM containing amino acids using 2D protein gels, in line with the increased *oprF* transcription level. These results contrast with the data of a study using ASM in the strain PA14 where a 6-fold decrease of *oprF* expression was observed in biofilms formed after 96 h under anaerobic conditions (Tata et al. 2016). The conditions used in the two contrasting studies are however quite different: Sriramulu et al. grew the PAO1 strain in 24 wells in ASM under gentle agitation for 16 h, while Tata et al. used the strain PA14 and grew the cells under anaerobic conditions in the presence of KNO₃ and high concentrations of iron (100 μM) for 96 h.

Post-transcriptional regulation of *oprF*

In *E. coli*, the production of the OprF homolog OmpA is controlled at a post-transcriptional level by small non-coding RNAs (sncRNAs) MicA and RybB, binding to the Hfq RNA chaperone, ensuring a concerted expression of proteins involved in the control of outer membrane permeability (Johansen et al. 2006; Bossi and Figueroa-Bossi 2007; Udekwu and Wagner 2007). In *E. coli*, MicA is an antisense RNA of *ompA* mRNA, causing its destabilization in the presence of Hfq and the *micA* gene is under the control of RpoE ECF sigma, an AlgU homolog (Udekwu and Wagner 2007). In *E. coli* and *Salmonella*, the folding status of porins is monitored by the RpoE signaling system (Skovierova et al. 2006; Bossi and Figueroa-Bossi 2007). Although we do not know at this stage whether a similar situation occurs in the post-transcriptional regulation of porin genes in *P. aeruginosa*, it is

interesting to mention one report of a control of *oprF* mRNA translation via RsmA/RsmE in *P. fluorescens* CHAO (Crespo and Valverde 2009). It is therefore tempting to speculate for such a translational regulation of the *oprF* expression, in addition to the regulation of its transcription. However, one search for sRNAs in intergenic regions in the PAO1 genome failed to give any evidence of such small RNAs in the intergenic region between *sigX* and *oprF* (Gomez-Lozano et al. 2012). In a 2D-gel proteomic study comparing a wild-type *P. aeruginosa* PAO1 and its *sigX* mutant, it was found that the levels of some isoforms of OprF were decreased in the *sigX* mutant (Duchesne et al. 2013), suggesting also the existence of some post-translational modifications of the porin. Noticeably, the L-fucose-specific lectin LecB was shown to recognize OprF (Funken et al. 2012). In addition, considering that OprF is a sensor for human interferon gamma (IFN γ) (Wu et al. 2005), and that a fucosyl-residue is required for recognition of IFN γ by the receptor (Lundell and Narula 1994), it is possible that the fucose-specific LecB may act as an adaptor to mediate recognition of this cytokine by OprF on the bacterial surface (Funken et al. 2012). These data further suggest that OprF could be glycosylated, a hypothesis that is further strengthened by the recent assumption that OprF is a sialoglycoprotein having both 2,6- and 2,3-linkages (Khatua et al. 2014).

THE SMALL OprG PORIN

OprG with only eight β -strands is the second smallest *Pseudomonas aeruginosa* porin with a molecular mass of 25.2 kDa (Gensberg et al. 1999; McPhee et al. 2009; Touw, Patel and Van den Berg 2010). Its structure, presented in Fig. S1, shows the presence of large loops extending to the exterior of the outer membrane. OprG belongs to the OmpW family, which includes the *Escherichia coli* OmpW (Hong et al. 2006), *Caulobacter crescentus* OmpW (Benz et al. 2015) and the closest homolog OmpW from *Pseudomonas putida* (Walzer, Rosenberg and Ron 2009). OprG has been suggested to allow the transport of hydrophobic molecules via a lateral opening in the barrel wall (Touw, Patel and Van den Berg 2010). The OprG channel is however too small to allow the diffusion of small molecules like amino acids, despite that transport of alanine, glycine, serine and valine has been determined

in liposome swelling assays (Kucharska et al. 2015). Although the *oprG* mRNA is monocistronic, two of the upstream genes are involved in transport of amino acids and peptides (Kucharska et al. 2015). Another possible and likely function of OprG is the diffusion of Fe^{2+} under microaerobic conditions where this form of iron is predominant (Yates, Morris and Brown 1989). A strong support for the hypothesis that OprG might be involved in the diffusion of Fe^{2+} comes from the recent report on the involvement of *Acinetobacter baumannii* *OmpW*, an OprG homolog, in the transport of ferrous iron (Catel-Ferreira et al. 2016). Using an *oprG::xylE* fusion, McPhee et al. (2009) showed that the *oprG* gene transcription is induced by high iron levels under anaerobic conditions and that the Anr regulator is involved in this regulation. The presence of an Anr box 71 nucleotides upstream of *oprG* ATG was later confirmed (Trunk et al. 2010). The same authors confirmed a strong upregulation of *oprG* (20 x) under anaerobic growth conditions. More recently, using artificial medium mimicking CF lung conditions, i.e. low oxygen tension and high cell density, but in absence of added nitrate, other authors showed a strong decrease of *oprG* expression in a Δanr mutant compared to wild type in strains PAO1 (-18 x) and J215 (-35 x), confirming again the involvement of Anr in the regulation of *oprG* transcription (Hammond et al. 2015).

Zaborin et al. (2012) demonstrated the induction by opioids of virulence factors production by *P. aeruginosa* and one of the genes which was found to be expressed at higher level is *oprG*. In a RNA-seq study, Dötsch et al. (2012) found that the level of transcription of *oprG* is reduced by almost a factor 5 in 48-h biofilms of *P. aeruginosa* PA14 grown in LB medium compared to 4-h planktonic cells. In another study, Chua et al. (2014) obtained a different result since they found that *oprG* expression is higher (by a factor 3) in biofilms compared to planktonic cells. This discrepancy might originate from the different conditions used to grow biofilms, LB medium in the Dötsch et al. study and a minimal medium plus glucose by Chua et al. An interesting aspect of the last study is the effect of cells dispersal from biofilms, which revealed that biofilm dispersed cells are in a different physiological state compared to planktonic cells, characterized by a decreased production of the siderophore pyoverdine and an increased virulence (Chua et al. 2014). Treatment of planktonic cells with sodium nitroprusside (SNP), which is normally used to disperse biofilms, caused a decrease of expression of *oprG* by a factor 12 (Chua et al. 2014). Exposure to steady-state levels of H_2O_2 causes a decrease in *oprG* transcription by a factor 8 while no changes in the expression of other porin genes could be observed (Deng et al. 2014). In one study, exposure of *P. aeruginosa* cells to respiratory epithelial cells caused a decrease in the expression of *oprG* by a factor 4 (Chugani and Greenberg 2007). Finally, a transcriptome comparison of a spontaneous small colony variant (SCV) of *P. aeruginosa* PAO1 with the original wild type revealed a 3-fold decrease of *oprG* transcription in early stationary phase of growth (Wei et al. 2011). The ECF sigma factor SigX, already known as a regulator of *oprF*, has also been found to be involved in the regulation of *oprG*, via ChIP-seq, RNA-seq and supported by the presence of a conserved SigX binding motif (Schulz et al. 2015). Interestingly, a conserved binding motif for the FecI ECF sigma factor, involved in the regulation of uptake of ferric citrate (Potvin, Sanschagrin and Levesque 2008; Cornelis, Matthijs and Van Oeffelen 2009), has also been confirmed by ChIP-seq analysis, in further support of the suggestion of OprG involvement in iron homeostasis (Schulz et al. 2015) (Table 1).

Like six other porins (OprE/OccK8, OprD/OccD1, OprB, OprF, OprQ/OccD6 and OprH), OprG has been identified as a

component of OMVs produced by *P. aeruginosa* PAO1 in liquid cultures or in biofilms in three distinct proteome studies (Choi et al. 2011; Toyofuku et al. 2012; Couto et al. 2015). However, OprG is the only porin which has been identified as being under-represented in biofilm OMVs compared to outer membranes of the corresponding biofilm bacteria at two of the three studied time points (24 and 96 h, not at 48 h) (Park et al. 2015), but the significance of this observation remains unknown.

OprH, THE LOW-MAGNESIUM INDUCED PORIN AND ITS INVOLVEMENT IN ANTIBIOTIC RESISTANCE

OprH is the smallest of the *Pseudomonas aeruginosa* porins, with a mass of only 21.6 kDa. Similar to OprG, OprH has eight β -strands and its interaction with LPS has been demonstrated (Edrington et al. 2011; Kucharska et al. 2016) (Fig. 3A, Fig. S1). The *oprH* gene (PA1178) forms an operon with *phoP-phoQ* and PA1181 (Fig. 3B). In *P. aeruginosa*, the PhoP-PhoQ and the PmrA-PmrB two-component regulatory systems are known to be induced upon Mg^{2+} starvation and PhoP-PhoQ to directly upregulate the production of OprH, resulting in increased resistance to the polycationic antibiotic polymyxin B (Macfarlane et al. 1999; Macfarlane, Kwasnicka and Hancock 2000; McPhee et al. 2006; Wei et al. 2011; Olaitan, Morand and Rolain 2014). Polyamines have also been described to induce both the PhoP-PhoQ two-component system, the OprH porin and the PA3552-PA3559 LPS modification genes (*arn* genes), resulting in higher resistance to polymyxin and aminoglycosides (Kwon and Lu 2006). In agreement with this, addition of the polyamines agmatine and putrescine increases the level of *oprH* transcription by a factor of 9 and 7, respectively (Chou et al. 2008). Interestingly, the presence of high concentrations of Ca^{2+} ions has a strong negative effect (factor -58) on *phoP-phoQ* and hence on *oprH* expression (Guragain et al. 2016). The same authors found that calcium homeostasis is regulated by the CarSR two-component system and a phylogenetic analysis revealed that the CarR response regulator is closely related to PhoP, suggesting a possible cross-talk between magnesium and calcium homeostasis regulation (Guragain et al. 2016) (Fig. 3B). One possible explanation is that OprH stabilizes the outer membrane by interacting with LPS and that high levels of Ca^{2+} (or Mg^{2+}) could substitute for OprH by directly interacting with LPS, strengthening the outer membrane, hence causing a decreased abundance of OprH. In line with this hypothesis, Kreamer et al. identified a two-component system, BqsSR in *P. aeruginosa*, which responds to Fe^{2+} and promotes the expression of genes for cation tolerance, including genes for polyamine synthesis and uptake (Kreamer et al. 2012; Kreamer, Costa and Newman 2015). In their RNA-seq analysis, they demonstrated that the *phoPQ* operon including *oprH* is under the control of the BqsSR two-component system (Kreamer, Costa and Newman 2015). When reading the publication of Guragain et al., we were surprised to realize that CarSR and BqsSR are encoded by the same genes (PA2656 and PA2657 in strain PAO1), which indicates that the same two-component system responds to both calcium and ferrous iron, but in an inverse relationship. It is indeed puzzling that Fe^{2+} shock results in an increased *oprH* expression (Kreamer, Costa and Newman 2015) while high concentrations of Ca^{2+} cause a decrease in the level of transcription of the *oprH* gene (Guragain et al. 2016). One possible explanation is that the two cations cause different degrees of phosphorylation of the sensor and the response regulator, a hypothesis worth investigating in the future.

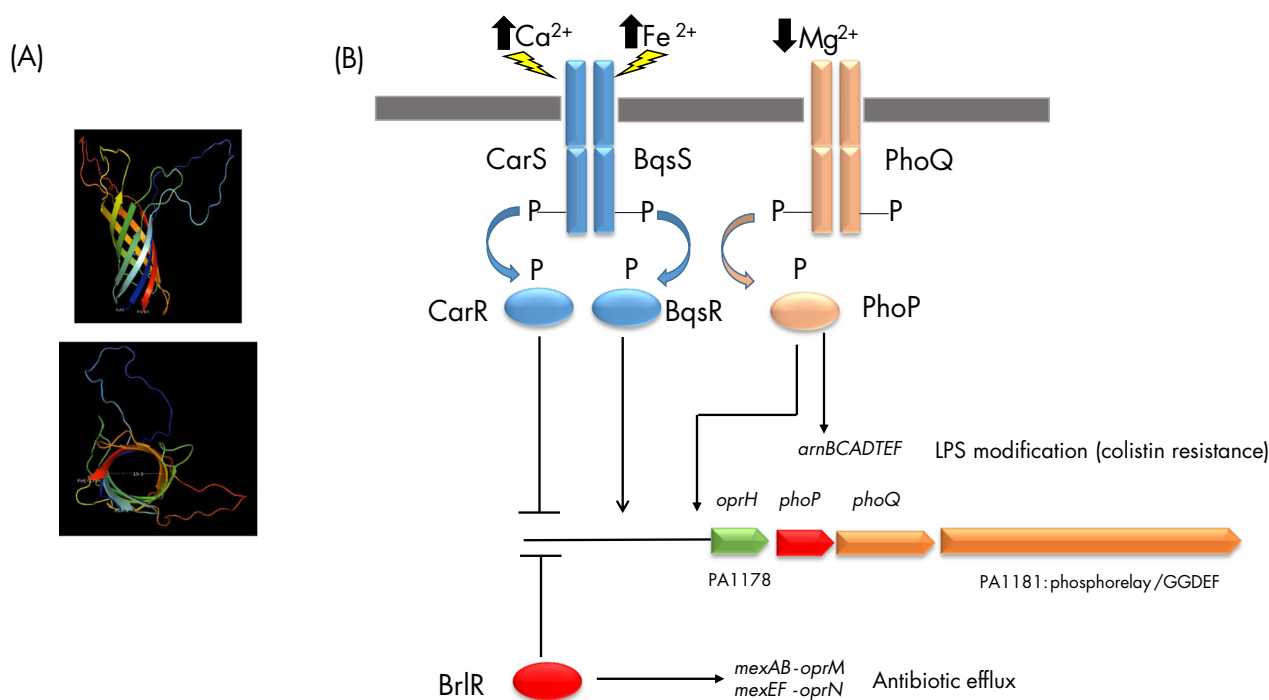

Figure 3. OprH structure scheme and regulation of *oprH* transcription. (A) Schematic representation (PyMOL Molecular Graphics System, Version 1.8 Schrödinger, LLC) viewed from the side (top) and from the extracellular environment (bottom) of OprH based on a 3D model predicted by I-TASSER (Yang and Zhang 2015; Yang et al. 2015). (B) Low level of Mg²⁺ is perceived by the TCS PhoP/PhoQ, in which the sensor PhoQ is submitted to autophosphorylation, leading to phosphorylation of its cognate regulator PhoP. The operon *oprH/phoP/phoQ/PA1181* is subjected to a positive feedback since the *oprH* promoter region is a direct target of PhoP. In addition, perception of high levels of Ca²⁺ or Fe²⁺ by CarS/BqsS, respectively, converge on CarR/BqsR, which acts as a negative and positive regulator, respectively, on *oprH* transcription. Finally, the c-di-GMP responsive transcription factor BrIR is a negative regulator of the *oprH* operon. Taken together, these data suggest that regulation of *oprH-phoP-phoQ-PA1181* is closely related to antibiotic resistance, since *arnBCADTEF* that is involved in LPS modification leading to colistin resistance is positively regulated by PhoP, and BrIR is a positive transcriptional regulator of the two major efflux pumps MexAB-OprM and MexEF-OprN. In addition, PA1181 is a predicted c-di-GMP cyclase, suggesting a link between *oprH-phoP-phoQ-PA1181* and biofilm formation. Remarkably, PA1181 was shown to belong to the SigX regulon (Blanka et al. 2014), a newly proposed cell wall stress responsive sigma factor.

In a study on a spontaneous gentamycin-resistant SCV of *P. aeruginosa* strain PAO1, Wei et al. (2011) found larger amounts of the OprH protein in the SCV compared to the wild type, in agreement with the transcriptomic data showing an increased expression of the *oprH* gene in both early (4-fold) and late stationary phase of growth (5-fold). This effect was probably the result of a 39-bp deletion in the *phoQ* sensor open reading frame, which could explain the higher expression of PhoP-dependent genes, including *oprH* (Wei et al. 2011).

BrIR, a c-di-GMP-binding MerR-like regulator, which is known to be an activator of antibiotic efflux pumps (Liao and Sauer 2012; Liao, Schurr and Sauer 2013; Chambers et al. 2014), was found to repress the expression of the *oprH-phoP-phoQ-PA1181* operon by binding directly upstream of the *oprH* gene, resulting in increased sensitivity to colistin (Chambers and Sauer 2013). When *P. aeruginosa* is in contact with bronchial epithelial cells, expression of the *oprH-phoP-phoQ* operon is strongly enhanced, by a factor more than 5000 in one study (Gellatly et al. 2012) whereas an earlier report by Chugani and Greenberg (2007) showed a decreased expression of *oprH* upon contact with lung epithelial cells. This apparent contradiction could be explained by the different approaches used in the two studies: while Chugani and Greenberg looked at the global gene expression upon contact with epithelial cells, Gellatly et al. specifically looked at the expression of epithelium adherent cells. To add to the complexity of *oprH* expression regulation, the RpoS sigma factor was found by ChIP-seq analysis to bind the upstream intergenic region, which was confirmed by the

presence of a conserved RpoS binding motif (Schulz et al. 2015) (Table 1).

Recently, it has been demonstrated that OprH binds the surfactant protein A (SP-A), a lung lectin of the collectin family involved in innate immunity by promoting the bacteria clearance via phagocytosis by alveolar macrophages (Qadi et al. 2016). Direct binding of SP-A to OprH was also confirmed by fluorescent ligand binding (Qadi et al. 2016).

THE GLUCOSE-SPECIFIC PORIN GENES *oprB* AND *oprB2*

The *oprB* gene encodes a glucose-specific porin with 18 β -sheets (Wylie and Worobec 1994, 1995) (Fig. 4A) and is in an operon with four other genes, forming the *gltBFGKoprB* operon as predicted in the Pseudomonas.com database (Winsor et al. 2016) by the DOOR prokaryotic operon prediction tool (Mao et al. 2009) (Fig. 4B). GltB is predicted to be a periplasmic binding protein (Lewenza et al. 2005) and the *gltFGK* genes encode the components of an ABC transporter, GltF and GltG forming a sugar permease while GltK is the ATP binding subunit of the transporter. Although not predicted to be in the same operon, the upstream genes are probably involved in the regulation of glucose uptake as well. The *gtrS* gene is separated by a large intergenic region (523 nucleotides) from *gltB* and it encodes together with the neighboring gene *gltR* a glucose-sensitive two-component system in which GtrS and GltR are the histidine kinase and the response regulator,

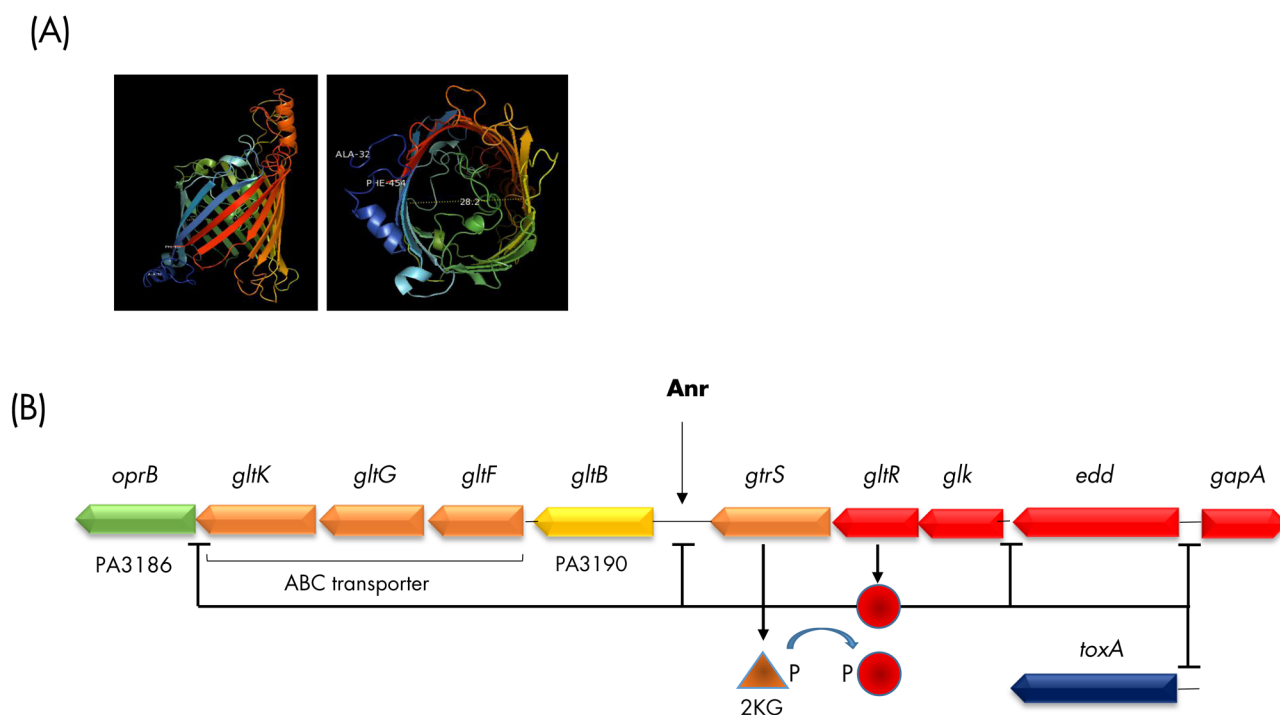

Figure 4. OprB structure and regulation of *oprB* transcription. (A) Schematic representation (PyMOL Molecular Graphics System, Version 1.8 Schrödinger, LLC) viewed from the side (left) and from the extracellular environment (right) of OprB based on a 3D model predicted by I-TASSER (Yang and Zhang 2015; Yang et al. 2015). (B) Sensing of 2 ketogluconate (2KG) by the histidine kinase GtrS results in phosphorylation of the GltR transcriptional regulator, which in turn negatively affects transcription of *oprB*, PA3190, *glk* and *gapA*, these genes lying in the close vicinity of the TCS encoding genes. In addition, GltR is also a negative regulator of *toxA* expression, suggesting a relation between glucose metabolism and virulence in *P. aeruginosa*.

respectively (Sage, Proctor and Phibbs 1996; O'Callaghan et al. 2012; Daddaoua et al. 2014). The first gene of this second operon is *edd* encoding the phosphogluconate dehydratase, forming the *edd-glk-gltR-gtrS* predicted operon (Mao et al. 2009). Upstream of the *edd* gene, and in the opposite direction, the *gapA* gene leads to a monocistronic mRNA and encodes the glyceraldehyde triphosphate dehydrogenase. The response regulator GltR acts at three promoters, upstream of the *edd*, the *glk* and the *oprB* genes (Fig. 4B). The GtrS protein is more abundant when the cells have been exposed to epithelial cells and inactivation of the *gtrS* gene leads to a reduced cytotoxicity towards airway epithelial cell line, in line with the finding that the GtrS-GltR two-component system is involved in the induction of type III secretion system in *Pseudomonas aeruginosa* (O'Callaghan et al. 2012). It was also determined that this effect on type III secretion was partly dependent on OprB, linking *oprB* expression and virulence in *P. aeruginosa* since GltR also regulates the *toxA* gene for exotoxin A production (O'Callaghan et al. 2012; Daddaoua et al. 2014). It is also worth to mention that exposure to human respiratory epithelial cells results in increased expression of *oprB* by a factor of almost 4 (Chugani and Greenberg 2007). Another regulator, Anr, which regulates the shift from aerobiosis to anaerobiosis, also binds to a region upstream of the *gltB* gene, positively regulating its expression (Trunk et al. 2010).

The expression of *oprB* was found to be strongly downregulated (more than 50 times) in 96-h biofilms compared to planktonic cells under anoxic conditions (Tata et al. 2016). In a proteomic analysis, Duchesne et al. (2013) found that the SigX ECF sigma factor has also a positive effect on the level of the OprB porin production. The expression of *oprB* has also been found to be downregulated in the presence of ASM (Fung et al. 2010). In their survey of sigma factors regulons (sigmulons), Schulz

et al. (2015) found one RpoS-binding motif upstream of *oprB*, supported by the results of their RNA-seq analysis (Table 1). In the genome of *P. aeruginosa* PAO1, there is a second gene, *oprB2*, coding for a protein of same size, which is 95% identical to OprB. This gene is predicted to be in an operon with the *gcd* gene encoding the glucose dehydrogenase and a gene (PA2289) encoding a TonB-dependent receptor. Interestingly, this TonB-dependent outer membrane receptor is not predicted to be regulated by an ECF sigma factor or by Fur, suggesting that it is not involved in iron uptake (Cornelis, Matthijs and Van Oeffelen 2009). The function of *oprB2* and its neighboring genes is presently unknown.

THE OprO AND OprP PHOSPHATE-SPECIFIC PORINS

Both porin genes are transcribed as monocistronic mRNAs and follow each other (*oprP*: PA3279, *oprO*: PA3280) (Winsor et al. 2016). The two proteins share a high degree of similarity (76% identity and 16 conservative substitutions) (Siehnel, Egli and Hancock 1992) and are immunologically cross-reactive (Hancock et al. 1992). Their structures are also highly similar and the crystal structure of OprP has been solved at a 1.9 Å resolution (Moraes et al. 2007) (Fig. 5A, Fig. S1). Despite this high level of similarity, even at structural level, the two porins display different specificities, since OprP shows a preference for Pi monophosphate while OprO is more specific for di- and poly-phosphates (Hancock et al. 1992). The protein has an arginine ladder extending from the extracellular surface down to a constriction zone where Pi is coordinated while lysine residues coat the inner periplasmic surface (Moraes et al. 2007; Pongprayoon et al. 2009). There are two adjacent binding sites for Pi, W1 and W2, in OprP and the higher

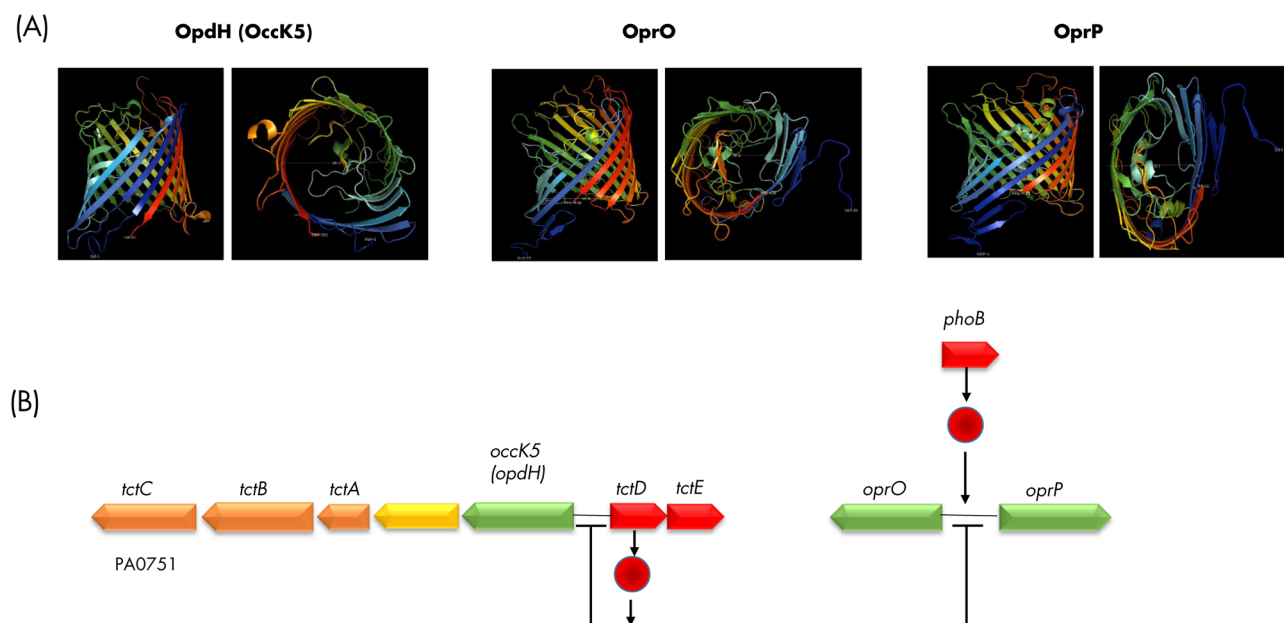

Figure 5. OprO, OprP and OpdH (OccD5), structure and regulation. (A) Schematic representation (PyMOL Molecular Graphics System, Version 1.8 Schrödinger, LLC) viewed from the side (left) and from the extracellular environment (right) of OpdH and OprP based on their X-ray crystal structure (PDB 3T20 and 2O4V, respectively), and of OprO based on a 3D model predicted by I-TASSER (Yang and Zhang 2015; Yang et al. 2015). (B) PhoB is a positive regulator of *oprO* and *oprP* expression. By contrast, TctD is a repressor of *oprO* and *oprP*, as well as of its own expression and that of *opdH* (*occD5*). In presence of the OpdH (OccD5) substrate, *cis*-aconitate, the repression exerted by TctD is alleviated, leading to transcription of *opdH* (*occD5*)-*tctA*-*tctB*-*tctC*, *tctD*-*tctE* operons, *oprO* and *oprP*.

selectivity for phosphate compared to chloride is conferred by the lysine residues (Pongprayoon et al. 2009). Interestingly, there is as well an aspartate residue (D94) in the binding site, which seems counterintuitive, but mutation to a positively charged residue leads to a higher affinity binding of phosphate, but causes a decreased release of the ligand; the role of this aspartate residue is therefore proposed to decrease the residence time of Pi (Modi et al. 2015).

As already mentioned, OprO is a channel for P_i while OprP binds preferentially Pi. The difference is to be found by the presence in the central constriction of two tyrosine residues in OprP (Y62 and Y114) while in OprO there is a phenylalanine at position 62 and an aspartate at position 114. Interestingly, permutations of these amino acids between the two phosphate porins resulted in changed specificities (Modi et al. 2015). Both *oprO* and *oprP* genes are upregulated when phosphate is limiting and upon binding of the PhoB regulator to *pho* boxes upstream of the two porin genes (Siehnel, Worobec and Hancock 1988; Siehnel, Egli and Hancock 1992). Reciprocally, *oprO* and *oprP* are downregulated in a mutant deleted of *phoB* compared to wild type (Bielecki et al. 2015). Another regulator, TctD, was found to control genes belonging to the PhoB regulon, including *oprO*, which is positively regulated by PhoB, but negatively by TctD (Bielecki et al. 2015). Interestingly, TctD is a regulator of the *opdH**tctCBA* (*occK5*) operon where it acts as a repressor in the absence of the specific porin substrate (Tamber et al. 2007; Bielecki et al. 2015) (Fig. 5B).

Both *oprP* and *oprO* are upregulated when *P. aeruginosa* is in contact with lung epithelial cells, although this effect is even more pronounced in the case of *oprO* (by a factor 143 versus 10 for *oprP*) (Chugani and Greenberg 2007). In a study comparing the gene expression of *P. aeruginosa* PA14 cells in a healthy volunteer blood or in burn patients blood, it was found that in the last condition both *oprP* and *oprO* are downregulated (−8 x and −50 x, respectively) as well as the components of the PhoB regulon (Kruczek et al. 2016), suggesting that this downregulation

is PhoB dependent. In line with this, both genes' expression is downregulated in a mutant deleted of *phoB* compared to wild type (Bielecki et al. 2015). The RpoH sigma factor involvement in the regulation of *oprP* (and probably *oprO*) has been detected by ChIP-seq and the presence of an RpoH-binding motif has been confirmed (Schulz et al. 2015) (Table 1).

THE OprD (OccD1) BASIC AMINO ACID PORIN

OprD (OccD1) represents the second major porin protein in the outer membrane of *Pseudomonas aeruginosa* (Fig. 6A) and is also one of the most investigated because of its involvement in the entry of carbapenem antibiotics, especially imipenem and meropenem (Trias and Nikaido 1990a,b; Quinn et al. 1991; Yoneyama, Yamano and Nakae 1995). That OprD (OccD1) serves as the gate through which imipenem enters the *P. aeruginosa* cell was suspected by the analysis of imipenem-resistant mutants which did not produce detectable amount of the porin as observed by western blot analysis (Yoneyama and Nakae 1993; Wolter, Hanson and Lister 2004).

The first identified real physiological function of OprD (OccD1) was the transport of basic amino acids (arginine, lysine, histidine, ornithine) and peptides such as Ala-Lys, Lys-Ala, Thr-Ser-Lys or Pro-Phe-Gly-Lys, but not Thr-Lys-Pro, suggesting that peptides containing an internal charged amino acid are not taken up (Trias and Nikaido 1990a). It has also been suggested that OprD (OccD1) could be involved in the uptake of gluconate, but not glucose (Huang and Hancock 1993). The porin, reconstituted in planar lipid bilayers, bound imipenem via its second external loop (Huang and Hancock 1996). Mutations resulting in non-expression of *oprD* (*occD1*) result in imipenem resistance, but other mutations involving amino acid substitutions without affecting transcription also cause carbapenem resistance (Richardot et al. 2015). Recently, it was found that an in-frame deletion within the *oprD* (*occD1*) gene led to

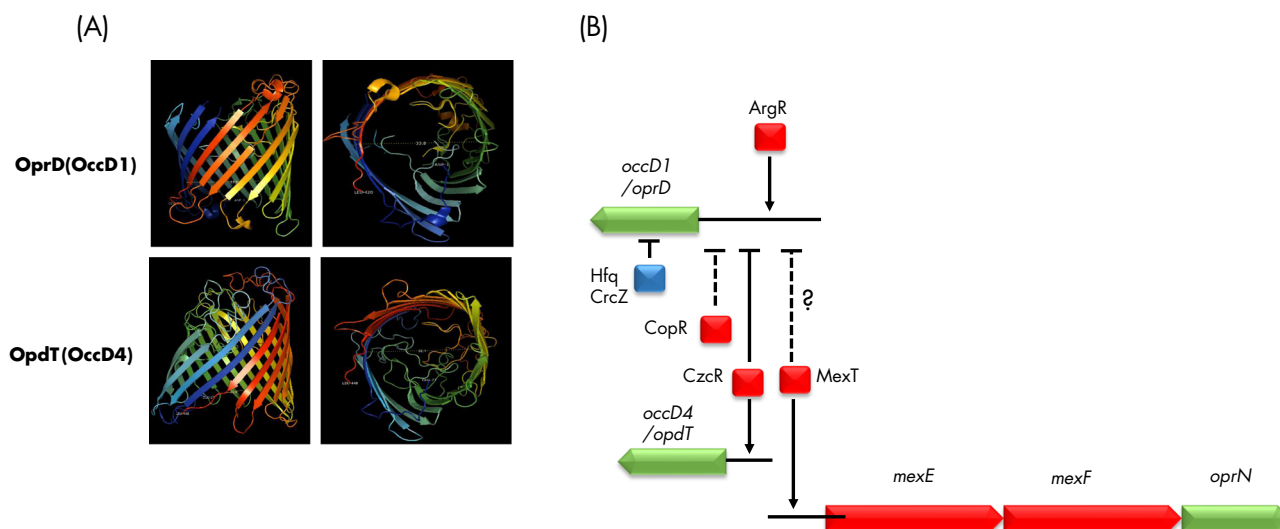

Figure 6. Regulation of *oprD* (*occD1*) and *opdT* (*occD4*). (A) Schematic representation (PyMOL Molecular Graphics System, Version 1.8 Schrödinger, LLC) viewed from the side (left) and from the extracellular environment (right) of OprD (OccD1) based on its X-ray crystal structure (PDB 4FOZ), and of OpdT (OccD4) based on a 3D model predicted by I-TASSER (Yang and Zhang 2015; Yang et al. 2015). (B) Expression of *oprD* (*occD1*) is activated via the arginine responsive regulator ArgR and repressed directly by the zinc responsive CzcR. Repression of *oprD* (*occD1*) transcription by the copper-sensitive regulator CopR and by MexT, the activator of the *mexEF-oprN* efflux pump encoding genes, is suspected. Furthermore, regulation occurs as well at a post-transcriptional level involving the small RNA CrcZ and the Hfq RNA chaperone (in blue).

expression of a smaller protein, which resulted in carbapenem resistance while the capacity of transporting arginine was maintained (Kos, McLaughlin and Gardner 2016), although this could be due to the involvement of a second porin (OpdP/OccD3) in the uptake of arginine (see below). Although both meropenem and imipenem can be bound by the porin, mutants devoid of *oprD* (*occD1*) were only resistant to imipenem, but had an unchanged susceptibility to meropenem, suggesting the existence of an alternative uptake route for this last antibiotic (Perez et al. 1996).

OprD (OccD1) was the protein showing the greatest over-representation in OMVs from biofilm samples compared to the outer membrane of bacteria at all three investigated time points (Park et al. 2015). This over-representation was specific of the biofilm lifestyle since OprD (OccD1) was not specifically over-represented in planktonic OMVs. The authors proposed that packaging OprD (OccD1) into biofilm OMVs might be a way for *P. aeruginosa* to reduce the porin levels in its outer membrane, thereby lowering the bacterial sensitivity to carbapenem (Park et al. 2015). In *Escherichia coli*, OMVs were shown to protect bacteria from polymyxin B and colistin by adsorbing these antimicrobial peptides (Manning and Kuehn 2011). One could similarly hypothesize that high OprD (OccD1) levels in OMVs deplete OprD in the outer membrane, allowing carbapenem accumulation into OMVs, and lowering the concentration of free carbapenem in bacterial cells.

Purified OprD (OccD1) also displayed a protease activity while an amino acid triad characteristic of serine proteases (His, Asp, Ser) was identified and mutants constructed by site directed mutagenesis confirmed the protease activity of the porin (Yoshihara et al. 1996, 1998). The structure of OprD (OccD1) has been determined, and, like in other members of the OccD/OprD family, it has 18 β -sheets and a constricted narrow pore containing a positively charged amino acids ladder on one side and another region of electronegative charged pocket on the other side (Biswas et al. 2007). The production of OprD (OccD1) is induced by arginine, glutamate or alanine as sole carbon sources when the cells are grown in minimal medium (Ochs et al. 1999b). The presence of the preferred carbon source succinate suppressed

this induction, suggesting the involvement of a catabolite suppression mechanism (Ochs et al. 1999a).

The AraC family ArgR regulator was found by electrophoretic mobility shift assay to bind to the operator sequence of *oprD* (*occD1*) and ArgR protected a 47-bp region from DNase I digestion, which included a consensus binding site for the regulator (Ochs et al. 1999a) (Fig. 6B, Table 1). Although the induction of *oprD* (*occD1*) by arginine was lost in an *argR* mutant, the glutamate-induced induction was still observed suggesting an alternative regulatory mechanism (Ochs et al. 1999a). MexT, a LysR family regulator, is an activator of the *mexEF-oprN* efflux pump and its overexpression has an inverse effect on *oprD* (*occD1*) expression, a phenomenon first observed in *nfxC* mutants, which were further identified as being mutants overexpressing the efflux pump (Kohler et al. 1999a,b) (Fig. 6B). Exposure to copper or zinc was found to cause a decrease in *oprD* (*occD1*) expression and led to undetectable levels of OprD (OccD1) protein (Caille, Rossier and Perron 2007). In 96-h biofilms grown under anoxic conditions, a strong decrease of *oprD* (*occD1*) expression was observed, which could partly explain the higher resistance to meropenems of biofilms (Tata et al. 2016). A similar effect, i.e. decreased expression of *oprD* (*occD1*), was observed in 48-h biofilms compared to planktonic cells (Dötsch et al. 2012). In line with this observation, a strong decrease in *oprD* (*occD1*) expression is observed in chronic wounds compared to MOPS-succinate grown cells (Turner et al. 2015).

The *P. aeruginosa* two-component CzcSR system is induced after exposure to metals and is involved in the resistance against copper and zinc via the induction of the CzcCBA metal efflux pump (Caille, Rossier and Perron 2007). Overproduction of CzcR after exposure to zinc and of another regulator involved in copper resistance, CopR, resulted in strongly decreased production of OprD (OccD1), the effect being stronger at post-transcriptional compared to transcriptional level (Caille, Rossier and Perron 2007). Using chromosome immunoprecipitation experiments (ChIP), it was demonstrated that CzcR directly binds in the control region of *oprD*, clearly establishing CzcR as a negative regulator of *oprD* (Dieppois et al. 2012) (Fig. 6B, Table 1). More recently, it has been shown that the Hfq RNA chaperone is

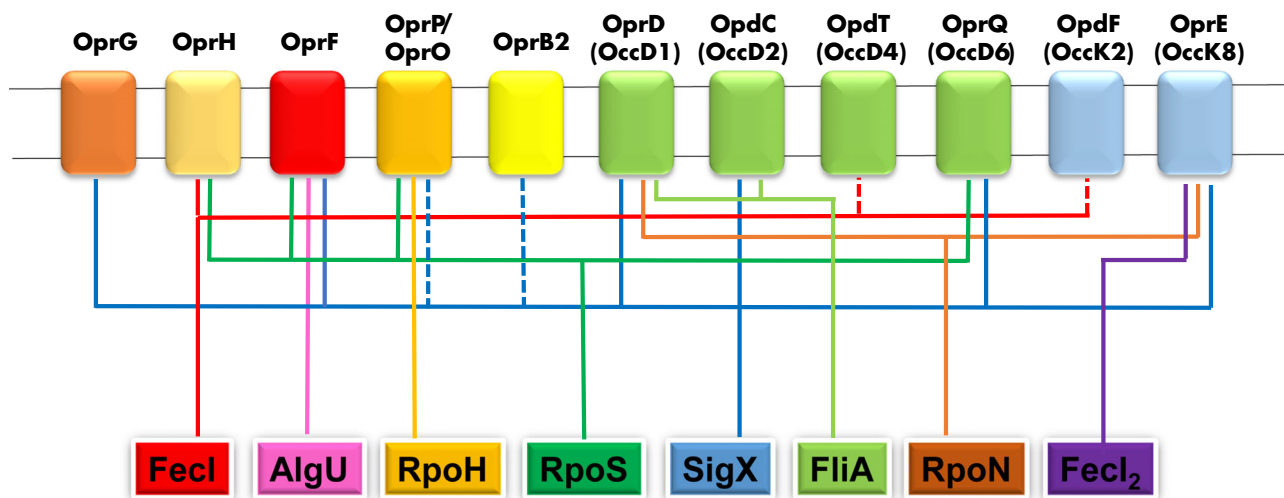

Figure 7. Regulation of porin genes by sigma factors. The involvement of Fecl1, Fecl2, AlgU, RpoH, RpoS, SigX, FliA and RpoN sigma factors in regulation of porin genes is indicated by the corresponding colored lines, according to ChIP data (Schulz et al. 2015).

required for binding of the CzcR regulator to the operator region of the porin gene (Ducret et al. 2016). Hfq binds preferentially to the CrcZ small RNA in *P. aeruginosa* PA14 and deletion of *hfq* leads to overexpression of *oprD* (*occD1*) as well as *oprQ* (*occD6*), suggesting a dual level of regulation, transcriptional via CzcR and post-transcriptional via the small RNA CrcZ and Hfq (Ducret et al. 2016; Pusic et al. 2016) (Fig. 6B, Table 1).

Twenty-six 2,3- and 2,6-linked sialoglycoproteins have been detected in *P. aeruginosa* exposed to human serum, and OprD (OccD1) is one of them, the others being OprG, OprF and OprQ (OccD6) (Khatua et al. 2014). Interestingly, OprD (OccD1) sialylation has been found to impair its interaction with β -lactam antibiotics (Khatua et al. 2014). Analysis of 55 clinical and environmental *P. aeruginosa* isolates *oprD* (*occD1*) sequences revealed a mosaic structure of OprD (OccD1) where stretches of sequences have apparently been exchanged, and, in one isolate, an important sequence variability typical of a hypermutator phenotype has been observed (Pirnay et al. 2002).

Surprisingly, using a high-throughput Tn-seq analysis of *P. aeruginosa* PA14 strains, a vast majority of mutants with higher dissemination in a mouse model of infection were observed to lack *oprD* (*occD1*) expression, which not only did result in carbapenem resistance, but also in increased *in vivo* fitness (Skurnik et al. 2013). Strains lacking *oprD* (*occD1*) expression also showed higher resistance to low pH or normal human serum exposure while having an increased cytotoxicity towards human macrophages (Skurnik et al. 2013). This increased fitness is remarkably only observed for insertions in *oprD* (*occD1*) since all other Tn insertions in all the other outer membrane protein genes resulted in decreased rather than increased *in vivo* fitness (Skurnik et al. 2013). A RNA-seq analysis of PA14 wild type and Tn-*oprD* mutant did not reveal differences in expressed genes *in vitro*, while *in vivo* 97 genes were found to be silent in the mutant and, conversely, 60 genes had transcription levels increased more than 10-fold in the mutant (Skurnik et al. 2013). Interestingly, the *oprF*, *oprG* and *oprQ* (*occD6*) genes were more than 10 times more expressed in the *oprD* (*occD1*) mutant strain in the *in vivo* situation (Skurnik et al. 2013). In this context, it is tempting to link this observation with the fact that OprF is needed for full virulence of *P. aeruginosa* (Fito-Boncompagni et al. 2011), which could partly explain why the *oprD* (*occD1*) mutant is more

invasive and virulent. Similarly to OprF, whose production is lowered in a *sigX* mutant, the levels of the OprD (OccD1) protein were also found to be strongly decreased in a proteomic analysis comparing the Δ *sigX* and WT *P. aeruginosa* PAO1 (Duchesne et al. 2013). The same decrease in *oprD* (*occD1*) transcription was observed in a transcriptome analysis comparing the *sigX* mutant versus the wild type (Gicquel et al. 2013). The involvement of SigX in *oprD* (*occD1*) transcription has been further suggested by ChIP-seq and a motif was detected in the *oprD* (*occD1*) promoter region (Schulz et al. 2015) (Fig. 7). Finally, the involvement of RpoN sigma factor in the regulation of *oprD* (*occD1*) expression has been determined by ChIP-seq and RNA-seq analysis although no characteristic motif could be detected (Schulz et al. 2015) (Table 1, Fig. 7).

THE OTHER MEMBERS OF THE OprD/Occ FAMILY OF PORINS

The proteins of the members of the OprD (Occ) family share a high degree of similarity (46%–57%) (Fig. 8), but they show different substrate specificities (Tamber and Hancock 2006; Tamber, Ochs and Hancock 2006). In one study, eight porin genes belonging to the OprD (Occ) family were tested for their substrate specificity using nine different compounds (glucose, cis-aconitate, arginine, glycine-glutamate, pyroglutamate, tyrosine, vanillate, proline and histidine) (Tamber, Ochs and Hancock 2006). The three porin genes corresponding to the OpdK (OccK) subfamily (Fig. 8), *opdH* (*occK5*), *opdK* (*occK1*) and *opdO* (*occK3*), were specifically induced by their respective substrates (cis-aconitate and vanillate for *opdH* (*occK5*), vanillate for *opdK* (*occK1*) and pyroglutamate for *opdO* (*occK3*) (Tamber, Ochs and Hancock 2006). Conversely, the five genes corresponding to members of the OprD/OccD subfamily, *oprD* (*occD1*), *opdP* (*occD3*), *opdC* (*occD2*), *opdB* (*occD7*) and *opdT* (*occD4*), showed a constitutive expression in the presence of all the tested substrates, with a slightly higher induction of *opdP* (*occD3*) in the presence of arginine (Tamber and Hancock 2006; Tamber, Ochs and Hancock 2006). Interestingly, OpdP (OccD3) shows the highest percentage of similarity with OprD (OccD1) (51%), suggesting that it could compensate for the absence of OprD (OccD1) for the uptake of arginine. This was confirmed by the observation that a double *oprD/opdP*

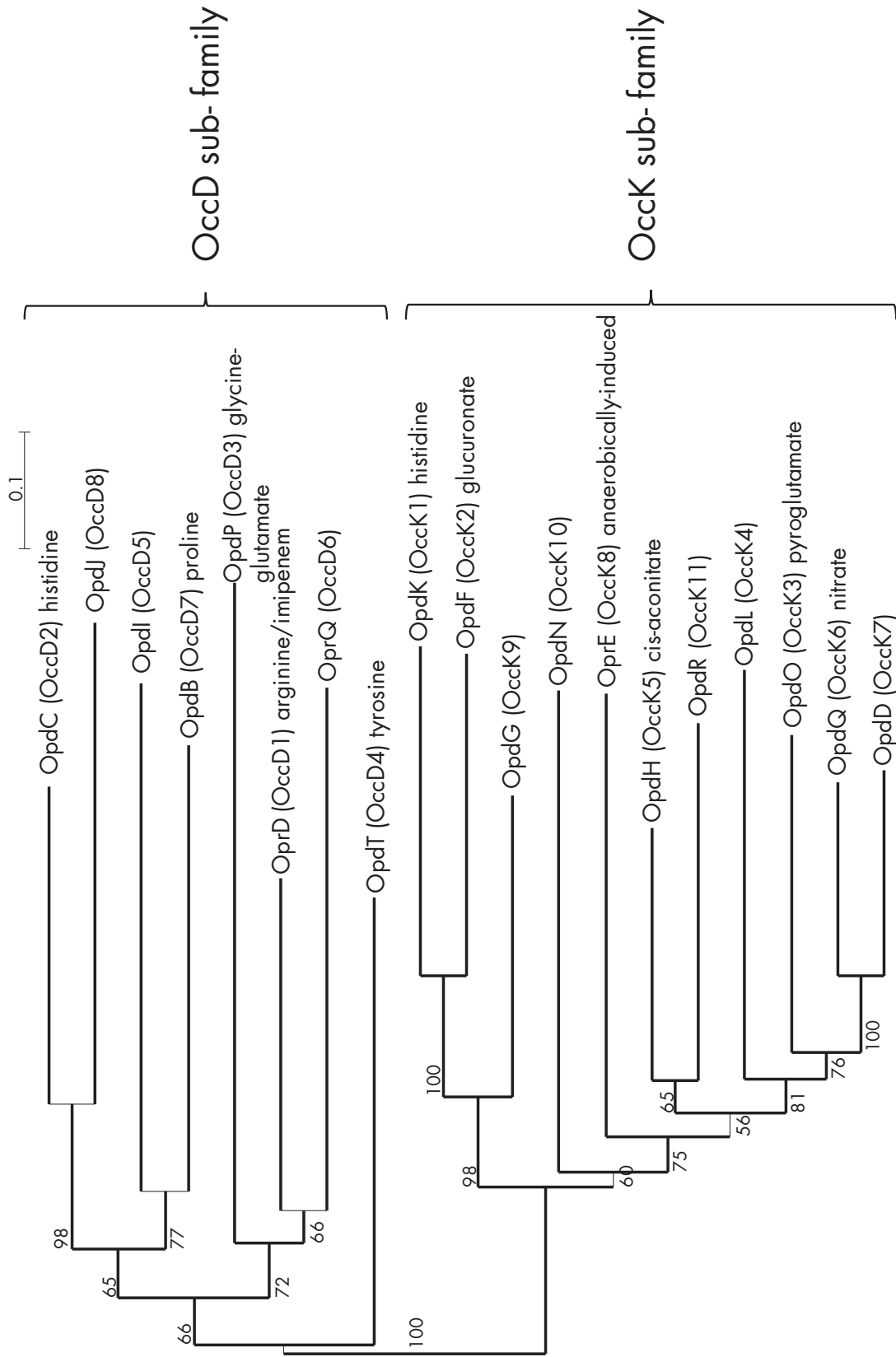

Figure 8. Phylogenetic relationships among OccD and OccK sequences from *P. aeruginosa* PAO1. The unrooted dendrogram was generated using neighbor-joining algorithm from evolutionary distances using Poisson correction. Bootstrap values correspond to 1000 pseudo-replicates.

(*occD1/occD3*) mutant grew less well in the presence of arginine as a carbon source compared to single mutants or to the wild type, which was further confirmed by a reduced uptake of radiolabeled arginine by the double mutant (Tamber and Hancock 2006). These results suggest that (i) the members of the OpcK (OccK) subfamily may have evolved a stricter substrate specificity, despite the presence of a larger pore in the members of this family (Eren et al. 2012, 2013), and (ii) there is some substrate utilization redundancy between the porins of the OccD subfamily, similar to what is observed among the members of the TonB-dependent siderophore receptors (Ghysels et al. 2004, 2005). Further characterization of OpcH (OccK5), the porin which is induced by *cis*-aconitate, confirmed the gene expression induction by *cis*-aconitate, but also by isocitrate and citrate (Tamber et al. 2007). The *opdH* (*occK5*) gene is the first of an operon with *tctCBA* where TctC is a periplasmic binding protein and the TctB and TctA proteins are the inner membrane components of a tri-carboxylate transporter (Fig. 5B). Transcribed in the opposite orientation are the two genes, *tctDE*, corresponding to a two-component system. Inactivation of *tctD* encoding the response regulator caused a derepression of the *opdH* (*occK5*) operon in the absence of inducer, although it did not result in the entire suppression of the induction by the substrate of OpcH (OccK5), suggesting another level of regulation (Tamber et al. 2007). It is of interest to mention that SigX also regulates the *opdC* (*occD2*) gene, as evidenced by ChIP-seq, RNA-seq and the presence of the SigX motif (Schulz et al. 2015), while *opdP* (*occD3*) expression has been proposed to depend on RpoN, although not demonstrated by ChIP-seq (Table 1, Fig. 7).

OprQ (OccD6)

Despite a high level of similarity with OprD (OccD1) (>50%), OprQ (OccD6), contrary to OprD (OccD1), has no role in antibiotic resistance (Okamoto et al. 1999). Later on it was found that a *P. aeruginosa* mutant with an *oprQ* (*occD6*) gene disruption had a surprisingly stronger growth phenotype compared to the wild type in LB and in minimal M63 media while the mutant complemented with *oprQ* (*occD6*) *in trans* had growth characteristics undistinguishable from the wild type (Arhin and Boucher 2010). Interestingly, overproduction of *oprQ* (*occD6*) resulted in moderately increased sensitivity to some antibiotics (Arhin and Boucher 2010). The same authors showed that low magnesium increased the expression of *oprQ* (*occD6*) by a factor of 5 while a 13-fold increase was observed under low-iron conditions in minimal medium (Arhin and Boucher 2010). When planktonic *P. aeruginosa* PA14 cells are exposed for 30 min to anoxic conditions in CF sputum medium, a four-time upregulation of *oprQ* (*occD6*) was observed (Tata et al. 2016). In a gentamicin-resistant SCV of PAO1, *oprQ* (*occD6*) transcription is increased by a factor 4 compared to the wild type in late stationary phase (Wei et al. 2011). Jaouen et al. (2006) observed that a *P. fluorescens* *oprQ* (*occD6*) mutant could not anymore bind to the extracellular matrix fibronectin. The same observation could be made for the OprQ (OccD6) ortholog in *P. aeruginosa* since an *oprQ* (*occD6*) mutant could not bind to fibronectin anymore while a mutant complemented *in trans* with *oprQ* (*occD6*) had a restored binding capacity, especially after IPTG induction of the *oprQ* (*occD6*) expression (Arhin and Boucher 2010). This result suggests that OprQ (OccD6) is contributing to the human host colonization. Another interesting observation is that *oprQ* (*occD6*) disruption results in increased production of the phenazine pigment pyocyanin, which is known to contribute to virulence (Arhin and Boucher 2010). As

already mentioned, an *oprD* (*occD1*) deletion mutant showed an increased expression of other porin genes, including *oprQ* (*occD6*) (Skurnik et al. 2013). Interestingly, a coregulation of the two porin genes *oprD* (*occD1*) and *oprQ* (*occD6*) has also recently been observed since both genes are overexpressed in a Hfq mutant of *P. aeruginosa* (Pusic et al. 2016). The two ECF sigma factors RpoS and SigX have been shown to bind the regulatory region upstream of *oprQ* (Fig. 7) (Schulz et al. 2015).

OprE (OccK8)

The *oprE* (*occK8*) gene is transcribed as a single gene unit and codes for a 49.7 kDa porin first mentioned as being induced by anaerobic conditions (Yamano, Nishikawa and Komatsu 1993). It was later shown that deficiency in the alternative sigma factor RpoN resulted in non-expression of the porin both at transcription and protein levels under aerobic conditions, although it had no effect on the expression of *oprE* (*occK8*) when the cells were grown under anaerobic conditions (Yamano, Nishikawa and Komatsu 1998). Recently, the involvement of RpoN sigma factor in the regulation of *oprE* (*occK8*) has been confirmed via ChIP-seq analysis (Schulz et al. 2015) (Fig. 7) (Table 1). In a proteomic study, OprE (OccK8) production was found to be increased after exposition to alkanes, which makes sense because oxygen availability is reduced under these growth conditions (Hemamalini and Khare 2014). Interestingly, under the same conditions of alkanes exposure, the production of OprF and OprD (OccD1) is also reduced (Hemamalini and Khare 2014). A putative binding site for the LysR regulator OxyR has also been detected in the intergenic region upstream of *oprE* (*occK8*) by chromatin immunoprecipitation (Wei et al. 2012). Like OprD (OccD1), OprE (OccK8) is over-represented in OMVs from biofilm samples compared to the outer membrane of the corresponding bacteria at all three investigated time points (Park et al. 2015).

OpcK (OccK1)

OpcK (OccK1), which belongs to the OccK subfamily, is involved in the uptake of vanillate, and its structure has been determined (Fig. S1); it has 18 β -strands with a kidney-shaped central pore, and was found to form trimers in the outer membrane (Biswas et al. 2008; Cheneke, van den Berg and Movileanu 2011; Wang et al. 2012; Pothula and Kleinekathofer 2015). To the best of our knowledge, nothing is known about the regulation of *opdK* (*occK1*) expression.

OpcQ (OccK6)

The *opdQ* (*occK6*) gene has been shown before to be the only porin gene induced by the exposure of *P. aeruginosa* to the oral microflora (Duan et al. 2003). Later on its expression was found to be decreased by exposure to the QS molecules *N*-acyl-homoserine lactones and increased in a *lasR* mutant unable to sense these signal molecules (Schuster et al. 2003; Wagner et al. 2003).

Although its structure has been determined (Fig. S1), not much was known about OpcQ (OccK6) substrate specificity, until a recent interesting publication about its regulation involving the NarXL two-component system (Fowler and Hanson 2015) (Table 1). The same authors found that *opdQ* (*occK6*) is transcriptionally repressed under aerobic conditions while being induced by nitrate, which is dependent on the NarXL two-component system (Fowler and Hanson 2015). Five-prime rapid amplification of cDNA-ends (RACE) experiments allowed to

determine the transcriptional start point of the *opdQ* (*occK6*) gene and putative -10 and -35 promoter sequences were determined as well as two regions forming stem-loop structures with one of them encompassing the -35 element (Fowler and Hanson 2015). Although transcription levels of *opdQ* (*occK6*) were lower in low oxygen conditions (2%), addition of nitrate in the same condition increased the level of transcription and resulted in increased OpdQ (OccK6) protein levels as well (Fowler and Hanson 2015). The NarXL two-component system has been previously determined to be involved in the response of *P. aeruginosa* to nitrate under low oxygen condition (Schreiber et al. 2007; Schobert and Jahn 2010; Trunk et al. 2010; He et al. 2014). Using a *narL* deletion mutant, Fowler and Hanson (2015) observed no change in expression of *opdQ* (*occK6*) by nitrate addition under ambient oxygen condition, but a strong decrease under micro aerobic condition (2% O₂), confirming the involvement of NarL in the regulation of OpdQ (OccK6) production under anaerobic conditions in the presence of nitrate. The same authors suggested that OpdQ (OccK6) might serve as a port of entry for nitrate under low oxygen condition although it has been suggested in previous reports that OpdQ (OccK6) is a porin for carboxylates, including benzoate (Eren et al. 2012; Liu et al. 2012a,b).

OpdT (OccD4)

OpdT (OccD4) is a tyrosine-specific porin (Tamber, Ochs and Hancock 2006). ZnO microparticles have been found to inhibit biofilm formation and the production of the virulence factor pyocyanin and of the signal molecule PQS (Lee et al. 2014) in a concentration that does not affect the planktonic growth. The same authors found that ZnO particles caused a higher expression of 34 genes, including the *czc* operon for Zn efflux system, an effect dependent on the *CzcR* and *RhlR* regulators. The inhibition of biofilm formation by ZnO microparticles was much less pronounced in the *czcR* and *rhlR* single mutants (Lee et al. 2014). Interestingly, the ZnO microparticles caused a decrease in the expression of the *oprD* (*occD1*) porin gene by a factor 8 while increasing the transcription of *opdT* (*occD4*) by a factor 14, results validated by quantitative RT-PCR (Lee et al. 2014). It is interesting to mention that the regulation of *oprD* (*occD1*) and *opdT* (*occD4*) by *CzcR* occurs in opposite directions, i.e. repression for *oprD* (*occD1*) and activation for *opdT* (*occD4*) (Dieppo et al. 2012; Lee et al. 2014) (Fig. 6, Table 1, Fig. S1).

OpdO (OccK3)

OpdO (OccK3) has been described to be involved in the uptake of pyroglutamate (Tamber, Ochs and Hancock 2006). Interestingly, OpdO (OccK3) is the most upregulated porin protein when the AmiE aliphatic amidase is overproduced in *P. aeruginosa*, which results in decreased virulence and reduced production of pyocyanin (Clamens et al. 2017).

INVOLVEMENT OF ECF SIGMA FACTORS IN PORIN GENE EXPRESSION

As already mentioned, several ECF sigma factors are involved in the expression of some porin genes. A comprehensive survey of 10 different *Pseudomonas aeruginosa* PA14 ECF sigma factors global transcriptional network ('sigmulon') has recently been published (Schulz et al. 2015). This study combined different approaches: ChIP-seq, RNA-seq and presence of a

consensus DNA-binding motif (Table 1). After carefully analyzing their data, including in the supplementary file showing the results of a ChIP-seq analysis (the most stringent assay), we found that several porin genes are controlled by one or more ECF σ (Table 1 and Fig. 7). These data revealed that some ECF σ influence the expression of more than one porin gene, *oprG*, *oprF*, *oprD* (*occD1*), *opdC* (*occD2*) and *oprE* (*occK8*) for SigX, *oprH*, *oprF*, *oprP* (and/or *oprO*) and *oprQ* (*occD6*) for RpoS, *oprD* (*occD1*) and *opdC* (*occD2*) for FliA, and *oprD* (*occD1*) and *oprE* (*occK8*) for RpoN. Likewise, some porin genes are controlled by more than one ECF σ . This is the case for *oprH* (RpoS and FecI), *oprF* (AlgU, SigX and RpoS), *oprD* (*occD1*) (SigX, RpoN and FliA), *oprQ* (*occD6*) (SigX and RpoS) and *oprE* (*occK8*) (RpoN, FecI2 and SigX).

PORIN GENES CONSERVATION

A BlastP search (December 2016) for all porin proteins from PAO1 in all *Pseudomonas aeruginosa* complete genomes available in the pseudomonas database (www.pseudomonas.com) (Winsor et al. 2016) revealed a remarkable degree of conservation of these predicted proteins, suggesting that, at least within the *P. aeruginosa* species, the porin genes are part of the core genome. This is in contrast with a previous search for TonB-dependent receptors protein sequences, which revealed that some of them were not shared among the different strains available at the time (Cornelis and Bodilis 2009). There are however some exceptions, which are presented in Table 3. Among the porins present in all 60 *P. aeruginosa* sequenced complete genomes, 10 are fully conserved (*OprF*, *OprG*, *OprH*, *OprE* (OccK8), *OprQ* (OccD6), *OpdC* (OccD2), *OpdB* (OccD7), *OpdF* (OccK2) and *OpdR* (OccK11)). The percentage of amino acid sequence identity for porin orthologs is generally very high, always higher than 90%, with few exceptions (*OpdI* (OccD5), *OpdR* (OccK11) > 80%) in the case of the PA7 isolate, a highly antibiotic-resistant strain isolated in Argentina, which is well known to diverge from all the other *P. aeruginosa* representatives (Roy et al. 2010). The number of amino acids substitutions in PA7 porin proteins is also the highest, confirming its outlier character (Table S1). The number of amino acids substitutions in PA7 porin proteins is also the highest, confirming its outlier character (Table S1, Supporting Information). Not surprisingly, because of its involvement in carbapenem sensitivity, *OprD* (OccD1) is absent in 10 genomes (Table 3). The other frequently lost porins are *OpdG* (OccK9), which is absent from three genomes, *OpdD* (OccK7), also from three genomes, *OpdP* (OccD3) and *OpdT* (OccD4) which are both lost twice. If one excepts the *OprD* (OccD1) situation, there does not seem to be a correlation with the type of isolate and a specific porin gene loss. More intriguing is the loss of both *OprO* and *OprP* phosphate uptake porins in a keratitis strain (Stewart et al. 2011) and of the *OprB* and *OprB2* glucose porins in an ovine mastitis strain although one can argue in this case that it reflects an adaptation to this specific niche (Wright et al. 2015). Interestingly, after 1 year in water, the PAO1 strain has been re-sequenced, and both *OprD* (OccD1) and *OpdP* (OccD3) were lost, suggesting that this strain should be deficient in the uptake of arginine as previously evidenced in the case of a double *oprD* (*occD1*) *opdP* (*occD3*) mutant (Tamber and Hancock 2006). Some porin genes are present in two copies: this is the case for *opdD* (*occK7*) in the VRFPA04 keratitis strain (Table 3) and, intriguingly, for *oprF*, in the two PA1 and PA1R strains, where the entire *ppsA-estX-menG-cmaX-cfrX-cmpX-sigX-oprF* locus is duplicated.

Table 3. Porin protein sequences undetected in different *P. aeruginosa* genomes after a BlastP search on 60 complete genomes.

Genome	Origin	Absent porins		Phenotype/project	Reference
19BR	Human Brazil	OprD (OccD1)	<u>OpdG (OccK9)</u>	Polymyxin R	Boyle et al. (2012)
213BR	Human Brazil	OprD (OccD1)	<u>OpdG (OccK9)</u>	Polymyxin R	Boyle et al. (2012)
S86968	Cancer		<u>OpdG (OccK9)</u>	PRJNA253624	
39016	Keratitis	OprP	OprO	<u>OpdD (OccK7)</u>	Stewart et al. (2011)
B136-33	Human diarrhea	OpdK (OccK1)			
DK2	CF Denmark	OpdL (OccK4)	OpdN (OccK10)		Yang, Jelsbak and Molin (2011)
NGCM2S1	MDR Japan	OprD (OccD1)		<u>OpdD (OccK7)</u>	Miyoshi-Akiyama et al. (2011)
PA7	MDR Argentina			<u>OpdD (OccK7)</u>	Roy et al. (2010)
PA96	M18 clone MDR	OpdO (OccK3)			Xiong et al. (2013)
PAO1H2O	PAO1-water	OprD (OccD1)	OpdP (OccD3)	PRJNA83447	
T63266	Cancer		OpdP (OccD3)	PRJNA253624	
RP73	CF Canada	OprD (OccD1)		OpdT (OccD4)	Jeukens et al. (2013)
F30658	Cancer	OprD (OccD1)		OpdT (OccD4)	PRJNA253624
F22031	Cancer	OprD (OccD1)		PRJNA253624	
F23197	Cancer	OprD (OccD1)		PRJNA253624	
F9670	Cancer	OpdQ (OccK6)			
FRD1	CF mucoid	OpdI (OccD5)	OpdJ (OccD8)		Lindsey et al. (2008)
PSE305	Ovine mastitis	OprB			Wright et al. (2015)
W36662	Cancer	OprD (OccD1)		PRJNA253624	
VRFPA04	Keratitis India	OprD (OccD1)	OpdH (OccK5)		Murugan et al. (2016)

The porins absent in more than one genome are shaded in different tones of gray: OprD 10 genomes (dark gray and bold), OpdG and OpdD three genomes (gray and underlined), OpdP and OpdT two genomes (light gray).

CONCLUSIONS

From this last literature survey, it is apparent that a large amount of information has become available on the *Pseudomonas aeruginosa* porins, including some structure/function analysis, and data on their regulation. It shows that the major OprF porin is strongly involved in envelope integrity via interactions with peptidoglycan and other outer membrane proteins, including OprL and OprI. It also demonstrates the implication of OprF, and more recently OprH, in other functions, including adhesion and recognition of external cues from the host. One other important message is the complex regulation of the expression of porin genes (when known) although much more data need certainly to be obtained to get a better insight into their dynamic regulation which reflect their involvement in the high adaptability of *P. aeruginosa* to changing environmental conditions. Although this review did not attempt to explore the conservation of porin genes within the entire *Pseudomonas* genus, their high degree of conservation within the *P. aeruginosa* species is striking. It is our hope that this review will stimulate more research on these fascinating outer membrane proteins, their function and regulation, not only in *P. aeruginosa*, but also in other pseudomonads.

SUPPLEMENTARY DATA

Supplementary data are available at [FEMSRE](https://femsre.oup.com/femsre/article/41/5/698/3959603) online.

FUNDING

This work was supported by grants from the Communauté d'Agglomération d'Evreux, the Conseil Général de l'Eure, the European regional development fund (ERDF) and the Normandie Regional Council.

Conflict of interest. None declared.

REFERENCES

- Arhin A, Boucher C. The outer membrane protein OprQ and adherence of *Pseudomonas aeruginosa* to human fibronectin. *Microbiology* 2010;156:1415–23.
- Azghani AO, Idell S, Bains M et al. *Pseudomonas aeruginosa* outer membrane protein F is an adhesin in bacterial binding to lung epithelial cells in culture. *Microb Pathog* 2002;33:109–14.
- Babin BM, Bergkessel M, Sweredoski MJ et al. SutA is a bacterial transcription factor expressed during slow growth in *Pseudomonas aeruginosa*. *P Natl Acad Sci USA* 2016;113:E597–605.
- Balasubramanian D, Kumari H, Jaric M et al. Deep sequencing analyses expands the *Pseudomonas aeruginosa* AmpR regulon to include small RNA-mediated regulation of iron acquisition, heat shock and oxidative stress response. *Nucleic Acids Res* 2014;42:979–98.
- Balasubramanian D, Kumari H, Mathee K. *Pseudomonas aeruginosa* AmpR: an acute-chronic switch regulator. *Pathog Dis* 2015;73:1–14.
- Balasubramanian D, Schneper L, Merighi M et al. The regulatory repertoire of *Pseudomonas aeruginosa* AmpC ss-lactamase regulator AmpR includes virulence genes. *PLoS One* 2012;7:e34067.
- Bellido F, Martin NL, Siehnel RJ et al. Reevaluation, using intact cells, of the exclusion limit and role of porin OprF in *Pseudomonas aeruginosa* outer membrane permeability. *J Bacteriol* 1992;174:5196–203.
- Benz R, Jones MD, Younas F et al. OmpW of *Caulobacter crescentus* Functions as an outer membrane channel for cations. *PLoS One* 2015;10:e0143557.
- Bielecki P, Jensen V, Schulze W et al. Cross talk between the response regulators PhoB and TctD allows for the integration of diverse environmental signals in *Pseudomonas aeruginosa*. *Nucleic Acids Res* 2015;43:6413–25.
- Biswas S, Mohammad MM, Movileanu L et al. Crystal structure of the outer membrane protein OpdK from *Pseudomonas aeruginosa*. *Structure* 2008;16:1027–35.

- Biswas S, Mohammad MM, Patel DR et al. Structural insight into OprD substrate specificity. *Nat Struct Mol Biol* 2007;**14**:1108–9.
- Blanka A, Schulz S, Eckweiler D et al. Identification of the alternative sigma factor SigX regulon and its implications for *Pseudomonas aeruginosa* pathogenicity. *J Bacteriol* 2014;**196**:345–56.
- Bodilis J, Calbrix R, Guerillon J et al. Phylogenetic relationships between environmental and clinical isolates of *Pseudomonas fluorescens* and related species deduced from 16S rRNA gene and OprF protein sequences. *Syst Appl Microbiol* 2004;**27**:93–108.
- Boechar AL, Kaihami GH, Politi MJ et al. A novel role for an ECF sigma factor in fatty acid biosynthesis and membrane fluidity in *Pseudomonas aeruginosa*. *PLoS One* 2013;**8**:e84775.
- Bossi L, Figueroa-Bossi N. A small RNA downregulates LamB maltoporin in *Salmonella*. *Mol Microbiol* 2007;**65**:799–810.
- Boucher JC, Yu H, Mudd MH et al. Mucoid *Pseudomonas aeruginosa* in cystic fibrosis: characterization of muc mutations in clinical isolates and analysis of clearance in a mouse model of respiratory infection. *Infect Immun* 1997;**65**:3838–46.
- Bouffartigues E, Duchesne R, Bazire A et al. Sucrose favors *Pseudomonas aeruginosa* pellicle production through the extracytoplasmic function sigma factor SigX. *FEMS Microbiol Lett* 2014;**356**:193–200.
- Bouffartigues E, Gicquel G, Bazire A et al. Transcription of the oprF gene of *Pseudomonas aeruginosa* is dependent mainly on the SigX sigma factor and is sucrose induced. *J Bacteriol* 2012;**194**:4301–11.
- Bouffartigues E, Moscoso JA, Duchesne R et al. The absence of the *Pseudomonas aeruginosa* OprF protein leads to increased biofilm formation through variation in c-di-GMP level. *Front Microbiol* 2015;**6**:630.
- Boyle B, Fernandez L, Laroche J et al. Complete genome sequences of three *Pseudomonas aeruginosa* isolates with phenotypes of polymyxin B adaptation and inducible resistance. *J Bacteriol* 2012;**194**:529–30.
- Brinkman FS, Bains M, Hancock RE. The amino terminus of *Pseudomonas aeruginosa* outer membrane protein OprF forms channels in lipid bilayer membranes: correlation with a three-dimensional model. *J Bacteriol* 2000;**182**:5251–5.
- Brinkman FS, Schoofs G, Hancock RE et al. Influence of a putative ECF sigma factor on expression of the major outer membrane protein, OprF, in *Pseudomonas aeruginosa* and *Pseudomonas fluorescens*. *J Bacteriol* 1999;**181**:4746–54.
- Caille O, Rossier C, Perron K. A copper-activated two-component system interacts with zinc and imipenem resistance in *Pseudomonas aeruginosa*. *J Bacteriol* 2007;**189**:4561–8.
- Cascales E, Bernadac A, Gavioli M et al. Pal lipoprotein of *Escherichia coli* plays a major role in outer membrane integrity. *J Bacteriol* 2002;**184**:754–9.
- Cascales E, Lloubes R. Deletion analyses of the peptidoglycan-associated lipoprotein Pal reveals three independent binding sequences including a TolA box. *Mol Microbiol* 2004;**51**:873–85.
- Catel-Ferreira M, Marti S, Guillon L et al. The outer membrane porin OmpW of *Acinetobacter baumannii* is involved in iron uptake and colistin binding. *FEBS Lett* 2016;**590**:224–31.
- Chambers JR, Liao J, Schurr MJ et al. BrlR from *Pseudomonas aeruginosa* is a c-di-GMP-responsive transcription factor. *Mol Microbiol* 2014;**92**:471–87.
- Chambers JR, Sauer K. The MerR-like regulator BrlR impairs *Pseudomonas aeruginosa* biofilm tolerance to colistin by repressing PhoPQ. *J Bacteriol* 2013;**195**:4678–88.
- Cheneke BR, van den Berg B, Movileanu L. Analysis of gating transitions among the three major open states of the OpdK channel. *Biochemistry* 2011;**50**:4987–97.
- Choi DS, Kim DK, Choi SJ et al. Proteomic analysis of outer membrane vesicles derived from *Pseudomonas aeruginosa*. *Proteomics* 2011;**11**:3424–9.
- Chou HT, Kwon DH, Hegazy M et al. Transcriptome analysis of agmatine and putrescine catabolism in *Pseudomonas aeruginosa* PAO1. *J Bacteriol* 2008;**190**:1966–75.
- Chua SL, Liu Y, Yam JK et al. Dispersed cells represent a distinct stage in the transition from bacterial biofilm to planktonic lifestyles. *Nat Commun* 2014;**5**:4462.
- Chugani S, Greenberg EP. The influence of human respiratory epithelia on *Pseudomonas aeruginosa* gene expression. *Microb Pathog* 2007;**42**:29–35.
- Clamens T, Rosay T, Crepin A et al. The aliphatic amidase AmiE is involved in regulation of *Pseudomonas aeruginosa* virulence. *Sci Rep* 2017;**7**:41178.
- Confer AW, Ayalew S. The OmpA family of proteins: roles in bacterial pathogenesis and immunity. *Vet Microbiol* 2013;**163**:207–22.
- Cornelis P, Bodilis J. A survey of TonB-dependent receptors in fluorescent pseudomonads. *Environ Microbiol Rep* 2009;**1**:256–62.
- Cornelis P, Bouia A, Belarbi A et al. Cloning and analysis of the gene for the major outer membrane lipoprotein from *Pseudomonas aeruginosa*. *Mol Microbiol* 1989;**3**:421–8.
- Cornelis P, Matthijs S, Van Oeffelen L. Iron uptake regulation in *Pseudomonas aeruginosa*. *Biomaterials* 2009;**22**:15–22.
- Couto N, Schooling SR, Dutcher JR et al. Proteome profiles of outer membrane vesicles and extracellular matrix of *Pseudomonas aeruginosa* biofilms. *J Proteome Res* 2015;**14**:4207–22.
- Crespo MC, Valverde C. A single mutation in the oprF mRNA leader confers strict translational control by the Gac/Rsm system in *Pseudomonas fluorescens* CHA0. *Curr Microbiol* 2009;**58**:182–8.
- Daddaoua A, Molina-Santiago C, de la Torre J et al. GtrS and GltR form a two-component system: the central role of 2-ketogluconate in the expression of exotoxin A and glucose catabolic enzymes in *Pseudomonas aeruginosa*. *Nucleic Acids Res* 2014;**42**:7654–63.
- Danoff EJ, Fleming KG. Aqueous, Unfolded OmpA forms amyloid-like fibrils upon self-association. *PLoS One* 2015;**10**:e0132301.
- Deng X, Liang H, Ulanovskaya OA et al. Steady-state hydrogen peroxide induces glycolysis in *Staphylococcus aureus* and *Pseudomonas aeruginosa*. *J Bacteriol* 2014;**196**:2499–513.
- Diepolder G, Ducret V, Caille O et al. The transcriptional regulator CzcR modulates antibiotic resistance and quorum sensing in *Pseudomonas aeruginosa*. *PLoS One* 2012;**7**:e38148.
- Diggle SP, Matthijs S, Wright VJ et al. The *Pseudomonas aeruginosa* 4-quinolone signal molecules HHQ and PQS play multifunctional roles in quorum sensing and iron entrapment. *Chem Biol* 2007;**14**:87–96.
- Dosunmu EF, Chaudhari AA, Bawage S et al. Novel cationic peptide TP359 down-regulates the expression of outer membrane biogenesis genes in *Pseudomonas aeruginosa*: a potential TP359 anti-microbial mechanism. *BMC Microbiol* 2016;**16**:192.
- Dötsch A, Eckweiler D, Schniederjans M et al. The *Pseudomonas aeruginosa* transcriptome in planktonic cultures and static biofilms using RNA sequencing. *PLoS One* 2012;**7**:e31092.
- Duan K, Dammel C, Stein J et al. Modulation of *Pseudomonas aeruginosa* gene expression by host microflora through interspecies communication. *Mol Microbiol* 2003;**50**:1477–91.

- Dubern JF, Diggle SP. Quorum sensing by 2-alkyl-4-quinolones in *Pseudomonas aeruginosa* and other bacterial species. *Mol Biosyst* 2008;**4**:882–8.
- Duchene M, Schweizer A, Lottspeich F et al. Sequence and transcriptional start site of the *Pseudomonas aeruginosa* outer membrane porin protein F gene. *J Bacteriol* 1988;**170**:155–62.
- Duchesne R, Bouffartigues E, Oxaran V et al. A proteomic approach of SigX function in *Pseudomonas aeruginosa* outer membrane composition. *J Proteomics* 2013;**94**:451–9.
- Ducret V, Gonzalez MR, Scignari T et al. OprD repression upon metal treatment requires the RNA chaperone Hfq in *Pseudomonas aeruginosa*. *Genes (Basel)* 2016;**7**:82; DOI: 10.3390/genes7100082.
- Edrington TC, Kintz E, Goldberg JB et al. Structural basis for the interaction of lipopolysaccharide with outer membrane protein H (OprH) from *Pseudomonas aeruginosa*. *J Biol Chem* 2011;**286**:39211–23.
- Eichner A, Gunther N, Arnold M et al. Marker genes for the metabolic adaptation of *Pseudomonas aeruginosa* to the hypoxic cystic fibrosis lung environment. *Int J Med Microbiol* 2014;**304**:1050–61.
- Eren E, Parkin J, Adelanwa A et al. Toward understanding the outer membrane uptake of small molecules by *Pseudomonas aeruginosa*. *J Biol Chem* 2013;**288**:12042–53.
- Eren E, Vijayaraghavan J, Liu J et al. Substrate specificity within a family of outer membrane carboxylate channels. *PLoS Biol* 2012;**10**:e1001242.
- Fernandez L, Hancock RE. Adaptive and mutational resistance: role of porins and efflux pumps in drug resistance. *Clin Microbiol Rev* 2012;**25**:661–81.
- Firoved AM, Boucher JC, Deretic V. Global genomic analysis of AlgU (sigma(E))-dependent promoters (sigmulon) in *Pseudomonas aeruginosa* and implications for inflammatory processes in cystic fibrosis. *J Bacteriol* 2002;**184**:1057–64.
- Fito-Boncompote L, Chapalain A, Bouffartigues E et al. Full virulence of *Pseudomonas aeruginosa* requires OprF. *Infect Immun* 2011;**79**:1176–86.
- Folkesson A, Jelsbak L, Yang L et al. Adaptation of *Pseudomonas aeruginosa* to the cystic fibrosis airway: an evolutionary perspective. *Nat Rev Microbiol* 2012;**10**:841–51.
- Fowler RC, Hanson ND. The OpdQ porin of *Pseudomonas aeruginosa* is regulated by environmental signals associated with cystic fibrosis including nitrate-induced regulation involving the NarXL two-component system. *Microbiologyopen* 2015;**4**:967–82.
- Fung C, Naughton S, Turnbull L et al. Gene expression of *Pseudomonas aeruginosa* in a mucin-containing synthetic growth medium mimicking cystic fibrosis lung sputum. *J Med Microbiol* 2010;**59**:1089–100.
- Funken H, Bartels KM, Wilhelm S et al. Specific association of lectin LecB with the surface of *Pseudomonas aeruginosa*: role of outer membrane protein OprF. *PLoS One* 2012;**7**:e46857.
- Gellatly SL, Needham B, Madera L et al. The *Pseudomonas aeruginosa* PhoP-PhoQ two-component regulatory system is induced upon interaction with epithelial cells and controls cytotoxicity and inflammation. *Infect Immun* 2012;**80**:3122–31.
- Gensberg K, Smith AW, Brinkman FS et al. Identification of oprG, a gene encoding a major outer membrane protein of *Pseudomonas aeruginosa*. *J Antimicrob Chemoth* 1999;**43**:607–8.
- Ghysels B, Dieu BT, Beatson SA et al. FpvB, an alternative type I ferripyoverdine receptor of *Pseudomonas aeruginosa*. *Microbiology* 2004;**150**:1671–80.
- Ghysels B, Ochsner U, Mollman U et al. The *Pseudomonas aeruginosa* pirA gene encodes a second receptor for ferrienterobactin and synthetic catecholate analogues. *FEMS Microbiol Lett* 2005;**246**:167–74.
- Gicquel G, Bouffartigues E, Bains M et al. The extra-cytoplasmic function sigma factor SigX modulates biofilm and virulence-related properties in *Pseudomonas aeruginosa*. *PLoS One* 2013;**8**:e80407.
- Goldberg JB. *Pseudomonas*: global bacteria. *Trends Microbiol* 2000;**8**:55–7.
- Gomez-Lozano M, Marvig RL, Molin S et al. Genome-wide identification of novel small RNAs in *Pseudomonas aeruginosa*. *Environ Microbiol* 2012;**14**:2006–16.
- Gotoh N, Wakebe H, Yoshihara E et al. Role of protein F in maintaining structural integrity of the *Pseudomonas aeruginosa* outer membrane. *J Bacteriol* 1989;**171**:983–90.
- Guragain M, King MM, Williamson KS et al. The *Pseudomonas aeruginosa* PAO1 two-component regulator CarSR regulates calcium homeostasis and calcium-induced virulence factor production through its regulatory targets CarO and CarP. *J Bacteriol* 2016;**198**:951–63.
- Hammond JH, Dolben EF, Smith TJ et al. Links between Anr and quorum sensing in *Pseudomonas aeruginosa* biofilms. *J Bacteriol* 2015;**197**:2810–20.
- Hancock RE. Resistance mechanisms in *Pseudomonas aeruginosa* and other nonfermentative gram-negative bacteria. *Clin Infect Dis* 1998;**27** Suppl 1:S93–9.
- Hancock RE, Brinkman FS. Function of *Pseudomonas* porins in uptake and efflux. *Annu Rev Microbiol* 2002;**56**:17–38.
- Hancock RE, Carey AM. Outer membrane of *Pseudomonas aeruginosa*: heat-2-mercaptoethanol-modifiable proteins. *J Bacteriol* 1979;**140**:902–10.
- Hancock RE, Decad GM, Nikaido H. Identification of the protein producing transmembrane diffusion pores in the outer membrane of *Pseudomonas aeruginosa* PAO1. *Biochim Biophys Acta* 1979;**554**:323–31.
- Hancock RE, Egli C, Benz R et al. Overexpression in *Escherichia coli* and functional analysis of a novel PPI-selective porin, OprO, from *Pseudomonas aeruginosa*. *J Bacteriol* 1992;**174**:471–6.
- Hari-Dass R, Shah C, Meyer DJ et al. Serum amyloid A protein binds to outer membrane protein A of gram-negative bacteria. *J Biol Chem* 2005;**280**:18562–7.
- Hassett DJ, Cuppoletti J, Trapnell B et al. Anaerobic metabolism and quorum sensing by *Pseudomonas aeruginosa* biofilms in chronically infected cystic fibrosis airways: rethinking antibiotic treatment strategies and drug targets. *Adv Drug Deliv Rev* 2002;**54**:1425–43.
- He FQ, Wang W, Zheng P et al. Essential O₂-responsive genes of *Pseudomonas aeruginosa* and their network revealed by integrating dynamic data from inverted conditions. *Integr Biol (Camb)* 2014;**6**:215–23.
- Hemamalini R, Khare S. A proteomic approach to understand the role of the outer membrane porins in the organic solvent-tolerance of *Pseudomonas aeruginosa* PseA. *PLoS One* 2014;**9**:e103788.
- Henderson JC, Zimmerman SM, Crofts AA et al. The power of asymmetry: architecture and assembly of the Gram-negative outer membrane lipid bilayer. *Annu Rev Microbiol* 2016;**70**:255–78.
- Hogardt M, Heesemann J. Adaptation of *Pseudomonas aeruginosa* during persistence in the cystic fibrosis lung. *Int J Med Microbiol* 2010;**300**:557–62.
- Hong H, Patel DR, Tamm LK et al. The outer membrane protein OmpW forms an eight-stranded beta-barrel with a hydrophobic channel. *J Biol Chem* 2006;**281**:7568–77.

- Huang H, Hancock RE. Genetic definition of the substrate selectivity of outer membrane porin protein OprD of *Pseudomonas aeruginosa*. *J Bacteriol* 1993;175:7793–800.
- Huang H, Hancock RE. The role of specific surface loop regions in determining the function of the imipenem-specific pore protein OprD of *Pseudomonas aeruginosa*. *J Bacteriol* 1996;178:3085–90.
- Jaouen T, Coquet L, Marvin-Guy L et al. Functional characterization of *Pseudomonas fluorescens* OprE and OprQ membrane proteins. *Biochem Biophys Res Commun* 2006;346:1048–52.
- Jaouen T, De E, Chevalier S et al. Pore size dependence on growth temperature is a common characteristic of the major outer membrane protein OprF in psychrotrophic and mesophilic *Pseudomonas* species. *Appl Environ Microb* 2004;70:6665–9.
- Jeukens J, Boyle B, Bianconi I et al. Complete genome sequence of persistent cystic fibrosis isolate *Pseudomonas aeruginosa* strain RP73. *Genome Announc* 2013;1, DOI: 10.1128/genomeA.00568-13.
- Johansen J, Rasmussen AA, Overgaard M et al. Conserved small non-coding RNAs that belong to the sigmaE regulon: role in down-regulation of outer membrane proteins. *J Mol Biol* 2006;364:1–8.
- Joiner KA, Fries LF, Frank MM. Studies of antibody and complement function in host defense against bacterial infection. *Immunol Lett* 1987;14:197–202.
- Journet L, Rigal A, Lazdunski C et al. Role of TolR N-terminal, central, and C-terminal domains in dimerization and interaction with TolA and tolQ. *J Bacteriol* 1999;181:4476–84.
- Khatua B, Van Vleet J, Choudhury BP et al. Sialylation of outer membrane porin protein D: a mechanistic basis of antibiotic uptake in *Pseudomonas aeruginosa*. *Mol Cell Proteomics* 2014;13:1412–28.
- Kim JH, Lee J, Park J et al. Gram-negative and Gram-positive bacterial extracellular vesicles. *Semin Cell Dev Biol* 2015;40:97–104.
- Kingston AW, Subramanian C, Rock CO et al. A sigmaW-dependent stress response in *Bacillus subtilis* that reduces membrane fluidity. *Mol Microbiol* 2011;81:69–79.
- Kohler T, Epp SF, Curty LK et al. Characterization of MexT, the regulator of the MexE-MexF-OprN multidrug efflux system of *Pseudomonas aeruginosa*. *J Bacteriol* 1999a;181:6300–5.
- Kohler T, Michea-Hamzehpour M, Epp SF et al. Carbapenem activities against *Pseudomonas aeruginosa*: respective contributions of OprD and efflux systems. *Antimicrob Agents Ch* 1999b;43:424–7.
- Kos VN, McLaughlin RE, Gardner HA. Identification of unique in-frame deletions in OprD among clinical isolates of *Pseudomonas aeruginosa*. *Pathog Dis* 2016;74.
- Kreamer NN, Costa F, Newman DK. The ferrous iron-responsive BqsRS two-component system activates genes that promote cationic stress tolerance. *MBio* 2015;6:e02549.
- Kreamer NN, Wilks JC, Marlow JJ et al. BqsR/BqsS constitute a two-component system that senses extracellular Fe(II) in *Pseudomonas aeruginosa*. *J Bacteriol* 2012;194:1195–204.
- Krishnan S, Prasadarao NV. Outer membrane protein A and OprF: versatile roles in Gram-negative bacterial infections. *FEBS J* 2012;279:919–31.
- Kruczek C, Kottapalli KR, Dissanaik S et al. Major transcriptome changes accompany the growth of *Pseudomonas aeruginosa* in blood from patients with severe thermal injuries. *PLoS One* 2016;11:e0149229.
- Kucharska I, Liang B, Ursini N et al. Molecular interactions of lipopolysaccharide with an outer membrane protein from *Pseudomonas aeruginosa* probed by solution NMR. *Biochemistry* 2016;55:5061–72.
- Kucharska I, Seelheim P, Edrington T et al. OprG harnesses the dynamics of its extracellular loops to transport small amino acids across the outer membrane of *Pseudomonas aeruginosa*. *Structure* 2015;23:2234–45.
- Kulp A, Kuehn MJ. Biological functions and biogenesis of secreted bacterial outer membrane vesicles. *Annu Rev Microbiol* 2010;64:163–84.
- Kwon DH, Lu CD. Polyamines induce resistance to cationic peptide, aminoglycoside, and quinolone antibiotics in *Pseudomonas aeruginosa* PAO1. *Antimicrob Agents Ch* 2006;50:1615–22.
- Lee J, Wu J, Deng Y et al. A cell-cell communication signal integrates quorum sensing and stress response. *Nat Chem Biol* 2013;9:339–43.
- Lee JH, Kim YG, Cho MH et al. ZnO nanoparticles inhibit *Pseudomonas aeruginosa* biofilm formation and virulence factor production. *Microbiol Res* 2014;169:888–96.
- Lewenza S, Gardy JL, Brinkman FS et al. Genome-wide identification of *Pseudomonas aeruginosa* exported proteins using a consensus computational strategy combined with a laboratory-based PhoA fusion screen. *Genome Res* 2005;15:321–9.
- Li L, Komatsu T, Inoue A et al. A toluene-tolerant mutant of *Pseudomonas aeruginosa* lacking the outer membrane protein F. *Biosci Biotech Biochem* 1995;59:2358–9.
- Liao J, Sauer K. The MerR-like transcriptional regulator BrIR contributes to *Pseudomonas aeruginosa* biofilm tolerance. *J Bacteriol* 2012;194:4823–36.
- Liao J, Schurr MJ, Sauer K. The MerR-like regulator BrIR confers biofilm tolerance by activating multidrug efflux pumps in *Pseudomonas aeruginosa* biofilms. *J Bacteriol* 2013;195:3352–63.
- Lim A Jr, De Vos D, Brauns M et al. Molecular and immunological characterization of OprL, the 18 kDa outer-membrane peptidoglycan-associated lipoprotein (PAL) of *Pseudomonas aeruginosa*. *Microbiology* 1997;143:1709–16.
- Lindsey TL, Hagins JM, Sokol PA et al. Virulence determinants from a cystic fibrosis isolate of *Pseudomonas aeruginosa* include isocitrate lyase. *Microbiology* 2008;154:1616–27.
- Liu J, Eren E, Vijayaraghavan J et al. OccK channels from *Pseudomonas aeruginosa* exhibit diverse single-channel electrical signatures but conserved anion selectivity. *Biochemistry* 2012a;51:2319–30.
- Liu J, Wolfe AJ, Eren E et al. Cation selectivity is a conserved feature in the OccD subfamily of *Pseudomonas aeruginosa*. *Biochim Biophys Acta* 2012b;1818:2908–16.
- Llamas MA, Imperi F, Visca P et al. Cell-surface signaling in *Pseudomonas*: stress responses, iron transport, and pathogenicity. *FEMS Microbiol Rev* 2014;38:569–97.
- Lundell DL, Narula SK. Structural elements required for receptor recognition of human interferon-gamma. *Pharmacol Ther* 1994;64:1–21.
- Lyczak JB, Cannon CL, Pier GB. Establishment of *Pseudomonas aeruginosa* infection: lessons from a versatile opportunist. *Microbes Infect/Institut Pasteur* 2000;2:1051–60.
- Macfarlane EL, Kwasnicka A, Hancock RE. Role of *Pseudomonas aeruginosa* PhoP-phoQ in resistance to antimicrobial cationic peptides and aminoglycosides. *Microbiology* 2000;146:2543–54.
- Macfarlane EL, Kwasnicka A, Ochs MM et al. PhoP-PhoQ homologues in *Pseudomonas aeruginosa* regulate expression of the outer-membrane protein OprH and polymyxin B resistance. *Mol Microbiol* 1999;34:305–16.

- McPhee JB, Bains M, Winsor G et al. Contribution of the PhoP-PhoQ and PmrA-PmrB two-component regulatory systems to Mg²⁺-induced gene regulation in *Pseudomonas aeruginosa*. *J Bacteriol* 2006;**188**:3995–4006.
- McPhee JB, Tamber S, Bains M et al. The major outer membrane protein OprG of *Pseudomonas aeruginosa* contributes to cytotoxicity and forms an anaerobically regulated, cation-selective channel. *FEMS Microbiol Lett* 2009;**296**:241–7.
- Malhotra S, Silo-Suh LA, Mathee K et al. Proteome analysis of the effect of mucoid conversion on global protein expression in *Pseudomonas aeruginosa* strain PAO1 shows induction of the disulfide bond isomerase, *dsbA*. *J Bacteriol* 2000;**182**:6999–7006.
- Manning AJ, Kuehn MJ. Contribution of bacterial outer membrane vesicles to innate bacterial defense. *BMC Microbiol* 2011;**11**:258.
- Mao F, Dam P, Chou J et al. DOOR: a database for prokaryotic operons. *Nucleic Acids Res* 2009;**37**:D459–63.
- Maredia R, Devineni N, Lentz P et al. Vesiculation from *Pseudomonas aeruginosa* under SOS. *ScientificWorldJournal* 2012;**2012**:402919.
- Maura D, Hazan R, Kitao T et al. Evidence for direct control of virulence and defense gene circuits by the *Pseudomonas aeruginosa* quorum sensing regulator, MvfR. *Sci Rep* 2016;**6**:34083.
- Meyer JM. Exogenous siderophore-mediated iron uptake in *Pseudomonas aeruginosa*: possible involvement of porin OprF in iron translocation. *J Gen Microbiol* 1992;**138**:951–8.
- Mishra M, Ressler A, Schlesinger LS et al. Identification of OprF as a complement component C3 binding acceptor molecule on the surface of *Pseudomonas aeruginosa*. *Infect Immun* 2015;**83**:3006–14.
- Mittal R, Grati M, Gerring R et al. In vitro interaction of *Pseudomonas aeruginosa* with human middle ear epithelial cells. *PLoS One* 2014;**9**:e91885.
- Mittal R, Grati M, Yan D et al. *Pseudomonas aeruginosa* activates PKC- α to invade middle ear epithelial cells. *Front Microbiol* 2016;**7**:255.
- Miyoshi-Akiyama T, Kuwahara T, Tada T et al. Complete genome sequence of highly multidrug-resistant *Pseudomonas aeruginosa* NCGM2.S1, a representative strain of a cluster endemic to Japan. *J Bacteriol* 2011;**193**:7010.
- Modi N, Barcena-Uribarri I, Bains M et al. Tuning the affinity of anion binding sites in porin channels with negatively charged residues: molecular details for OprP. *ACS Chem Biol* 2015;**10**:441–51.
- Moraes TF, Bains M, Hancock RE et al. An arginine ladder in OprP mediates phosphate-specific transfer across the outer membrane. *Nat Struct Mol Biol* 2007;**14**:85–7.
- Murugan N, Malathi J, Umashankar V et al. Unraveling genomic and phenotypic nature of multidrug-resistant (MDR) *Pseudomonas aeruginosa* VRPA04 isolated from keratitis patient. *Microbiol Res* 2016;**193**:140–9.
- Nakae T. Identification of the outer membrane protein of *E. coli* that produces transmembrane channels in reconstituted vesicle membranes. *Biochem Biophys Res Commun* 1976;**71**:877–84.
- Navare AT, Chavez JD, Zheng C et al. Probing the protein interaction network of *Pseudomonas aeruginosa* cells by chemical cross-linking mass spectrometry. *Structure* 2015;**23**:762–73.
- Nestorovich EM, Sugawara E, Nikaido H et al. *Pseudomonas aeruginosa* porin OprF: properties of the channel. *J Biol Chem* 2006;**281**:16230–7.
- Nikaido H. Molecular basis of bacterial outer membrane permeability revisited. *Microbiol Mol Biol Rev* 2003;**67**:593–656.
- O'Callaghan J, Reen FJ, Adams C et al. A novel host-responsive sensor mediates virulence and type III secretion during *Pseudomonas aeruginosa*-host cell interactions. *Microbiology* 2012;**158**:1057–70.
- Ochs MM, McCusker MP, Bains M et al. Negative regulation of the *Pseudomonas aeruginosa* outer membrane porin OprD selective for imipenem and basic amino acids. *Antimicrob Agents Chem* 1999a;**43**:1085–90.
- Ochs MM, Lu CD, Hancock RE et al. Amino acid-mediated induction of the basic amino acid-specific outer membrane porin OprD from *Pseudomonas aeruginosa*. *J Bacteriol* 1999b;**181**:5426–32.
- Okamoto K, Gotoh N, Tsujimoto H et al. Molecular cloning and characterization of the *oprQ* gene coding for outer membrane protein OprE3 of *Pseudomonas aeruginosa*. *Microbiol Immunol* 1999;**43**:297–301.
- Olaitan AO, Morand S, Rolain JM. Mechanisms of polymyxin resistance: acquired and intrinsic resistance in bacteria. *Front Microbiol* 2014;**5**:643.
- Orench-Rivera N, Kuehn MJ. Environmentally controlled bacterial vesicle-mediated export. *Cell Microbiol* 2016;**18**:1525–36.
- Papenfort K, Bassler BL. Quorum sensing signal-response systems in Gram-negative bacteria. *Nat Rev Microbiol* 2016;**14**:576–88.
- Park AJ, Murphy K, Surette MD et al. Tracking the dynamic relationship between cellular systems and extracellular sub-proteomes in *Pseudomonas aeruginosa* biofilms. *J Proteome Res* 2015;**14**:4524–37.
- Pathirana RD, Kaparakis-Liaskos M. Bacterial membrane vesicles: biogenesis, immune regulation and pathogenesis. *Cell Microbiol* 2016;**18**:1518–24.
- Perez FJ, Gimeno C, Navarro D et al. Meropenem permeation through the outer membrane of *Pseudomonas aeruginosa* can involve pathways other than the OprD porin channel. *Chemotherapy* 1996;**42**:210–4.
- Pirnay JP, De Vos D, Mossialos D et al. Analysis of the *Pseudomonas aeruginosa oprD* gene from clinical and environmental isolates. *Environ Microbiol* 2002;**4**:872–82.
- Pongprayoon P, Beckstein O, Wee CL et al. Simulations of anion transport through OprP reveal the molecular basis for high affinity and selectivity for phosphate. *Proc Natl Acad Sci USA* 2009;**106**:21614–8.
- Pothula KR, Kleinekathofer U. Theoretical analysis of ion conductance and gating transitions in the OprK (OckK1) channel. *Analyst* 2015;**140**:4855–64.
- Potvin E, Sanschagrin F, Levesque RC. Sigma factors in *Pseudomonas aeruginosa*. *FEMS Microbiol Rev* 2008;**32**:38–55.
- Pratt LA, Hsing W, Gibson KE et al. From acids to *osmZ*: multiple factors influence synthesis of the OmpF and OmpC porins in *Escherichia coli*. *Mol Microbiol* 1996;**20**:911–7.
- Pusic P, Tata M, Wolfinger MT et al. Cross-regulation by CrcZ RNA controls anoxic biofilm formation in *Pseudomonas aeruginosa*. *Sci Rep* 2016;**6**:39621.
- Qadi M, Lopez-Causape C, Izquierdo-Rabassa S et al. Surfactant protein A recognizes outer membrane protein OprH on *Pseudomonas aeruginosa* isolates from individuals with chronic infection. *J Infect Dis* 2016;**214**:1449–55.
- Quigley KJ, Reynolds CJ, Goudet A et al. Chronic infection by mucoid *Pseudomonas aeruginosa* associated with dysregulation in T-Cell immunity to outer membrane porin F. *Am J Respir Crit Care* 2015;**191**:1250–64.
- Quinn JP, Darzins A, Miyashiro D et al. Imipenem resistance in *Pseudomonas aeruginosa* PAO: mapping of the OprD2 gene. *Antimicrob Agents Chem* 1991;**35**:753–5.

- Rawling EG, Brinkman FS, Hancock RE. Roles of the carboxy-terminal half of *Pseudomonas aeruginosa* major outer membrane protein OprF in cell shape, growth in low-osmolarity medium, and peptidoglycan association. *J Bacteriol* 1998;**180**:3556–62.
- Remans K, Vercammen K, Bodilis J et al. Genome-wide analysis and literature-based survey of lipoproteins in *Pseudomonas aeruginosa*. *Microbiology* 2010;**156**:2597–607.
- Reusch RN. Biogenesis and functions of model integral outer membrane proteins: *Escherichia coli* OmpA and *Pseudomonas aeruginosa* OprF. *FEBS J* 2012;**279**:893.
- Richardot C, Plesiat P, Fournier D et al. Carbapenem resistance in cystic fibrosis strains of *Pseudomonas aeruginosa* as a result of amino acid substitutions in porin OprD. *Int J Antimicrob Ag* 2015;**45**:529–32.
- Rodrigue A, Quentin Y, Lazdunski A et al. Two-component systems in *Pseudomonas aeruginosa*: why so many? *Trends Microbiol* 2000;**8**:498–504.
- Rojas Murcia N, Lee X, Waridel P et al. The *Pseudomonas aeruginosa* antimetabolite L-2-amino-4-methoxy-trans-3-butenoic acid (AMB) is made from glutamate and two alanine residues via a thio-template-linked tripeptide precursor. *Front Microbiol* 2015;**6**:170.
- Roy PH, Tetu SG, Larouche A et al. Complete genome sequence of the multiresistant taxonomic outlier *Pseudomonas aeruginosa* PA7. *PLoS One* 2010;**5**:e8842.
- Sage AE, Proctor WD, Phibbs PV Jr. A two-component response regulator, *gltR*, is required for glucose transport activity in *Pseudomonas aeruginosa* PAO1. *J Bacteriol* 1996;**178**:6064–6.
- Salvi F, Agniswamy J, Yuan H et al. The combined structural and kinetic characterization of a bacterial nitronate monooxygenase from *Pseudomonas aeruginosa* PAO1 establishes NMO class I and II. *J Biol Chem* 2014;**289**:23764–75.
- Schertzer JW, Whiteley M. A bilayer-couple model of bacterial outer membrane vesicle biogenesis. *Mbio* 2012;**3**, DOI: 10.1128/mbio.00297-11.
- Schobert M, Jahn D. Anaerobic physiology of *Pseudomonas aeruginosa* in the cystic fibrosis lung. *Int J Med Microbiol* 2010;**300**:549–56.
- Schooling SR, Beveridge TJ. Membrane vesicles: an overlooked component of the matrices of biofilms. *J Bacteriol* 2006;**188**:5945–57.
- Schreiber K, Krieger R, Benkert B et al. The anaerobic regulatory network required for *Pseudomonas aeruginosa* nitrate respiration. *J Bacteriol* 2007;**189**:4310–4.
- Schulz S, Eckweiler D, Bielecka A et al. Elucidation of sigma factor-associated networks in *Pseudomonas aeruginosa* reveals a modular architecture with limited and function-specific crosstalk. *PLoS Pathog* 2015;**11**:e1004744.
- Schurr MJ, Yu H, Martinez-Salazar JM et al. Control of AlgU, a member of the sigma E-like family of stress sigma factors, by the negative regulators MucA and MucB and *Pseudomonas aeruginosa* conversion to mucoidy in cystic fibrosis. *J Bacteriol* 1996;**178**:4997–5004.
- Schuster M, Lostroh CP, Ogi T et al. Identification, timing, and signal specificity of *Pseudomonas aeruginosa* quorum-controlled genes: a transcriptome analysis. *J Bacteriol* 2003;**185**:2066–79.
- Schweizer HP. Efflux as a mechanism of resistance to antimicrobials in *Pseudomonas aeruginosa* and related bacteria: unanswered questions. *Genet Mol Res* 2003;**2**:48–62.
- Siehnel RJ, Egli C, Hancock RE. Polyphosphate-selective porin OprO of *Pseudomonas aeruginosa*: expression, purification and sequence. *Mol Microbiol* 1992;**6**:2319–26.
- Siehnel RJ, Worobec EA, Hancock RE. Cloning of the *Pseudomonas aeruginosa* outer membrane porin protein P gene: evidence for a linked region of DNA homology. *J Bacteriol* 1988;**170**:2312–8.
- Skovierova H, Rowley G, Rezuchova B et al. Identification of the sigmaE regulon of *Salmonella enterica* serovar Typhimurium. *Microbiology* 2006;**152**:1347–59.
- Skurnik D, Roux D, Cattoir V et al. Enhanced in vivo fitness of carbapenem-resistant *oprD* mutants of *Pseudomonas aeruginosa* revealed through high-throughput sequencing. *P Natl Acad Sci USA* 2013;**110**:20747–52.
- Smith SG, Mahon V, Lambert MA et al. A molecular Swiss army knife: OmpA structure, function and expression. *FEMS Microbiol Lett* 2007;**273**:1–11.
- Sriramulu DD, Lunsdorf H, Lam JS et al. Microcolony formation: a novel biofilm model of *Pseudomonas aeruginosa* for the cystic fibrosis lung. *J Med Microbiol* 2005;**54**:667–76.
- Stewart RM, Wiehlmann L, Ashelford KE et al. Genetic characterization indicates that a specific subpopulation of *Pseudomonas aeruginosa* is associated with keratitis infections. *J Clin Microbiol* 2011;**49**:993–1003.
- Sugawara E, Nagano K, Nikaido H. Factors affecting the folding of *Pseudomonas aeruginosa* OprF porin into the one-domain open conformer. *Mbio* 2010;**1**, DOI: 10.1128/mbio.00228-10.
- Sugawara E, Nagano K, Nikaido H. Alternative folding pathways of the major porin OprF of *Pseudomonas aeruginosa*. *FEBS J* 2012;**279**:910–8.
- Sugawara E, Nestorovich EM, Bezrukov SM et al. *Pseudomonas aeruginosa* porin OprF exists in two different conformations. *J Biol Chem* 2006;**281**:16220–9.
- Sugawara E, Nikaido H. OmpA protein of *Escherichia coli* outer membrane occurs in open and closed channel forms. *J Biol Chem* 1994;**269**:17981–7.
- Tamber S, Hancock RE. Involvement of two related porins, OprD and OprP, in the uptake of arginine by *Pseudomonas aeruginosa*. *FEMS Microbiol Lett* 2006;**260**:23–9.
- Tamber S, Maier E, Benz R et al. Characterization of OprD, a *Pseudomonas aeruginosa* porin involved in the uptake of tri-carboxylates. *J Bacteriol* 2007;**189**:929–39.
- Tamber S, Ochs MM, Hancock RE. Role of the novel OprD family of porins in nutrient uptake in *Pseudomonas aeruginosa*. *J Bacteriol* 2006;**188**:45–54.
- Tata M, Wolfinger MT, Amman F et al. RNASeq based transcriptional profiling of *Pseudomonas aeruginosa* PA14 after short- and long-term anoxic cultivation in synthetic cystic fibrosis sputum medium. *PLoS One* 2016;**11**:e0147811.
- Touw DS, Patel DR, van den Berg B. The crystal structure of OprG from *Pseudomonas aeruginosa*, a potential channel for transport of hydrophobic molecules across the outer membrane. *PLoS One* 2010;**5**:e15016.
- Toyofuku M, Roschitzki B, Riedel K et al. Identification of proteins associated with the *Pseudomonas aeruginosa* biofilm extracellular matrix. *J Proteome Res* 2012;**11**:4906–615.
- Trias J, Nikaido H. Protein D2 channel of the *Pseudomonas aeruginosa* outer membrane has a binding site for basic amino acids and peptides. *J Biol Chem* 1990a;**265**:15680–4.
- Trias J, Nikaido H. Outer membrane protein D2 catalyzes facilitated diffusion of carbapenems and penems through the outer membrane of *Pseudomonas aeruginosa*. *Antimicrob Agents Ch* 1990b;**34**:52–7.
- Trunk K, Benkert B, Quack N et al. Anaerobic adaptation in *Pseudomonas aeruginosa*: definition of the Anr and Dnr regulons. *Environ Microbiol* 2010;**12**:1719–33.

- Turner KH, Everett J, Trivedi U et al. Requirements for *Pseudomonas aeruginosa* acute burn and chronic surgical wound infection. *PLoS Genet* 2014;**10**:e1004518.
- Turner KH, Wessel AK, Palmer GC et al. Essential genome of *Pseudomonas aeruginosa* in cystic fibrosis sputum. *P Natl Acad Sci USA* 2015;**112**:4110–5.
- Udekwi KI, Wagner EG. Sigma E controls biogenesis of the anti-sense RNA MicA. *Nucleic Acids Res* 2007;**35**:1279–88.
- van den Berg B. Structural basis for outer membrane sugar uptake in pseudomonads. *J Biol Chem* 2012;**287**:41044–52.
- Venturi V. Regulation of quorum sensing in *Pseudomonas*. *FEMS Microbiol Rev* 2006;**30**:274–91.
- Wagner VE, Bushnell D, Passador L et al. Microarray analysis of *Pseudomonas aeruginosa* quorum-sensing regulons: effects of growth phase and environment. *J Bacteriol* 2003;**185**:2080–95.
- Walzer G, Rosenberg E, Ron EZ. Identification of outer membrane proteins with emulsifying activity by prediction of beta-barrel regions. *J Microbiol Methods* 2009;**76**:52–7.
- Wang H, Andersen KK, Vad BS et al. OmpA can form folded and unfolded oligomers. *Biochim Biophys Acta* 2013;**1834**:127–36.
- Wang Y, Zhao X, Sun B et al. Molecular dynamics simulation study of the vanillate transport channel of Opdk. *Arch Biochem Biophys* 2012;**524**:132–9.
- Wei Q, Minh PN, Dötsch A et al. Global regulation of gene expression by OxyR in an important human opportunistic pathogen. *Nucleic Acids Res* 2012;**40**:4320–33.
- Wei Q, Tarighi S, Dötsch A et al. Phenotypic and genome-wide analysis of an antibiotic-resistant small colony variant (SCV) of *Pseudomonas aeruginosa*. *PLoS One* 2011;**6**:e29276.
- Wessel AK, Liew J, Kwon T et al. Role of *Pseudomonas aeruginosa* peptidoglycan-associated outer membrane proteins in vesicle formation. *J Bacteriol* 2013;**195**:213–9.
- Williams P, Camara M. Quorum sensing and environmental adaptation in *Pseudomonas aeruginosa*: a tale of regulatory networks and multifunctional signal molecules. *Curr Opin Microbiol* 2009;**12**:182–91.
- Winsor GL, Griffiths EJ, Lo R et al. Enhanced annotations and features for comparing thousands of *Pseudomonas* genomes in the *Pseudomonas* genome database. *Nucleic Acids Res* 2016;**44**:D646–53.
- Wolter DJ, Hanson ND, Lister PD. Insertional inactivation of *oprD* in clinical isolates of *Pseudomonas aeruginosa* leading to carbapenem resistance. *FEMS Microbiol Lett* 2004;**236**:137–43.
- Wood LF, Leech AJ, Ohman DE. Cell wall-inhibitory antibiotics activate the alginate biosynthesis operon in *Pseudomonas aeruginosa*: roles of sigma (AlgT) and the AlgW and Prc proteases. *Mol Microbiol* 2006;**62**:412–26.
- Wright EA, Di Lorenzo V, Trappetti C et al. Divergence of a strain of *Pseudomonas aeruginosa* during an outbreak of ovine mastitis. *Vet Microbiol* 2015;**175**:105–13.
- Wu L, Estrada O, Zaborina O et al. Recognition of host immune activation by *Pseudomonas aeruginosa*. *Science* 2005;**309**:774–7.
- Wylie JL, Worobec EA. Cloning and nucleotide sequence of the *Pseudomonas aeruginosa* glucose-selective OprB porin gene and distribution of OprB within the family Pseudomonadaceae. *Eur J Biochem* 1994;**220**:505–12.
- Wylie JL, Worobec EA. The OprB porin plays a central role in carbohydrate uptake in *Pseudomonas aeruginosa*. *J Bacteriol* 1995;**177**:3021–6.
- Xiong J, Alexander DC, Ma JH et al. Complete sequence of pOZ176, a 500-kilobase IncP-2 plasmid encoding IMP-9-mediated carbapenem resistance, from outbreak isolate *Pseudomonas aeruginosa* 96. *Antimicrob Agents Ch* 2013;**57**:3775–82.
- Yamano Y, Nishikawa T, Komatsu Y. Cloning and nucleotide sequence of anaerobically induced porin protein E1 (OprE) of *Pseudomonas aeruginosa* PAO1. *Mol Microbiol* 1993;**8**:993–1004.
- Yamano Y, Nishikawa T, Komatsu Y. Involvement of the RpoN protein in the transcription of the *oprE* gene in *Pseudomonas aeruginosa*. *FEMS Microbiol Lett* 1998;**162**:31–7.
- Yang J, Yan R, Roy A et al. The I-TASSER Suite: protein structure and function prediction. *Nat Methods* 2015;**12**:7–8.
- Yang J, Zhang Y. I-TASSER server: new development for protein structure and function predictions. *Nucleic Acids Res* 2015;**43**:W174–81.
- Yang L, Jelsbak L, Molin S. Microbial ecology and adaptation in cystic fibrosis airways. *Environ Microbiol* 2011;**13**:1682–9.
- Yates JM, Morris G, Brown MR. Effect of iron concentration and growth rate on the expression of protein G in *Pseudomonas aeruginosa*. *FEMS Microbiol Lett* 1989;**49**:259–62.
- Ye L, Cornelis P, Guillemin K et al. Structure revision of N-mercaptop-4-formylcarbostyryl produced by *Pseudomonas fluorescens* G308 to 2-(2-hydroxyphenyl)thiazole-4-carbaldehyde [aeruginaldehyde]. *Nat Prod Commun* 2014;**9**:789–94.
- Yoneyama H, Nakae T. Mechanism of efficient elimination of protein D2 in outer membrane of imipenem-resistant *Pseudomonas aeruginosa*. *Antimicrob Agents Ch* 1993;**37**:2385–90.
- Yoneyama H, Yamano Y, Nakae T. Role of porins in the antibiotic susceptibility of *Pseudomonas aeruginosa*: construction of mutants with deletions in the multiple porin genes. *Biochem Biophys Res Commun* 1995;**213**:88–95.
- Yoon SS, Hennigan RF, Hilliard GM et al. *Pseudomonas aeruginosa* anaerobic respiration in biofilms: relationships to cystic fibrosis pathogenesis. *Dev Cell* 2002;**3**:593–603.
- Yoshihara E, Gotoh N, Nishino T et al. Protein D2 porin of the *Pseudomonas aeruginosa* outer membrane bears the protease activity. *FEBS Lett* 1996;**394**:179–82.
- Yoshihara E, Yoneyama H, Ono T et al. Identification of the catalytic triad of the protein D2 protease in *Pseudomonas aeruginosa*. *Biochem Biophys Res Commun* 1998;**247**:142–5.
- Zaborin A, Gerdes S, Holbrook C et al. *Pseudomonas aeruginosa* overrides the virulence inducing effect of opioids when it senses an abundance of phosphate. *PLoS One* 2012;**7**:e34883.
- Zschiedrich CP, Keidel V, Szurmant H. Molecular mechanisms of two-component signal transduction. *J Mol Biol* 2016;**428**:3752–75.