



HAL
open science

A green supply chain network design framework for the processed food industry: Application to the orange juice agrofood cluster

Marco Augusto Miranda Ackerman, Catherine Azzaro-Pantel, Alberto A. Aguilar-Lasserre

► To cite this version:

Marco Augusto Miranda Ackerman, Catherine Azzaro-Pantel, Alberto A. Aguilar-Lasserre. A green supply chain network design framework for the processed food industry: Application to the orange juice agrofood cluster. *Computers & Industrial Engineering*, 2017, 109, pp.369-389. 10.1016/j.cie.2017.04.031 . hal-01882499

HAL Id: hal-01882499

<https://hal.science/hal-01882499>

Submitted on 27 Sep 2018

HAL is a multi-disciplinary open access archive for the deposit and dissemination of scientific research documents, whether they are published or not. The documents may come from teaching and research institutions in France or abroad, or from public or private research centers.

L'archive ouverte pluridisciplinaire **HAL**, est destinée au dépôt et à la diffusion de documents scientifiques de niveau recherche, publiés ou non, émanant des établissements d'enseignement et de recherche français ou étrangers, des laboratoires publics ou privés.



Open Archive Toulouse Archive Ouverte

OATAO is an open access repository that collects the work of Toulouse researchers and makes it freely available over the web where possible

This is an author's version published in: <http://oatao.univ-toulouse.fr/20444>

Official URL: <https://doi.org/10.1016/j.cie.2017.04.031>

To cite this version:

Miranda-Ackerman, Marco Aaugusto^{ORCID} and Azzaro-Pantel, Catherine^{ORCID} and Aguilar-Lasserre, Alberto A. *A green supply chain network design framework for the processed food industry: Application to the orange juice agrofood cluster.* (2017) Computers & Industrial Engineering, 109. 369-389. ISSN 0360-8352

Any correspondence concerning this service should be sent to the repository administrator: tech-oatao@listes-diff.inp-toulouse.fr

A green supply chain network design framework for the processed food industry: Application to the orange juice agrofood cluster

Marco A. Miranda-Ackerman^{a,b}, Catherine Azzaro-Pantel^{b,*}, Alberto A. Aguilar-Lasserre^c

^a CONACYT-El Colegio de Michoacán, Sede La Piedad: Cerro de Nahuatzen 85, Fracc. Jardines del Cerro Grande, C.P. 59370 La Piedad, Michoacán, Mexico

^b Laboratoire de Genie Chimique, Université de Toulouse, CNRS, INP, UPS, Toulouse, France

^c Tecnológico Nacional de México, Instituto Tecnológico de Orizaba, DEPI, Av. Instituto Tecnológico 852, Col. Emiliano Zapata, 94300 Orizaba, Veracruz, Mexico

A B S T R A C T

Food production has put enormous strain on the environment. Supply chain network design provides a means to frame this issue in terms of strategic decision making. It has matured from a field that addressed only operational and economic concerns to one that comprehensively considers the broader environmental and social issues that face industrial organizations of today. Adding the term “green” to supply chain activities seeks to incorporate environmentally conscious thinking in all processes in the supply chain. The methodology is based on the use of Life Cycle Assessment, Multi-objective Optimization via Genetic Algorithms and Multiple-criteria Decision Making tools (TOPSIS type). The approach is illustrated and validated through the development and analysis of an Orange Juice Supply Chain case study modelled as a three echelon GrSC composed of the supplier, manufacturing and market levels that in turn are decomposed into more detailed subcomponents. Methodologically, the work has shown the development of the modelling and optimization GrSCM framework is useful in the context of eco-labelled agro food supply chain and feasible in particular for the orange juice cluster. The proposed framework can help decision makers handle the complexity that characterizes agro food supply chain design decision and that is brought on by the multi-objective nature of the problem as well as by the multiple stakeholders, thus preventing to make the decision in a segmented empirical manner. Experimentally, under the assumptions used in the case study, the work highlights that by focusing only on the “organic” eco-label to improve the agricultural aspect, low to no improvement on overall supply chain environmental performance is reached in relative terms. In contrast, the environmental criteria resulting from a full lifecycle approach is a better option for future public and private policies to reach more sustainable agro food supply chains.

1. Introduction

Society has currently evolved to understand that the human activities, including food production, are damaging the natural environment. According to [Vermeulen, Campbell, and Ingram \(2012\)](#), 19–29% of global emissions of greenhouse gases come from agriculture and food production systems. Looking closer to the European Union this same pattern stands - where agriculture and food production are main contributors to emissions related to Global Warming Potential (GWP). In contrast, the EU is one of the most responsive markets to environmentally conscious food products ([Ruiz de Maya, López-López, & Munuera, 2011](#)). Furthermore,

agriculture is the main contributor to other important environmental impacts, noticeably eutrophication with roughly a 50% share ([Tukker & Jansen, 2006](#)). Modern agricultural production systems use agrochemicals like fertilizers and pesticides, and fossil fuels for power machinery, that have increased the environmental footprint of food production. Further, energy and water demand for food processing systems also play an important part. In addition, food production is setup as a globally distributed network of suppliers, manufacturers and consumers. Transportation of the raw materials and food products around the world in order to satisfy global demands has also played a large role on the environmental impact. These factors combine to form the economic and environmental profile of most food products consumed in developing and advanced economies.

Most of the research works on improving the environmental performance of agro food productions systems has been done by

Nomenclature

Acronyms

AVUC	Average Variable Unit Cost
DC	Distribution Centre
FCOJ	From Concentrate Orange Juice
GrSCM	Green Supply Chain Management
GSCND	Green Supply Chain Network Design
GWP	Global Warming Potential
HHP	High Hydrostatic Pressure
KEPI	Key Environmental Performance Indicators
KPI	Key Performance Indicators
LCA	Life Cycle Assessment
MINLP	Mixed Integer Nonlinear Programming
MS	Multiple Strength
NFCOJ	Not From Concentrate Orange Juice
NLP	Nonlinear Programming
NPV	Net Present Value
PEF	Pulse Electric Field
PfS	Partnership for Sustainability
SC	Supply Chain
SCM	Supply Chain Management
SCND	Supply Chain Network Design
SP	Sales Price
SS	Single Strength
VUC	Variable Unit Cost

Index & Set

f	fabrication steps or stages performed to product F
i	label denomination I
p	fabrication technology P
r	supplying regions in R
r'	market region R'
s	suppliers in S
t	agricultural practice type used to produce fruit in T

Parameters

$\beta_{r,t}$	average yield per unit of land using agro practice t in region r (kg/ha)
$\omega_{r,s}$	land surface available for each supplier s in region r (ha)
$\delta_{r,t}$	average cost per unit of agricultural output in region r using agricultural practice t (\$/kg)
$\varphi_{r,t}$	average environmental impact per unit of agricultural output in region r using agricultural practice t (kg CO ₂ eq/kg)
$\varepsilon_{r,e}$	average cost of resource type e (electricity, gas, water) per region r and r'
γ_p	concentration ratio in Brix for raw materials type given technology p
$\Phi_{r,e}$	average environmental impact emissions due to consumption of resource e in region r
ρ	average output of raw juice per unit of fruit (i.e. 2.29 kg orange \approx 1 L of juice)
$\lambda_{f,e,p}$	average quantity of resource e needed to operate fabrication stage f using technology p
$\varepsilon_{r',e}$	cost of resource type e (electricity, gas, water, materials) in region r'
StdCap _{p}	standard capacity of equipment of technology p
StdCC _{f,p}	standard capital cost of equipment of technology p

Decision variables

BR _{r}	binary variable to select the sourcing region r (Mexico, Brazil)
------------------------------	--

BS _{r,s}	binary variable to select suppliers s {0,1} in region r (Mexico, Brazil)
D _{i,f,m,r'}	integer variable to define the quantity of demand that will be targeted of product label type i processing type f for market m in region r'
IL r'	integer variable to select the location for bottling plant in region r' {1,6}
IP f	technology for fabrication step f {0,1} {1,3}
IT s	integer variable to select the agro practice at orchard/-supplier s {1,4}
IS s	integer variable to define the percentage of land surface contracted {50–100}

Problem variables

A_j	amortization per period j
AOC _{f,p}	annual operations cost for manufacturing step f using technology p
ASC _{t}	annual supplier (operation) cost per type of agro practice t
ASEI _{t}	annual supplier environmental impact emissions per type of agro practice t
BMC _{p}	bottling operations cost per type of bottling technology p
BMEI _{p}	bottling operations environmental impact emissions per type of bottling technology p
Cap _{f} ^{IN}	intake capacity of fabrication step f
Cap _{f} ^{OUT}	output capacity of fabrication step f
C_j	total variable cost in period j
D _{i,f,m,r'}	demand targeted of product label type i processing type f for market m in region r'
f_L	lang factor
InvCost _{f}	capital cost installed capacity for fabrication step f
LandArea _{r,s}	land area contracted of supplier s in region r
LLD _{i,f,m,r'}	demand lower limit for product label type i processing type f for market m in region r'
OpCost _{r,s,t}	annual operations cost of each supplier s in region r using agro practice t
OpEI _{r,s,t}	annual operations environmental impact measurement for each supplier s in region r using agro practice t
$Q_A \rightarrow B_{i,f,m,r'}$	quantity of intermediate product label type i processing type f for market m in region r' to be sent from location A to location B
RM _{i} ^{batt}	quantity of bottled final product required of label type i
RM _{i} ^{conct}	quantity of concentrated juice intermediate product required of label type i
RM _{i} ^{juice}	quantity of raw juice intermediate product required of label type i
RM _{i} ^{orange}	quantity of orange raw material required of label type i
RM _{i} ^{past}	quantity of pasteurized juice intermediate product required of label type i
RMUC _{i} ^{batt}	bottled final product variable unit cost of label type i
RMUC _{i} ^{conct}	concentrated juice intermediate product variable unit cost of label type i
RMUC _{i} ^{orange}	orange raw material variable unit cost of label type i
RMUC _{i} ^{past}	pasteurized juice intermediate product variable unit cost of label type i
SP _{i,f,m,r'}	sales price per unit of product label type i processing type f for market m in region r'
TotalCapacity _{t}	total orange raw material production capacity per type of agro practice t

TUC A \rightarrow $B_{i,f,m,r'}$ variable unit cost of transporting for intermediate product from location A to location B
TUEI A \rightarrow $B_{i,f,m,r'}$ variable unit environmental impact emissions of transporting for intermediate product from location A to location B

ULD $_{i,f,r',m}$ demand upper limit for product label type i processing type f for market m in region r
 V_j total sales income in period j
VUC $_{i,f,m,r'}$ variable unit cost for final product label type i processing type f for market m in region r'

parts, this is to say, many LCA studies have been performed to measure and study alternatives in the agricultural and food manufacturing process designs (Roy et al., 2009). Other studies have been carried out comparing scenarios or technological alternatives from an environmental point of view (Sonesson et al., 2016). Moreover, economic and operational improvements have been studied extensively from tactical, operational and strategic point of views for agro food SCs (Ahumada & Villalobos, 2009; Apaiah & Hendrix, 2005; Miranda-Ackerman, Fernández-Lambert, Azzaro-Pantel, & Aguilar-Lasserre, 2014). Green supply chain management, and more specifically Green Supply Chain Network Design (GSCND) provide a powerful tool to integrate these two complementary strategies (Eskandarpour, Dejax, Miemczyk, & Péton, 2015; Seuring & Muller, 2008; Srivastava, 2007).

Supply chains are viewed as networks of elements that involve suppliers, manufacturers, distributors among other stakeholders and reflect materials, information and economic flows. They are physically constructed of natural resource extraction facilities, processing facilities, manufacturing plants, trucks, sea vessels, warehouses, etc. . . , that are located in different locations around the world. Supply Chain Network Design (SCND) involves a decision and model framework that searches “through one or a variety of metrics, for the “best” configuration and operation of all of these (SC network) elements” (Garcia & You, 2015). Some of the most important challenges that SCND holds reflect the issues that complex real systems faces including for example decisions at multiple scales, multiple levels, multiple periods, multiple objectives and undoubtedly multiple stakeholders.

SCND consists in formulating the SC network as nodes and arcs that connect, featured in layers for each echelon that constructs the SC of interest. In each layer, several alternatives are presented that can represent differences in modes of transport, technologies used, geographical locations of sites, among many other choices, while the arcs may represent attributes and criteria of interest such as distances, costs, time periods, etc. The process of optimizing the SCND is to find the best configuration of the network, this is to say, the best route of arcs and nodes that fulfil the single or multiple objectives that are of interest to the decision maker. It is important to highlight that the “green” reference in GSCND is related to the fact that conventional SCND problem formulations exclude environmental performance measurements and criteria in the design processes; GSCND encompasses the supply chain scope with environmental performance metrics (Farahani, Rezapour, Drezner, & Fallah, 2014; Sharma, Chandna, & Bhardwaj, 2017) at early design stage, in the case of this study it is Global Warming Potential (GWP) measured in CO₂ equivalent emissions.

This paper is organised as follows. In Section 2, we present the work position among the state-of-the-art literature review on green supply chain optimization and its application to food. Section 3 provides the methods and tools used. Section 4, which presents the GSCND framework and scope is then followed in Section 5 by its mathematical formulation. In Section 6, we apply the proposed framework to the case study of orange juice cluster. The obtained results and discussion are developed in Section 7. Finally, in Section 8, we close with a summary of the main results and some perspectives.

2. Work position and literature review

Although much progress has been made in this field, some of the key advantages and possible applications of the SCM model have not yet or only scarcely been included in GrSCM body of research (Eskandarpour et al., 2015): especially, the development of efficient multiobjective models that adequately addresses the different dimensions of sustainable development is considered as a cornerstone to tackle the problem.

The GSCND approach that is targeted in this work is the formulation of supply chain design as a network of interconnected possible configurations of items for each echelon in the context of an agro-food supply chain. It is formulated as a pure integer non-linear problem with multiple objective functions in order to find the optimal trade-off configuration considering not only operational or economic criteria, but also environmental ones. In order to handle the complexity of the model structure and its components, a multiobjective genetic algorithm is proposed to find the so-called Pareto optimal solutions. Such strategies have proven to be powerful tools to solve SCND problems (Altıparmak, Gen, Lin, & Karaoglan, 2009; Costa, Celano, Fichera, & Trovato, 2010). Let us recall that the concept of “optimality” does not apply directly in the multiobjective setting so that the concept of Pareto optimality is particularly efficient. A solution vector is said to be Pareto optimal for a multiobjective problem if all other potential solution vectors have a higher value for at least one of the objective functions or have the same value for all the objective functions. This allows the model to overcome the combinatorial nature of the problem formulation. In addition, a multiple criteria decision making tool is used as a means to find the “best” trade-off solutions. This technique allows the decision maker to categorize the best solutions through a comprehensive method without bias.

The main contribution of this proposal is that it considers three main factors that have not been yet integrated into a model in the context of GSCND to our knowledge: (1) **Organic vs. conventional raw materials**: the evaluation of parallel flows of raw materials based on different agricultural practices used and final product outputs based on the use of concentration process is studied in this work; this is important because of the implication on final product quantities to be produced of each type of product and its relation to economic incentives to produce one or another type of product; (2) **Green consumer behaviour**: the model allows for the evaluation of different pricing strategies based on consumer willingness to pay different prices given specific attributes of the final product, specifically the different product types based on organic labelling have been rarely explored in GSCND problems; (3) **Technology selection**: given the nature of food production and transformation to be highly energy intensive, indirectly through agrochemical production and directly through high pressure and heat unit operations, the model provides a strategic decision framework that includes the evaluation of the environmental and economic effect of non-traditional capital investments: for example, the case study evaluates conventional high temperature multi-effect evaporation for the concentration stage of orange juice production vs. more unconventional technologies that can operate with reduced heat requirements such as freeze concentration and reverse osmosis.

2.1. Organic vs. conventional raw materials

Issues related to farming have been considered in recent multi-objective optimization models for food products. Recently (Mohammed & Wang, 2017) have proposed a fuzzy multiobjective distribution plan for meat products, and a multiobjective optimization approach in terms of sustainable supply chain optimization applied to a chemical production supply chain case study has been reported in Zhang, Shah, Wassick, Helling, and van Egerschot (2014). But no mention of eco-labelling restrictions or product differentiation at market based on consumer preference for greener product is considered.

One of the most widely used technique is Life Cycle Assessment (LCA) to aid in the decision making process by providing a means to evaluate the impacts on human health, the ecosystem and the natural resource depletion at some or all the stages in the life span of a product, service or system (Joliet, Saadé, & Crettaz, 2010). By integrating these two approaches, the scope of SCM is extended to include key criteria offered by EA, thus allowing for the classical economic and operational objectives to be evaluated at the same time as social and environmental issues, when trying to holistically design or improve the overall performance of a production system in a sustainable viewpoint.

In the approach presented here, attention is given to the peculiarities that food supply chains have since raw materials sourcing is fundamental for agricultural systems and their environmental performance (Cerutti, Bruun, Beccaro, & Bounous, 2011). It also highlights the principles and use of *organic* eco-labelling in the food product industry. It finalizes with the introduction of the orange juice case study, the reasoning behind its illustrative selection and the possible ramifications of the technique to similar cases.

2.2. Green consumer behaviour

The work presented in Coskun, Ozgur, Polat, and Gungor (2016) takes this last point as central and the evaluation of consumer preference to three types of products based on the attribute of “greenness” is modelled within a supply chain decision framework. The limitation of the modelling approach yet lies in the decision variables being evaluated: no operational or tactical decisions are formulated such as technologies to be used, instead different levels of “green production capability” without further detail form the decision components related to production greenness. Furthermore, the study is a generalized model assuming no specific characteristics of the product being produced. This is a good first step in taking into account consumer preference for green products vs conventional ones, but in the context of food products this is limited by eco-labelling rules related to farming practices for many marketed countries and their labelling regulations (Czarnezki, 2011). It is important to highlight that including green consumer behaviour within a supply chain design process is a new field based on knowledge that has been gathered within the marketing field (Brindley & Oxborrow, 2014; Chan, He, & Wang, 2012; Rousseau & Vranken, 2013). This leads to many research opportunities to further develop given that drivers for market share for green products and the related competitive pressures are some of the important issues recently detected in review studies on green supply chain and their indicators in agrofood industries (Bloemhof, van der Vorst, Bastl, & Allaoui, 2015; Eskandarpour et al., 2015).

2.3. Technology selection

The aim of the proposed framework is the optimization of the agro-food supply chain design, planning and operations through

the implementation of appropriate green supply chain management and green logistics principles. In the current literature there have been works that integrate this GHG emission minimization in a multiobjective modelling strategy. Some of the most seminal proposals of this modelling strategy take into account technology selection among other supply chain network design decision making. Guillén-Gosálbez and Grossmann (2009) propose a bi-criteria stochastic mixed integer nonlinear program that maximize Net Present Value (NPV) and minimizes environmental impact measured through Eco-indicator 99. The strategy is applied to chemicals production supply chain model with Plant-Warehouse-Market echelons applied to a set of case studies. This work was an improvement of the proposal of Hugo and Pistikopoulos (2004) that also took into account technology selection within a multiobjective modelling framework. They proposed a mixed-integer programming approach to model the selection, allocation and capacity applied to chemicals production supply chain. In the recent review on sustainable supply chain network design from Eskandarpour et al. (2015) the selection of technology is noted on nine articles but most are related to waste management and chemical production. Seminal review papers from Seuring and Muller (2008) and Srivastava (2007) do not categorize the selection of technologies, within the framework of the supplier selection problem. One outlier is (Amin & Zhang, 2013) that proposed the use of parameter selection as a means to evaluate cleaner technologies and environmentally friendly materials use. The modelling approach examines multiple plants, collection centres, demand markets and products in a closed-loop supply chain network framework. Although it does consider technology selection, it focuses on recycling and remanufacturing. In the context of the research focus of this paper, the integration of greener technologies and organic raw materials use for final products that can be carbon minimized and/or labelled as *organic* food is proposed.

3. Methods and tools

3.1. General consideration

The GSCND for agro-food industry problem targeted in this paper focuses on finding the optimal configuration of a four-echelon supply chain for orange juice, made up by the supplier, processing plant, bottling (packaging) plant and market as shown in; in addition, it has nested decisions at each echelon related to agricultural practice selection, technology selection, product mix (e.g. organic, conventional, from concentrate and non from concentrate orange juice) and market demand to be satisfied.

Each supply chain echelon has a set of control variables that affects the performance of each component that defines it. These control or decision variables of integer type are: (A) Supplier Echelon Decision Variables (81): Raw materials sourcing region location, Supplier selection, Agro practice selection, Land area contracted (Agricultural output capacity); (B) Processing Echelon Decision Variables (2): Processing technology selection; (C) Bottling Echelon Decision Variables (4): Bottling plant location, Bottling technology selection; (D) Market Echelon Decision Variables (80): Demand coverage (product mix and system wide capacity).

These variables are subject to two main sets of constraints. The first set involves lower and upper bounds of the values that the decision variables can take during the optimization process. These bounds represent the operational capabilities or value limits evaluated during the optimization process. The second set of constraints represent the feasibility of the network, in other words the interdependencies and operational limitations of the process system under consideration, encompassing mass balance and demand constraints. In addition, the objective functions are

constituted by a set of equations describing the system decomposed into three groups: (1) Operational and economic functions; (2) Environmental impact functions; (3) Transportation functions.

These constraints and set of function systems are developed in Section 3.2. The general objective of this modelling approach is to capture all the complex interdependencies between the variables. The objective functions that will be considered are the following ones: (1) Maximization of the Net Present Value (NPV), defined as an indicator of the economic performance of a project as measured by the cumulative cash flows over time. It allows measuring the economic performance of the system in its full life cycle; (2) Minimization of Global Warming Potential (GWP): GWP is a measurement index that integrates the overall climate impact of an activity or system measured in a standardized form by CO₂ emissions equivalency; (3) Minimization of Variable Unit Cost (VUC): VUC is defined as the cost incurred to produce and deliver a product to a store or retailer; (4) Minimization of investment: this capital cost is related to the purchase and installation of processing equipment and facilities.

3.2. Modelling approach

The modelling approach proposed here is based on a multiobjective integer nonlinear formulation in agro-food systems. The final product is a discrete packaged product (i.e. 1 L of bottled orange juice, 1 can (320 mL) of tomato concentrate, etc.) and process capacity is thus estimated accordingly to the discrete final quantity of product that will be marketed. A formal definition in an abstract form is presented in (1). The set of minimization objective functions from 1 to n represents the set criteria (related to economic and environmental performance) that must be simultaneously optimized, subject to inequality and equality constraints represented by g and h functions. They represent the model framework via the interconnected and interdependencies between decision variables, dependent variables and parameters with respect to the feasibility of the system. The decision variables that are used are of binary and integer type represented by y and x respectively.

$$\begin{aligned} & \min [f_1(x, y, z), f_2(x, y, z), \dots, f_n(x, y, z)] \\ & \text{s.t. } g(x, y, z) \leq 0 \\ & h(x, y, z) = 0 \\ & y \in \{0, 1\}^m, x \in \mathbb{Z}^n \end{aligned} \quad (1)$$

Following the problem statement and abstract formulation, the formal mathematical model is proposed, using the general structure of the four-echelon supply chain. For the sake of illustration, a mathematical formulation is developed for each link in the chain and constructed in the abstract representation by using the case study of the orange juice production company as a support instance.

The historical and bibliographical data used for model implementation and validation is offered in the Appendices and throughout the case study description. The information that is provided is based on literature review from past and recent data on orange fruit and orange juice production (Curti-Díaz et al., 1998; Doublet, Jungbluth, Flury, Stucki, & Schori, 2013; Knudsen, de Almeida, Langer, de Abreu, & Halberg, 2011; Spitzley, Keoleian, & McDaniel, 1997). Additional data for environmental impact estimations are provided by using Simapro[®] software and EcoInvent 2.2 database.

3.3. Solution approach

The problem formulation is based on a two-stage process: Multiobjective Optimization (MOO) and Multiple Criteria Decision Making (MCDM) process.

3.3.1. Multiobjective optimization

The former stage, MOO, can be solved through a limited number of techniques. The weighted sum method, utility method, lexicographic, epsilon-constraint (De-León Almaraz, Azzaro-Pantel, Montastruc, Pibouleau, & Senties, 2013) are among the most cited MOO solving methods. A very interesting alternative is to use metaheuristic methods, in particular genetic algorithms (Cortez, 2014; Yang, 2008). These techniques allow to find feasible heuristic solutions (Collette & Siarry, 2003; Cortez, 2014). For a monocriterion viewpoint, the main disadvantage is that when using these techniques there is no guarantee of finding solutions that are near the global optimal. The quality of the solution is generally dependent on the implementation, analysis and intuition of the modeller to overcome local optima. Some Mixed Integer Programming techniques implemented in modern solvers, such as CPLEX and GUROBI could also be used for solving this problem once it has been converted into an MILP. The GA strategy has yet proven to be valuable when modelling complex SCND problems (Miranda-Ackerman et al., 2014) involving nonlinear formulation. In order to have a generic formulation that could be applied to nonlinear problems, a GA has been selected in this work. Recent publications in the context of green chain design show a recurrent use of GA (Ahumada & Villalobos, 2009; Arkeman & Jong, 2010; Yeh & Chuang, 2011). The solving method used here is based on a multiobjective genetic algorithm through the Non-dominated Sorting Genetic Algorithm II (NSGA-II) (Deb, Pratap, Agarwal, & Meyarivan, 2002). This algorithm is a population based stochastic search algorithm that produces Pareto non-dominated solutions. In contrast to other techniques such as weighted sum or lexicographic methods, that are *a priori* technique (i.e. a weight or order of the objectives as a matter of choice prior to the execution is needed), multiobjective GA referred as an *a posteriori* method produces a set of solutions (the so-called Pareto front) to choose from Cortez (2014), this is to say, without prior judgment or decision making. The NSGA-II is implemented through the so-called MULTIGEN library developed by Gomez et al. (2010) that allowed to perform evaluations, data analysis and visualization for the case study presented.

The use of NSGA-II as the stochastic search algorithm with the values used for these parameters is summarized in Table 1. They are fixed based on both empirical trial-and-error experience and on sensitivity analysis (Dietz, Azzaro-Pantel, Pibouleau, & Domenech, 2006). A higher number of individuals in the population associated with a higher number of generations used for scenario 1 compared to that used for scenarios 2–4 (i.e. a double value) is used to overcome the difficulties encountered in stochastic search methods involving equality constraints. It must be highlighted that a relatively high value for mutation rate (i.e. 0.5) was adopted which can be considered inconsistent compared to what occurs in natural evolution. This phenomenon was already observed in mixed integer problems similar to the pure integer problem treated in this work (Dietz et al., 2006; Gomez et al., 2010).

3.3.2. Multicriteria decision making strategy

Since GA is a guided random search method, its application can give us an idea of where the Pareto front lies. These solutions represent SC network design configurations that produce comparably

Table 1
Parameter set for multiobjective GA.

	Scenario 1	Scenario 2–4
Population size	200	400
Nr. of generations	400	800
Cross-over rate	0.9	0.9
Mutation rate	0.5	0.5

good outcomes in terms of the multiple objectives, this is to say trade-off between the objectives is made in order to find solutions. The aim of MCDM is to aid the decision-maker to select the best alternative. The objectives and preferences of the decision makers and stakeholders play a role in choosing the model structure and characteristics, but a non-bias and systematic approach should be taken when choosing the final solution alternative. This is especially important in multiobjective formulations, also known as, multicriteria decisions, because it is difficult to make judgments on complex higher dimensional solution alternatives. To aid the decision maker, a wide range of MCDM tools including methods such as ELECTRE, PROMETHEE, AHP, TOPSIS, thoroughly evaluated by [Zanakis and Solomon \(1998\)](#), provide a systematic and dimension independent ranking framework to compare and rank solutions based on multiple criteria.

TOPSIS (Technique for Order of Preference by Similarity to Ideal Solution), according to ([Eraslana, 2015](#); [Kim, Park, & Yoon, 1997](#)) has advantages over the other main methods, mainly: (1) it provides a scalar value that accounts for best and worst alternatives concurrently; (2) a logical approach that represents the human choice process; (3) the performance measurements for all alternatives can be visualized on a polyhedron, at least for any two dimensions; (4) simple to implement algorithm. In addition we use the M-TOPSIS a modified version of the TOPSIS method outlined by [Ren, Zhang, Wang, and Sun \(2010\)](#). This method helps overcoming some evaluation failures that occur in the original TOPSIS method such as top rank reversal ([Eraslana, 2015](#); [Zanakis & Solomon, 1998](#)).

The implementation of M-TOPSIS as an algorithm was coded through the Excel[®] environment. Because the GA output is given as Excel[®] worksheet tables, it was natural to couple the optimization output to the decisions analysis technique through this environment.

The interest of using GA at the first step of the methodology is that no weight is assigned to influence the search so that the whole Pareto front can be generated in one run. GA results are sets of trade-off solutions in the solution space, that have been found based on the criteria being evaluated. At the second step, the preferences of the decision maker via M-TOPSIS can be reflected based on the previously obtained optimal solutions by only ranking these solutions: it does not change the location of the solutions being found during the optimization process. Unless explicitly mentioned, the same weight is allocated to each criterion. It must be yet highlighted that different values can also be used reflecting the preference of a stakeholder under real world decision-making environment.

4. GSCND framework & scope

Although the proposed approach has the ambition to be generic enough to be applied to a wide range of agro-food systems that have similar characteristics, the problem formulation is supported here by the case study of the orange juice supply chain previously introduced.

4.1. Supplier echelon

Sourcing Region Selection models the selection of a single supplying region (e.g. a country). This decision level reflects the selection of the supplier set selection and processing plant location. The supplying region guarantees that suppliers are located near one another and share similar characteristics and behaviour such as yield, resources, quality, etc., so that average values shared by clusters of suppliers, for long term planning purposes are considered. This selection level is rooted on the principles of developing a Partnership for Sustainability with the suppliers that integrates life cycle assessment, environmental collaborations, and contract

farming in order to gain the social and environmental benefits related to these paradigms to get closer to a sustainable supply chain ([Miranda-Ackerman, 2015](#)).

By only selecting one region, information and technological resources are concentrated as a long-term planning project. This regional limitation also narrows the list of potential suppliers to those that can share a single initial processing plant (limiting capital investment). This condition is necessary because initial processing of food is carried out to minimize or eliminate spoilage of the raw material during handling and transportation. It becomes then a *de facto* plant location decision with its own components and connections to other decision levels. This is to say that other forces such as regional cost of resources (e.g. energy, water, etc.) needed to operate the processing plant and the distance of sourcing region to market regions are also connected. Resources have an effect on the processing plant location decision, because depending on the location site, local energy and water cost will be more or less expensive.

Supplier selection, agro practice & raw materials capacity.

The choice in this level is a three-part nested decision, involving: (1) The choice of suppliers: a set of suppliers with fixed land capacities are preselected to be considered within the region selected in the supplier echelon; (2) The definition of capacity that will be contracted: once suppliers are selected, a portion or the full land capacity for each one can be contracted to guarantee raw material requirements for downstream processing; (3) And the agricultural practice that will be used: the contract is formulated as a capacity guarantee contract-farming scheme. This contract scheme allows the Focal Company to define not only the land surface under contract but also the type of agricultural practice that is to be used. In the SCM paradigm as in the GrSCM, a central or focal company (FC) as proposed in [Seuring and Muller \(2008\)](#) is characterized by being the designer or owner of the product or service offered, governing the supply chain, and having contact with all SC stakeholders including the customers. The FC can also sometimes be the processing or manufacturing company, as in the case study.

In the case study the agricultural practice defines the quality and yield of the product output. The agricultural practices for the case study are divided into four categories based on the classification proposed by [Curti-Díaz et al. \(1998\)](#): (1) *Organic*, where agrochemicals are not used; (2) *Green or quasi-organic*, where the use of agrochemical such as pesticides or fertilizers is limited; (3) *Standard* use of conventional types and quantities of agrochemicals; (4) *Intensive* use of agrochemicals and other agricultural technologies that enhance performance. This family of 4 types of products will be considered in what follows.

4.2. Processing echelon

Technology selection involves a choice among discrete values from a set of alternatives. For Pasteurization process two alternatives are proposed: (1) High Hydrostatic Pressure (HHP), (also known as High Pressure Processing (HPP)) is a non-thermal pasteurization technique by applying high isotactic pressure; (2) Pulse Electric Field (PEF), a non-thermal pasteurization process based on applying high voltage pulsed electric fields. For the Concentration Process three alternatives are proposed: (1) Multi-effect evaporators, that involve a thermal method that by heat evaporates water from the food product; (2) Freeze (concentration), is a separation method that removes heat from a mixture during which a component crystallizes; (3) Reverse Osmosis, is a pressure driven membrane process that separates water from the food mixture by physically filtering.

The technology selection choice is interconnected with the selection of the supplying regions, because depending on the region the economic and environmental cost of resources will be

different. Each technology alternative involves distinctive operational requirements in addition to capital cost (e.g. pulse electric field pasteurization technology is more electricity intensive and thus lower electric environmental and economic costs region would be a better choice. In region A, electricity is produced from nuclear energy (low GWP burden), and region B from coal burning (high GWP). Region A would be more attractive to install a plant if the technology selected is electricity intensive (in terms of GWP).

In addition, the operational performances of the processes are dependent on the technology used (e.g. orange juice can reach 66°Bx¹ concentration with evaporators, but only 44°Bx with freeze or reverse osmosis concentration). The different concentration levels will then induce different transport costs.

Capacity setting influences other decision levels. It is not explicitly modelled as a decision variable, but depends on the demand coverage that is targeted in the Market Echelon. For the case study, two attributes are allocated to the family of the above-mentioned 4 types of products, referring to label and process. The label can be either Organic or Conventional (connected to Sourcing Echelon); the process can involve either the concentration of orange juice (it will be denoted “From Concentrate Orange Juice”, FCOJ or FC) or no concentration (it will be denoted “Not From Concentrate Orange Juice”, NFCOJ or NFC). The Processing Echelon is influenced by the Market Demand coverage that is targeted in the Market Echelon.

It must be highlighted that one of the most important applications of the supply chain network design problem formulation is to determine logistical routes. Although it is possible to evaluate many distribution routing issues related to the distance between farmers and processing plants on the one hand and to the one between the processing plant and the port of departure on the second hand, these distances are not considered here as well as the selection of alternative ports of departure or arrival. This could yet easily be changed to accommodate different logistical distribution networks. This assumption is yet valid since their contribution is assumed to be low compared to those related to: (1) from port of departure to port of arrival; (2) from port of arrival to bottling plant; and (3) from bottling plant to market.

4.3. Bottling echelon

At this level two main issues are considered: (1) Packaging/bottling plant location and (2) packaging/bottling technology selection.

For the **plant location issue**, a set of possible packaging/bottling plant locations is considered, either as potential new installations or as capacity expansion of an existing plant. From this set of potential locations, only one can be chosen to serve all of the distribution centres located in major cities within the regional market. As abovementioned, the distances from the Port of Arrival to the Bottling Plant, as well as, the distances from the Bottling Plant to Markets are considered. The evaluation of distances between the chosen bottling plant location in relation to the port of arrival and to the distribution centres is reflected through the economic and environmental cost given the distance and quantity of raw material and product being distributed.

Furthermore, the **packaging/bottling technology** is evaluated as a technology selection problem similar to that described in the Processing Echelon section. The case study evaluates three different bottling technologies, i.e., glass bottles, plastic bottles and aseptic carton container, that are selected based on cost and environmental impact taken from Life Cycle Design study by the

United States Environmental Protection Agency (Spitzley et al., 1997).

4.4. Market echelon

The modelling approach is based on a **market driven supply chain**. Market decision framework focuses mainly on market demand coverage, this is to say, production capacity allocation to satisfy each markets' needs of each product type. A set of targeted markets that represents the main cities in a region is considered.

Demand is defined as a decision variable that can take values between upper and lower demand constraints for each city. The demand variables are used as production planning targets that define the capacities that are required in terms of raw materials production capacity, processing capacity and bottling capacity. By optimizing these demand coverage variables not only is the capacity set at each production stage defined, but also the allocation of the installed resources, since the planned production mix ratio between organic labelled and conventional label products as well as from FCOJ and NFCOJ is defined through these variables. Furthermore, these will condition the global environmental impact that the SC network design will yield.

In summary, the network design model is characterized by considering a long-term time horizon, lower and upper demand bounds, variable product pricing for each product type, fixed and variable investment costs associated with capacity installation or expansion of processing and packaging/bottling plants, variable transport costs on the economic side. In addition, the environmental impacts of each stage are captured through the GWP (kg CO₂ eq) measurement provided the agro practice, land use, energy consumption, water and material use. The objective is then to determine the optimal supply chain network considering simultaneously economic benefit and environmental impact.

5. Mathematical model

This section presents the mathematical formulation of the supply chain model related to materials flows and demand satisfaction. The case study serves here as a support of the methodology and each component and decision level is presented in detail.

5.1. Mass balance and demand constraints

In terms of materials flow, the network of suppliers, production plants and markets are reflected in a set of constraints that insure production capacities at each level in the supply chain can meet market demand requirements.

5.1.1. Supplier echelon

First, production output has to match market demand. For this purpose, a necessary condition is the procurement of the raw materials from the suppliers, divided in our case study into organically and conventionally grown orange orchard fields. The first two echelons, i.e. supplier and processing are displayed in order to visualize the flow of raw materials along the two links in Fig. 2.

The **TotalCapacity_t** variable refers to the total capacity of the supplier network and sums the total capacity of all suppliers capacities **QC_{r,s,t}** given the agricultural practice used **t**.

$$TotalCapacity_t = \sum_s QC_{r,s,t}; \quad \forall r, s, t \quad (2)$$

The capacity contracted from each supplier is **QC_{r,s,t}**, as a function of the **LandArea_{r,s}** and the average output yield per land surface unit **β_{r,t}**

$$QC_{r,s,t} = LandArea_{r,s} \times \beta_{r,t}; \quad \forall r, s, t \quad (3)$$

¹ °Bx or degrees Brix refers to the measurement of the sugar content of an aqueous solution.

Table A1 summarizes the average output, cost and environmental impact relative to the region and the agricultural practice being used for the case study. They have been established from the information given in Consejo Citrícola Poblano (2004) for Mexico and in Knudsen et al. (2011) and Oelofse et al. (2010) for Brazil.

The $LandArea_{r,s}$ (4) is defined by the selection of the region r through the BR_r binary variable, the land size parameter $\omega_{r,s}$ of each possible supplying orchard (in ha) (see Table A2), the binary variable $BS_{r,s}$ to be selected the suppliers s , part of the subset of S that are located in region r , and through the IS_s integer variable that defines the percentage of the total land area to be negotiated in the contract scheme.

$$LandArea_{r,s} = BR_r \times \omega_{r,s} \times BS_{r,s} \times IS_s; \quad \forall r, s, t \quad (4)$$

Eq. (4) imposes that only one region can be selected for the reasons detailed in point 4.1:

$$\sum_r BR_r = 1 \quad (5)$$

An explicit lower limit of the land being considered of at least 50% of the total land is set in the case study to ensure a fair contract with newly selected partners.

5.1.2. Processing echelon

Two flows of types of oranges that come out of the Supplier Echelon enter the first process box (e.g. pasteurization). In our case study these are oranges to be passed through pasteurization process where the raw material requirements are denoted by $RM_{i=org}^{orange}$ and $RM_{i=conv}^{orange}$. They are used in (6) and (7) respectively to constrain the lower and upper limits of the contracted production capacity from the suppliers to be equal or 10% more than the raw materials required in order to guarantee sufficient raw materials for the production capacity to be installed.

$$RM_{i=org}^{orange} \leq TotalCapacity_t \leq 1.1RM_{i=org}^{orange}; \quad \text{when } t = 1 \quad (6)$$

$$RM_{i=conv}^{orange} \leq \sum_{t=2}^4 TotalCapacity_t \leq 1.1RM_{i=conv}^{orange}; \quad \text{when } t = 2, 3, 4 \quad (7)$$

RM_i^{orange} oranges are needed for juice extraction processing RM_i^{juice} defined in (8) defined by the constant ρ representing the average yield of raw juice extracted per unit of oranges. Negligible or no mass loss during the pasteurization process is assumed.

$$RM_i^{juice} = \rho * RM_i^{orange} = RM_i^{past} \quad (8)$$

Distinctly RM_i^{past} represents the quantity of pasteurized juice required for outgoing product given that pasteurized juice is sent as a raw material to the bottling plant *as-is* (Pasteurized Not for Concentrate or PNFC); it is also used as an input raw material for the following processing step, concentration (Pasteurized For Concentrate or PFC), as shown in (9). It involves raw materials targeted at different destinations.

$$RM_i^{past} = RM_{if=NFC}^{past} + RM_{if=FC}^{past} \quad (9)$$

RM_i^{conct} is the raw material requirement by the bottling plant to produce From Concentrate Orange Juice (FCOJ). It is defined in (10) by the constant γ_p for concentration ratio based on the average level of concentration that can be achieve using the selected technology p .

$$RM_i^{conct} = \gamma_p \times RM_{if=FC}^{past} \quad (10)$$

Table A3 presents the two concentration levels that are reached by different equipment technologies being evaluated for the concentration process for the case study. It shows the quantity of single strength orange juice (i.e. with the natural concentration level of the juice $\sim 11^\circ Bx$) needed to produce a unit (measured in volume and weight) of multi-strength orange juice concentrate (i.e. orange juice that is concentrated to multiple times its Brix concentration, usually $44^\circ Bx$ and $66^\circ Bx$).

5.1.3. Bottling echelon

Within the Packaging/Bottling and Market echelons, there are a series of characteristics that are modelled for the case study. Looking at the demand side, there are two market regions r' France and Germany, this is denoted by the dotted line boxes in Fig. 3. Within each region, a single bottling plant is located and sized to satisfy the demand $D_{i,f,r',m}$ corresponding to a market of the 10 most populated cities m in each region r' denoted by the Distribution Centres (DC) boxes. A variable demand is allocated to each market within upper and lower limits. The demand to be covered by production capacity will be set as a decision variable. This allows the model to allocate the production output capacity to the most profitable and least environmentally damaging product types and markets (e.g. markets closer to a bottling plant may be more attractive). The lower limit for demand means that there is a minimum level to be satisfied while the upper limit represents an estimation of the market potential.

Four flows of bottled products from the bottling plant are connected to the market DC. The total capacity of the bottling plant is determined by the sum of the demands to be satisfied. These demands are divided by product type, based on the initial raw material sourcing i and on the fabrication steps it has gone through notably if it has been concentrated or not as indicated through f index.

More precisely, within the packaging/bottling plant, the input of raw materials coming from the market r' port of arrival is available in two forms, either single strength (or NFCOJ) form or multi-strength (or FCOJ) form for each raw material sourcing type i that is transformed using a given technology p . For the case of NFCOJ, no mass change is assumed, while for FCOJ, the addition of water serves to reconstitute the orange juice to its single strength form.

Mathematically these echelons involve RM_i^{bott} , i.e. the quantity of bottling juice required by the market DC; it is equal to the demand (11). The demand coverage is denoted by the integer decision variable $D_{i,f,r',m}$ that represent the number of final product units that are planned to be sold to the distribution centre in market m within the region r' of products type based on concentration f , where f can be either NFCOJ or FCOJ, as well as based on the type of raw materials used i .

$$RM_{i,f,r'}^{bott} = \sum_m D_{i,f,r',m}; \quad \forall r' \quad (11)$$

The demand is restricted by an upper and lower bound expressed in (12), these limits are viewed as the minimum acceptable market demand satisfaction and the maximum market demand saturation limits.

$$LLD_{i,f,r',m} \leq D_{i,f,r',m} \leq ULD_{i,f,r',m} \quad (12)$$

The demand is satisfied by the inputs coming from the pasteurization process as $RM_{if=NFCOJ}^{past}$ (13) and through the reconstitution step by adding water to the concentrated raw material $RM_{if=FCOJ}^{const}$ (14).

$$RM_{i,f,r'}^{bott} = RM_{if}^{past}, \quad \text{when } f = NFCOJ \quad (13)$$

$$RM_{i,f,r}^{bott} = \frac{1}{\gamma_p} RM_{i,f}^{conct} + \left(1 - \frac{1}{\gamma_p}\right) RM_{i,f}^{conct} \times Q_{water}, \quad \text{when } f = FCOJ \quad (14)$$

5.2. Operational and economic functions

5.2.1. Supplier echelon

In order to evaluate the economic performance, we need to determine the cost at each stage of the production process. The production cost of each type of product is dependent on the conditions and costs that are relative to each echelon of the network. A similar nomenclature is used to the one adopted for the demand and mass balance constraints: a super-index is used to denote the stage in processing of the materials (e.g. orange to raw juice to pasteurize and so on) and the sub-index is used to denote the sourcing of raw material and the processing steps.

The raw materials unit cost $RMUC_i^{orange}$ represents the cost that is necessary to produce 1 kg of oranges based on which agricultural practice category i was used (organic or conventional). It is estimated by dividing the sum of the annual supplier operating cost ASC_t of all orchards that use technologies t that are in the i technology category (see materials flows in Fig. 2) and divided by the sum total of capacity contracted **TotalCapacity_t** for agro practice t that are in the i label category:

$$RMUC_i^{orange} = \frac{\sum_t ASC_t}{\sum_t TotalCapacity_t}; \quad \forall t \in i \quad (15)$$

$$ASC_t = \sum_s OpCost_{r,s,t} \forall t \quad (16)$$

$$OpCost_{r,s,t} = LandArea_{r,s} \times \delta_{r,t}; \quad \forall r, s, t \quad (17)$$

The calculation for each product flow (i.e. organic and conventional) is allocated through (18) and (19)

$$RMUC_{i=org}^{orange} = \frac{\sum_t ASC_t}{TotalCapacity_t}; \quad \text{when } t = 1 \in i = Organic \subset T \quad (18)$$

$$RMUC_{i=conv}^{orange} = \frac{\sum_t ASC_t}{TotalCapacity_t}; \quad \text{when } t = 2, 3, 4 \in i = Conventional \subset T \quad (19)$$

5.2.2. Processing echelon

The raw material unit cost (RMUC) is used to compute the unit variable costs in the processing of the materials along the next processing steps. The processing of the materials is firstly carried out near the raw materials source that usually consists of **pasteurization**.

$$RMUC_{i,f=past}^{past} = \frac{AOC_{f=past,p}}{Cap_{f=past,p}^{OUT}} + RMUC_i^{orange}; \quad \forall i \quad (20)$$

$$AOC_{f=past,p} = \sum_e (\epsilon_{r,e} \times \lambda_{f,e,p} \times Cap_f^{IN}) \quad (21)$$

The capacity needed to operate (22) defines the capital investment (23):

$$Cap_{f=past}^{IN} = Cap_{f=past}^{OUT} \times \left(\frac{StdCap_{f,p}^{IN}}{StdCap_{f,p}^{OUT}} \right) \quad (22)$$

$$InvCost_f = StdCC_p \left(\frac{Cap_f^{OUT}}{StdCap_p} \right)^{3/5}; \quad \forall f \quad (23)$$

The next process is the **concentration process** for the case study. It is located at the same plant location than the pasteurization process. The concentration process consists of removing water through a selected concentration technology p from a list of candidates: evaporation, freezing, osmosis. Each technology has a different energy consumption profile defined by the type and quantity of energy resource used with a specific operation cost. The output of the system is constituted of two flows, organic and conventional FCOJ for the bottling plants. And its raw materials unit cost is defined in (24).

$$RMUC_{i,f=const}^{const} = \frac{AOC_{f=const,p}}{Cap_{f=const,p}^{OUT}} + (\gamma_p \times RMUC_i^{past}) \quad (24)$$

5.2.3. Bottling echelon

The final processing step is to bottle the product to be shipped. It is defined for the production flow of non-from concentrate orange juice in (25) and for the reconstitution process of from-concentrate orange juice in (26)

$$RMUC_{i,f=NFCOJ}^{bott} = BMC_p + RMUC_{i,f=past}^{past} \quad (25)$$

$$RMUC_{i,f=FCOJ}^{bott} = BMC_p + RMUC_{i,f=const}^{const} + \left[\left(1 - \frac{1}{\gamma_p}\right) \times \epsilon_{r',e=water} \times \lambda_{f,e,i} \right] \quad (26)$$

5.3. Environmental impact functions

The same basic modelling structure is used for the definition of the environmental impact functions. The environmental impact is focused on global warming potential as expressed in kgCO₂eq/kg.

For the **orchard production** stage the raw material unit environmental impact is defined by (27)–(29)

$$RMUEI_i^{orange} = \frac{\sum_t ASEI_t}{\sum_t TotalCapacity_t}; \quad \forall t | i \quad (27)$$

$$ASEI_t = \sum_s OpEI_{r,s,t}; \quad \forall t \quad (28)$$

$$OpEI_{r,s,t} = LandArea_{r,s,t} \times \psi_{r,t}; \quad \forall r, s, t \quad (29)$$

For the **pasteurization process** this is defined through (30)

$$RMUEI_{i,f=past}^{past} = \frac{AOEI_{f=past,p}}{Cap_{f=past,p}^{OUT}} + (\rho \times RMUEI_i^{orange}) \quad (30)$$

where the annual operating environmental impact is defined in (31)

$$AOEI_{f,p} = \sum_e (\varphi_{r,e} \times \lambda_{f,e,p} \times Cap_f^{IN}) \quad (31)$$

Concentration unit environmental impact is calculated in (32)

$$RMUEI_{i,f=const}^{const} = \frac{AOEI_{f=const,p}}{Cap_{f=const,p}^{OUT}} + (\gamma_p \times RMUEI_i^{past}) \quad (32)$$

And the two flows of **bottled** final product based on the concentration step criteria are defined in (33) and (34)

$$RMUEI_{i,f=NFCOJ}^{bott} = BMEI_p + RMUEI_{i,f=past}^{past} \quad (33)$$

$$RMUEI_{i,f=FCOJ}^{bott} = BMEI_p + RMUC_{i,f=const}^{const} + \left[\left(1 - \frac{1}{\gamma_p}\right) \times \phi_{r',e=water} \times \lambda_{f,e,i} \right] \quad (34)$$

5.4. Transportation functions

The transportation activities involved through the supply chain have an economic and environmental cost. The four intermediate product types, i.e., pasteurized single strength (NFCOJ) organic and conventional orange juice, and concentrated multiple strength (FCOJ) organic and conventional orange juice differ from their production cost, related to their operations but share the same transportation cost in terms of kilogram kilometer (kg km) per mode of transport. These intermediate products are transported in bulk by different modes and route; for our case study, transport is limited to sea freight transport from the port of departure of the region r selected, with two arrival port destinations. These ports service two main market regions, mainly France and Germany, the two largest consumers of fruit juice in Europe. Within each market region, a set of markets (10 in the case study) made up of the most populated cities (10 in the case study). This configuration is shown in Table A7 where the economic cost from one location to its destination is denoted by $\theta_{A \rightarrow B}$ where A is the current location and B is the destination for each echelon connection in the network in \$/kg km; while $\psi_{A \rightarrow B}$ represents the environmental impact of each transport trajectory measured in kg of CO₂ eq/kg km (as abovementioned).

Table A7 presents the values that are used for the case study for the sea freight transport concerning economic and environmental impact constants used to measure the performance of the transportation activities from $r \rightarrow r'$. Tables A3–A6 present in more detail the values for the two other main transportation trajectories that are included in the case study model, mainly port of arrival to bottling plant and bottling plant to market city.

The general mathematical representation of the transport cost is through the multiplication of the intermediate product quantity to be transported $Q_{A \rightarrow B}$ that is a measurement in kg of material equivalent to the weight needed to produce one unit of the final product and the standard cost θ_k from location A to B in \$/kg km.

$$TUC_{i,f,m,r}^{A \rightarrow B} = Q_{i,f,m,r}^{A \rightarrow B} \times \theta^{A \rightarrow B}; A \text{ initial location and } B \text{ final location} \quad (35)$$

For the environmental impact the coefficient involves the standard emission ψ_k from location A to B in kgCO₂eq/kg km.

$$TUE_{i,f,m,r}^{A \rightarrow B} = Q_{i,f,m,r}^{A \rightarrow B} \times \psi^{A \rightarrow B}; A \text{ initial location and } B \text{ final location} \quad (36)$$

5.5. Objective functions

In order to evaluate the performance of the supply chain network, different criteria are developed. Initially one needs to empirically or through an “objectives and preferences study” choose a set of criteria of interest, which reflect the economic and environmental performance of the SC. The model considers four possible objectives NPV, GWP, average VUC and I .

5.5.1. NPV and investment

One of the most widely used KPIs is the Net Present Value (NPV) of a project. The advantage of this indicator is that it looks at the long-term plan taking into consideration the effect of time. Additionally, it considers the operational and the fixed capital cost within a single framework in contrast to single facets of a project such as Sales Revenue, Project Cost, among others KPIs. It is defined in its objective function form as follows

$$\max NPV = -I + \sum_{j=1}^{nj} \frac{[V_j - C_j - A_j] * [1 - \alpha] + A_j}{(1 + ir)^j} \quad (37)$$

Investment I is calculated by summing the equipment cost and multiplying by the Lang factor (f_L) for the type of production system

$$I = f_L \sum_f InvCost_f \quad (38)$$

Sales revenue (V_j) in a period is the product of sales price by the demand and satisfies:

$$V_j = \sum_i \sum_f \sum_m \sum_{r'} (SP_{i,f,m,r'} \times D_{i,f,m,r'}); \quad \forall i, f, m, r', j \quad (39)$$

The Sales Price (SP) is calculated in function of the variable unit cost $VUC_{i,f,m,r'}$, a sales margin M_i .

$$SP_{i,f,m} = VUC_{i,f,m,r'} * M_i; \quad \forall i, f, m, r' \quad (40)$$

The Cost C is defined by sum of the products planned to be produced defined by the product of the demand coverage (D) for each product at each market by its unit Variable Unit Cost (VUC)

$$C_j = \sum_i \sum_f \sum_m \sum_{r'} (VUC_{i,f,m,r'} \times D_{i,f,m,r'}); \quad \forall i, f, m, r' \quad (41)$$

The variable unit cost is defined by the sum of all the operational cost incurred to produce and deliver each final product to each market. In general it considers raw materials, processing and bottling costs, and transport variable costs for each product based on the type of product type and the market it is sent to (for the case study 80 VUCs are estimated in total: 2 labels (i) * 2 process routes (f) * 10 markets (m) * 2 regions (r'))

$$VUC_{i,f,m,r'} = \sum_i \sum_f \sum_m \sum_{r'} (RMO_{i,f,m,r'}^{bottl} + TUC_{i,f,m,r'}^{r \rightarrow r'} + TUC_{i,f,m,r'}^{r' \rightarrow b} + TUC_{i,f,m,r'}^{b \rightarrow m}); \quad \forall i, f, m, r' \quad (42)$$

The investment, previously defined, is used to estimate the amortization A by dividing I by n periods of operation (i.e. strength line method).

$$A_j = \frac{I}{n} \quad (43)$$

For the case study, a time period n equal to 10 years, an interest rate of 12% and a tax rate α equal to 0.322 and $f_L = 2.02$ for Orange Juice Concentration equipment (Saravacos & Maroulis, 2007) are considered.

5.5.2. GWP

Simultaneously environmental impact measurements are also developed for each optimization instance. The proposed approach takes into account the GWP indicator. It is defined as the sum of the environmental impact output per unit given the type of product and market to which it is transported to (i.e. each of the 20 market destinations demanding the 4 types of products, 80 unique **UnitEnvImp**) times the number of product produced to cover each demands

$$\min \text{Global GWP} = \sum_i \sum_f \sum_m \sum_{r'} (\text{UnitEnvImp}_{i,f,m,r'} \times D_{i,f,m,r'}); \quad \forall i, f, m, r' \quad (44)$$

$$\text{UnitEnvImp}_{i,f,m} = \sum_i \sum_m (RME_{i,f,m}^{bottl} + TUE_{i,f,m,r'}^{r \rightarrow r'} + TUE_{i,f,m,r'}^{r' \rightarrow b} + TUE_{i,f,m,r'}^{b \rightarrow m}); \quad \forall i, f, m, r' \quad (45)$$

5.5.3. Average variable unit cost

The sum of the product of each **VUC** times the quantity that is produced (D) for each type of product given i label, f fabrication steps and marketed to m in region r' divided by the sum of all

the production output planned for all products to all markets gives the average variable cost.

$$AVUC = \frac{\sum_i \sum_f \sum_m \sum_{r'} (VUC_{i,f,m,r'} \times D_{i,f,m,r'})}{\sum_i \sum_f \sum_m \sum_{r'} D_{i,f,m,r'}}; \quad \forall i, f, m, r' \quad (46)$$

6. Case study

The GSCND approach provides special attention to materials and information flows and other logistics issues, some operations are aggregated into higher-level black-box operations in order to manage the SC scope. Indeed, compared to the study performed by Beccali, Cellura, Iudicello, and Mistretta (2010), that is used as a reference for the case study design, transportation operations are included in more detail than in Beccali et al. (2010) life cycle assessment study alone.

The case study considers the 1 L of bottled orange juice as the functional unit in its 4 variations (based on labelling). The essential oil and other by-products are excluded from the scope.

In contrast to the approach used in Beccali et al. (2010), the model proposed here addresses many important supply chain design issues. First, two types of raw materials (i.e. organically and conventionally grown orange fruit) based on the agricultural practices applied (i.e. use of agrochemicals), are considered (see

top of Fig. 1). These two materials flows are segregated throughout the product life cycle in order to evaluate a differentiated pricing policy based on this quality attribute. Besides, the type of agro practices that can be selected during production, this can range in the level of intensity with which agrochemicals are used. Four levels, ranging from organic agro practice to intensive are considered. The organic practice uses no agrochemicals. In return, the production yield per hectare is very low but is assumed as the only type of production that allows the use of organic eco-labels. The intensive case, and all other in-between levels, use fertilizers and pesticides in order to achieve better production yields but are prohibited to be marketed as organic.

In Beccali et al. (2010), the primary process consisted in the sorting, cleaning and extraction operations, that are aggregated in the pasteurization process in our case study. The detailed study of these operations could be considered in future work but was excluded to delimit a more manageable scope in terms of data collection. Pasteurization process, concentration and bottling are considered here as the three main process steps that are the focus of the SCND problem formulation. These steps and the relationship to their relative supply chain echelons are presented Fig. 1.

The Focal Company that manages a globally distributed orange juice supply chain needs to select a project to increase capacity. The potential market demand is assumed to be known. The main

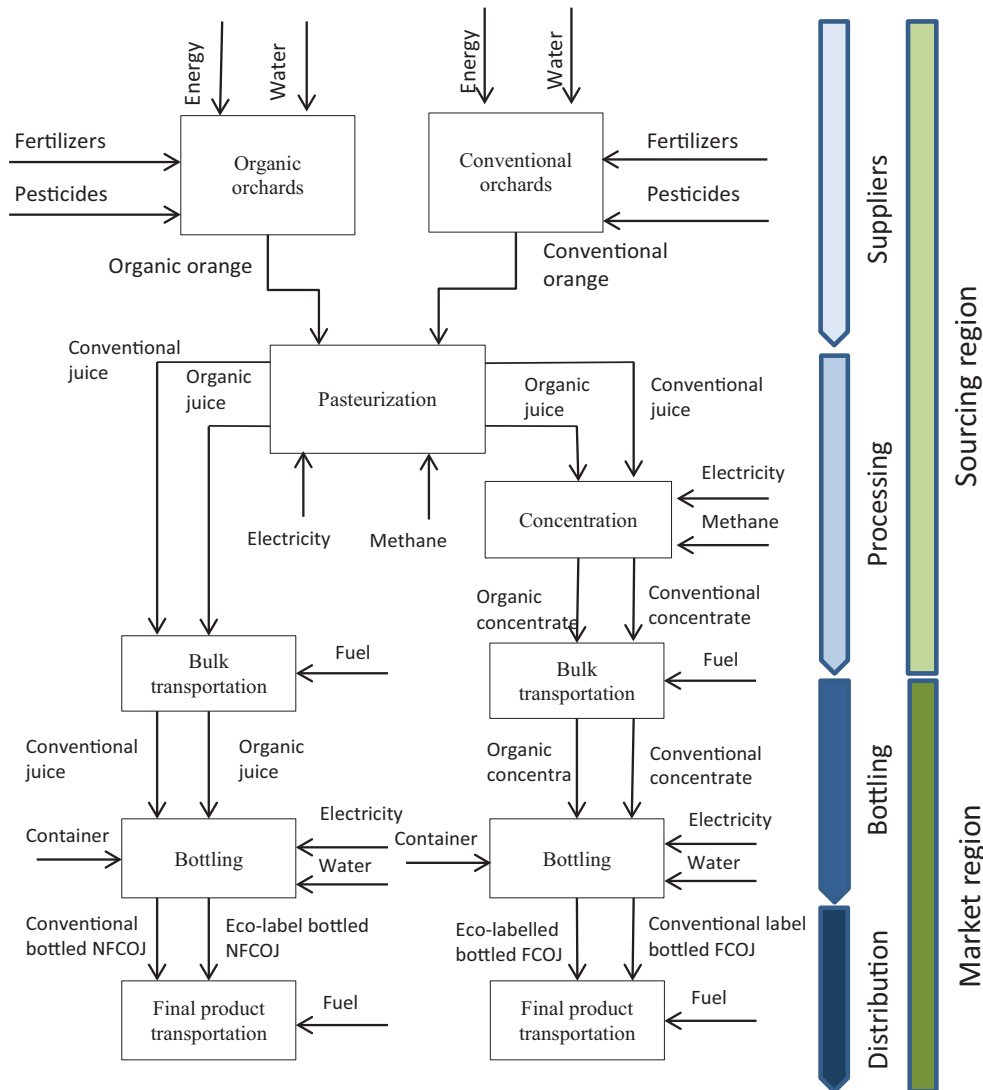

Fig. 1. Sample agro-food supply chain network diagram.

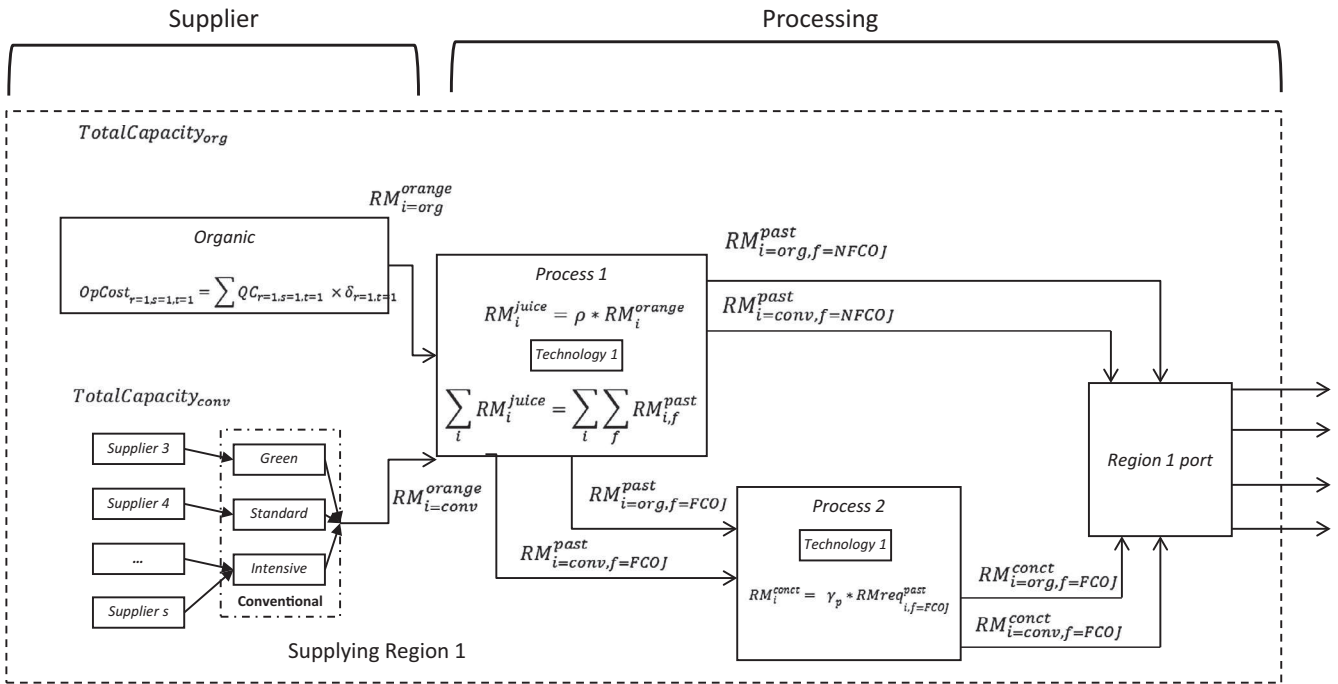

Fig. 2. Supplier and processing plant materials flow diagram.

assumptions are the following ones: (1) Two potential raw material supplying regions are considered, i.e., Mexico and Brazil, to meet raw material requirements; (2) Only one region has to be selected, from which a set of suppliers are contracted in order to satisfy the capacity level as required by the demand and the quality of oranges; (3) The oranges will be processed at a plant located near the supplier. A selection of technologies and capacities has to be carried out to best satisfy market needs; (4) The final products are of four types, combining the label attribute (*organic* labelled and conventionally labelled) and the processing attribute (from concentrate and not from concentrate); (5) The market target is composed of ten principal cities in two countries (France and Germany); (6) A set of 6 potential sites to locate a bottling/distribution site for each country is considered.

The parameter values used for this case study are presented the Appendices. The overall dimension of the case study problem is indicated in Table 2.

Fig. 4 illustrates the Sequential Optimization Scheme that consists of a two-stage solution strategy. In all the optimization runs, two or three criteria are optimized. In all the cases, the environmental component is always factored in through Global Warming Potential indicator optimization while the economic viewpoint varies targeting fixed capital cost and operational expenditures.

In the first stage, **Scenario 1 (Sc1)** uses a customer-centred optimization in order to find the best Average Variable Unit Cost (AVUC), while minimizing GWP. AVUC is defined as the cost to produce and deliver a product before adding profit (Sales Price is calculated based on AVUC). For this purpose, Net Present Value (NPV) is set to equal zero, this is to say, the Focal Company preference of profitability is neglected. Let us recall that NPV is a measurement of the difference between the present value of forecasted cash inflows and outflows of a project. It is used to analyse the profitability of a project considering time. This baseline scenario (Sc1) is used to obtain an estimate of the Sales Price that will then be used in the second stage of the approach.

The **second stage (Sc2 to Sc4)** is based on a profit strategy reflecting the focal company's preference. The Sales Price (SP) of each product is defined by a profit margin over the Average Vari-

able Unit Cost (AVUC) values found in Sc1: a value of 25% is considered in the simulation scenario for illustration purpose. It must be highlighted that the current gross profit margin reported in the business literature for orange juice is at 9–60% and depends on multiple factors (Neves, Trombin, Lopes, Kalaki, & Milan, 2011). The 25% markup was selected as a representative average value to be used in the case study but could easily be modified without contradicting the essence of the analysis. In this second stage, the SP obtained in Sc1 is used as a fixed parameter that indirectly represents the customers' preferences. To reflect the company's preference as the other principal stakeholder, different indicators are evaluated. These strategies explore a combination of Key Performance Indicators from a business perspective.

Table 3 is a summary of the different scenarios evaluated under the Sequential Optimization Scheme.

6.1. Scenario 1: customer-oriented model

Scenario 1 is formulated from the point of view of the customer. The objective is to minimize simultaneously GWP and CP, in order to reflect the consumer preference for environmentally sound and low cost products. For this purpose, CP is computed by constraining NPV to be equal to zero in order to find breakeven point. It serves two main objectives; the former consists to favour the customers' prerogative before any other stakeholders', the latter gives a reference value for the price that can be competitive with market prices.

Fig. 5 illustrates the layout and materials flows of the supply chain. The proposed legend will be used throughout. For this purpose, the symbols are presented in detail for their first occurrence in this manuscript so that the reader can be familiar with such representation.

Supplying regions: The supplying regions, Mexico and Brazil, and their sets of suppliers are represented by two types of symbols, i.e. triangles and circles respectively. The triangle denotes the selection of the region if filled, a two-digit number denotes the technologies selected. The first digit refers to the pasteurization process and the second to the concentration process. Let us recall

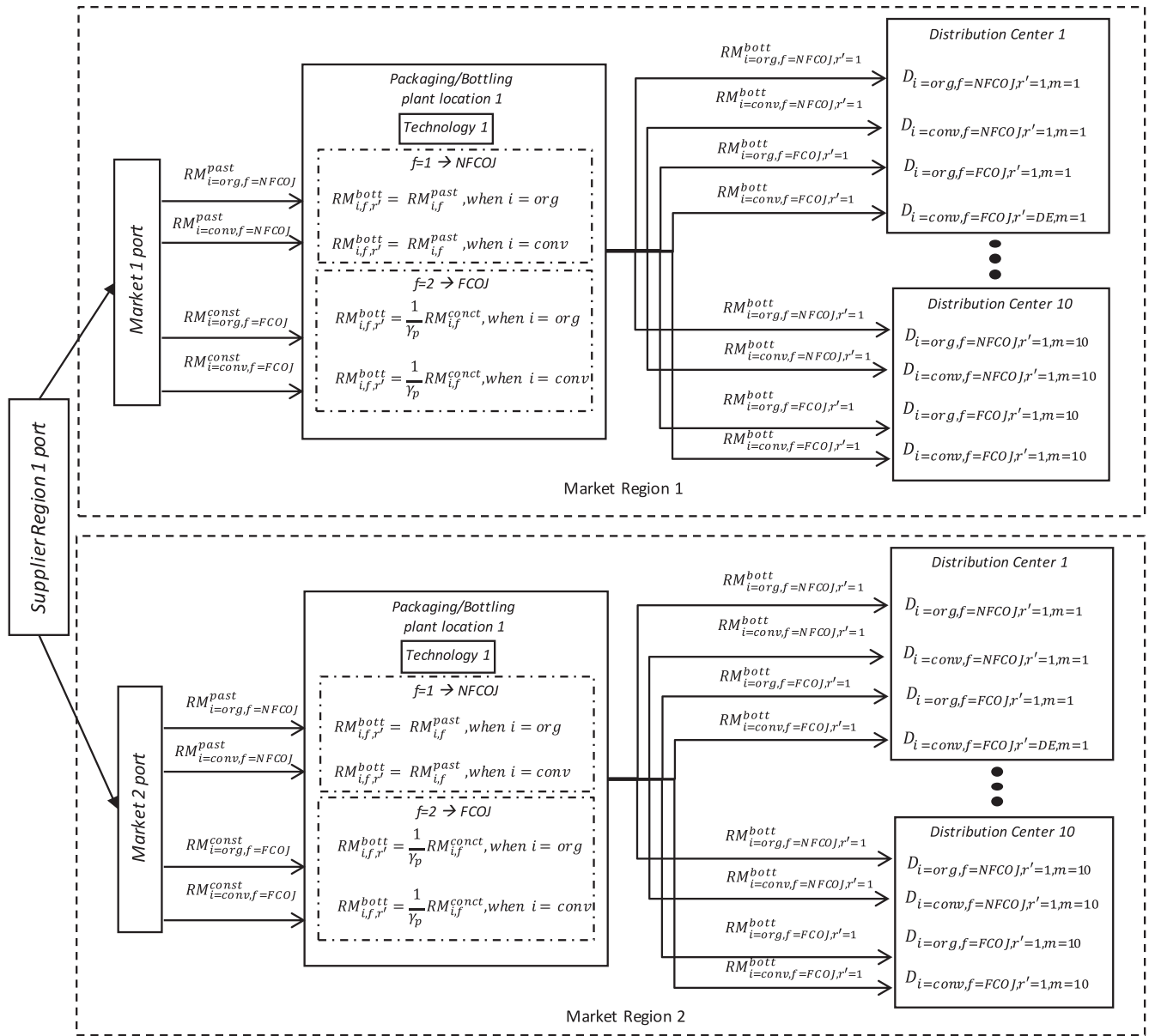

Fig. 3. Bottling and market materials requirement flow diagram.

Table 2
Case study model characteristics.

Objective functions	3
Decision variables	147
Dependent variables	1846
Parameters	348

that each process can be carried out by a set of technologies, each technology can also be operated by different operational conditions, i.e. energy and water requirements, amounts of raw materials, thus leading to different output flows. In the example case, the Mexico region is selected. Technology 2 (PEF) for pasteurization and technology 1 (Multi-effect evaporator) for concentration process are selected at the initial processing site. In addition, a set of 4 suppliers producing by organic agro practice, 2 using quasi-organic and 2 with intensive agro practice are selected to meet raw materials requirements. The circles symbolize the suppliers

that can be selected. The circles are colour coded (see code table in Fig. 5), representing the type of agro practices assigned to selected suppliers.

Pie charts are then proposed to represent the nature of the raw materials that are exported from the supplier region to the customer region to be bottled. The upper two (i.e. NFC – DE and FC – DE) represent the amounts of raw materials that flow, from Mexico to Germany; the information is separated based on processing steps applied to the raw materials (i.e. non concentrated (NFC), concentrated (FC)) and the pie segments symbolize the raw materials used through the colour code (see code table in Fig. 5). In addition, reference values are provided for each slice of the pie in kilograms of raw material. In Scenario 1, conventionally produced raw materials in both concentrated and non-concentrated forms are mainly sent to Germany (DE). The lower two pie charts on the left hand corner represent the flow from Mexico to France (FR). The flow of organic and conventionally sourced raw materials is mixed.

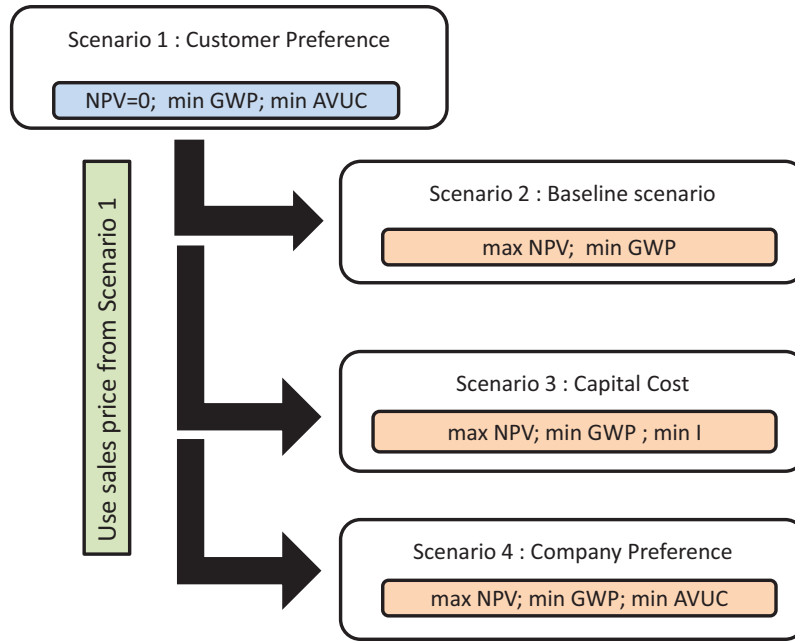

Fig. 4. Sequential optimization scheme.

Table 3
Summary of the results for Scenarios 1–4.

Scenario	Model	Description & Key results
Scenario 1 (Sc1)	$\min[GWP(x,y), AVUC(x,y)]$ $s.t. g_i(x,y,z) \leq b_i$ $NPV(x,y,z) = 0$ $y \in \{0,1\}^m, x \in \mathbb{Z}^n, z \in \mathbb{R}$ $SalesPrice_i = VUC_i * (1 * Margin), \forall i \in I$ <i>where Margin = 25%</i>	Fixing NPV to zero to find minimum Variable Unit Cost at lowest GWP output in order to reflect the customers' preference; also used to estimate a base Sales Price to be used in other Scenarios
Scenario 2 (Sc2)	$\min[-NPV(x,y), GWP(x,y)]$ $s.t. g_i(x,y) \leq b_i$ $y \in \{0,1\}^m, x \in \mathbb{Z}^n$ <i>SalesPrice_i(from Scenario 1)</i>	Integrating fixed Sales Price for all products to the value found in Scenario 1 while maximizing NPV and minimizing global GWP. Used as a baseline model
Scenario 3 (Sc3)	$\min[-NPV(x,y), GWP(x,y), I(x,y)]$ $s.t. g_i(x,y) \leq b_i$ $y \in \{0,1\}^m, x \in \mathbb{Z}^n$ <i>SalesPrice_i(from Scenario 1)</i>	Adding the Investment cost as a minimization objective function to consider a second economic criterion to favour project initiation phase
Scenario 4 (Sc4)	$\min[-NPV(x,y), GWP(x,y), AVUC(x,y)]$ $s.t. g_i(x,y) \leq b_i$ $y \in \{0,1\}^m, x \in \mathbb{Z}^n$ <i>SalesPrice_i(from Scenario 1)</i>	Sc 3 produces the best trade-off results yet Poor performing solutions compared to scenarios 2 and 3

Customer regions: Concerning the market regions, France and Germany, four symbols are involved. The red² circles indicate the location of a market city. Two pie charts are allocated for each city, i.e., green for organic label demand and blue for conventional product. Each pie symbolizes the fraction of the market that is covered with the optimized values for capacity and allocations of final product to market. The coverage is a little over half for organic products and roughly a third for conventional products in both countries. In addition, each country has six alternative locations for the bottling plant symbolized by the squares (see Fig. 1 in Appendix A). Going back to Fig. 5, the filled square is the selected bottling site location; it contains a digit representing the technology selected for the bottling process. In France, the bottling location is location 4 and technology 2 (glass bottle) is assigned. Germany bottling plant is also located in site 2 and technology 1 (PET bottle) is involved.

² For interpretation of colour in Figs. 5 and 9, the reader is referred to the web version of this article.

Table 4 presents some Key Performance Indicators and some Key Environmental Performance Indicators of interest.

Fig. 6 presents a summary of the sales price values found through Sc1 that are used for Sc2 through Sc4. In addition a reference value is presented from an LCA case study developed by Beccali, Cellura, Iudicello, and Mistretta (2009). The reference values are lower because they do not include bottling and final transportation costs; but they do serve to validate that the behaviour between NFC and FC for Sc1, i.e. FC being much more expensive than NFC, is consistent with the related literature.

6.2. Scenario 2: Environmentally conscious company perspective

Scenario 2 (Sc2) is formulated from the point of view of the environmentally friendly company. The objective functions are to maximize NPV and minimize GWP. This approach has been the most widely used strategy in the relevant literature and serves as a baseline model.

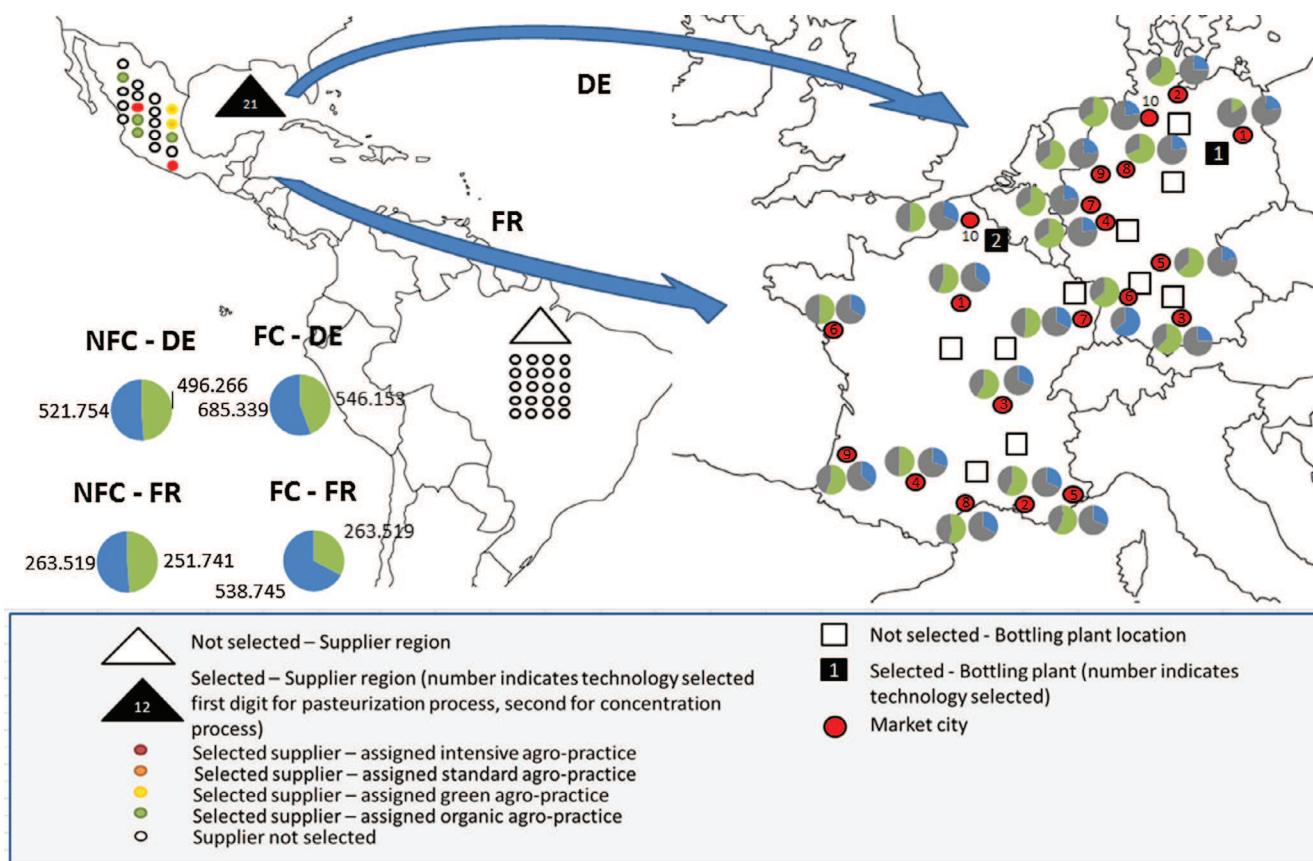

Fig. 5. Scenario 1: Supply Chain Network design and materials flow.

Table 4
KPI and KEPI summary for Scenario 1.

NPV (\$)	GWP (kgCO ₂ eq)	Average GWP/L (kgCO ₂ eq/L)	AVUC (\$/L)	Investment (\$)
0	2 011 882	0.6121	0.6490	2,174,893

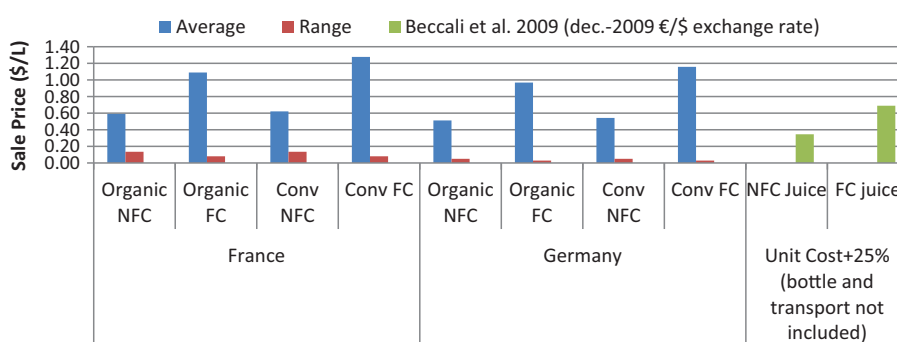

Fig. 6. Scenario 1: Sales price AVERAGE summary and reference value from Beccali et al. (2009).

Sc2 uses a fixed sales price strategy (FSPS). In other words, the values for sales prices found in Sc1 optimization are used as fixed parameters in Sc2. The objective of this approach is to evaluate the effectiveness of integrating the competing preferences of the main stakeholders, mainly the consumer and the company. A secondary objective is to evaluate the antagonistic behaviour resulting from the well-established NPV vs. GWP optimization approach with one centred on the consumer.

6.3. Scenario 3: Focal company Perspective with investment consideration

Scenario 3 (Sc3) is formulated considering the Investment cost (I) taken by the company to carry out the project. The objective functions are to maximize NPV while minimizing GWP and I. The investment, as defined in Objective Functions section, is the total capital investment for each of the three main processing steps

(pasteurization, concentration and bottling) multiplied by the corresponding *Lang factor* (Saravacos & Maroulis, 2007). The consideration of investment as an objective function gives an additional weight to economically performing SC network designs, favouring risk-aversion.

6.4. Scenario 4: Focal company Perspective with variable unit cost consideration

Scenario 4 (Sc4) takes a different approach to guaranty maximum performance for the focal company, by maximizing NPV and minimizing GWP and Variable Unit Cost (AVUC). Given that Sales Price (SP) is fixed based on the Sc1 values, minimizing AVUC helps insure that the solutions that are found during the optimization process are the best in terms of operational costs, improving profit.

7. Results and discussion

7.1. Results

Fig. 7 presents a summary of the different scenarios evaluated under the Fixed Price Strategy (FPS) to the GSCND problem - illustrating the four objectives that were evaluated. Overall, these cases support the view that: (1) even with the restrictive Fixed Pricing Strategy (FPS) - in all cases profitable project alternatives are found i.e. positive NPV values for all scenarios. (2) The different scenarios provide insight on the sensitivity of the model to different objective function definitions under the FPS. (3) The best performing strategies are Sc2 and Sc3. Sc2 provides the lowest GWP value for the M-TOPSIS solution at 1.85 M kgCO₂eq outperforming Sc3 by a very low margin (Sc3 has a GWP of 1.96 M kgCO₂eq). Both scenarios exhibit very similar values for NPV with 1.92 M\$ and 2.14 M\$ for Sc2 and Sc3 respectively (Sc3 holding a slight edge). The decision to select an optimization strategy is not easy to make.

To better understand what is driving the better performance of some scenarios over others we present more details on Sc3 and make comparisons to Sc2 its closest alternative solution. The outputs obtained from Sc3 in terms of NPV and GWP is shown in Fig. 8. The M-TOPSIS solution found in Sc2 as well as the set of Pareto optimal and M-TOPSIS solution for Sc3 are displayed. Compared to the results for Sc2 that form a single quasi-continuous curve, Fig. 8 shows two curves that form the Pareto front, one in

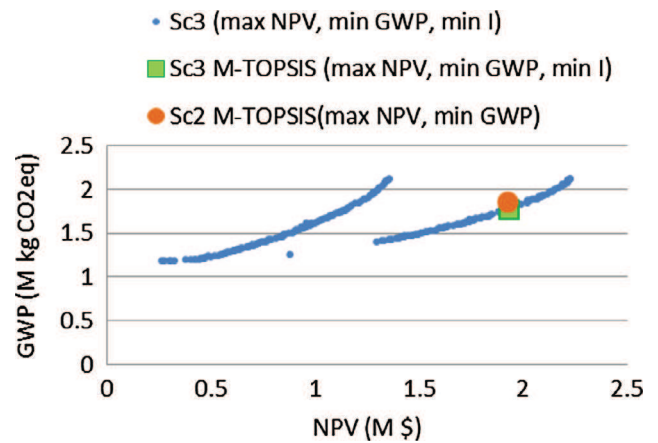

Fig. 8. NPV and GWP 2D Pareto front output for Sc3 with M-TOPSIS solution and Sc2 m-topsis solution.

the lower NPV range of ~0.2 to 1.3 M\$ and a second around 1.3 to 2.3 M\$. The M-TOPSIS solution falls in the latter region.

The formation of two groups of solutions is mainly due to one variable: concentration technology selection. Fig. 9 shows the Pareto front output in terms of NPV and GWP per litre of orange juice coloured by the technology selected. It must be emphasized that this figure (it will also be the same for the following ones) only visualizes 2 dimensions out of the 3 that are being optimized for simplicity and clarity. The red square represents the solutions that selected Multiple-effect evaporator concentration technology while the blue triangles are solutions involving freeze concentration technology. A strong relationship between the NPV and GWP/L values exists as exhibited by the Pareto front: solutions with multiple-effect evaporator technology have lower NPV solutions than those with freeze concentration technology. In terms of GWP/L they are roughly in the same range, given that they both have a similar energy consumption range based on the case study and exhibit "U" shaped patterns reflecting the influence of Demand coverage variation.

In terms of AVUC shown in Fig. 10, a slight improvement can be observed in terms of M-TOPSIS top solutions. The top ranked M-TOPSIS solution is located in the same vicinity as that of Scenario 2 in terms of NPV, while it is lower (better) in terms of AVUC criterion. Furthermore, a similar pattern to that shown in Fig. 10

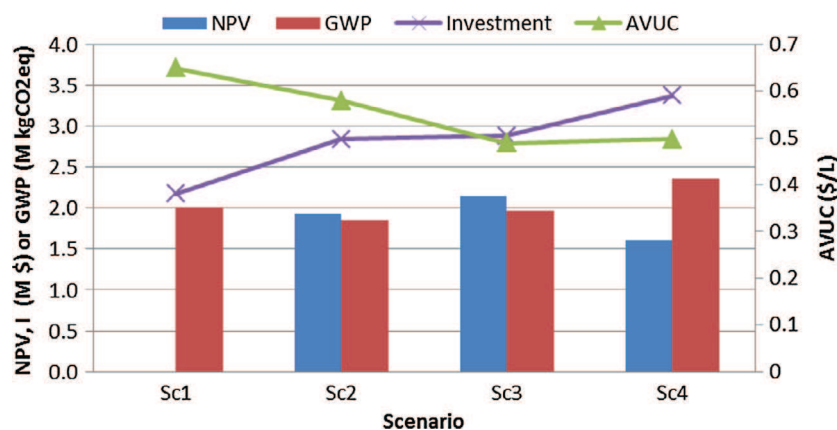

Fig. 7. Sequential Optimization Scheme: M-TOPSIS top ranked solutions outcome summary.

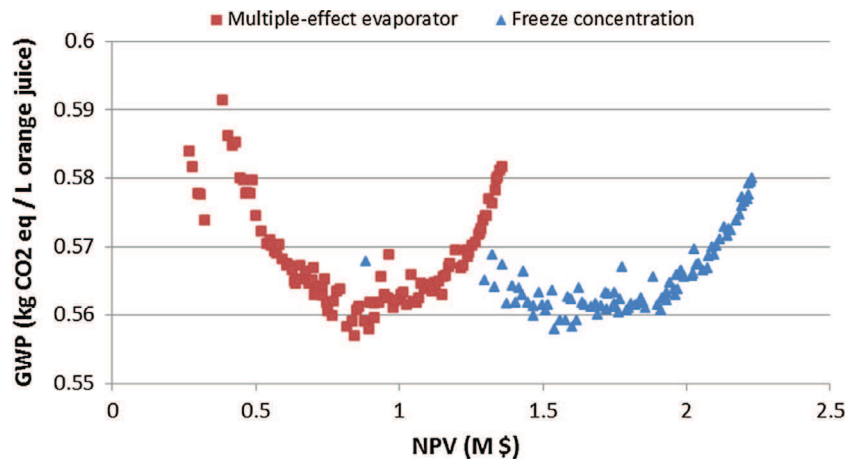

Fig. 9. NPV and GWP 2D Pareto front output for Sc3 with Concentration Technology Selection variable.

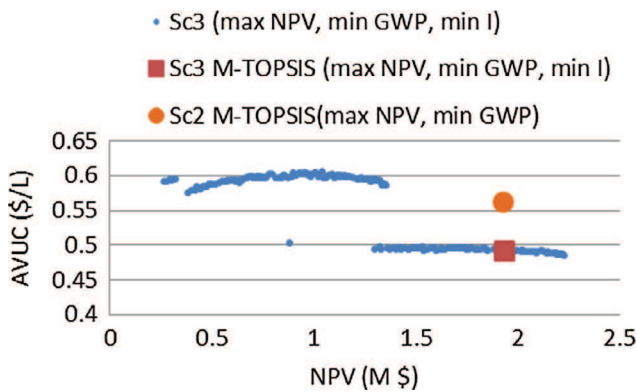

Fig. 10. AVUC and NPV 2D Pareto front output for Sc3 with M-TOPSIS solution and Sc2 M-TOPSIS solution.

where the concentration technology selected has an important influence on the outcome is seen. This is to say that AVUC has two main clusters of solution points. One cluster that ranges below

~1.3 M \$ NPV and the other above this threshold. This difference in outcomes is related to the capital and operational cost related to each concentration technology. This highlights the importance of the technology selection variable in terms of both criteria.

The relation between NPV and Investment (see Fig. 11) is roughly linear and similar to the trend already observed in Sc2. A computation of the internal rate of return (IRR) corresponding to each solution is also carried out. **Internal rate of return (IRR)** is the interest rate at which the net present value of all the cash flows (both positive and negative) from a project or investment equals zero. Internal rate of return is used to evaluate the attractiveness of a project or investment. If the IRR of a new project exceeds a company's required rate of return, that project is desirable. If IRR falls below the required rate of return, the project should be rejected.

IRR is shown in Fig. 11, it has a slight curvature but does not have a peak to aid the decision making process. It grows basically linearly while NPV grows. The IRR for the M-TOPSIS solution is roughly 27% which is above the industry standard that ranges from 20 to 25% (Brookes, 2007). Both optimization strategies (i.e. Sc2 and Sc3) produce solutions in the same search space, and the solu-

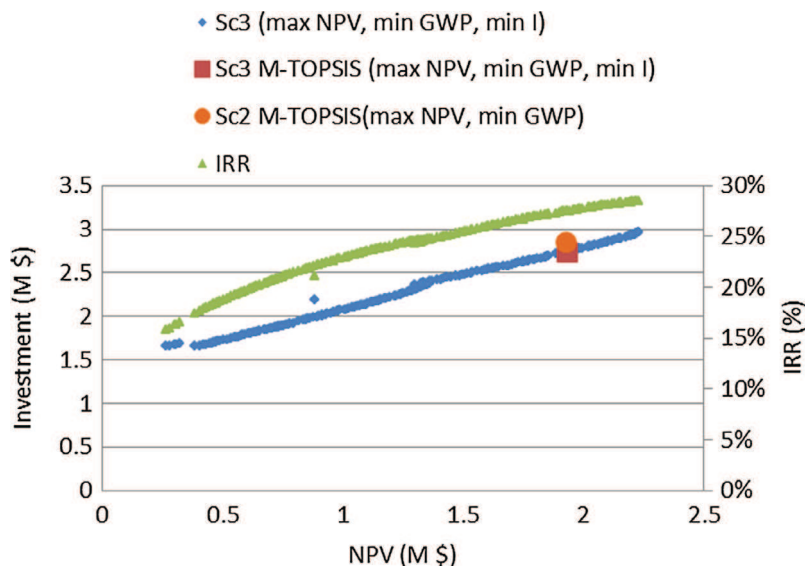

Fig. 11. Investment and NPV 2D Pareto front output for Sc3 with M-TOPSIS solution and Sc2 M-TOPSIS solution.

tions proposed by the M-TOPSIS method are in the same vicinity. It is important to note that although Sc2 and Sc3 have similar outcomes, Sc3 is the best performing one yet.

7.2. Discussion

More general conclusions can be made compared to those reported in the dedicated literature. Let us consider Scenario 3 (Sc3), using the top ranked trade-off solutions found through the modelling and optimization framework. Firstly, the average variable unit cost found ranges from just below to 0.5 \$/L to just above 0.6 \$/L of juice, including bottling and transportation cost, while the work in (Beccali et al., 2009) presents an average of 0.2 \$/L for concentrated juice and 0.4 \$/L in bulk presentation without bottling and little information on distribution transportation cost included. With relation to the GWP, if we take a per litre equivalent of the total GWP output of the M-TOPSIS solution in Fig. 8 it is roughly 0.56 kg CO₂eq/L while (Doublet et al., 2013) presents in its case study a value of 0.67 kgCO₂eq/L, a significant improvement.

The main focus of this paper is to introduce this modelling and optimization framework to the processed food industry supply chain network design problem. Indeed many different applications and analysis can be made to this base strategy. The work presented is the base method for a wider scope research project that takes this framework to analyse different strategies and scenarios beyond the ones presented here. These range from evaluating different objectives in the objective functions set, to pricing strategies within the unit cost and sales revenue calculations, this is to say at different levels of the framework.

Furthermore, there are many aspects of food supply chain that were not taken into account. Some key issues are: (1) the inclusion of risk and uncertainty of many elements ranging from weather and catastrophic events at the agricultural level, to market price pressures on sales, market shares modelled, and fuel and input costs; (2) secondly, the dynamic nature of the systems was assumed to be stable, while non-linear behaviours of orchards yields through time, as well as, other time-dependent characteristics of food systems were out of the scope of this study; (3) finally the use of other strategies, such as recycling within closed-loop supply chain systems. A good example of this would be to take into account the bottle recycling policies followed in France and Germany.

From a technical stand point the use of other modelling and solution strategies may benefit the proposed framework in terms of finding solutions more efficiently. In particular other solution methods such as epsilon constraint (De-León Almaraz et al., 2013) and goal programming could provide a different set of advantages and challenges that should be explored. The proposal of this paper is not a comparative study on solving methods, but rather the formulation of a unique green supply chain network design problem that integrates various points into a single problem formulation. It would be of interest to evaluate more effective and efficient approaches to framing and solving the issues that are discussed in this paper, mainly, the inclusion of technology selection within the framework of a agrofood supply chain network design problem, the evaluation of the effect of eco-labelling and consumer preference alternatives in the SC design process, and finally the focus on materials flows that are restricted given the attribute of organic or non-organic raw materials use.

These are all issues that are currently being studied within the wider agrofood supply chain communities and indeed within the research group that developed the framework presented here.

8. Conclusion

This modelling framework presented in this paper has been developed to guide the modeller on the key issues that have to be incorporated for GSCN modelling and design process, and provides examples on how to overcome situations that occur frequently in agro-food systems. The orange juice case study serves as an illustration case for the modelling and optimization strategies presented and the possible application. A set of scenarios is now explored to find the best solution strategy for the case study instance taking into account the various stakeholders of the supply chain.

A multiobjective optimization approach is proposed to take into account multiple conflicting objectives from the different stakeholders that can be considered, mainly the consumer, the focal company and the natural environment. The criteria that are suggested are measured through medium and long term metrics: (1) such as capital investment and net present value to evaluate the economic feasibility of the project; (2) average unit operational cost that is an important factor to fix the unit sales price in many cases, thus it is an important economic factor for the consumer and for the retailer; (3) the global warming potential measuring the equivalent carbon emission throughout the product life cycle in order to gauge the environmental performance of the operations and processes that are involved in the production and distribution of the intermediate and final products.

Through this set of objective functions, a decomposition of the components that describe the interdependencies and relationships each echelon and its related decisions have on each other were presented. By proposing such an approach, a larger scope was used in order to incorporate special characteristics of the system, such as the use of eco-labelling and product concentration and reconstitution (for transport purposes), present in many modern food production systems.

The orange juice case study illustrates the effect and importance of using such an approach. It provides insight on the usefulness this approach has compared to conventional mono-objective and Focal Company centred approaches, this is to say production systems that mainly focus on profit as the principal objective and only take into account the preferences of the coordinating firm, which is generally the owner of the brand, equipment, intellectual property and capital, thus limiting the objectives and preferences of other actors concerning environment and society. It corroborates the findings that have been seen in life cycle assessments in the past, and extends by providing a framework to incorporate more sensitivity to the some of the most important environmental hotspots in the processed food life cycle, e.g. packaging/bottling and transportation/distribution. By shedding a light on these important issues, and providing a means to integrate them in the strategic decisions framework, the work presented provides a reasonable roadmap towards more inclusive and wider scope approach to green supply chain network design in the processed food industry, and in particular in the promotion of greener and more sustainable designs.

Acknowledgement

We would like to thank the partial financial support of the Mexican government through CONACYT – Mexico and SEP – Mexico.

Appendix A

Table A1

Average output, cost and environmental impact per agro practice and region summary table.

Parameter	Agro practice (t)	Mexico ($r = 1$) (Consejo Citricola Poblano, 2004)	Brazil ($r = 2$) (Knudsen et al., 2011; Oelofse et al., 2010)
Output ($\beta_{r,t}$; kg/ha/yr)	Organic (1)	5000	18,000
	Quasi-organic (2)	8000	18,660
	Standard (3)	15,000	19,320
	Intensive (4)	25,000	20,000
Cost ($\delta_{r,t}$; \$/ha/yr)	Organic (1)	284	1139
	Quasi-organic (2)	552	1065
	Standard (3)	820	991
	Intensive (4)	1096	914
GWP ($\varphi_{r,t}$; kg CO ₂ eq/ha/yr)	Organic (1)	633	1512
	Quasi-organic (2)	1307	1752
	Standard (3)	1981	1992
	Intensive (4)	2675	2240

Table A2

Land size per supplying orchard from both Mexico and Brazil regions.

Supplier (s)	1	2	3	4	5	6	7	8	9	10
Mexico; $r = 1$ ($\omega_{r,s}$; ha)	100	150	320	12	14	19	28	256	35	365
Brazil, $r = 2$ ($\omega_{r,s}$; ha)	35	49	64	26	15	23	44	41	440	923
Supplier (s)	11	12	13	14	15	16	17	18	19	20
Mexico; $r = 1$ ($\omega_{r,s}$; ha)	350	420	490	560	630	320	12	14	19	28
Brazil, $r = 2$ ($\omega_{r,s}$; ha)	1060	53	13	66	17	67	23	29	21	14

Table A3

Single strength to multi-strength ($>11^\circ$ Brix) concentration coefficients.

Concentration	γ_p (L single strength OJ/L FCOJ)	γ_p (kg single strength OJ/kg FCOJ)
44 °Brix _c	4.27	3.57
66 °Brix _c	7.08	5.35

Based on Amador (2011).

Table A4

Cost and environmental impact emissions by country region.

Region	$\varepsilon_{r,e}$			$\varphi_{r,e}$		
	$e = \text{electricity}$	$e = \text{gas}$	$e = \text{water}$	$e = \text{electricity}$	$e = \text{gas}$	$e = \text{water}$
(r, r')	(\$/kW h)	(\$/kW h)	(\$/kg)	(kgCO ₂ eq/kW h)	(kgCO ₂ eq/kW h)	(kgCO ₂ eq/kg)
France	5.92E-02	4.78E-02	4.56E-02	9.21E-02	6.98E-02	2.44E-06
Germany	1.08E-01	5.36E-02	5.36E-02	6.77E-01	6.98E-02	2.44E-06
Mexico	1.09E-01	2.74E-02	6.98E-02	5.73E-01	6.98E-02	2.44E-06
Brazil	1.03E-01	2.53E-02	6.98E-02	2.26E-01	6.98E-02	2.44E-06

Source:

- Gas cost for France and Germany taken from Eurostat website retrieved 11-03-2014 link (<http://epp.eurostat.ec.europa.eu/tgm/table.do?tab=table&init=1&pluin=0&language=en&pcode=ten00112>).
- Gas cost for Mexico based on Section 3.5 in Secretaría de Energía and Mexico (2012).
- Gas cost for Brazil source of data (Mathias & Cecchi, 2009).
- Electricity data for all from International Energy Agency, Energy Prices & Taxes – Quarterly Statistics, Fourth quarter 2009, Part II Section D, Table 21 and Part III, Section B, Table 18 and 2008.
- Water data for Mexico and Brazil from The International Benchmarking Network for Water and Sanitation Utilities retrieved 16-04-2014 (<http://www.ib-net.org/en/production/?action=country>).
- Water data for France and Germany from Global Water Intelligence retrieved 16-04-2014 (<http://www.globalwaterintel.com/archive/12/9/market-profile/global-water-tariffs-continuE-upward-trend.html>).
- GWP emissions taken from Santoyo-Castelazo, Gujba, and Azapagic (2011) and the SimaPro EcolInvent 2.2 (May 2010) database.

Table A5

Pasteurization and concentration technology characterization summary table.

Parameter	Unit	Pasteurization (f = past)		Concentration (f = conct)		
		HHP (p = 1)	PEF (p = 2)	Multieffects evaporator (p = 1)	Freeze (p = 2)	Reverse (p = 3)
StdCap _p ^{IN}	(kg/yr)	1.62E+07	3.75E+07	1.28E+08	5.63E+07	3.75E+07
StdCap _p ^{OUT}	(kg/yr)	1.59E+07	3.68E+07	2.38E+07	1.58E+07	1.05E+07
Concentration	(°Brix)	–	–	66	44	44
e = gas	(kW h/kg)	–	–	8.41E–04	–	–
e = electricity	(kW h/kg)	1.71E–01	2.78E–02	–	9.33E–03	1.18E–03
e = water	(kgwater/kg)	–	–	6.6	–	–
StdCC _{fp}	\$ (2010)	1,875,000	2,500,000	1,272,006	2,750,712	2,303,523

Source:
– Pasteurization data from Balda, Aparicio, and Samson (2012), Pereira and Vicente (2010), and Toepfl, Mathys, Heinz, and Knorr (2006) and Hiperbaric Co. Equipment catalog retrieved 03/2014 from web page http://www.hiperbaric.com/media/uploads/equipos/documentos/Hiperbaric_Range_2015_ENG_opt_internet1.pdf.
– Concentration data from Bomben, Bruin, Thijssen, and Merson (1973).

Table A6

Bottling technology characterization summary table.

p	Technology	BMC _p \$/L bottling juice	$\lambda_{f=NFCOJ,e=water,p}$ L water/L bottled juice	$\lambda_{f=FCOJ,e=water,p}$ L water/L bottled juice	$\lambda_{f,e=electricity,p}$ kW h/L bottling juice	stdCC _p \$ (2010)	StdCap _p ^{OUT} L/per year
1	PET bottle	0.02747	0.66924	0.66924	0.66924	275,000	3,170,409
2	Glass bottle	0.1025	1.37957	1.37957	1.37957	275,000	3,170,409
3	Aseptic carton	0.07714	0.39039	0.39039	0.39039	430,000	3,170,409

Source: Spitzley et al. (1997) actualized to 2010.

Table A7

Economic and environmental impact cost for transportation from departure to arrival ports.

Port of arrival	$\theta^{r \rightarrow r}$ (\$/kg km) (Brown, Spreen, & Lee, 2004)		r ^r EI (kg CO ₂ eq/kg km) (SimaPro Eco-invent database)		Distance (km)	
	Mexico	Brazil	Mexico	Brazil	Mexico	Brazil
Nantes (FR)	0.08171	0.08945	0.08498	0.09303	10,623	11,628
Rotterdam (NL)	0.08839	0.09613	0.09193	0.09998	11,491	12,497

References

- Ahumada, O., & Villalobos, J. R. (2009). Application of planning models in the agri-food supply chain: A review. *European Journal of Operational Research*, 196, 1–20.
- Altıparmak, F., Gen, M., Lin, L., & Karaoglan, I. (2009). A steady-state genetic algorithm for multi-product supply chain network design. *Computers & Industrial Engineering*, Design and Management of Production Systems, 56, 521–537. <http://dx.doi.org/10.1016/j.cie.2007.05.012>.
- Amador, J. R. (2011). *Procedures for analysis of citrus products* (6th ed.).
- Amin, S. H., & Zhang, G. (2013). A multi-objective facility location model for closed-loop supply chain network under uncertain demand and return. *Applied Mathematical Modelling*, 37, 4165–4176. <http://dx.doi.org/10.1016/j.apm.2012.09.039>.
- Apaiah, R. K., & Hendrix, E. M. T. (2005). Design of a supply chain network for pea-based novel protein foods. *Journal of Food Engineering*, 70, 383–391. <http://dx.doi.org/10.1016/j.jfoodeng.2004.02.043>.
- Arkeman, Y., & Jong, K. D. (2010). Development of multiobjective genetic algorithms for agri-food supply chain design by considering global climate change [WWW Document]. URL <http://repository.ipb.ac.id/handle/123456789/41683> Accessed 10.1.13.
- Balda, F. P., Aparicio, B. V., & Samson, C. T. (2012). Industrial high pressure processing of foods: Review of evolution and emerging trends. *Journal of Food Science and Engineering*, 2, 543–549.
- Beccali, M., Cellura, M., Iudicello, M., & Mistretta, M. (2009). Resource consumption and environmental impacts of the agrofood sector: Life cycle assessment of Italian citrus-based products. *Environmental Management*, 43, 707–724. <http://dx.doi.org/10.1007/s00267-008-9251-y>.
- Beccali, M., Cellura, M., Iudicello, M., & Mistretta, M. (2010). Life cycle assessment of Italian citrus-based products. Sensitivity analysis and improvement scenarios. *Journal of Environmental Management*, 91, 1415–1428. <http://dx.doi.org/10.1016/j.jenvman.2010.02.028>.
- Bloemhof, J. M., van der Vorst, J. G. A. J., Bastl, M., & Allaoui, H. (2015). Sustainability assessment of food chain logistics. *International Journal of Logistics Research and Applications*, 18, 101–117. <http://dx.doi.org/10.1080/13675567.2015.1015508>.
- Bomben, J. L., Bruin, S., Thijssen, H. A., & Merson, R. L. (1973). Aroma recovery and retention in concentration and drying of foods. *Advances in Food Research*, 20, 1–111.
- Brindley, C., & Oxborrow, L. (2014). Aligning the sustainable supply chain to green marketing needs: A case study. *Industrial Marketing Management*, 43, 45–55. <http://dx.doi.org/10.1016/j.indmarman.2013.08.003>.
- Brookes, G. (2007). Economic impact assessment of the way in which the EU novel foods regulatory approval procedures affect the EU food sector. In *Brief. pap. confed. food drink ind. Eur. Union CIAA platf. ingred. Eur. PIE.*
- Brown, M. G., Spreen, T. H., & Lee, J.-Y. (2004). Impacts on US prices of reducing orange juice tariffs in major world markets. *Journal of Food Distribution Research*, 35, 26–33.
- Cerutti, A. K., Bruun, S., Beccaro, G. L., & Bounous, G. (2011). A review of studies applying environmental impact assessment methods on fruit production systems. *Journal of Environmental Management*, 92, 2277–2286. <http://dx.doi.org/10.1016/j.jenvman.2011.04.018>.
- Chan, H. K., He, H., & Wang, W. Y. C. (2012). Green marketing and its impact on supply chain management in industrial markets. *Industrial Marketing Management*, 41, 557–562. <http://dx.doi.org/10.1016/j.indmarman.2012.04.002>.
- Collette, Y., & Siarry, P. (2003). *Multiobjective optimization: principles and case studies*. Springer Science & Business Media.
- Consejo Citrícola Poblano, A. C. (2004). Plan rector del sistema producto naranja: Diagnostico para el estado de Puebla.
- Cortez, P. (2014). *Modern Optimization with R, Use R!* Springer International Publishing, Chem.
- Coskun, S., Ozgur, L., Polat, O., & Gungor, A. (2016). A model proposal for green supply chain network design based on consumer segmentation. *Journal of Cleaner Production, Special Volume: Improved Resource Efficiency and Cascading Utilisation of Renewable Materials*, 110, 149–157. <http://dx.doi.org/10.1016/j.jclepro.2015.02.063>.
- Costa, A., Celano, G., Fichera, S., & Trovato, E. (2010). A new efficient encoding/decoding procedure for the design of a supply chain network with genetic algorithms. *Computers & Industrial Engineering*, 59, 986–999. <http://dx.doi.org/10.1016/j.cie.2010.09.011>.
- Curti-Díaz, S. A., Diaz-Zorrilla, U., Loredano-Salazar, X., Sandoval Rincon, J. A., Pastrana Aponte, L., & Rodriguez Cuevas, M. (1998). Manual de producción de naranja para Veracruz y Tabasco.
- Czarnecki, J. J. (2011). *The future of food eco-labeling: Organic, carbon footprint, and environmental life-cycle analysis* (SSRN Scholarly Paper No. ID 1645860). Rochester, NY: Social Science Research Network.

- Deb, K., Pratap, A., Agarwal, S., & Meyarivan, T. (2002). A fast and elitist multiobjective genetic algorithm: NSGA-II. *IEEE Transactions on Evolutionary Computation*, 6, 182–197. <http://dx.doi.org/10.1109/4235.996017>.
- De-León Almaraz, S., Azzaro-Pantel, C., Montastruc, L., Pibouleau, L., & Senties, O. B. (2013). Assessment of mono and multi-objective optimization to design a hydrogen supply chain. *International Journal of Hydrogen Energy*, 38, 14121–14145. <http://dx.doi.org/10.1016/j.ijhydene.2013.07.059>.
- Dietz, A., Azzaro-Pantel, C., Pibouleau, L., & Domenech, S. (2006). Multiobjective optimization for multiproduct batch plant design under economic and environmental considerations. *Computers & Chemical Engineering*, 30, 599–613. <http://dx.doi.org/10.1016/j.compchemeng.2005.10.017>.
- Doublet, G., Jungbluth, N., Flury, K., Stucki, M., & Schori, S. (2013). Life cycle assessment of orange juice. SENSE-Harmonised Environmental Sustainability in the European food and drink chain, Seventh Framework Programme: Project no. 288974. Funded by EC. Deliverable D 2.1 ESU-services Ltd.: Zürich.
- Eraslana, S. (2015). A decision making method via TOPSIS on soft sets. *Journal of New Results in Science*, 8, 57–71.
- Eskandarpour, M., Dejax, P., Miemczyk, J., & Péton, O. (2015). Sustainable supply chain network design: An optimization-oriented review. *Omega*, 54, 11–32. <http://dx.doi.org/10.1016/j.omega.2015.01.006>.
- Farahani, R. Z., Rezapour, S., Drezner, T., & Fallah, S. (2014). Competitive supply chain network design: An overview of classifications, models, solution techniques and applications. *Omega*, 45, 92–118. <http://dx.doi.org/10.1016/j.omega.2013.08.006>.
- Garcia, D. J., & You, F. (2015). Supply chain design and optimization: Challenges and opportunities. *Computers & Chemical Engineering*. <http://dx.doi.org/10.1016/j.compchemeng.2015.03.015>.
- Gomez, A., Pibouleau, L., Azzaro-Pantel, C., Domenech, S., Latgé, C., & Haubensack, D. (2010). Multiobjective genetic algorithm strategies for electricity production from generation IV nuclear technology. *Energy Conversion and Management*, 51, 859–871.
- Guillén-Gosálbez, G., & Grossmann, I. E. (2009). Optimal design and planning of sustainable chemical supply chains under uncertainty. *AIChE Journal*, 55, 99–121. <http://dx.doi.org/10.1002/aic.11662>.
- Hugo, A., & Pistikopoulos, E. (2004). Environmentally conscious process planning under uncertainty. In C. A. Floudas & R. Agrawal (Eds.), *Sixth international conference on foundations of computer aided process design*. Princeton: CACHE Corporation.
- Joliet, O., Saadé, M., & Crettaz, P. (2010). *Analyse du cycle de vie: Comprendre et réaliser un écobilan*. Lausanne: Presses polytechniques et universitaires romandes.
- Kim, G., Park, C. S., & Yoon, K. P. (1997). Identifying investment opportunities for advanced manufacturing systems with comparative-integrated performance measurement. *International Journal of Production Economics*, 50, 23–33. [http://dx.doi.org/10.1016/S0925-5273\(97\)00014-5](http://dx.doi.org/10.1016/S0925-5273(97)00014-5).
- Knudsen, M. T., de Almeida, G. F., Langer, V., de Abreu, L. S., & Halberg, N. (2011). Environmental assessment of organic juice imported to Denmark: A case study on oranges (*Citrus sinensis*) from Brazil. *Organic Agriculture*, 1, 167–185. <http://dx.doi.org/10.1007/s13165-011-0014-3>.
- Mathias, M. C., & Cecchi, J. C. (2009). Indústria de gas natural en Brasil: Pasado, Presente y Futuro.
- Miranda-Ackerman, M. A. (2015). Optimisation multi-objectif pour la gestion et la conception d'une chaîne logistique verte: Application au cas de la filière agroalimentaire du jus d'orange [WWW Document]. <<http://www.theses.fr>>. URL <<http://www.theses.fr/s139158>> Accessed 01.22.16.
- Miranda-Ackerman, M. A., Fernández-Lambert, G., Azzaro-Pantel, C., & Aguilar-Lasserre, A. A. (2014). A multi-objective modelling and optimization framework for operations management of a fresh fruit supply chain: A case study on a Mexican Lime Company. In J. Valadi & P. Siarry (Eds.), *Applications of metaheuristics in process engineering* (pp. 373–394). Springer International Publishing.
- Mohammed, A., & Wang, Q. (2017). The fuzzy multi-objective distribution planner for a green meat supply chain. *International Journal of Production Economics*, 184, 47–58. <http://dx.doi.org/10.1016/j.ijpe.2016.11.016>.
- Neves, M. F., Trombin, V. G., Lopes, F. F., Kalaki, R., & Milan, P. (2011). Breakdown of the price of orange juice on the retail market. In *The orange juice business* (pp. 97–113). Wageningen Academic Publishers.
- Oelofse, M., Høgh-Jensen, H., Abreu, L. S., Almeida, G. F., Hui, Q. Y., Sultan, T., & de Neergaard, A. (2010). Certified organic agriculture in China and Brazil: Market accessibility and outcomes following adoption. *Ecological Economics*, 69, 1785–1793. <http://dx.doi.org/10.1016/j.ecolecon.2010.04.016>.
- Pereira, R. N., & Vicente, A. A. (2010). Environmental impact of novel thermal and non-thermal technologies in food processing. *Food Research International, Climate Change and Food Science*, 43, 1936–1943. <http://dx.doi.org/10.1016/j.foodres.2009.09.013>.
- Ren, L., Zhang, Y., Wang, Y., & Sun, Z. (2010). Comparative analysis of a novel M-TOPSIS method and TOPSIS. *Applied Mathematics Research Express*. <http://dx.doi.org/10.1093/amrx/abm005>.
- Rousseau, S., & Vranken, L. (2013). Green market expansion by reducing information asymmetries: Evidence for labeled organic food products. *Food Policy*, 40, 31–43. <http://dx.doi.org/10.1016/j.foodpol.2013.01.006>.
- Roy, P., Nei, D., Orikasa, T., Xu, Q., Okadome, H., Nakamura, N., & Shiina, T. (2009). A review of life cycle assessment (LCA) on some food products. *Journal of Food Engineering*, 90, 1–10.
- Ruiz de Maya, S., López-López, I., & Munuera, J. L. (2011). Organic food consumption in Europe: International segmentation based on value system differences. *Ecological Economics*, 70, 1767–1775. <http://dx.doi.org/10.1016/j.ecolecon.2011.04.019>.
- Santoyo-Castelazo, E., Gujba, H., & Azapagic, A. (2011). Life cycle assessment of electricity generation in Mexico. *Energy*, 36, 1488–1499. <http://dx.doi.org/10.1016/j.energy.2011.01.018>.
- Saravacos, G., & Maroulis, Z. (2007). *Food plant economics, Food science and technology*. CRC Press.
- Secretaría de Energía, Mexico (2012). *Prospectiva del mercado de gas natural 2012–2026: Mexico*. Mexico: Secretaría de Energía de Mexico.
- Seuring, S., & Muller, M. (2008). From a literature review to a conceptual framework for sustainable supply chain management. *Journal of Cleaner Production*, 16, 1699–1710.
- Sharma, V. K., Chandna, P., & Bhardwaj, A. (2017). Green supply chain management related performance indicators in agro industry: A review. *Journal of Cleaner Production*, 141, 1194–1208. <http://dx.doi.org/10.1016/j.jclepro.2016.09.103>.
- Sonesson, U. G., Lorentzon, K., Andersson, A., Barr, U.-K., Bertilsson, J., Borch, E., ... Wall, H. (2016). Paths to a sustainable food sector: Integrated design and LCA of future food supply chains: The case of pork production in Sweden. *International Journal of Life Cycle Assessment*, 21, 664–676. <http://dx.doi.org/10.1007/s11367-015-0969-5>.
- Spitzley, D. V., Keoleian, G. A., & McDaniel, J. S. (1997). *Life cycle design of milk and juice packaging*. US Environmental Protection Agency, National Risk Management Research Laboratory.
- Srivastava, S. K. (2007). Green supply-chain management: A state-of-the-art literature review. *International Journal of Management Reviews*, 9, 53–80.
- Toepfl, S., Mathys, A., Heinz, V., & Knorr, D. (2006). Review: Potential of high hydrostatic pressure and pulsed electric fields for energy efficient and environmentally friendly food processing. *Food Reviews International*, 22, 405–423. <http://dx.doi.org/10.1080/87559120600865164>.
- Tukker, A., & Jansen, B. (2006). Environmental impacts of products. *Journal of Industrial Ecology*, 10, 159–182.
- Vermeulen, S. J., Campbell, B. M., & Ingram, J. S. I. (2012). Climate change and food systems. *Annual Review of Environment and Resources*, 37, 195–222. <http://dx.doi.org/10.1146/annurev-environ-020411-130608>.
- Yang, X.-S. (2008). *Introduction to Mathematical Optimization: From Linear Programming to Metaheuristics*. Cambridge International Science Publishing.
- Yeh, W.-C., & Chuang, M.-C. (2011). Using multi-objective genetic algorithm for partner selection in green supply chain problems. *Expert Systems with Applications*, 38, 4244–4253. <http://dx.doi.org/10.1016/j.eswa.2010.09.091>.
- Zanakis, S. H., Solomon, A., Wishart, N., & Dubliss, S. (1998). Multi-attribute decision making: A simulation comparison of select methods. *European Journal of Operational Research*, 107, 507–529. [http://dx.doi.org/10.1016/S0377-2217\(97\)00147-1](http://dx.doi.org/10.1016/S0377-2217(97)00147-1).
- Zhang, Q., Shah, N., Wassick, J., Helling, R., & van Egerschot, P. (2014). Sustainable supply chain optimisation: An industrial case study. *Computers & Industrial Engineering*, 74, 68–83. <http://dx.doi.org/10.1016/j.cie.2014.05.002>.