



HAL
open science

Parameter identification and model updating in the context of nonlinear mechanical behaviors using a unified formulation of the modified Constitutive Relation Error concept

Basile Marchand, Ludovic Chamoin, Christian Rey

► **To cite this version:**

Basile Marchand, Ludovic Chamoin, Christian Rey. Parameter identification and model updating in the context of nonlinear mechanical behaviors using a unified formulation of the modified Constitutive Relation Error concept. *Computer Methods in Applied Mechanics and Engineering*, 2019, 345, pp.1094-1113. 10.1016/j.cma.2018.09.008 . hal-01879908

HAL Id: hal-01879908

<https://hal.science/hal-01879908>

Submitted on 21 Oct 2021

HAL is a multi-disciplinary open access archive for the deposit and dissemination of scientific research documents, whether they are published or not. The documents may come from teaching and research institutions in France or abroad, or from public or private research centers.

L'archive ouverte pluridisciplinaire **HAL**, est destinée au dépôt et à la diffusion de documents scientifiques de niveau recherche, publiés ou non, émanant des établissements d'enseignement et de recherche français ou étrangers, des laboratoires publics ou privés.



Distributed under a Creative Commons Attribution - NonCommercial 4.0 International License

Parameter identification and model updating in the context of nonlinear mechanical behaviors using a unified formulation of the modified Constitutive Relation Error concept

Basile Marchand^a, Ludovic Chamoin^{a,*}, Christian Rey^b

^a*LMT (ENS Cachan/CNRS/Paris-Saclay University),
61 Avenue du Président Wilson, 94235 Cachan Cedex, France*

^b*Safran Tech,
1 rue Geneviève Aubé, CS 80112, 78772 Magny-les-Hameaux, France*

Abstract

The motivation of this work is to propose a general methodology to deal with complex nonlinear mechanical behaviors in the context of identification and model updating problems. We follow here the principle of the modified Constitutive Relation Error that is an energy-based functional suited to the solution of inverse problems, and originally used in the context of elasticity and elastodynamics problems with potentially highly corrupted experimental data. In the paper, we develop and analyze an extended formulation of the modified Constitutive Relation Error functional in order to deal with a wide class of nonlinear mechanical behaviors. The general idea in the construction of the functional is to ensure a strong mechanical content by referring to the thermodynamical framework. In addition, a dedicated numerical process sharing similarities with the LaTIn method is proposed in order to allow effective inversion with reasonable computational cost. The performance of the developed procedure is analyzed on 2D elastic-damage and 3D elasto-visco-plastic cases.

Keywords: Validation, Inverse problems, Modified Constitutive Relation Error, Nonlinear mechanical models, Damage identification

*Corresponding author

Email address: chamoin@ens-paris-saclay.fr (Ludovic Chamoin)

1. Introduction

Nowadays a main limitation in the numerical simulation of structural mechanics problems comes from the setting of input model parameters. Indeed, the last two decades have seen major advances in terms of : (i) computing infrastructure, with the increasing use of supercomputers as illustrated in Figure 1 ; (ii) computational methods, involving strongly parallelized algorithms such as direct parallel solvers, domain decomposition methods, or multigrid methods. With this large amount of numerical resources, a wide variety of complex problems can now be solved efficiently. Nevertheless, in order to

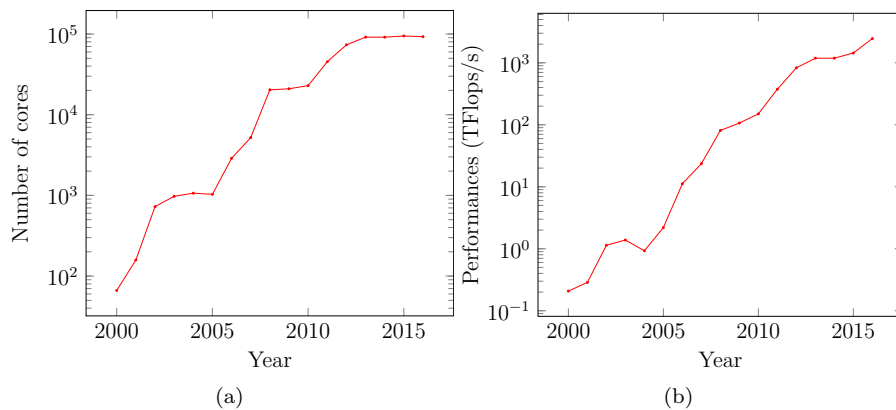

Figure 1: Evolution of computational resources during these last 16 years (mean over the five first French clusters in the TOP500 Supercomputer list [54])

perform meaningful simulations (i.e. with quantitative output information) considering complex mechanical behaviors, a key point is the accurate choice of the values of input parameters in such models. The present work enters in this framework.

In order to perform numerical simulations which are relevant representations of a physical system, a classical procedure is to fit model input parameters with respect to available observations on the system. The identification of these parameters is then performed solving an inverse problem that exploits a combination of model and experimental data. In the context of inverse problems, there is a wide range of approaches in the literature. We can basically distinguish two classes of approaches: (i) deterministic ones usually based on the minimization of a functional with the addition of a regularization term [14, 10]; (ii) stochastic ones in which the inverse problem is formulated using the Bayesian framework and therefore described in terms of probability densities [55, 34, 57]. In the remainder of the paper, we focus on the first class and we deal with a specific tool referred to as the modified Constitutive Relation Error (mCRE).

The mCRE was initially introduced in [41]. It is based on the constitutive

relation error (CRE) concept which makes use of duality and convexity properties when formulating material constitutive laws [50, 17, 29]. This latter concept has been widely used over the last 40 years for the verification of computational mechanics models, i.e. the derivation of a posteriori error estimates in order to assess the quality of finite element calculations (see [42, 39] for an overview). During the 90s, the CRE concept was extended to model identification/updating and originated the mCRE method. First introduced for linear dynamics models [41, 19, 44, 9], this method was later successfully used in many calibration applications including defects [13], uncertain measurements, behaviors, or loadings [23, 43, 25, 16], or even corrupted measurements [2, 26]. It was also used in the context of full-field measurements [5, 27, 52, 8], or in conjunction with reduced order modeling [12, 15] and data assimilation tools [48]. After initial studies in which measurements were basically included as additional admissibility constraints in the CRE concept, the more flexible and effective mCRE strategy was developed. This strategy consists in relaxing constraints on measurements and other uncertain data, proposing a general framework in which reliable theoretical and experimental information (equilibrium, sensor position,...) is favored to define admissibility spaces, and residual on complementary information (material behavior, sensor values,...) is measured; a nice review on the mCRE philosophy is given in [33]. The mCRE strategy acts in an iterative two-steps algorithm, in which optimal admissible fields are first computed (with respect to both model and observations), before minimizing the obtained mCRE functional with respect to model parameters. The use of mCRE presents interesting advantages for model identification or updating [53]: (i) it has excellent capabilities to localize structural defects spatially; (ii) it naturally contains a regularization procedure due to the employed hierarchical updating; (iii) it is very robust with respect to noisy measurements or corrupted data; (iv) it has good convexity properties inducing the identification of a global minimum.

In the present work, we wish to extend the mCRE concept for parameter identification and model updating in the context of nonlinear material behaviors encountered in structural mechanics applications. Such complex behaviors have now become usual when dealing with inverse problems [20, 21, 22, 46, 6]. Using CRE-type identification tools, some works proposed pioneering methodologies [3, 46, 7] but these are specific and functionals which are introduced are tuned to the considered problem, with empirical considerations. Here, we wish to define a general approach for the definition of the mCRE functional and the associated minimization process to be used. For that purpose, we adopt the approach that extends the original CRE concept to complex nonlinear models proposed in [40, 45, 38] in the context of model verification. Issued from a sound thermodynamical background, this extension is based on the fact that a large class of material behaviors (with so-called *standard formulation* [31]) can be described in terms of state equations and evolution laws which are defined by means of convex and dual (in the Legendre-Fenchel sense) potentials; these are usually related to free energy and dissipation. Therefore, a suitable

CRE measure defined by Legendre-Fenchel residuals and sharing similarities with the so-called *symmetrized Bregman divergence* [18] can be defined from these potentials; it is in practice applied to an admissible solution satisfying kinematic constraints and balance equations. We propose to use this measure in the mCRE functional, thus performing a natural transition between CRE and mCRE for nonlinear models. Even though it applies to all material behaviors with standard formulation, the proposed methodology is here detailed in the context of (visco-)plasticity with possible softening (isotropic damage).

A second advance in the paper is the introduction of a specific numerical strategy, taking in account the structure of the constructed nonlinear mCRE functional, in order to perform inversion in an effective way and with a reasonable CPU cost. This strategy has a strong physical background and is closely related to the LaTin method [35, 37, 11]; it allows to perform the solution for a large variety of material behaviors and is dedicated to multi-resolution with restart procedure, that is the reuse of a computed LaTin space-time solution as the initialization of another iterative LaTin procedure with other material or loading parameters.

The overall methodology which is proposed in this paper is illustrated on two numerical experiments in order to assess its performance. In particular, a real-case application involving a 3D elasto-visco-plastic structure is proposed.

The paper is organized as follows: Section 2 is devoted to the introduction of the reference nonlinear model considered throughout the work, as well as to the presentation of the original mCRE concept applied to linear problems; in Section 3 we present in details the proposed general formulation of the mCRE functional, which is applicable to both linear and nonlinear inverse problems in structural mechanics; an associated numerical strategy that enables to lead the inversion process in an effective way is developed in Section 4; in Section 5 we illustrate and analyze the performance of the proposed approach on two numerical experiments; eventually, conclusions and prospects to this work are drawn in Section 6.

2. Formulation of the inverse problem

2.1. Reference identification problem

We consider the quasi-static evolution of an open bounded body Ω over the time interval $I_t = [0, T]$. We denote $\partial\Omega$ the boundary of Ω and assume that $\partial\Omega = \overline{\partial\Omega_u} \cup \partial\Omega_T$, with $\partial\Omega_u \cap \partial\Omega_T = \emptyset$, $\partial\Omega_u$ being the support of Dirichlet boundary conditions and $\partial\Omega_T$ the support of Neumann boundary conditions. Assuming small deformations and isothermal conditions, the considered non-linear structural mechanics problem which describes the evolution of the body over the space-time domain reads: find the displacement field $\mathbf{u}(\mathbf{x}, t)$ and the stress field $\boldsymbol{\sigma}(\mathbf{x}, t)$ with $(\mathbf{x}, t) \in \Omega \times I_t$ which satisfy:

1. the kinematic constraints

$$\mathbf{u} = \mathbf{u}^d \quad \forall (\mathbf{x}, t) \in \partial\Omega_u \times I_t \quad (1)$$

2. the balance equations

$$\begin{cases} \operatorname{div} \boldsymbol{\sigma} + \mathbf{f}^d = \mathbf{0} & \forall (\mathbf{x}, t) \in \Omega \times I_t \\ \boldsymbol{\sigma} \cdot \mathbf{n} = \mathbf{T}^d & \forall (\mathbf{x}, t) \in \partial\Omega_T \times I_t \end{cases} \quad (2)$$

3. the (nonlinear) constitutive relation:

$$\boldsymbol{\sigma} = \mathcal{A}(\dot{\boldsymbol{\varepsilon}}|_{\tau}, \tau \leq t) \quad \forall (\mathbf{x}, t) \in \Omega \times I_t \quad (3)$$

as well as initial conditions. $\boldsymbol{\varepsilon} = \nabla^S(\mathbf{u})$ denotes the linearized strain tensor, while fields \mathbf{u}^d , \mathbf{f}^d , and \mathbf{T}^d represent the prescribed loading in terms of displacements, body forces, and tractions, respectively. In the particular case where a linear elasticity model is considered, the constitutive relation (3) reads:

$$\boldsymbol{\sigma} = \mathcal{C}\boldsymbol{\varepsilon}(\mathbf{u}) \quad (4)$$

where \mathcal{C} is the Hooke tensor.

In the framework of numerical simulation and computational mechanics, the classical procedure (referred to as the direct problem) consists in solving (1-3) from inputs (geometry, materials, boundary conditions, loadings, ...) in order to determine outputs $(\mathbf{u}, \boldsymbol{\sigma})$. This may be performed using the finite element method. In the context of parameter identification and model updating, the procedure is inverted and leads to an inverse problem: from a subset of inputs and additional outputs (i.e. measured observations on the physical system), it consists in identifying the missing input data. In other words, from experimental observations and a numerical model, we search to identify the unknown input parameters of the numerical model which allow the best match between the model predictions and the observations at hand.

Focusing on its solution by deterministic approaches, the general formulation of an inverse problem reads:

$$\boldsymbol{\xi}_{solution} = \underset{\boldsymbol{\xi} \in \mathcal{P}}{\operatorname{argmin}} \mathcal{J}(\boldsymbol{\xi}; \mathbf{s}) \quad (5)$$

where $\boldsymbol{\xi}$ are unknown model parameters to be identified, \mathbf{s} are observations, and \mathcal{J} is a given (least-square-type) cost function that involves the gap between observations \mathbf{s} and outputs $\mathbf{u}(\boldsymbol{\xi})$ reconstructed from (parts of) the model with input parameters $\boldsymbol{\xi}$. This cost function usually incorporates a regularization term as well [56], in order to circumvent numerical difficulties associated with the ill-posed feature of inverse problems in most practical applications. The solution to (5) can be performed by means of usual numerical approaches such as first order steepest descent methods (with the adjoint state method to evaluate gradients) or the Levenberg-Marquardt algorithm.

2.2. The original modified Constitutive Relation Error

Among all possible cost functions, and temporarily focusing on linear elasticity problems, we detail here the modified Constitutive Relation Error (mCRE) functional initially introduced in [41]. It is an energy functional based on two terms: (i) a modeling error term which measures the residual in the constitutive equation (CRE measure); (ii) a measurement discrepancy term. Using notations introduced previously, the mCRE functional \mathcal{E}_m is defined as:

$$\begin{aligned} \mathcal{E}_m^2(\mathbf{u}_{ad}, \boldsymbol{\sigma}_{ad}; \boldsymbol{\xi}) = & \frac{1}{2} \int_{I_t} \int_{\Omega} (\boldsymbol{\sigma}_{ad} - \mathbf{C} : \boldsymbol{\varepsilon}(\mathbf{u}_{ad})) : \mathbf{C}^{-1} : (\boldsymbol{\sigma}_{ad} - \mathbf{C} : \boldsymbol{\varepsilon}(\mathbf{u}_{ad})) \, dxdt \\ & + \frac{\gamma}{2} \int_{I_t} \|\boldsymbol{\Pi} \mathbf{u}_{ad} - \mathbf{s}\|_2^2 dt \end{aligned} \quad (6)$$

where $(\mathbf{u}_{ad}, \boldsymbol{\sigma}_{ad}) \in \mathcal{U}_{ad} \times \mathcal{S}_{ad}$ are displacement vector and stress tensor, respectively, which are admissible i.e. which satisfy kinematic constraints (1) and balance equations (2) (in the weak sense of FE analysis usually), $\|\cdot\|_2$ is the classical (potentially weighted) Euclidean norm, and $\gamma \in \mathbb{R}_+$ is a scalar coefficient that weighs the influence of the measurement discrepancy term besides the modeling error term. In practice this weighting coefficient is chosen by means of methods similar to these used to compute the Tikhonov regularization coefficient, for instance L-curve, Morozov [51], or Arcangeli [4] principles.

The inverse problem solution using the mCRE functional is defined as the result of the following nested minimization problem:

$$\boldsymbol{\xi}_{solution} = \underset{\boldsymbol{\xi} \in \mathcal{P}}{\operatorname{argmin}} \min_{(\mathbf{u}_{ad}, \boldsymbol{\sigma}_{ad}) \in \mathcal{U}_{ad} \times \mathcal{S}_{ad}} \mathcal{E}_m^2(\mathbf{u}_{ad}, \boldsymbol{\sigma}_{ad}; \boldsymbol{\xi}) \quad (7)$$

In practice this problem is addressed using an alternated minimization. The approach was used in many inverse problem applications in the literature, see for instance [16, 9, 8] for recent applications, or [52, 8, 33] for heterogeneous material properties field identification involving observations coming from digital image correlation. Furthermore, its robustness when considering highly corrupted data was demonstrated in [26]. Nevertheless, the modified Constitutive Relation Error solution has the drawback to be computationally expensive, particularly for evolution problems in which the admissible fields computation requires a specific numerical treatment in order to be numerically competitive [26, 9, 48].

Until now, and in spite of its large advantages, a main limitation of the original formulation of the mCRE functional comes from its lack of abstraction. Actually, the functional was clearly defined in the case of linear elasticity behavior alone, with static or dynamic regimes. From the best of our knowledge, there are very few references attempting to apply the mCRE approach to nonlinear problems [3, 46, 53, 24, 7]; most of them deal with elastic damage behavior and introduce a functional which is not strictly speaking a sound and natural definition of the mCRE functional in the nonlinear context. This is to

circumvent this issue that we propose in the following a general formulation of the mCRE approach which enables to deal with a large class of nonlinear material behaviors.

3. General formulation of the modified Constitutive Relation Error

3.1. The CRE concept for nonlinear material behaviors

In order to extend and generalize the concept of the modified Constitutive Relation Error to nonlinear behaviors, we choose to start from the origin of this functional that is the theory of the Constitutive Relation Error (CRE) used for *a posteriori* discretization error estimation in the FEM context (see [42, 39] for an overview). From its original definition for linear thermal or elasticity problems, several extended formulations of the CRE concept have been proposed over the years in the case of nonlinear behaviors [42]. The first one (referred to as the Drucker error), was introduced for dynamics problems and is based on the Drucker material stability principle. The second one, introduced in [40] and referred to as the dissipation error, is based on the definition of a residual associated to dissipation phenomena alone. The last and more general one, introduced in [45, 38], is used in the present paper as a starting point for the extension of the mCRE to nonlinear behaviors. It is described in the remainder of this section considering the large class of material behaviors with standard formulation.

In the general definition of the CRE functional given in [45, 38], a key point is the formulation of the nonlinear constitutive relation (3) in terms of state equations and evolution laws [30, 31, 47]. Using the thermodynamical framework, we introduce the convex Helmholtz free energy potential ψ :

$$\psi := \psi(T, \boldsymbol{\varepsilon}, \boldsymbol{\varepsilon}_p, V_i) = \psi(T, \boldsymbol{\varepsilon}_e, V_i) \quad (8)$$

that depends on state variables, i.e. observable variables (temperature T and strain tensor $\boldsymbol{\varepsilon}$) and internal variables: (i) the inelastic part $\boldsymbol{\varepsilon}_p$ of the strain tensor, such that $\boldsymbol{\varepsilon} = \boldsymbol{\varepsilon}_e + \boldsymbol{\varepsilon}_p$; (ii) additional internal variables V_i . Then, the two first principles of thermodynamics lead to the Clausius-Duhem inequality (9):

$$(\boldsymbol{\sigma} - \partial_{\boldsymbol{\varepsilon}_e} \rho \psi) : \dot{\boldsymbol{\varepsilon}}_e - \rho (s + \partial_T \psi) \dot{T} - \sum_i \partial_{V_i} \rho \psi \circ \dot{V}_i + \boldsymbol{\sigma} : \dot{\boldsymbol{\varepsilon}}_p - \frac{\mathbf{q} \cdot \nabla T}{T} \geq 0 \quad (9)$$

where ρ is the mass density, s is the entropy, and \mathbf{q} is the thermal flux. The notation ∂_* refers to the (generalized) gradient with respect to $*$. Consequently, considering non-dissipative transformations leads in particular to the relation:

$$\boldsymbol{\sigma} = \partial_{\boldsymbol{\varepsilon}_e} \rho \psi \quad (10)$$

Similarly, we can introduce thermodynamical loads associated with internal variables V_i :

$$Y_i = \partial_{V_i} \rho \psi \quad (11)$$

so that (9) can be recast in the following condensed format:

$$\boldsymbol{\sigma} : \dot{\boldsymbol{\varepsilon}}_p - \mathbf{Y}_i \cdot \dot{\mathbf{V}}_i - \frac{\mathbf{q} \cdot \nabla T}{T} \geq 0 \quad (12)$$

We mention that (10) and (11) constitute the state equations of the material behavior. It is shown in [37] that considering the large class of material behaviors with normal formulation, it is always possible to define sets \mathbf{V}_i and \mathbf{Y}_i (using a change of variables if required) so that state equations are linear, i.e. the free energy potential ψ is quadratic.

By duality, we can define the Gibbs free energy potential, denoted ψ^* , as the Legendre-Fenchel transform of the Helmholtz free energy (8):

$$\psi^*(T, \boldsymbol{\sigma}, \mathbf{Y}_i) = \sup_{\boldsymbol{\varepsilon}_e, \mathbf{V}_i} (\boldsymbol{\sigma} : \boldsymbol{\varepsilon}_e + \mathbf{Y}_i \cdot \mathbf{V}_i - \psi(T, \boldsymbol{\varepsilon}_e, \mathbf{V}_i)) \quad (13)$$

so that $\psi(T, \boldsymbol{\varepsilon}_e, \mathbf{V}_i) + \psi^*(T, \boldsymbol{\sigma}, \mathbf{Y}_i) - \boldsymbol{\sigma} : \boldsymbol{\varepsilon}_e - \mathbf{Y}_i \cdot \mathbf{V}_i \geq 0$. Then, it can be shown [50] that state equations can be equivalently recast as:

$$\psi(T, \boldsymbol{\varepsilon}_e, \mathbf{V}_i) + \psi^*(T, \boldsymbol{\sigma}, \mathbf{Y}_i) - \langle (\boldsymbol{\sigma}, \mathbf{Y}_i), (\boldsymbol{\varepsilon}_e, \mathbf{V}_i) \rangle = 0 \quad (14)$$

where we introduced the notation $\langle (\boldsymbol{\sigma}, \mathbf{Y}_i), (\boldsymbol{\varepsilon}_e, \mathbf{V}_i) \rangle = \boldsymbol{\sigma} : \boldsymbol{\varepsilon}_e + \mathbf{Y}_i \cdot \mathbf{V}_i$.

Remark 1. As thermal effects are not considered in the present work (isothermal conditions), the temperature variable T will be deliberately omitted in the remainder of the paper.

The inequality (12) reflects the dissipative evolution phenomena associated with the nonlinear material behavior. In particular, it prescribes a consistency condition on the pair of variables $((\boldsymbol{\varepsilon}_p, \mathbf{V}_i), (\boldsymbol{\sigma}, \mathbf{Y}_i))$ in order to ensure that the intrinsic part $\boldsymbol{\sigma} : \dot{\boldsymbol{\varepsilon}}_p - \mathbf{Y}_i \cdot \dot{\mathbf{V}}_i$ of the dissipation remains positive. To satisfy the previous condition, it is usual and convenient to introduce a convex dissipation pseudo-potential, denoted $\varphi(\dot{\boldsymbol{\varepsilon}}_p, -\dot{\mathbf{V}}_i)$, as well as its dual potential (defined using the Legendre-Fenchel transform):

$$\varphi^*(\boldsymbol{\sigma}, \mathbf{Y}_i) = \sup_{\dot{\boldsymbol{\varepsilon}}_p, \dot{\mathbf{V}}_i} \left(\langle (\boldsymbol{\sigma}, \mathbf{Y}_i), (\dot{\boldsymbol{\varepsilon}}_p, -\dot{\mathbf{V}}_i) \rangle - \varphi(\dot{\boldsymbol{\varepsilon}}_p, -\dot{\mathbf{V}}_i) \right) \quad (15)$$

Then, evolution laws are defined from the gradients of potential φ (or φ^*), involving an operator \mathcal{B} :

$$(\dot{\boldsymbol{\varepsilon}}_p, -\dot{\mathbf{V}}_i) = \mathcal{B}((\boldsymbol{\sigma}, \mathbf{Y}_i)) = \partial_{(\boldsymbol{\sigma}, \mathbf{Y}_i)} \varphi^*(\boldsymbol{\sigma}, \mathbf{Y}_i) \quad (16)$$

so that the Clausius-Duhem inequality (12), which comes down to positive definite properties of the operator \mathcal{B} :

$$(\boldsymbol{\sigma}, \mathbf{Y}_i) \cdot \mathcal{B}((\boldsymbol{\sigma}, \mathbf{Y}_i)) \geq 0 \quad (17)$$

is naturally satisfied since dissipation pseudo-potentials are chosen convex and such that $\varphi(\mathbf{0}, \mathbf{0}) = \varphi^*(\mathbf{0}, \mathbf{0}) = 0$.

Remark 2. It can be shown in some cases that there is a relation which links the free energy and dissipation potentials. This additional relation comes from the Drucker-Illuyshin postulate and refers to the class of generalized standard materials [30, 31, 49].

From the previous thermodynamical formulation of nonlinear behaviors, a general CRE measure was derived in [45] by means of residuals on: (i) the state equations; (ii) the evolution laws. These residuals are defined using the Legendre-Fenchel inequality applied to the corresponding thermodynamical potentials. They read:

- residual on the state equations:

$$\eta_\psi(\boldsymbol{\varepsilon}_e, \mathbf{V}_i, \boldsymbol{\sigma}, \mathbf{Y}_i) = \psi(\boldsymbol{\varepsilon}_e, \mathbf{V}_i) + \psi^*(\boldsymbol{\sigma}, \mathbf{Y}_i) - \langle (\boldsymbol{\sigma}, \mathbf{Y}_i), (\boldsymbol{\varepsilon}_e, \mathbf{V}_i) \rangle \geq 0 \quad (18)$$

- residual on the evolution laws:

$$\eta_\varphi(\dot{\boldsymbol{\varepsilon}}_p, -\dot{\mathbf{V}}_i, \boldsymbol{\sigma}, \mathbf{Y}_i) = \varphi(\dot{\boldsymbol{\varepsilon}}_p, -\dot{\mathbf{V}}_i) + \varphi^*(\boldsymbol{\sigma}, \mathbf{Y}_i) - \langle (\boldsymbol{\sigma}, \mathbf{Y}_i), (\dot{\boldsymbol{\varepsilon}}_p, -\dot{\mathbf{V}}_i) \rangle \geq 0 \quad (19)$$

We notice that the Legendre-Fenchel duality yields $\eta_\psi = 0$ (resp. $\eta_\varphi = 0$) when state equations (resp. evolution laws) are satisfied.

For the sake of simplicity, we denote $\boldsymbol{\Sigma} = (\boldsymbol{\varepsilon}_e, \boldsymbol{\varepsilon}_p, \mathbf{V}_i, \boldsymbol{\sigma}, \mathbf{Y}_i)$ the whole set of variables. From the two residuals (18,19), the local in space and time CRE measure e_{CRE} is defined as:

$$e_{CRE}^2(\boldsymbol{\Sigma}) = \eta_\psi(\boldsymbol{\Sigma}) + \int_0^t \eta_\varphi(\boldsymbol{\Sigma}) \, dt \quad \forall \mathbf{x} \in \Omega, \forall t \in I_t \quad (20)$$

and a global measure can be obtained by integration over the space-time domain.

3.2. Extension of the mCRE functional

We now propose a general formulation of the mCRE functional based on the CRE formulation described previously. In order to extend the mCRE functional to nonlinear behaviors, we thus consider as a starting point the local error formulation (20), that we integrate over the whole space-time domain, and we augment the resulting functional by a measurement discrepancy term in a spirit similar to what was done in the original linear formulation of the mCRE (6). The resulting mCRE functional thus reads:

$$\mathcal{E}_m^2(\boldsymbol{\Sigma}, \boldsymbol{\xi}) = \int_{I_t} \int_\Omega \eta_\psi(\boldsymbol{\Sigma}) \, dxdt + \int_{I_t} \int_\Omega \int_0^t \eta_\varphi(\boldsymbol{\Sigma}) \, d\tau dxdt + \frac{\gamma}{2} \int_{I_t} \|\boldsymbol{\Pi} \mathbf{u} - \mathbf{s}\|_2^2 dt \quad (21)$$

The functional (21) is general and can be used with a large class of nonlinear behaviors. Indeed, only minimalistic assumptions on the material behavior are made since a thermodynamical formulation in terms of free energy and

dissipation pseudo-potentials is required, which is the framework of standard formulations [31]. In addition, as it is naturally derived from the thermodynamical framework, this functional keeps advantages associated with convexity properties. We can observe that the functional (21) is composed as a sum of integral terms: (i) the two first integrands come from the Legendre-Fenchel inequality; (ii) the last term is a least-square error term.

From this extended formulation of the mCRE functional we define the inverse problem in the same way as in the linear case (see Section 2.2). Therefore, the solution to the identification or model updating process corresponds to the parameter set $\xi_{solution}$ which satisfies the following nested minimization problem:

$$\xi_{solution} = \operatorname{argmin}_{\xi \in \mathcal{P}} \min_{\mathbf{F}(\Sigma_{ad})=\mathbf{0}} \mathcal{E}_m^2(\Sigma_{ad}; \xi) \quad (22)$$

The constraints $\mathbf{F}(\Sigma_{ad}) = \mathbf{0}$ correspond to the notion of admissibility and require that the set of variables Σ_{ad} satisfies: (i) the balance equations; (ii) the Neumann and Dirichlet boundary conditions; (iii) the initial conditions.

In practice this problem is solved by means of an alternated minimization scheme:

1. for a given parameter vector $\xi^{(k)}$, an optimal admissible set $\tilde{\Sigma}_{ad}$ is computed by solving:

$$\tilde{\Sigma}_{ad} = \operatorname{argmin}_{\mathbf{F}(\Sigma_{ad})=\mathbf{0}} \mathcal{E}_m^2(\Sigma_{ad}; \xi^{(k)}) \quad (23)$$

2. from this admissible set $\tilde{\Sigma}_{ad}$, a new parameter vector is computed by solving:

$$\xi^{(k+1)} = \operatorname{argmin}_{\xi \in \mathcal{P}} \mathcal{E}_m^2(\tilde{\Sigma}_{ad}; \xi) \quad (24)$$

The more expensive and difficult operation in this approach is the first minimization; we propose in the next section a dedicated procedure to address this issue.

4. Practical solution to the identification problem

In this section we present a specific numerical approach for the computation of optimal admissible fields (first minimization in the previous inversion scheme) based on the mathematical properties of the nonlinear mCRE functional. We also detail technical aspects associated with the global inverse problem solution deployed in this framework.

4.1. First step - computation of optimal admissible fields

The first stage of the inverse problem solution using the modified Constitutive Relation Error is the computation of an optimal admissible set $\widetilde{\Sigma}_{ad}$ for a given parameter vector ξ . This computation is defined in terms of the constrained minimization (23) where the constraints are defined as:

$$\mathbf{F}(\Sigma_{ad}) = \mathbf{0} \Leftrightarrow \begin{cases} \operatorname{div} \boldsymbol{\sigma}_{ad} + \mathbf{f}^d = \mathbf{0} & \forall (\mathbf{x}, t) \in \Omega \times I_t \\ \mathbf{u}_{ad} = \mathbf{u}^d & \forall (\mathbf{x}, t) \in \partial_u \Omega \times I_t \\ \boldsymbol{\sigma}_{ad} \cdot \mathbf{n} = \mathbf{T}^d & \forall (\mathbf{x}, t) \in \partial_T \Omega \times I_t \end{cases} \quad (25)$$

in addition to initial conditions.

A possible methodology to solve the minimization (23) would be to introduce a Lagrange multiplier field in order to take into account the previous constraints (mainly the equilibrium equations) into the mCRE functional and write the stationarity conditions of the associated Lagrangian. Although this approach is feasible, it has some disadvantages: (i) stationarity conditions may be very complex to express; (ii) the integration of history in the term associated to dissipation (residual on evolution laws) implies to introduce, during the calculation of stationarity conditions, an incremental time discretization scheme.

In order to avoid these drawbacks, especially the second one, we investigate here another approach. The proposed solution scheme is based on the observation that the mCRE functional is a sum of positive terms. Indeed, the two first terms of the functional are derived from the Legendre-Fenchel inequality and are therefore necessarily positive by definition, while the last term is the square of a norm. From this statement, we choose to split in two parts the mCRE functional and then to transform the initial constrained minimization under the form of two coupled minimizations. The splitting of the functional is performed as follows:

- in a first functional we consider the residual on state equations and the measurement discrepancy term:

$$\mathcal{E}_\psi^2(\Sigma^\psi) = \int_{I_t} \int_{\Omega} \eta_\psi(\Sigma^\psi) d\mathbf{x} dt + \frac{\gamma}{2} \int_{I_t} \|\Pi \mathbf{u} - \mathbf{s}\|_2^2 dt \quad (26)$$

- in a second functional we consider the residual on evolution laws:

$$\mathcal{E}_\varphi^2(\Sigma^\varphi) = \int_{I_t} \int_{\Omega} \int_0^t \eta_\varphi(\Sigma^\varphi) d\tau d\mathbf{x} dt \quad (27)$$

The two constrained sets of variables Σ^ψ and Σ^φ , subsets of Σ , are defined in the following way:

- Σ^ψ is the variable set considered when dealing with the functional \mathcal{E}_ψ^2 . In this set, all internal variables driven by the material evolution law (i.e. damage variable, plastic strain, cumulated plasticity, ...) are fixed and only \mathbf{u} (or $\boldsymbol{\varepsilon}(\mathbf{u}) = \boldsymbol{\varepsilon}_e + \boldsymbol{\varepsilon}_p$) and $\boldsymbol{\sigma}$ are unknown;

- Σ^φ is the variable set considered when dealing with the functional \mathcal{E}_φ^2 . In this set, the variable $\varepsilon(\mathbf{u})$ is fixed, and all other variables are unknown.

Remark 3. The sets Σ^ψ and Σ^φ , introduced to ensure a better understanding of the proposed approach, correspond to the original parameter set Σ in which some variables are unknowns and others are fixed. They enable to consider reduced minimization spaces that ensure convergence of the fixed point strategy defined below (see the proof given in [37, Section 4.5.3, Theorem 1] for the general framework of the LaTIn method). The only variable computed in both minimizations is the stress tensor σ .

From this splitting, we define the computation of the optimal admissible set as the solution to the following coupled system:

$$\begin{cases} \min_{\mathbf{F}(\Sigma_{ad}^\psi)=\mathbf{0}} \mathcal{E}_\psi(\Sigma_{ad}^\psi) \\ \min_{\hat{\mathbf{F}}(\Sigma_{ad}^\varphi)=\mathbf{0}} \mathcal{E}_\varphi(\Sigma_{ad}^\varphi) \end{cases} \quad (28)$$

Constraints $\mathbf{F}(\Sigma_{ad}^\psi) = \mathbf{0}$ involve equilibrium equations and boundary conditions, while constraints $\hat{\mathbf{F}}(\Sigma_{ad}^\varphi) = \mathbf{0}$ involve initial conditions alone. Each constrained minimization problem can be solved by introducing Lagrange multipliers. In practice, the two problems are solved alternatively with a fixed point algorithm.

4.2. First step - details on the fixed point algorithm

We detail below the two problems to be solved alternatively:

1. constrained minimization of \mathcal{E}_ψ :

$$\min_{\mathbf{F}(\Sigma_{ad}^\psi)=\mathbf{0}} \mathcal{E}_\psi(\Sigma_{ad}^\psi) \quad (29)$$

Introducing a Lagrange multiplier field and writing stationarity conditions leads to the formulation of a problem which is global over the whole space domain but which is **linear**. Its solution at iteration $n+1$ of the algorithm is denoted $\hat{\Sigma}^{(n+1/2)}$;

2. constrained minimization of \mathcal{E}_φ :

$$\min_{\hat{\mathbf{F}}(\Sigma_{ad}^\varphi)=\mathbf{0}} \mathcal{E}_\varphi(\Sigma_{ad}^\varphi) \quad (30)$$

Introducing a Lagrange multiplier field and writing stationarity conditions leads to the formulation of a nonlinear evolution problem but which is **local** in space (i.e. defined at the integration point level). Its solution at iteration $n+1$ of the algorithm is denoted $\Sigma^{(n+1)}$.

The splitting of the mCRE functional thus leads to the formulation of: (i) a linear and global in space problem; (ii) a nonlinear and local in space problem. Both problems are global in time. This invites to use a solution scheme similar to the Large Time Increment (LaTIn) method [35, 37]. The solution process we propose, inspired from the LaTIn method, is based on the definition of two spaces:

- a linear space:

$$A_d = \arg \min_{F(\Sigma_{ad}^\psi)=0} \mathcal{E}_\psi(\Sigma_{ad}^\psi; \xi) \quad (31)$$

- a local space:

$$\Gamma = \arg \min_{\hat{F}(\Sigma_{ad}^\varphi)=0} \mathcal{E}_\varphi(\Sigma_{ad}^\varphi; \xi) \quad (32)$$

These two spaces define the solution to problem (23), i.e. the optimal admissible set $\tilde{\Sigma}_{ad}$ according to the mCRE functional (21) corresponds to the intersection of the two spaces (33):

$$\tilde{\Sigma}_{ad} = A_d \cap \Gamma \quad (33)$$

In Figure 2 we give a graphical representation, classical in the framework of the LaTIn method, of the successive minimization solutions in A_d and Γ leading to $\tilde{\Sigma}_{ad}$.

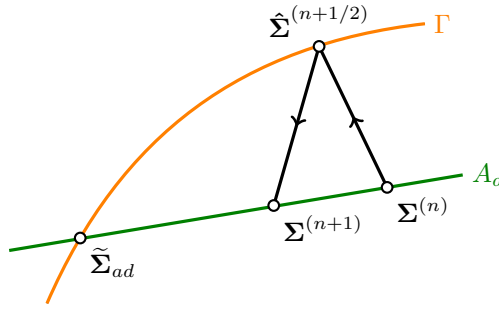

Figure 2: Graphical interpretation of the LaTIn method

Eventually, and still in the spirit of the LaTIn method, a link between the two minimization problems is made by means of two parameters of the solution scheme which are the up and down directions, respectively denoted \mathbf{E}^+ and \mathbf{E}^- . These are introduced in the two stages of the numerical method:

local stage : given $\Sigma^{(n)} \in A_d$, find $\hat{\Sigma}^{(n+1/2)} \in \Gamma$ such that

$$\left(\hat{\Sigma}^{(n+1/2)} - \Sigma^{(n)} \right) \in \mathbf{E}^+ \quad (34)$$

Different choices are possible for \mathbf{E}^+ and are discussed in [37]. Here, we consider the up direction that consists in imposing the strain tensor computed at the previous linear stage i.e. $\hat{\epsilon}^{(n+1/2)} = \epsilon^{(n)}$. It is referred as “infinity” direction in the literature, as it corresponds to a vertical slope in the graph of Figure 2. Considering such a direction leads to a nonlinear local problem driven in terms of strain which ensures a better convergence.

linear stage : given $\hat{\Sigma}^{(n+1/2)} \in \Gamma$, find $\Sigma^{(n+1)} \in A_d$ such that

$$\left(\Sigma^{(n+1)} - \hat{\Sigma}^{(n+1/2)} \right) \in \mathbf{E}^- \quad (35)$$

The optimal choice for \mathbf{E}^- is obviously the tangent direction to the local space Γ , similarly to a classical Newton approach. Nevertheless, this choice requires to compute tangent operators at each iteration. For a sake of simplicity, we choose here to consider an elastic down direction, i.e. we use the elastic stiffness matrix. In the particular case of damage problem, we use the stiffness matrix computed from the damaged material.

A more practical explanation of the LaTIn method is the description of the material integration step. Indeed, in a classical incremental Newton approach the material integration is realized in a single step at each integration point for a given time increment (more detailed explanations on this vision can be found in [28]). Conversely, in the numerical approach we propose here and in the same way as in the LaTIn method, the material integration step is performed in two stages:

1. the local integration: it corresponds to the integration of the evolution laws, i.e. the computation of the nonlinear evolutions. This stage only implies computations at the integration point level, so that this stage can be strongly parallelized. More precisely, at a given iteration, the entire evolution of the internal variables characterizing the nonlinearities is computed from the whole history coming from the linear space A_d ;
2. the linear integration: it corresponds to the evaluation of the state equations. This stage implies computations at the integration point level and an assembly stage to compute a global linear system (stiffness matrix and internal reactions). This step is obviously performed knowing the entire evolution of the internal variables coming from the local integration step. The time aspect is taken into account by solving an incremental linear system explicitly.

A graphical representation of the integration process, inspired by a similar representation used in [28] for the Newton method, is drawn in Figure 3.

Remark 4. The minimization of the functional in terms of residual on state equations and measurement discrepancy, performed in the linear stage, leads to an incremental linear system of the following form:

$$\begin{bmatrix} \mathbf{K} & -\mathbf{K} \\ \gamma \mathbf{\Pi}^T \mathbf{\Pi} & \mathbf{K} \end{bmatrix} \begin{Bmatrix} \Delta \mathbf{U} \\ \Delta \mathbf{\Lambda} \end{Bmatrix} = \begin{Bmatrix} \mathbf{F}_{ext} \\ \mathbf{F}_{obs} \end{Bmatrix} \quad (36)$$

where \mathbf{K} is a stiffness matrix. In order to avoid the expensive factorization of a $2 \cdot n_{dof} \times 2 \cdot n_{dof}$ matrix (n_{dof} being the number of dofs in the direct problem), a natural approach consists in performing the solution in two parts:

1. $(\mathbf{K} + \gamma \mathbf{\Pi}^T \mathbf{\Pi}) \Delta \mathbf{U} = \mathbf{F}_{ext} - \mathbf{F}_{obs}$

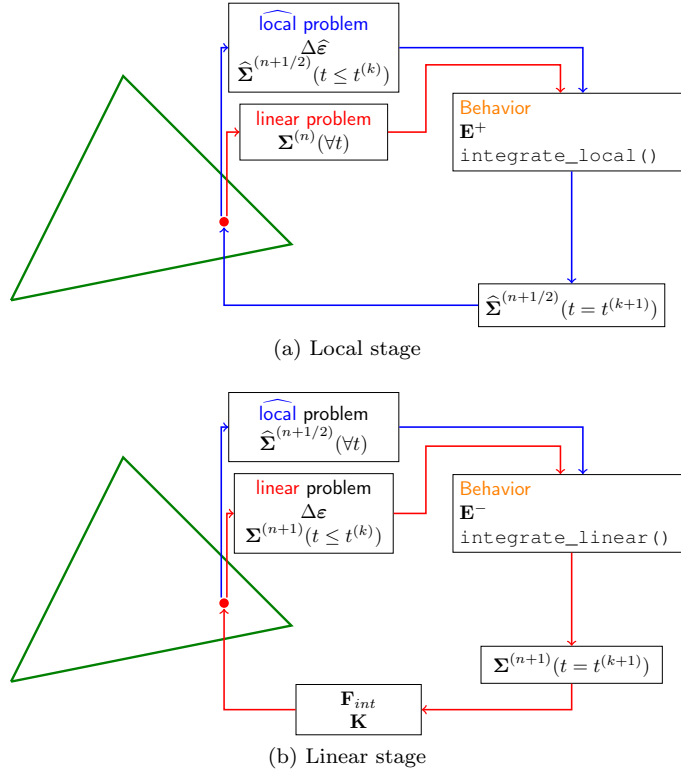

Figure 3: Material integration in the proposed solution scheme (n refers to the iterations of the LaTIn solver, while k refers to loading increments)

$$2. \mathbf{K}\Delta\Lambda = \mathbf{F}_{ext} + \mathbf{F}_{obs} - \gamma\Pi^T\Pi\Delta U$$

The issue with this latter approach comes from the fact that it is then necessary to perform two factorizations: (i) the first one for $(\mathbf{K} + \gamma\Pi^T\Pi)$; (ii) the second one for \mathbf{K} . Consequently, the complexity of the solution, initially in $O((2 \cdot n_{dof})^3)$, becomes in $2 \cdot O(n_{dof}^3)$. Nevertheless we can observe that the two matrices to be factorized are very similar, so that the computational cost can be again reduced using the Sherman-Morrison-Woodbury formula:

$$(\mathbf{K} + \gamma\Pi^T\Pi)^{-1} = \mathbf{K}^{-1} - \mathbf{K}^{-1}\gamma\Pi^T(\mathbf{1} + \gamma\Pi\mathbf{K}^{-1}\Pi^T)^{-1}\Pi\mathbf{K}^{-1} \quad (37)$$

It is then necessary to compute only one factorization of \mathbf{K} and another one for $\mathbf{1} + \gamma\Pi\mathbf{K}^{-1}\Pi^T$ which is a low rank matrix of size $n_{obs} \times n_{obs}$ that is to say a very small matrix in the case of sparse sensor placement. Using (37), the computational complexity to solve the system (36) decreases from $O((2 \cdot n_{dof})^3)$ to $O(n_{dof}^3) + O(n_{obs}^3)$ which represents a real computational saving especially when considering representative industrial cases.

4.3. Second step - minimization over the parameter space

In the proposed mCRE approach, the second step at the k -th iteration of the inverse problem solution is the minimization of the mCRE functional with respect to parameters (for fixed $\tilde{\Sigma}_{ad}$):

$$\boldsymbol{\xi}^{(k)} = \underset{\boldsymbol{\xi} \in \mathcal{P}}{\operatorname{argmin}} \mathcal{E}_m \left(\tilde{\Sigma}_{ad}, \boldsymbol{\xi} \right) \quad (38)$$

In order to solve this minimization problem, the various optimization methods available in the literature can be used. Nevertheless, a convenient approach is to use the fact that to compute the optimal admissible set $\tilde{\Sigma}_{ad}$, stationarity conditions of a Lagrangian \mathcal{L} defined from the functional to be minimized have been searched. Therefore it is natural to solve the minimization problem (38) using the adjoint approach [21]. Indeed, considering the adjoint framework, the gradient of the cost function to be minimized is easily computed at $\boldsymbol{\xi} = \boldsymbol{\xi}^{(k)}$ as:

$$\nabla_{\boldsymbol{\xi}} \mathcal{E}_m^2(\tilde{\Sigma}_{ad}, \boldsymbol{\xi}^{(k)}) = \frac{\partial}{\partial \boldsymbol{\xi}} \mathcal{L} \left(\tilde{\Sigma}_{ad}, \boldsymbol{\xi}^{(k)}, \boldsymbol{\lambda} \right) \quad (39)$$

where $\boldsymbol{\lambda}$ denotes the Lagrange multiplier field. This gradient is then used as a constant descent direction in the iterative gradient method used to solve (38). This approach is similar to that used in [15].

5. Numerical results

In this section, we illustrate the methodology and computation strategy on two numerical experiments involving parameter identification with nonlinear behaviors. In both cases, the identification process required between 10 and 15 LaTIn sub-iterations at iteration 1 of the process, then between 3 and 5 sub-iterations at other iterations. This decrease in the number of sub-iterations from iteration 2 is due to the fact that the LaTIn initialization is then performed from fields computed at the previous iteration.

5.1. Parameter identification with an elastic damage behavior

5.1.1. Specific formulation for the computation of the optimal admissible set

In this first example we consider an elastic damage behavior, with isotropic damage. In order to circumvent some numerical difficulties associated with softening behaviors (in particular mesh dependency related to loss of ellipticity), we choose here to consider a regularizing delay-damage model as introduced in [36, 1, 53]. The delay-damage model is formulated as:

$$\begin{cases} \dot{d} = \frac{k}{a} \left(1 - \exp \left[-a \left\langle \frac{Y - Y_0 - \beta}{Y_c - Y_0} \right\rangle_+ \right] \right) \\ -\dot{\alpha} = -\dot{d} \end{cases} \quad (40)$$

where $d \in [0, 1]$ is the damage variable, α is an internal variable used to model the strain hardening (β is the associated thermodynamical load), $Y = \frac{1}{2} \boldsymbol{\varepsilon} : \boldsymbol{C} : \boldsymbol{\varepsilon}$,

Y_c and Y_0 are material parameters (energy rates), and k and a are parameters of the evolution law. For this behavior, the free energy and dissipation potentials are defined as:

$$\begin{aligned}\psi(\boldsymbol{\sigma}, d, \alpha) &= \frac{1}{2} \frac{\boldsymbol{\sigma} : \mathbf{C}^{-1} : \boldsymbol{\sigma}}{1-d} + \frac{(Y_c - Y_0)}{3} \alpha^3 + \Psi_{d \leq 1} & (41) \\ \varphi^*(Y, \beta) &= \frac{k}{a} \left[\langle Y - Y_0 - \beta \rangle_+ + \frac{Y_c - Y_0}{a} \left(\exp \left(-\frac{a \langle Y - Y_0 - \beta \rangle_+}{Y_c - Y_0} \right) - 1 \right) \right] & (42)\end{aligned}$$

where Ψ is the indicatrix function. The two dual associated potentials then read:

$$\psi^*(\boldsymbol{\varepsilon}, Y, \beta) = Y + \frac{2}{3} \frac{|\beta|^{3/2}}{\sqrt{Y_c - Y_0}} + \Psi_{Y \leq \frac{1}{2} \boldsymbol{\varepsilon} : \mathbf{C} : \boldsymbol{\varepsilon}} \quad (43)$$

$$\varphi(d, -\dot{\alpha}) = \dot{\alpha} \frac{(a-1)Y_0 + Y_c}{a} + \left(\frac{k}{a} - d \right) \ln \left(1 - \frac{a}{k} d \right) \quad (44)$$

Remark 5. This particular choice for gathering variables into primal and dual potentials (for instance, the stress field $\boldsymbol{\sigma}$ appears here in the primal potential ψ) enables to preserve convexity properties when considering damage effects. The reader is referred to [45, 38] for full details on this technical aspect.

From these potentials we define the mCRE functional, as well as contributions \mathcal{E}_ψ^2 and \mathcal{E}_φ^2 to this functional, as described in Section 4. Then we set up a solution scheme in the spirit of the LaTIn method for the optimal admissible fields computation. As described previously, the two following spaces are introduced:

Linear space A_d associated with the solution to:

$$\min_{F(\boldsymbol{\Sigma}_{ad}^\psi)=0} \mathcal{E}_\psi^2(\boldsymbol{\Sigma}_{ad}^\psi) \quad (45)$$

In order to solve this constrained minimization problem, we introduce a field of Lagrange multipliers, denoted $\boldsymbol{\lambda}$, which leads to the definition of the Lagrangian:

$$\mathcal{L}(\boldsymbol{\Sigma}^\psi, \boldsymbol{\lambda}) = \mathcal{E}_\psi^2(\boldsymbol{\Sigma}^\psi) + \int_{I_t} \int_{\Omega} \boldsymbol{\lambda} \cdot (\operatorname{div} \boldsymbol{\sigma} + \mathbf{f}) \, dxdt \quad (46)$$

The minimization problem, **with frozen variables** $\boldsymbol{\Sigma}^\varphi$, then comes down to fulfilling stationarity conditions of \mathcal{L} . All developments done, the stationarity conditions lead to the following differential equations system:

$$\begin{cases} \int_{I_t} \int_{\Omega} \delta \boldsymbol{\lambda} \cdot (\operatorname{div} \boldsymbol{\sigma} + \mathbf{f}) \, dxdt = 0 \\ \int_{I_t} \int_{\Omega} \boldsymbol{\sigma} : \boldsymbol{\varepsilon}(\delta \mathbf{u}) \, dxdt + \int_{I_t} \gamma \langle \Pi \mathbf{u} - \mathbf{s}, \delta \mathbf{u} \rangle dt = 0 \\ \int_{I_t} \int_{\Omega} \delta \boldsymbol{\sigma} : \left(\frac{1}{1-d} \mathbf{C}^{-1} : \boldsymbol{\sigma} - \boldsymbol{\varepsilon} \right) \, dxdt + \int_{I_t} \int_{\Omega} \boldsymbol{\lambda} \cdot \operatorname{div} \delta \boldsymbol{\sigma} \, dxdt = 0 \end{cases} \quad (47)$$

Local space Γ associated with the solution to:

$$\min_{\hat{F}(\Sigma_{ad}^\varphi)=0} \mathcal{E}_\varphi^2(\Sigma_{ad}^\varphi) \quad (48)$$

Stationarity conditions of the associated Lagrangian lead to the following non-linear differential system:

$$\begin{cases} \int_{I_t} \int_{\Omega} \int_0^t \delta \dot{\alpha} \beta d\tau d\mathbf{x} dt = 0 \\ \int_{I_t} \int_{\Omega} \int_0^t \delta \beta \left(\dot{\alpha} + \frac{k \langle Y - Y_0 - \beta \rangle_+}{a |Y - Y_0 - \beta|} \left[\exp \left(-a \frac{\langle Y - Y_0 - \beta \rangle_+}{Y_0 - Y_c} \right) - 1 \right] \right) d\tau d\mathbf{x} dt = 0 \\ \int_{I_t} \int_{\Omega} \int_0^t \delta Y \left(\frac{k \langle Y - Y_0 - \beta \rangle_+}{a |Y - Y_0 - \beta|} \left[\exp \left(-a \frac{\langle Y - Y_0 - \beta \rangle_+}{Y_0 - Y_c} \right) \right] - \dot{d} \right) d\tau d\mathbf{x} dt = 0 \\ \int_{I_t} \int_{\Omega} \int_0^t \delta \dot{d} \left(\frac{(a-1)Y_0 + Y_c}{a} - Y - \ln \left(1 - \frac{a}{k} \dot{d} \right) - 1 \right) d\tau d\mathbf{x} dt = 0 \end{cases} \quad (49)$$

In practice, time integration for the solution in this local stage is performed using an explicit Euler scheme.

5.1.2. Identification of a damage model parameter in a DCB test

The problem we consider to illustrate the method using the softening behavior of Section 5.1.1 is a debonding test on a laminated composite, more precisely a Double Cantilever Beam (DCB) test, on which we search to identify the damage law parameter Y_0 . The structure and boundary conditions are described in Figure 4. It is made of a two-ply composite material in which plies have a linear elastic behavior while the interface between the two plies has an elastic damage behavior.

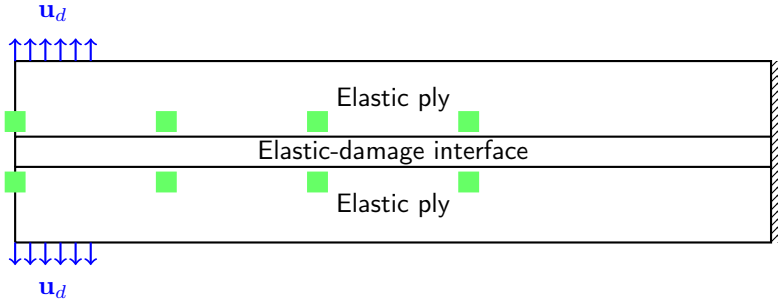

Figure 4: The considered structure with elastic damage behavior: boundary conditions and position of sensors

The structure is clamped on its right side while the external loading is made of a prescribed symmetric displacement, applied incrementally with linear evolution, on part of the boundary (see Figure 4). The material parameters used for this example are given in Table 1.

Parameter	E_{ply}	ν_{ply}	$E_{interface}$	$\nu_{interface}$	a	k	Y_0	Y_c
Value	120 GPa	0.3	57 GPa	0.3	1.	0.05	0.05	0.23

Table 1: Material parameters used for the composite debonding example

The space discretization (finite element mesh) used in the simulation is represented in Figure 5. This mesh made of 3-node triangle elements is deliberately excessively fine (25,000 dof) in order to catch at best the evolution of damage phenomena. The direct problem solution, used in order to simulate synthetic observation data, is given in Figure 6; we clearly observe the evolution of damage along the interface. The observations considered for this example are displacements at points represented in Figure 4. In addition a 1% (referring to a relative standard deviation) measurement noise is considered and introduced as a Gaussian white noise [32] in both space and time.

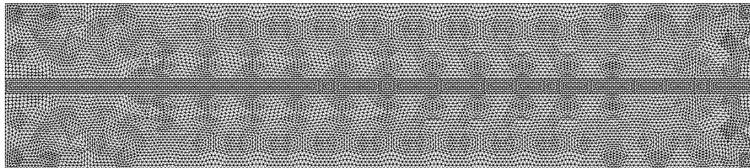

Figure 5: Elastic damage behavior example - finite element mesh

In Figure 7 we plot the evolutions during the iterations of the identification process of: (i) the mCRE functional; (ii) the relative error on the identified parameter Y_0 . We first observe that the proposed inverse problem solution seems to offer a really effective identification method since, at convergence (after only 20 iterations), the obtained relative error on the identified parameter is 1.9%. Nevertheless a surprisingly low evolution of the mCRE functional can be observed and is associated to the small variability magnitude of the functional to the identified parameter, as it can be observed in Figure 7a; a similar evolution was observed in [7]. Another possible explanation of this small decrease magnitude may be associated to the choice of the weight coefficient γ in the mCRE functional. This coefficient may be determined using a L-curve approach in order to have a similar weight between the modeling error term and the measurement discrepancy term (see for instance [15]). Here, in the context of nonlinear behaviors, such an approach becomes really expensive and we chose here not to compute an optimal value for the coefficient γ but rather use an empirical value. This value is obtained from L-curve approach the considering the same inversion problem but with a fully elastic behavior (no damage). We also represent in Figure 8 the magnitude and components of primal field \mathbf{u} and dual field $\boldsymbol{\lambda}$ at the first iteration of the identification process using mCRE.

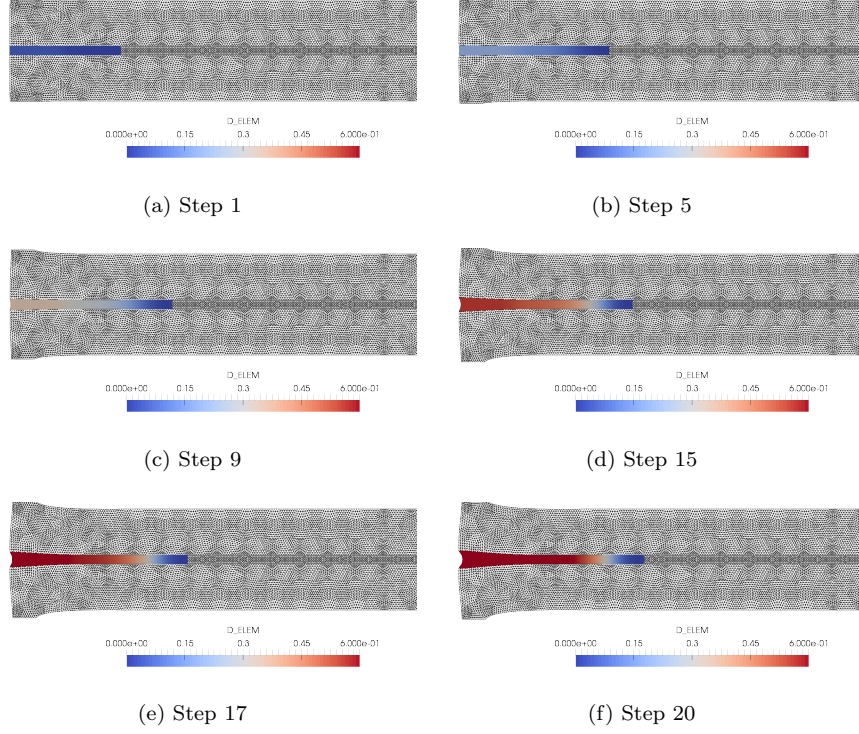

Figure 6: Elastic damage behavior example - damage evolution along the interface

An interesting observation is the spatial distribution of the dual field λ (field of Lagrange multipliers) which ensures admissibility conditions i.e. balance equations; it is mainly concentrated in the vicinity of the damaged interface, showing that there is a strong constraint to decrease the opening between the two plies. This is consistent with the fact that, the initial guess for Y_0 being small, the model tends to lead to a more important opening compared to the reference solution during the first iterations of the identification procedure.

5.2. Model updating with a visco-plastic behavior

5.2.1. Specific formulation for the computation of the optimal admissible set

In this second example we consider a Prandtl-Reuss visco-plastic behavior with linear isotropic hardening. For this behavior the free energy and dissipation potentials are defined as:

$$\psi(\boldsymbol{\varepsilon}, \boldsymbol{\varepsilon}^{vp}, p) = \frac{1}{2} (\boldsymbol{\varepsilon} - \boldsymbol{\varepsilon}^{vp}) : \boldsymbol{\mathcal{C}} : (\boldsymbol{\varepsilon} - \boldsymbol{\varepsilon}^{vp}) + g(p) \quad (50)$$

$$\varphi^*(\boldsymbol{\sigma}, R) = \frac{k_v}{n_v + 1} \langle \|\boldsymbol{\sigma}^D\| - (R + R_0) \rangle_+^{n_v + 1} \quad (51)$$

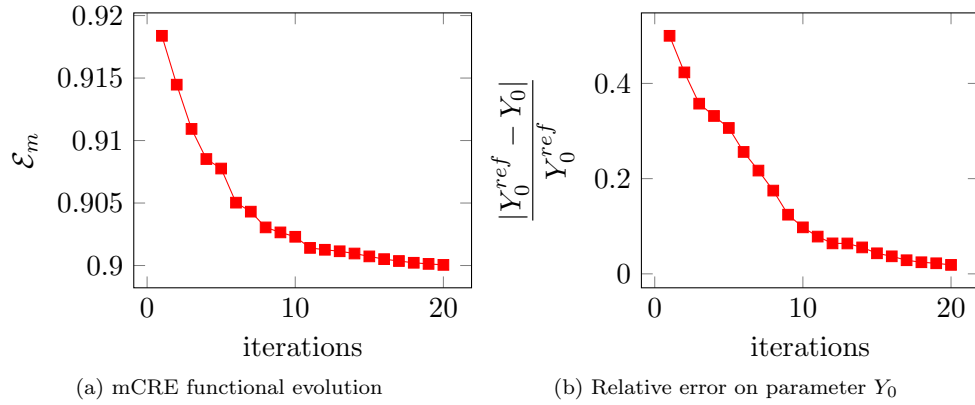

Figure 7: Elastic damage behavior example - evolution during the iterations of the mCRE functional and of the relative error on the identified parameter

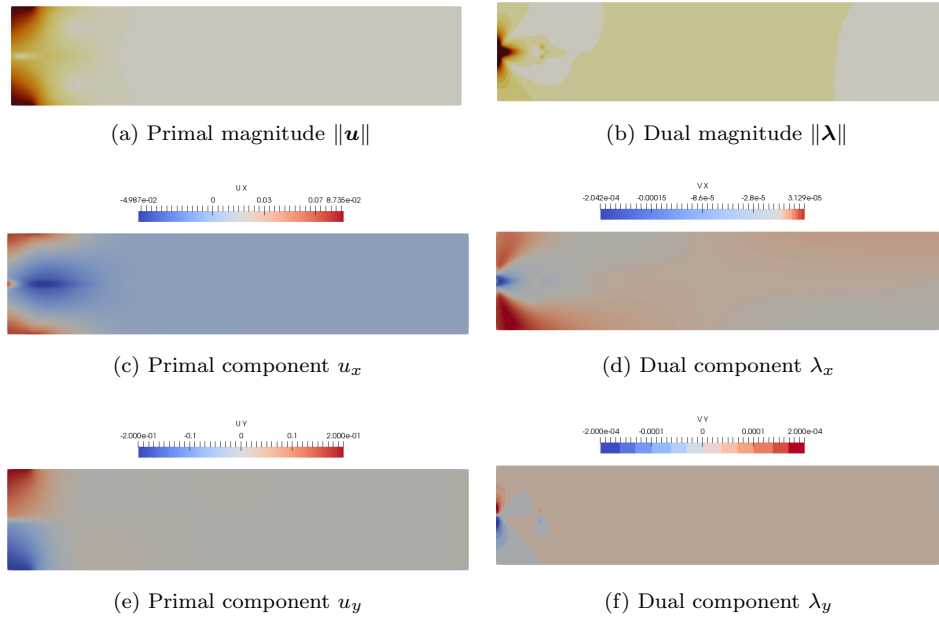

Figure 8: Elastic damage behavior example - representation of primal and dual fields \mathbf{u} and $\boldsymbol{\lambda}$ at iteration 1 of the inversion process

with $\boldsymbol{\varepsilon}^{vp}$ the visco-plastic strain, p the cumulated plasticity, $g(p)$ the potential of the isotropic hardening law chosen as linear i.e. $R(p) = R_0 + k_h p$, and R the

hardening variable. The associated dual potentials read:

$$\psi^*(\boldsymbol{\sigma}, R) = \frac{1}{2} \boldsymbol{\sigma} : \mathbf{C}^{-1} : \boldsymbol{\sigma} + g^*(R) \quad (52)$$

$$\varphi(\boldsymbol{\varepsilon}^{vp}, -\dot{p}) = R_0 \|\boldsymbol{\varepsilon}^{vp}\| + \frac{1}{(n_v + 1)k_v^{n_v}} \|\boldsymbol{\varepsilon}^{vp}\|^{n_v+1} \quad (53)$$

From these potentials we define the mCRE functional and contributions \mathcal{E}_ψ^2 and \mathcal{E}_φ^2 . We introduce the associated spaces:

Linear space A_d associated with the solution to:

$$\min_{F(\boldsymbol{\Sigma}_{ad}^\psi)=0} \mathcal{E}_\psi^2(\boldsymbol{\Sigma}_{ad}^\psi) \quad (54)$$

In order to solve this constrained minimization problem, we introduce a field of Lagrange multipliers, denoted $\boldsymbol{\lambda}$, which leads to the definition of the Lagrangian:

$$\mathcal{L}(\boldsymbol{\Sigma}^\psi, \boldsymbol{\lambda}) = \mathcal{E}_\psi^2(\boldsymbol{\Sigma}^\psi) + \int_{I_t} \int_{\Omega} \boldsymbol{\lambda} \cdot (\operatorname{div} \boldsymbol{\sigma} + \mathbf{f}) \, dxdt \quad (55)$$

The solution to the minimization problem, **with frozen variables** $\boldsymbol{\Sigma}^\varphi$, then comes down to the satisfaction of the Lagrangian stationarity conditions. All developments done, these stationarity conditions lead to the following differential equations system:

$$\begin{cases} \int_{I_t} \int_{\Omega} \boldsymbol{\delta} \boldsymbol{\lambda} (\operatorname{div} \boldsymbol{\sigma} + \mathbf{f}) \, dxdt = 0 \\ \int_{I_t} \int_{\Omega} \boldsymbol{\delta} \boldsymbol{\sigma} : (\mathbf{C}^{-1} : \boldsymbol{\sigma} - \boldsymbol{\varepsilon}^e - \boldsymbol{\varepsilon}(\boldsymbol{\lambda})) \, dxdt = 0 \\ \int_{I_t} \int_{\Omega} \boldsymbol{\varepsilon}[\boldsymbol{\delta} \mathbf{u}] : (\mathbf{C} : (\boldsymbol{\varepsilon}(\mathbf{u}) - \boldsymbol{\varepsilon}^{vp}) - \boldsymbol{\sigma}) \, dxdt - \int_{I_t} \gamma \langle \Pi \mathbf{u} - \mathbf{s}, \Pi \boldsymbol{\delta} \mathbf{u} \rangle \, dt = 0 \end{cases} \quad (56)$$

Local space Γ associated with the solution to:

$$\min_{\hat{F}(\boldsymbol{\Sigma}_{ad}^\varphi)=0} \mathcal{E}_\varphi^2(\boldsymbol{\Sigma}_{ad}^\varphi) \quad (57)$$

Stationarity conditions of the associated Lagrangian lead to the following non-linear differential equation:

$$\int_{I_t} \int_{\Omega} \int_0^t \boldsymbol{\delta} \boldsymbol{\sigma} : \left((n_v + 1) \frac{\langle \|\boldsymbol{\sigma}^D\| - (R + R_0) \rangle_+^{n_v+1}}{\|\|\boldsymbol{\sigma}^D\| - (R + R_0)\|} \frac{\boldsymbol{\sigma}^D}{\|\boldsymbol{\sigma}^D\|} - \boldsymbol{\varepsilon}^{vp} \right) d\tau dxdt \quad (58)$$

In practice, time integration for the solution in this local stage is performed using an implicit Euler scheme.

5.2.2. Model updating on a turbine blade

In order to illustrate the model updating using the mCRE in the context of visco-plastic behavior, we address the updating of an external load on a turbine

blade¹. Boundary conditions are classical for this kind of problem: (i) normal displacement set to zero on the blade foot; (ii) body force corresponding to a centrifugal loading.

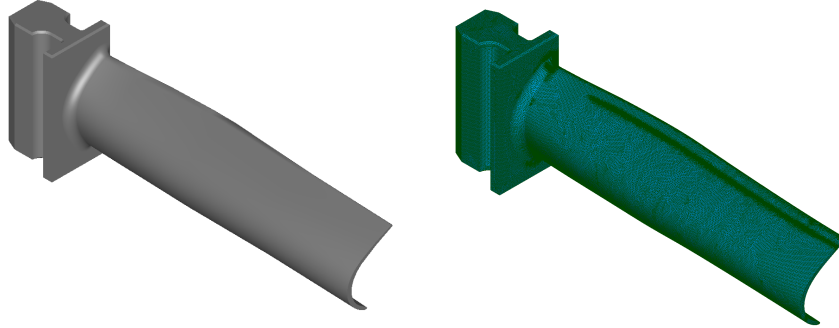

Figure 9: Visco-plastic behavior example - turbine blade geometry (left) and mesh (right)

In order to perform all computations (simulation of observation data and solution to the inverse problem), we used a mesh made of 1,099,544 four-nodes tetrahedra which leads to a 918,000 dofs problem and 4,398,176 integration points. This mesh was created from the Salome software and using the Netgen library; it is represented in Figure 9.

The inverse problem to be solved consists in updating the centrifugal load, defined by the following formula (59) and applied to the blade (only the longitudinal component of the load is considered):

$$f_{centrifugal}(x, y, z, t) = \rho\omega^2 x \cdot t \quad (59)$$

with x the longitudinal space coordinate along the blade. In practice, the parameter to be updated is the angular speed ω .

The material parameters used in this example are given in the Table 2.

Parameter	E	ν	R_0	$k_{hardening}$	n_v	k_v
Value	200 GPa	0.3	400 MPa	10 GPa	7	400

Table 2: Material parameters used for the turbine blade example

First we solve the direct problem in order to simulate observations. We consider 16 displacement sensors, 8 set on the intrado of the blade and 8 set on the extrado. We consider in addition a 1% measurement noise represented by a Gaussian white noise. In Figure 10 we plot the cumulated plasticity at

¹The geometry used for this example comes from the web site Grabcad (www.grabcad.com), represented in Figure 9

different time increments. We observe the classical plasticity profile for this kind of problem, that is a plasticity initiation in the junction between the foot and the body of the blade then a propagation in the blade after some increments.

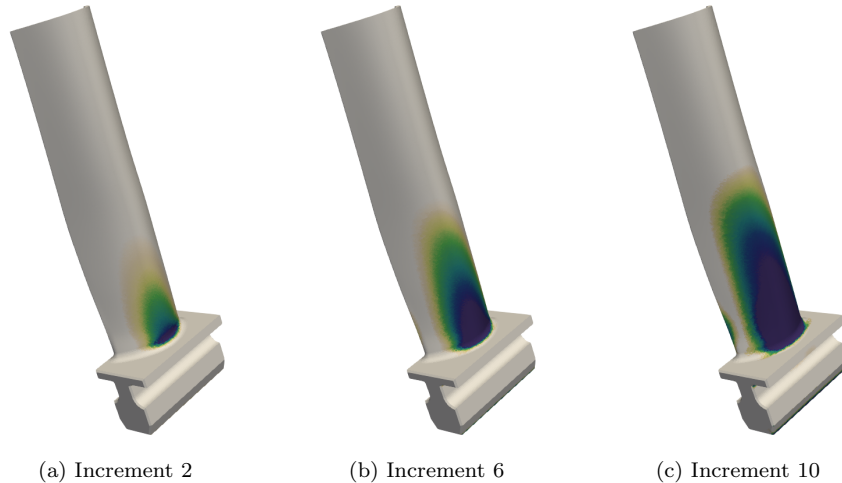

Figure 10: Visco-plastic behavior example — Cumulated plasticity in the blade

In Figure 11 we represent during the iterations of the identification process: (i) the evolution of the mCRE functional; (ii) the evolution of the relative error between the identified parameter ω and the exact one. We observe that the obtained results are very similar to those obtained in the previous example. However, there is a monotonous and very fast decrease of both mCRE functional and relative error on the updated parameter, with only 10 iterations needed for convergence. We can explain this higher convergence speed (compared to the previous example) by the fact that in this case we search to identify a parameter which is more macroscopic. Indeed we consider a global external load parameter that is a really sensitive parameter in the response of the model, in comparison to the previous example where we identified a parameter at the level of the damage law, i.e. a more microscopic scale parameter. At convergence, we obtain a relative error of 1.23% on the parameter, error level that we consider as acceptable given the measurement noise level and the number of sensors considered.

6. Conclusions and prospects

We proposed in this work a general formulation of the concept of modified Constitutive Relation Error applicable for the solution of inverse problems with both linear and nonlinear mechanical behaviors. Based on a sound thermodynamical formulation of the material behavior, the defined mCRE functional has

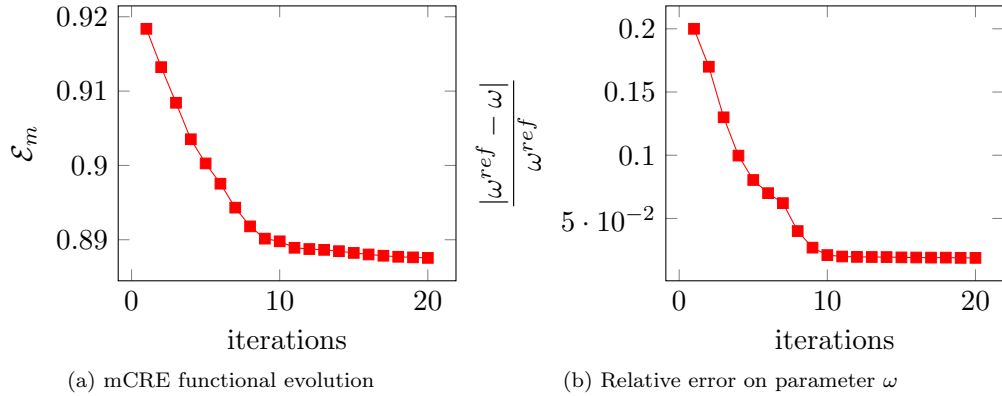

Figure 11: Visco-plastic behavior example - evolution during the iterations of the mCRE functional and of the relative error on the identified parameter

a very strong physical background in comparison to more classical least-square functionals. Furthermore, it is associated with convenient convexity properties inherited from the thermodynamical potentials (provided the large class of materials with standard formulation is considered). We also investigated a dedicated solution strategy based on a splitting of the mCRE functional, in a similar way as in the LaTIn method. We illustrated the approach on two practical examples which confirmed the accuracy and numerical effectivity of the obtained inverse problem solution, even when considering a small number of measurement points and additional measurement noise.

Forthcoming research works are twofold: (i) the use of this general formulation of the modified Constitutive Relation Error in order to extend to nonlinear behaviors the Modified Kalman Filter data assimilation process described in [48]; (ii) the use of model reduction methods, especially the Proper Generalized Decomposition, in order to further speed-up the admissible fields computation step as initially investigated in [12, 15]. A longer term investigation will address problems involving instability phenomena, for which a small value of the error does not necessarily mean that the calculated solution is very close to the exact solution. This last point constitutes a major difficulty and remains an open question in V&V activities.

References

- [1] Allix, O., Deü, J.F., 1997. Delay-damage modelling for fracture prediction of laminated composites under dynamic loading. *Engineering Transactions* 45, 29–46.
- [2] Allix, O., Feissel, P., Nguyen, H., 2005. Identification strategy in the presence of corrupted measurements. *Engineering Computations* 22, 487–504.
- [3] Allix, O., Vidal, P., 2002. A new multi-solution approach suitable for structural identification problems. *Computer Methods in Applied Mechanics and Engineering* 191, 2727–2758.
- [4] Arcangeli, R., 1966. Pseudo solution de l'équation $Ax=y$. *Compte Rendu de l'Académie des Sciences* 263, 282–285.
- [5] Avril, S., Bonnet, M., Bretelle, A.S., Grédiac, M., Hild, F., Ienny, P., Latourte, F., Lemosse, D., Pagano, S., Pagnacco, E., Pierron, F., 2008. Overview of identification methods of mechanical parameters based on full-field measurements. *Experimental Mechanics* 48, 381.
- [6] Azam, S.E., 2014. *Online Damage Detection in Structural Systems*. Springer International Publishing.
- [7] Barbarella, E., Allix, O., Daghia, F., Lamon, J., Jollivet, T., 2016. A new inverse approach for the localization and characterization of defects based on compressive experiments. *Computational Mechanics* 57, 1061–1074.
- [8] Ben Azzouna, M., Feissel, P., Villon, P., 2015. Robust identification of elastic properties using the modified constitutive relation error. *Computer Methods in Applied Mechanics and Engineering* 295, 196–218.
- [9] Bonnet, M., Aquino, W., 2015. Three-dimensional transient elastodynamic inversion using an error in constitutive relation functional. *Inverse Problems* 31, 035010. doi:10.1088/0266-5611/31/3/035010.
- [10] Bonnet, M., Constantinescu, A., 2005. Inverse problems in elasticity. *Inverse Problems* 21, 51–R50.
- [11] Boucard, P.A., Champaney, L., 2003. A suitable computational strategy for the parametric analysis of problems with multiple contact. *International Journal for Numerical Methods in Engineering* 57, 1259–1281.
- [12] Bouclier, R., Louf, F., Chamoin, L., 2013. Real-time validation of mechanical models coupling pgd and constitutive relation error. *Computational Mechanics* 52, 861–883.
- [13] Bui, H., Constantinescu, A., 2000. Spatial localization of the error of constitutive law for the identification of defects in elastic bodies. *Archives of Mechanics* 52, 511–522.

- [14] Cailletaud, G., Pilvin, P., 1994. Identification and inverse problems related to material behaviour. *Inverse Problems in Engineering Mechanics* , 79–86.
- [15] Chamoin, L., Allier, P.E., Marchand, B., 2016. Synergies between the constitutive relation error concept and PGD model reduction for simplified V&V procedures. *Advanced Modeling and Simulation in Engineering Sciences* 3, 1–26.
- [16] Charbonnel, P.É., Ladevèze, P., Louf, F., Noac’h, C.L., 2013. A robust CRE-based approach for model updating using in situ measurements. *Computers & Structures* 129, 63–73.
- [17] Chavent, G., Kunisch, K., Roberts, J., 1996. Primal-Dual Formulations for Parameter Estimation Problems. Research Report RR-2891. INRIA.
- [18] Chen, P., Chen, Y., Rao, M., 2008. Metrics defined by bregman divergences. *Communications in Mathematical Sciences* 6, 915–926.
- [19] Chouaki, A., Ladevèze, P., Proslir, L., 1996. An updating of structural dynamic model with damping. *Inverse Problems in Engineering : Theory and Practice* , 335–342.
- [20] Claire, D., Hild, F., Roux, S., 2004. A finite element formulation to identify damage fields: The equilibrium gap method. *International Journal of Numerical Methods in Engineering* 62, 189–208.
- [21] Constantinescu, A., Tardieu, N., 2001. On the identification of elastoviscoplastic constitutive law from indentation tests. *Inverse Problems in Engineering* 9, 19–44.
- [22] Corigliano, A., Mariani, S., 2001. Parameter identification of a time-dependent elastic-damage interface model for the simulation of debonding in composites. *Composites Science and Technology* 61, 191–203.
- [23] Deraemaeker, A., Ladevèze, P., Romeuf, T., 2004. Model validation in the presence of uncertain experimental data. *Engineering Computations* 21, 808–833.
- [24] Diaz, M.I., Aquino, W., Bonnet, M., 2015. A modified error in constitutive equation approach for frequency-domain viscoelasticity imaging using interior data. *Computer Methods in Applied Mechanics and Engineering* 296, 129–149.
- [25] Faverjon, B., Ladevèze, P., Louf, F., 2009. Validation of stochastic linear structural dynamics models. *Computers & Structures* 87, 829–837.
- [26] Feissel, P., Allix, O., 2007. Modified constitutive relation error identification strategy for transient dynamics with corrupted data: The elastic case. *Computer Methods in Applied Mechanics and Engineering* 196, 1968–1983.

- [27] Florentin, E., Lubineau, G., 2010. Identification of the parameters of an elastic material model using the constitutive equation gap method. *Computational Mechanics* 46, 521–531.
- [28] Foerch, R., Besson, J., Cailletaud, G., Pilvin, P., 1997. Polymorphic constitutive equations in finite element codes. *Computer Methods in Applied Mechanics and Engineering* 141, 355–372.
- [29] Gao, D., 2004. Complementarity, duality and symmetry in nonlinear mechanics, in: *Proceeding of the IUTAM Symposium*, Springer.
- [30] Germain, P., Nguyen, Q.S., Suquet, P., 1983. Continuum thermodynamics. *Journal of Applied Mechanics* 50, 1010–1020.
- [31] Halphen, B., Nguyen, Q., 1975. Sur les matériaux standard généralisés. *Journal de mécanique* 14, 39–63.
- [32] Hamilton, 1994. *Time Series Analysis*. Princeton University Press.
- [33] Huang, S., Feissel, P., Villon, P., 2016. Modified constitutive relation error: An identification framework dealing with the reliability of information. *Computer Methods in Applied Mechanics and Engineering* 311, 1–17.
- [34] Kaipio, J., Somersalo, E., 2006. *Statistical and Computational Inverse Problems*. Applied Mathematical Sciences, Springer.
- [35] Ladevèze, P., 1989a. The large time increment method for the analyze of structures with nonlinear constitutive relation described by internal variables. *Comptes-rendus des séances de l’académie des sciences* , 1095–1099.
- [36] Ladevèze, P., 1989b. On a damage mechanics approach. *Mechanics and mechanisms of damage in composites and multi-materials* , 119–141.
- [37] Ladevèze, P., 1999. *Nonlinear computational structural mechanics: new approaches and non-incremental methods of calculation*. Mechanical engineering series, Springer.
- [38] Ladevèze, P., 2001. Constitutive relation error estimations for finite element analyses considering (visco)-plasticity and damage. *International Journal in Numerical Methods in Engineering* 52, 527–542.
- [39] Ladevèze, P., Chamoin, L., 2015. The constitutive relation error method: a general verification tool. Springer, L. Chamoin & P. Diez Eds.
- [40] Ladevèze, P., Moës, N., 1998. A new a posteriori error estimation for nonlinear time-dependent finite element analysis. *Computer Methods in Applied Mechanics and Engineering* 157, 45–68.
- [41] Ladevèze, P., Nedjar, D., Reynier, M., 1994. Updating of finite element models using vibration tests. *AIAA Journal* 32, 1485–1491.

- [42] Ladevèze, P., Pelle, J.P., 2006. Mastering Calculations in Linear and Non-linear Mechanics. Mechanical Engineering Series, Springer New York.
- [43] Ladevèze, P., Puel, G., Deraemaeker, A., Romeuf, T., 2006. Validation of structural dynamics models containing uncertainties. *Computer Methods in Applied Mechanics and Engineering* 195, 373–393.
- [44] Ladevèze, P., Chouaki, A., 1999. Application of a posteriori error estimation for structural model updating. *Inverse Problems* 15, 49–58.
- [45] Ladevèze, P., Moës, N., Douchin, B., 1999. Constitutive relation error estimators for (visco)plastic finite element analysis with softening. *Computer Methods in Applied Mechanics and Engineering* 176, 247–264.
- [46] Latourte, F., Chrysochoos, A., Pagano, S., Wattrisse, B., 2008. Elastoplastic behavior identification for heterogeneous loadings and materials. *Experimental Mechanics* 48, 435–449.
- [47] Lemaitre, J., Chaboche, J.L., Benallal, A., Desmorat, R., 2009. *Mécanique des matériaux solides-3eme édition*. Dunod.
- [48] Marchand, B., Chamoin, L., Rey, C., 2016. Real-time updating of structural mechanics models using Kalman filtering, modified Constitutive Relation Error and Proper Generalized Decomposition. *International Journal in Numerical Methods in Engineering* 107, 786–810.
- [49] Marigo, J.J., 2002. From Clausius-Duhem and Drucker-Ilyushin inequalities to standard materials, in: Maugin, G., Drouot, R., Sidoroff, F. (Eds.), *Continuum Thermomechanics*. Springer Netherlands. volume 76 of *Solid Mechanics and Its Applications*, pp. 289–300.
- [50] Moreau, J., 1966. Convexity and duality. *Functional Analysis and Optimization* , 145–169.
- [51] Morozov, V.A., 1968. The error principle in the solution of operational equations by the regularization method. *USSR Computational Mathematics and Mathematical Physics* 8, 63–87.
- [52] Moussawi, A., Lubineau, G., Florentin, E., Blaysat, B., 2013. The constitutive compatibility method for identification of material parameters based on full-field measurements. *Computer Methods in Applied Mechanics and Engineering* 265, 1–14.
- [53] Nguyen, H., Allix, O., Feissel, P., 2008. A robust identification strategy for rate-dependent models in dynamics. *Inverse Problems* 24, 065006.
- [54] Strohmaier, E., Dongarra, J., Simon, H., Meuer, M., 2018. Top 500 super-computer list. <https://www.top500.org>.
- [55] Tarantola, A., 2005. *Inverse Problem Theory and Methods for Model Parameter Estimation*. Society for Industrial and Applied Mathematics.

- [56] Tikhonov, A., Arsenin, Y., 1977. Solutions to ill-posed problems. Wintson-Widley, New-York.
- [57] Vigliotti, A., Csányi, G., Deshpande, V., 2018. Bayesian inference of the spatial distributions of material properties. *Journal of the Mechanics and Physics of Solids* 118, 74–97.