



HAL
open science

Competing growth of titanium nitrides and silicides in Ti thin films processed in expanding microwave plasma: Morphology and microstructural properties

Isabelle Jauberteau, Pierre Carles, Richard Mayet, Julie Cornette, Annie Bessaudou, Jean Louis Jauberteau

► **To cite this version:**

Isabelle Jauberteau, Pierre Carles, Richard Mayet, Julie Cornette, Annie Bessaudou, et al.. Competing growth of titanium nitrides and silicides in Ti thin films processed in expanding microwave plasma: Morphology and microstructural properties. AIP Advances, 2018, 8 (9), pp.095105. 10.1063/1.5035188 . hal-01875229

HAL Id: hal-01875229

<https://hal.science/hal-01875229v1>

Submitted on 17 Sep 2018

HAL is a multi-disciplinary open access archive for the deposit and dissemination of scientific research documents, whether they are published or not. The documents may come from teaching and research institutions in France or abroad, or from public or private research centers.

L'archive ouverte pluridisciplinaire **HAL**, est destinée au dépôt et à la diffusion de documents scientifiques de niveau recherche, publiés ou non, émanant des établissements d'enseignement et de recherche français ou étrangers, des laboratoires publics ou privés.

Competing growth of titanium nitrides and silicides in Ti thin films processed in expanding microwave plasma: Morphology and microstructural properties

Isabelle Jauberteau, Pierre Carles, Richard Mayet, Julie Cornette, Annie Bessaudou, and Jean Louis Jauberteau

Citation: *AIP Advances* **8**, 095105 (2018); doi: 10.1063/1.5035188

View online: <https://doi.org/10.1063/1.5035188>

View Table of Contents: <http://aip.scitation.org/toc/adv/8/9>

Published by the [American Institute of Physics](#)

Articles you may be interested in

[Studies of MCP-PMTs in the miniTimeCube neutrino detector](#)

AIP Advances **8**, 095003 (2018); 10.1063/1.5043308

[Research on the selective adhesion characteristics of polydimethylsiloxane layer](#)

AIP Advances **8**, 095004 (2018); 10.1063/1.5041867

AIP | Conference Proceedings

Get **30% off** all
print proceedings!

Enter Promotion Code **PDF30** at checkout



Competing growth of titanium nitrides and silicides in Ti thin films processed in expanding microwave plasma: Morphology and microstructural properties

Isabelle Jauberteau,^{1,a} Pierre Carles,¹ Richard Mayet,¹ Julie Cornette,¹ Annie Bessaudou,² and Jean Louis Jauberteau¹

¹Faculté des Sciences et des Techniques, Université de Limoges, CNRS, IRCER, UMR 7315, CEC, 12 rue Atlantis, F-87068 Limoges, France

²Faculté des Sciences et des Techniques, Université de Limoges, CNRS, XLIM, UMR6172, 123 av. A. Thomas, F-87060 Limoges, France

(Received 13 April 2018; accepted 29 August 2018; published online 10 September 2018)

The diffusion of nitrogen into Ti silicide films allows the performance of complementary metal oxide semiconductor (CMOS) components to be improved. In this work, the thermochemical treatment is carried out in an expanding microwave plasma reactor using (Ar-33%N₂-1%H₂) gas mixtures. This process promotes the chemical reactions on the surface of metals. The diffusion of nitrogen into the film is improved by the reducing effect of NH_x and/or H species towards passive layers such as oxides which form a barrier of diffusion in the surface layers during the process. The simultaneous formation of Ti nitrides and silicides at the surface and at the film-substrate interface, respectively gives rise to two competing processes which result in the growth of the Ti nitride phase at the expense of the Ti silicide phase at a critical temperature of 800°C. This paper reports on a comprehensive analysis of the evolution of TiSi₂ and TiN phases and microstructural properties of films by means of X-ray diffraction, Raman spectroscopy, transmission electron microscopy and selected area electron diffraction investigations. Square shaped crystals of TiN are identified on the top of round shaped crystals of TiSi₂. The growth of the TiN phase at the expense of TiSi₂ induces a catastrophic decrease of the intensity of the (040) diffraction line of TiSi₂ and a huge increase of the (220) reflection line of TiN. The microstructural properties changes during the process such as the formation of TiN crystals of nanometric size in the bulk of the TiSi₂ phase as well as the migration of free Si which epitaxially grows at the film-substrate interface have been evidenced by very detailed investigations for the first time. The results are related to the mechanism of formation of TiN from the reaction between TiSi₂ and nitrogen. © 2018 Author(s). All article content, except where otherwise noted, is licensed under a Creative Commons Attribution (CC BY) license (<http://creativecommons.org/licenses/by/4.0/>). <https://doi.org/10.1063/1.5035188>

I. INTRODUCTION

Refractory transition metal silicides are well known for applications such as contacts and sub-micrometer gate source and drain areas in complementary metal oxide semiconductor technology (CMOS). They exhibit high temperature stability, low resistivity, chemical compatibility, electron migration resistance and low Schottky barrier height. Among them, the TiSi₂ compound has been extensively studied in the 80s-90s because it shows the lowest resistivity equal to 15 μΩcm, it can be self-aligned to form Al/TiSi₂/Si contact systems and it is easily synthesized by rapid thermal annealing (RTA) of Ti films coated on Si substrates.¹⁻¹⁰

Because of the great reactivity of Ti, the Ti-Si reaction is very complex, and it extends both in the growth direction and laterally. The lateral growth of TiSi₂ induces shorting between gate and

^aElectronic mail: isabelle.jauberteau@unilim.fr

source-drain regions which results in low yield for applications to CMOS. RTA conducted in ambient nitrogen purges the process from detrimental impurities and improves the technological performances of TiSi_x/Si systems.^{1,3,8,11,12}

TiN films deposited on TiSi_x/Si systems are efficient barriers for outward and inward diffusion of species that drastically reduces the lateral silicide formation. In a recent article, it has been shown that nitrogen diffusing into TiSi_2 from the as-deposited TiN film allows the barrier height of TiSi_2/Si Schottky diodes to be reduced by 80 meV and about 15% of self-power consumption is saved.⁹

In contrast with Ti silicides, Ti nitrides have been more recently studied.^{13–19} TiN exhibits a resistivity of $30 \mu\Omega\text{cm}$ combined with a high melting point of 2947°C , extreme hardness, high thermodynamic stability, low friction constant, high wear and corrosion resistance. Owing to its very interesting properties, TiN is used as a diffusion barrier, gate material, Schottky barrier contact, capacitor electrode and transistor gate electrodes.¹⁵ Ti nitride thin films are usually synthesized by various processes such as DC or RF magnetron sputtering^{13–15} or pulsed laser irradiation.^{16,17,19,20}

In this work, TiN is formed during a thermochemical process using expanding plasma produced by a microwave discharge at a frequency of 2.45 GHz. The higher degree of ionization and dissociation which can be obtained makes the microwave plasma very interesting compared to other types of electrical excitations.

In a recent paper,²¹ we reported the various Ti silicides formed during the Ti-Si interaction in Ti thin films coated on Si (100) substrates exposed to $(\text{Ar-N}_2\text{-H}_2)$ expanding plasma. The results have mainly shown the crystallization of TiSi and C49 TiSi_2 at 500°C and C54 TiSi_2 at 600°C . TiSi crystallizes in an orthorhombic structure whereas TiSi_2 crystallizes either in the base-centred orthorhombic structure named C49 structure or the face-centred orthorhombic structure named C54 structure. Both structures have the same crystallographic arrangement in the plane but they only differ from different stacking arrangements.⁶ Other metal rich silicides such as Ti_5Si_3 or Ti_5Si_4 , have also been identified in other works, at the start of Ti-Si reaction.²² The composition of various TiSi phases as well as their sequence depends on the nature of Si substrates (amorphous or crystallized) and on kinetic factors.

In the same paper,²¹ we have also reported that nitrogen produced in the plasma starts to diffuse into Ti films at 400°C , TiN is synthesized as an amorphous structure at 600°C and starts to crystallize into a cubic structure at 800°C . So, two simultaneous reactions proceeding in opposite directions occur in Ti films heated in the temperature range from 400 to 800°C and exposed to $(\text{Ar-N}_2\text{-H}_2)$ expanding plasma, which are the formation of Ti silicides from the Ti-Si interface and on the other hand, the formation of Ti nitrides from the Ti film surface. The growing TiSi_2 and TiN compounds are expected to interact and the result depends on both thermodynamic and kinetic factors. According to thermodynamic data, the formation of TiN must be promoted since the enthalpies of formation of TiN and TiSi_2 are equal to -337.45 and $-134.11 \text{ kJmol}^{-1}$, respectively.²³ Some studies report that the nitride phase modifies the kinetic of the formation of silicides.³ The diffusion of nitrogen into Ti silicides has also been observed in various works.^{11,9}

The reaction at the Ti-Si interface, the nucleation and growth of various Ti silicides as well as their morphologies and crystal structures have been widely investigated.^{4–6,10,12,24} However, to our knowledge, only very few studies report on the morphology and crystalline structure of Ti silicides and nitrides when they interact. Moreover, they are not as detailed as in the present work, which is mainly focused on the microstructure, morphology and crystallization of Ti silicides and nitrides during the growth of Ti nitrides.

In the light of results obtained from X-ray diffraction (XRD), Raman measurements and very detailed studies of microstructures and crystalline structures obtained by transmission electron microscopy (TEM) and selected area electron diffraction (SAED), some attempts are made to improve the understanding of the mechanism of formation of TiN in TiSi_2 thin films.

II. EXPERIMENT

The nitriding thermochemical treatments are carried out in expanding plasma produced by a microwave discharge in a mixture of argon, nitrogen and hydrogen gas.

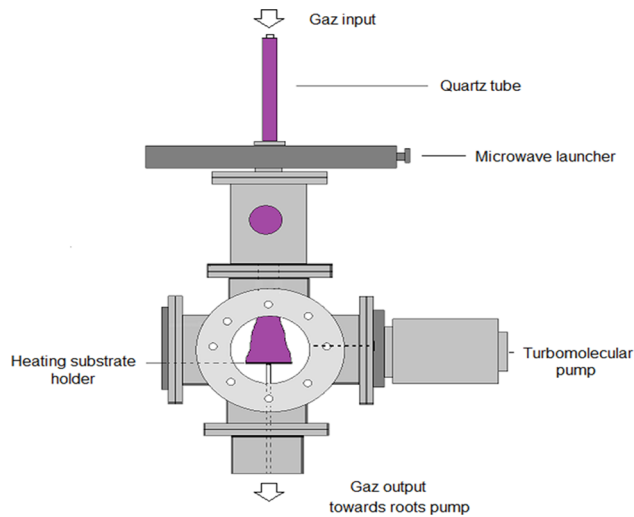

FIG. 1. Experimental set-up.

The reactor consists of a fused silica tube (external and internal diameter of 24 and 20 mm, respectively) passing through the surface wave launcher and welded to a cylindrical metallic chamber (Figure 1). The base pressure is maintained at 10^{-5} Pa by means of a turbomolecular pump. During the plasma treatment, the total pressure of 0.13 kPa is kept constant using an Alcatel roots blower pump ($70\text{--}700\text{ m}^3\text{h}^{-1}$) with a corresponding gas drift velocity of about 20 ms^{-1} .

The microwave discharge is produced in the gas mixture at a frequency of 2.45 GHz using the power supply SAIREM GMP 12 kE operating up to 1.2 kW. The power of the discharge is mainly transferred to the electrons and then to other gaseous species by inelastic collisions. Once the plasma is ignited, it is expanded out of the centre of the discharge up to the surface of the substrate under conditions of large density of electrons. The critical value depends on both plasma conditions i.e. collision or collision less plasma and microwave frequency. Since the plasma frequency is larger than the electromagnetic wave frequency, the electromagnetic wave is reflected by the plasma. So, the plasma is produced by a surface wave which propagates into the reactor along the external surface of the plasma.²⁵ These conditions are realized in the quartz tube and at the tube exit. The plasma forms a bright cone from the quartz tube exit up to the surface of the substrate (Fig. 1). The electron density in (Ar-33%N₂-1%H₂) ranges between 0.03 and $0.15 \times 10^{16}\text{ m}^{-3}$ and the electron energy ranges between 0.51 and 1.37 eV. These values have been measured along the vertical axis of the reactor in the vicinity of the substrate surface.²⁵ The density and energy of the plasma are homogeneous above the surface of the substrate.

In most of plasma treatments, the impinging energetic ions improve the nitrogen transfer into the metal films by sputtering the passive layers such as carbides and oxides. In our process, since the ion energy at the sheath entrance is only equal to about 0.1 eV, the reducing effect of passive layers are mainly due to plasma species such as NH_x radicals and/or H atoms produced in (Ar-N₂-H₂) plasma. They promote the diffusion of nitrogen into the metal films and then the formation of nitrides by reducing oxides and carbides which form a barrier of diffusion in the film surface layers during the nitriding process. Such an effect has been evidenced during the formation of Mo nitrides.²⁵

Ti thin films are evaporated on Si (100) wafers under Ar gas at a pressure of 0.5 Pa in an electron beam evaporator using pure titanium cylinder and pellets (99.95%). The wafers are biased at -400 V and heated at 400°C which allows the surface to be cleaned by the impinging ions and improves the adhesion of Ti films. Substrates of size $10 \times 10\text{ mm}^2$ are obtained by cutting titanium films, 250 nm or 500 nm thick coated on Si wafers. They are then placed on the heating substrate holder at 12.5 cm from the centre of the discharge. The vacuum chamber is evacuated to a pressure of 10^{-5} Pa and the heating switched on. After heating to 800°C, the (Ar-33%N₂-1%H₂) gas mixture is introduced into the reactor. The contents are expressed as a percentage of the total volume of gas. The discharge is

produced with a power of about 500 W. The total pressure is equal to 0.13 kPa. Such parameters have been optimized in our previous study.²¹ The experiments are run for 3, 6, 12 and 18 h.

The processed Ti films are then examined by X-ray diffraction (XRD) and Raman spectrometry to determine the phase composition as well as the crystal structures of compounds. The structure of the film and the crystalline phases as well as the grain interfaces and microstructures are analysed by transmission electron microscopy (TEM) and selected area electron diffraction (SAED).

For XRD analyses, the classical Bragg-Brentano geometry is carried out on a D8 Advance Bruker diffractometer operating with a primary monochromator to select $\text{CuK}\alpha 1$ radiation and a Lynx-eye position sensitive detector (3.4° for fast acquisition).

A Horiba-Jobin-Yvon spectrometer T 64000 model is used for Raman experiments. This system is equipped with a CCD camera cooled by a flux of liquid nitrogen up to 140 K in order to reduce the thermal noise. An Ar^+ ion laser of excitation wavelength equal to 514.532 nm is focused on to the samples via x50-long working distance objective that results in a spot of diameter equal to 1 mm. The power of the laser is modified to prevent the sample from any damage. The spectra are averaged to make the signal intensities representative of the sample.

Samples for transmission electron microscopy analysis are prepared by mechanical polishing and subsequently thinned by argon ion milling. The investigations are carried out at an accelerating voltage of 200 kV in a JEOL 2100F transmission electron microscope.

III. RESULTS AND DISCUSSIONS

In what follows, the growth of the TiN phase at the expense of TiSi_2 is well evidenced by XRD and Raman spectroscopy measurements. TEM as well as SAED investigations conducted on Ti films processed for durations corresponding to three different key-stages of the growth of TiN allowed the morphology and microstructure of films to be described in detail. The crystalline structures of TiN and TiSi_2 during the growth of TiN are also studied. To our knowledge, such detailed analysis of the structure of TiN- TiSi_2 films has not been reported up to now. Due to these results, an attempt to improve the understanding of the mechanism of reaction leading to the gradual conversion of the TiSi_2 phase into TiN has been made.

A. Early stages of the growth of TiN in TiSi_2

1. Microstructural properties of TiSi_2 films processed for 1h

A TEM cross section of the titanium silicide phase which is formed in Ti films, 500 nm thick heated at 800°C and exposed to ($\text{Ar}-33\%\text{N}_2-1\%\text{H}_2$) plasma for 1h is displayed in Fig. 2(a), (b) and (c).

The titanium silicide film exhibits a rather columnar structure in the direction of growth. Owing to the large size of crystallites ranging from 200 to 500 nm, the film appears rather rough. Its thickness is found to vary from 850 nm to about 1 μm . Such values have been previously measured by secondary ion mass spectrometry (SIMS).²¹ The film-substrate interface appears slightly wavy-like within a scale of micrometers. Many bubble-like inclusions of various dimensions are clearly visible in the whole thickness of the film. Such features have been previously reported.^{11,26} They are supposed to be gas inclusions which are formed during sputter deposition of Ti on Si substrates.²⁶

In what follows, the phase identification is performed on selected area electron diffraction (SAED) patterns by comparing the measured d spacing with the values reported in the corresponding JCPDS cards. The angles between the corresponding diffraction vectors are compared with the calculated values. The SAED patterns (d) and (e) in Fig. 2 have been taken on both sides of the film-substrate interface (Fig. 2(b) and (c), respectively). The pattern (d) taken above the interface is typical of the Si (100) substrate. The incident electron beam is parallel to the [011] crystallographic direction which is the zone axis i.e., the (011) plane of the crystal is observed under these conditions. Si is also identified in a region located below the interface where fine-grained structures are seen (Fig. 2(c)). The low index single crystal region of the corresponding SAED pattern (e) is the same as the pattern of Si substrate (d) although the spots seem to be duller than in (d) especially the higher index region. However, in contrast with SAED pattern (d), additional much brighter spots are identified which correspond to the [040] reflection of TiSi_2 . Tiny spots of larger d_{hkl} correspond to the [111] reflection of TiSi_2 . TiSi_2 crystals growing from the interface seem to be mainly oriented along the

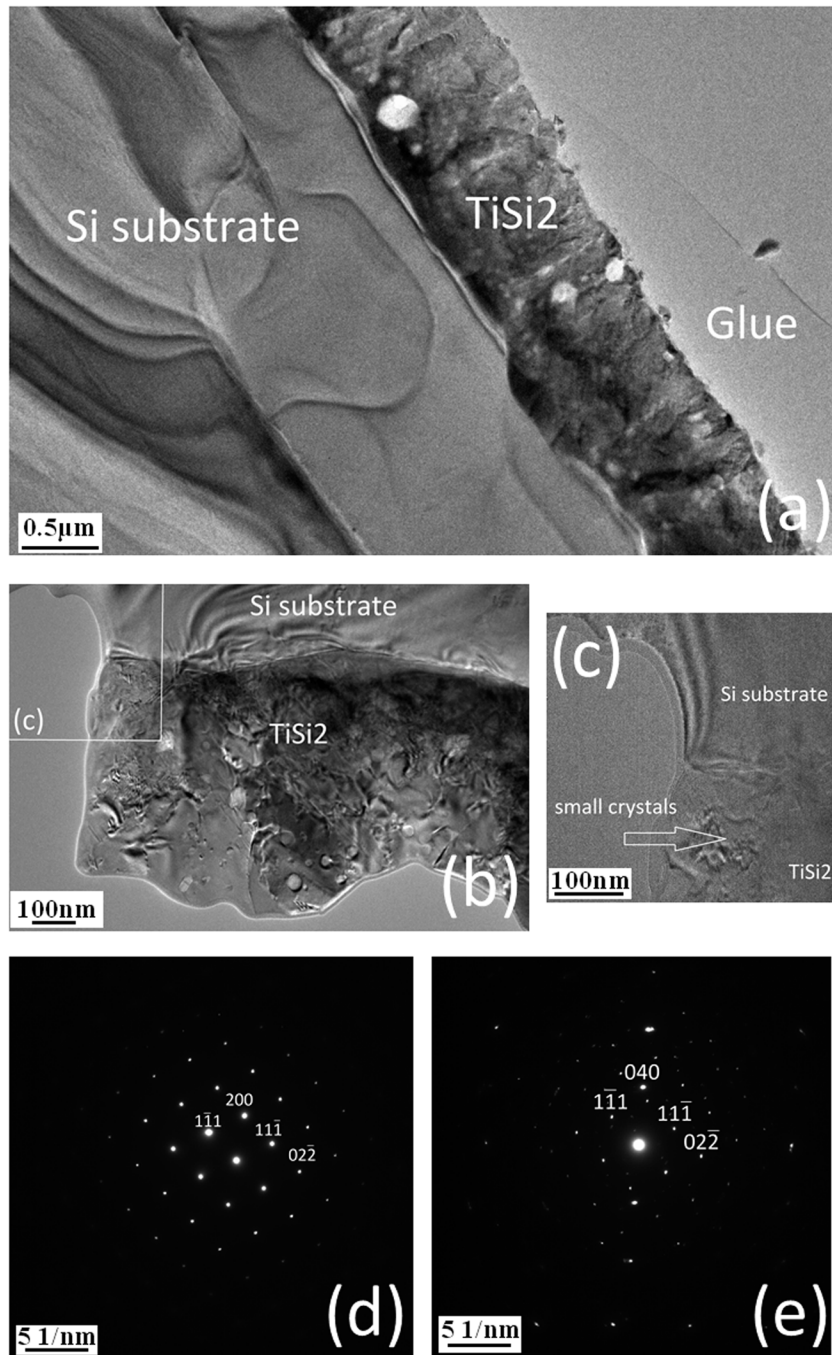

FIG. 2. Cross-sectional transmission electron micrographs of the Ti film 500 nm thick heated at 800°C and exposed to (Ar-33%N₂-1%H₂) plasma for 1 h (a), (b), (c). SAED patterns taken above the interface Si substrate-film (d), and below the interface Si substrate-film (e).

[040] crystallographic direction which is parallel to the (200) plane of Si with a small misorientation of about 8°. These results agree with XRD measurements performed on Ti films of lower thickness since TiSi₂ crystallites show (040) preferred orientations in Ti films, 250 nm thick.²¹ The presence of small grains of Si below the substrate-film interface is consistent with the expected mechanism of formation of silicides. A strong intermixing of Ti and Si occurs during the Ti-Si reaction and Si is usually reported to be the dominant diffusing species.^{3,22} Si diffuses across Ti grain boundaries

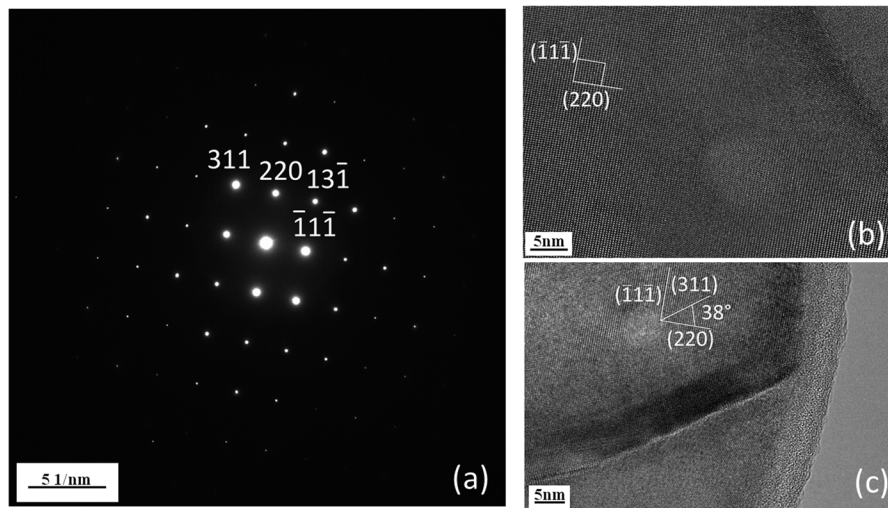

FIG. 3. SAED pattern taken in the vicinity of the film surface (a). HRTEM micrographs of the TiSi_2 crystals viewed along the $[-112]$ direction (b) and (c).

to form fine-grained silicide precursors such as TiSi , Ti_5Si_3 or Ti_5Si_4 before they are transformed into TiSi_2 of larger grain size at high temperatures. Si is also expected to form islands in the grain boundaries which compete with silicide nucleation.²⁷ The SAED pattern (a) in Fig. 3 has been taken from a grain located at the surface of the film. It has been identified as the orthorhombic C54TiSi_2 phase with the $[-112]$ zone axis.

A similar pattern has been found in another region of the film which confirms that the film mainly consists of C54 TiSi_2 crystallites. Such results have been previously obtained from TiSi_2 films made by annealing Ti thin films, 100 nm thick in vacuum at 800°C for 1h.¹⁰ The thin amorphous phase observed at the metal surface corresponds to the growing TiN phase which has been amorphized during the cross-sectional preparation for TEM observations (Fig. 2(a) and (b)) since XRD measurements performed on Ti films processed under the same experimental conditions showed that TiN starts to crystallize at 800°C .²¹ A high resolution TEM (HRTEM) image of a TiSi_2 crystal (b) is displayed in Fig. 3. The angle between $(-11-1)$ and (220) planes is equal to 90° which agrees with the calculated value. A bubble-like inclusion is clearly identified on the micrograph and seems to belong to the crystal lattice rather than to be a gas inclusion. The grain boundary shown in Fig. 3(c) is oriented along the (311) plane of TiSi_2 .

B. Growth of the TiN phase at the expense of TiSi_2

1. XRD and Raman spectroscopy investigations

Long treatment durations up to 18h have been conducted to show the growth and crystallization of TiN phase at the expense of TiSi_2 .

Ti films, 250 nm thick heated at 800°C and exposed to $(\text{Ar}-33\%\text{N}_2-1\%\text{H}_2)$ plasma for 3 h consist almost entirely of C54 TiSi_2 crystallites of face-centred orthorhombic structure (JCPDS card no. 00-035-0785). The corresponding XRD pattern (a) in Figure 4 mainly displays the most intense (311) , (040) , (022) and (331) reflection lines at Bragg angles of 39.2° , 42.3° , 43.3° and 49.9° , respectively. Other lines of lower intensity at Bragg angles of 23.8° , 30.1° and 38.3° are assigned to (111) , (220) and (131) reflection lines of the C54TiSi_2 phase. The sharp peak at 33° corresponds to the forbidden (200) reflection of the Si substrate. Since the diffraction lines are very thin and intense, the TiSi_2 phase consists of large crystallites which exhibit a (040) preferred orientation. Similar features have been observed in Ti films processed at 600°C and 800°C for 30 min and 1h.²¹ The XRD features detected at Bragg angles of 36.8° and 42.6° are assigned to the most intense (111) and (200) reflection lines of the TiN phase of cubic structure which starts to crystallize at 800°C (JCPDS card no. 04-004-2917).

The XRD pattern (b) in Figure 4 clearly displays that the intensity ratio of (hkl) TiN to (hkl) TiSi_2 reflection lines strongly increases with increasing plasma exposure from 3 to 6h. A further increase

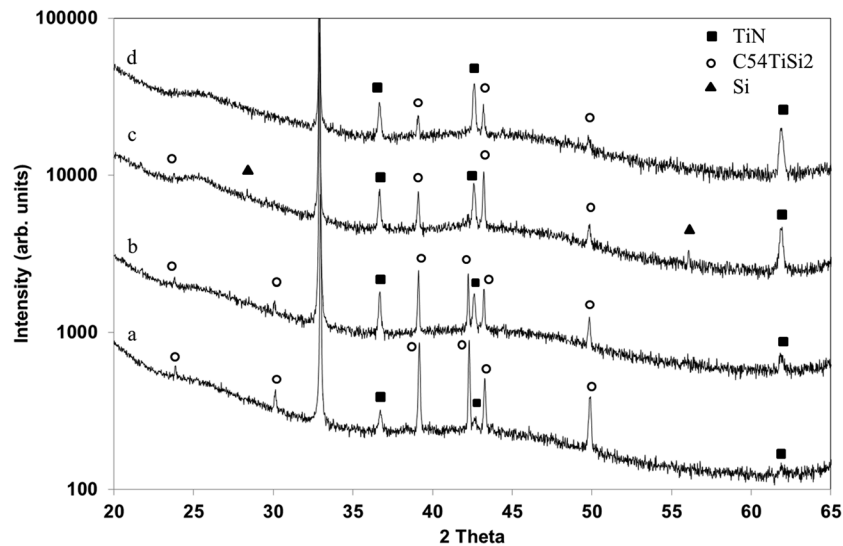

FIG. 4. X-ray diffraction patterns of Ti films, 250 nm thick heated at 800°C and exposed to (Ar-33%N₂-1%H₂) plasma for 3 h (a), 6 h (b), 12 h (c) and 18 h (d).

of the treatment duration from 6 to 12h leads to a catastrophic decrease of the intensity of the (040) TiSi₂ line and a huge increase of the (022) TiN line at Bragg angle equal to 62° (Fig. 4(c)). The (040) preferred orientation of the crystallites has been assigned to stresses occurring in such thin films.^{7,28} Very intense (040) peaks have been observed on XRD patterns corresponding to Ti films, 100 nm thick annealed at 800°C using microwave hydrogen plasma⁷ and Ti films, 55 nm thick processed under various conditions.²⁸ According to the authors, the formation of silicides in metal films coated on Si substrates leads to compressive stresses and the elastic constants are higher in the [010] direction. The preferred orientation of C54 TiSi₂ crystallites is [311] for Ti thick films and [010] for very thin films. In the light of these data, the strong decrease of intensity of the [040] reflection of TiSi₂ crystallites can be related to the growth of the TiN phase at the expense of TiSi₂ which induces an evolution of stresses in the film. The stresses must also play a role in the preferred orientation of TiN crystallites in the [220] direction when the film almost entirely consists of TiN. Further investigations are needed to confirm this result. It is worth noting that, the formation of epitaxial TiN thin films on Si (001) substrates by laser molecular-beam epitaxy technique has been reported in a recent work.²⁹ XRD patterns also show that the reflection lines corresponding to TiN are thin and intense that means that the TiN phase is well-crystallized and consists of large grains as the TiSi₂ phase. A plasma exposure of 18 h leads to the vanishing of the (040) line. Only the most intense (311), (022) and (311) reflection lines still remain on the XRD pattern (d) in Figure 4 and the intensity ratio of (hkl) TiN to (hkl) TiSi₂ reflection lines is now larger than 1.

Compared to (b) and (d), the XRD pattern (c) in Figure 4 displays two additional peaks of low intensity at Bragg angles of 28.5° and 56.1°. They correspond to intense (111) and (311) reflection lines of polycrystalline Si compound (JCPDS card no. 04-001-7247) which could be produced with TiN from the reaction between TiSi₂ and nitrogen. This result will be clarified in next sections. Raman spectroscopy measurements confirm the XRD results. The intensity of the Raman features due to acoustic and optic transitions of TiN increases with increasing treatment duration (Figure 5(a), (b) and (c)). The broad feature around 198 cm⁻¹ is composed of the band due to the acoustic mode of TiN at 215 cm⁻¹ and two Raman bands of C54 TiSi₂ at 196 and 206 cm⁻¹. These TiSi₂ Raman bands are clearly displayed in Ti films before TiN crystallizes.²¹ This broad Raman feature shifts towards higher frequencies with increasing treatment duration (Fig. 5(b) and (c)). In the same way, the intensity of the bands related to acoustic modes of TiN at 320 and 461 cm⁻¹ as well as the intensity of the main Raman band of TiN due to the optic mode at 556 cm⁻¹ increase with increasing treatment duration. The sharp peak at 521 cm⁻¹ displayed on spectrum (a) is due to the Si wafer. It disappears with increasing amounts of TiN.

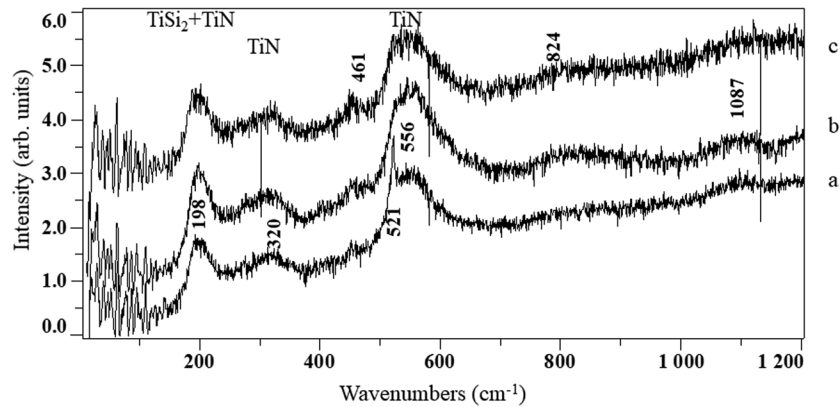

FIG. 5. Raman scattering spectra of Ti films, 250 nm thick heated at 800°C and exposed to (Ar-33%N₂-1%H₂) plasma for 6 h (b) and 12 h (c) compared with Ti films 250 nm thick processed for 3 h (a).²¹

Moreover, the second order spectra which can be identified as small humps at high frequency equal to 824 and 1100 cm⁻¹ confirm the formation of the well-crystallized TiN phase.

2. Microstructural properties of TiN and TiSi₂ phases in films processed for 6h

As seen on electron micrographs (a) and (b) in Fig. 6, Ti films, 250 nm thick heated at 800°C and exposed to (Ar-33%N₂-1%H₂) plasma for 6 h consist of two distinct layers.

The layer close to the surface is formed of many square-shaped crystals of various sizes from about 50 to 100 nm large whereas the layer adjacent to the Si substrate is formed of rather large and round-shaped crystals which can be about 300 nm large. The thickness of the film varies from 400 to 500 nm. Owing to the shape and large size of crystals, the morphology of the film-substrate interface, the surface of the film as well as the interface between both phases are rough on a micrometer scale. The SAED pattern (c) in figure 6 taken on round-shaped crystals is identified as the orthorhombic C54 TiSi₂ phase. However, in contrast with the film processed for 1 h and mainly consisting of TiSi₂ crystals oriented along their [-112] zone axis, the film processed for 6 h consists of TiSi₂ crystals oriented along their [-1-14] zone axis. A crystal located in another region of the film has

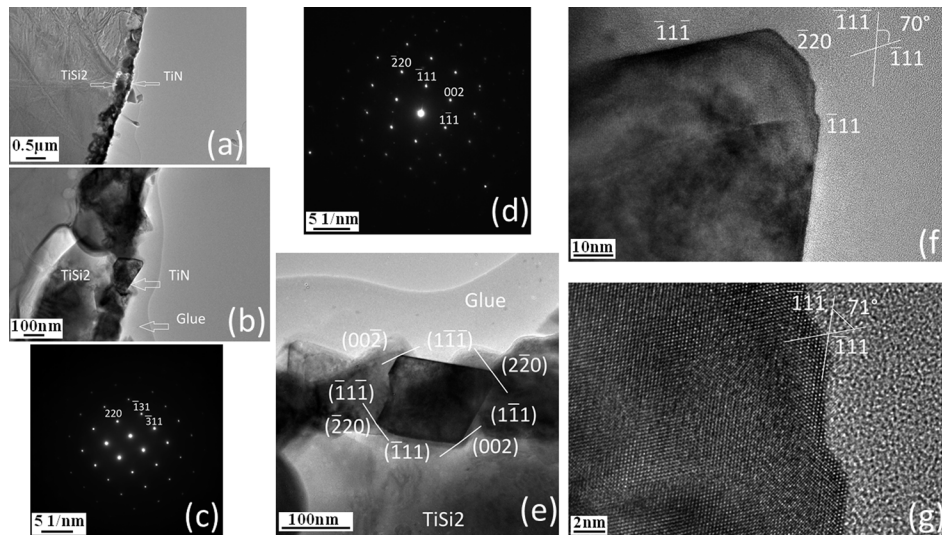

FIG. 6. Electron micrographs of Ti films heated at 800°C and exposed to (Ar-33%N₂-1%H₂) plasma for 6 h (a) and (b). SAED patterns of TiSi₂ crystal (c) and TiN crystal (d). HRTEM electron micrographs of cubic shaped TiN crystal viewed along the [110] direction (e) and growth steps formed by zigzag {111} facets in the [220] direction of TiN crystal (f) and (g).

been found to be oriented along another zone axis. The SAED pattern (d) has been taken on a crystal of the phase close to the surface of the film. It is identified as the TiN phase of cubic structure. The additional tiny spots hardly visible on the SAED pattern correspond to crystals of TiN located nearby. It is worth noting that all patterns corresponding to TiN crystals are similar which means that in contrast with TiSi_2 crystals, TiN crystals exhibit the same $[110]$ zone axis. Since TiN crystals are usually oriented along the $[110]$ direction, they tend to display a flattened morphology with the $[110]$ direction perpendicular to the flat surface (micrograph (e) in Fig. 6). High resolution micrographs (f) and (g) shows that the $\{220\}$ facets of the TiN crystal show growth steps in the form of wavy-shaped edges on nanometer scale which consists of (-111) and $(-11-1)$ atomic planes. So, the TiN (110) plane is expected to consist of growth steps in $[220]$ direction formed with zigzag $\{111\}$ facets in 3 dimensions. Such growth steps morphology has been reported in a previous work on Pt (110) .³⁰ The morphology of the film appears quite heterogeneous since beside TiSi_2 and TiN crystals, other structures of lighter colour and large dimensions either located close to the film-substrate interface or crossing the film are observed on electron micrographs (a) and (b) in Fig. 6.

The structure crossing the film seems to consist of small square-shaped crystals embedded in a gangue of lighter colour (Fig. 7(a)). The corresponding SAED pattern (b) in Fig. 7 only displays tiny spots which can nevertheless be identified as cubic TiN phase. These results show that small TiN crystals of nanometer size are mixed to form a round-shaped structure. Since Si is more transparent in electron beam than TiN and TiSi_2 crystals and so appears with lighter colour on electron micrographs, this structure probably also consists of amorphous Si. It can also be noticed that TiSi_2 crystals located near the mixture of TiN crystals of nanometric size and easily recognizable from their round-shaped morphology seem compressed and buckled. This phenomenon could be related to the mechanism of formation of TiN phase from TiSi_2 crystals and nitrogen. Nitrogen diffuses from the surface into the TiSi_2 film through grain boundaries where it reacts with TiSi_2 that promotes the formation of TiN. The Si is released during the reaction and the TiN phase crystallizes into small crystals oriented along their $[110]$ zone axis then displaying a square-shaped morphology. Since, the whole structure has grown inside TiSi_2 crystals grain boundary, it could have a strong effect on the morphology and orientation of TiSi_2 crystals. In the same way, the structures of lighter and bright colour identified at the film-substrate interface could be the remaining Si which segregates at the surface of Si substrate.

The HRTEM micrographs (c), (d) and (e) in Fig. 7 display the Si- TiSi_2 and TiSi_2 (oriented)-TiN and TiSi_2 -TiN(oriented) interfaces, respectively. They exhibit a flat and smooth morphology. The

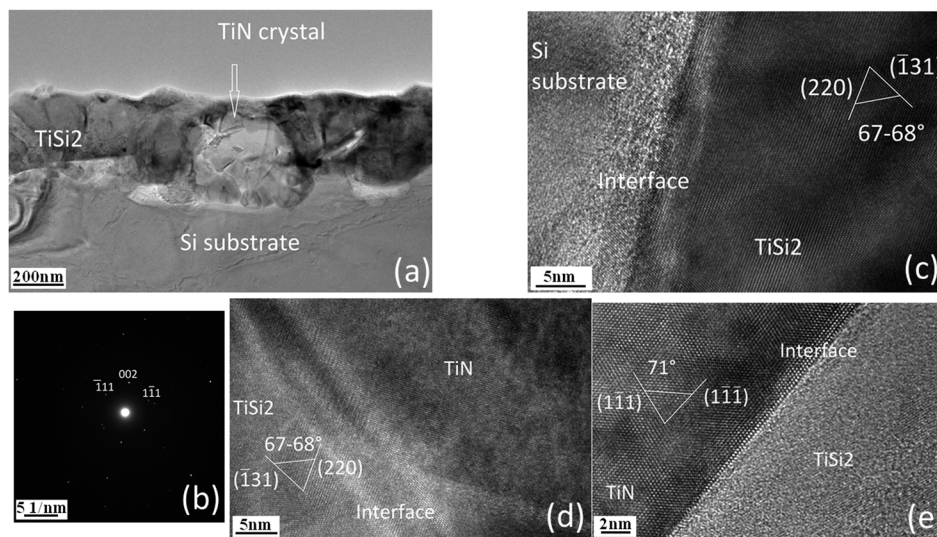

FIG. 7. Electron micrograph of Ti film heated at 800°C and exposed to $(\text{Ar}-33\%\text{N}_2-1\%\text{H}_2)$ plasma for 6 h (a). SAED pattern of the structure indicated by the white arrow (b). HRTEM electron micrographs of Si substrate- TiSi_2 interface (c), TiN- TiSi_2 interface (TiSi_2 is oriented) (d), and TiN- TiSi_2 interface (TiN is oriented) (e).

micrographs (c and d) clearly display the (220) and (-131) atomic planes of TiSi_2 with an interplanar angle of about 67° in agreement with the calculated value. The TiSi_2 crystal is oriented along its $[-11-4]$ zone axis. The (1-1-1) atomic plane of the TiN crystal is adjacent to the TiSi_2 -TiN interface in Fig. 7(e).

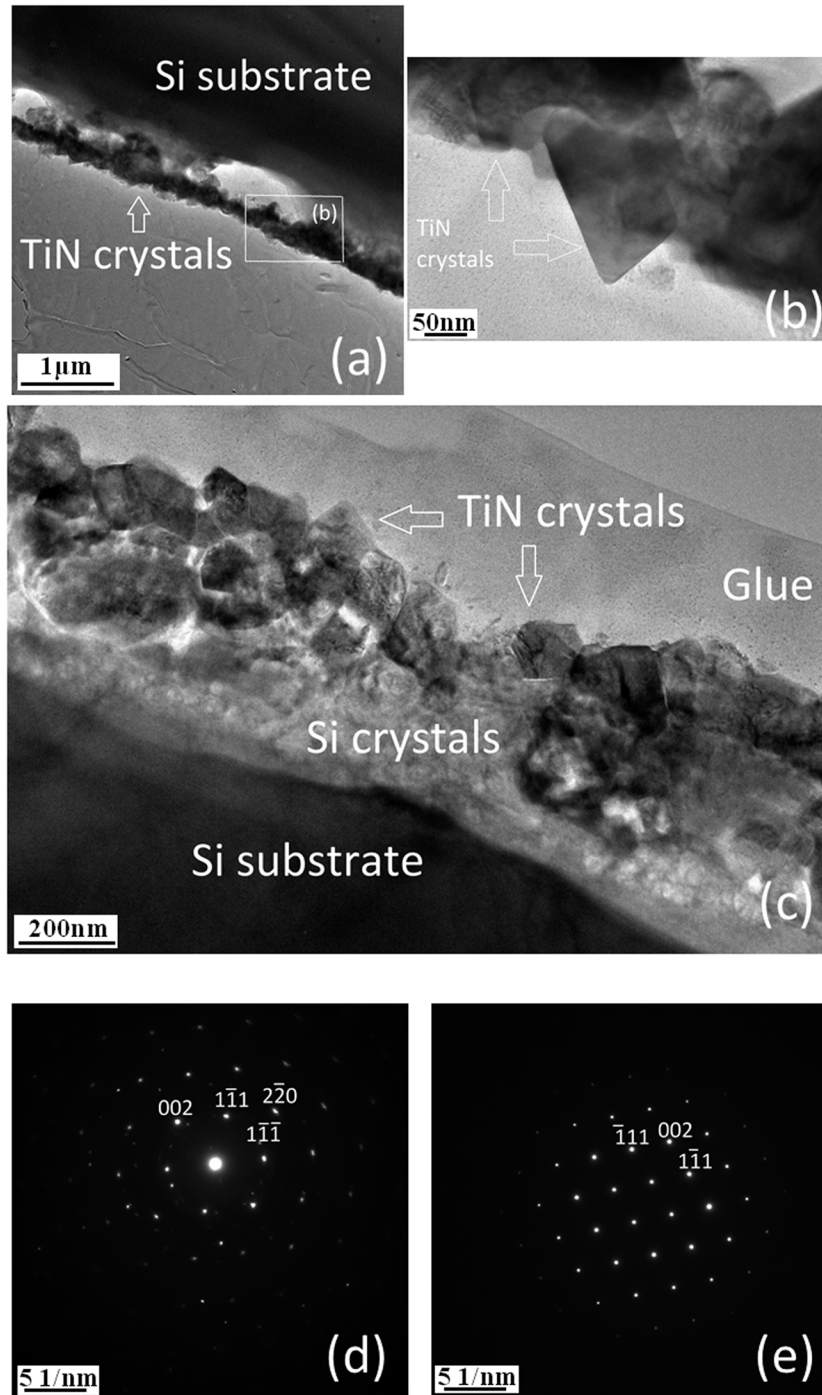

FIG. 8. Electron micrographs of Ti films heated at 800°C and exposed to $(\text{Ar}-33\%\text{N}_2-1\%\text{H}_2)$ plasma for 18 h (a) and (b). TiN crystals are viewed in the $[110]$ direction (b). Electron micrograph of another region of the film consisting of crags of TiN crossed by corridors of Si (c). SAED patterns of crags (d) and corridor (e).

3. Microstructural properties of the TiN film processed for 18 h

Ti films, 250 nm thick heated at 800°C and exposed to (Ar-33%N₂-1%H₂) for 18 h, only consist of square-shaped crystals of TiN (Fig. 8(a)).

As the final thickness of the film is determined from the growth of TiSi₂ phase, it did not change from 6 h to 18 h of treatment duration. However, the size of crystals is larger since they can reach about 200 nm wide (Fig. 8(b)). As previously seen in films processed for 6h, TiN crystals display a flattened morphology with the [110] direction perpendicular to the flat surface. The surface of the film and the film-substrate interface are very rough. No round-shaped crystals of TiSi₂ are identified. However large islands about 1 μm wide of white colour are clearly visible in the region of the film-substrate interface. Their appearance is quite similar to the amorphous Si identified in the film exposed to the plasma for 6 h. So, it seems that Si released during the formation of TiN from the reaction of TiSi₂ with nitrogen has segregated at the surface of the Si substrate. Another region of the film is shown in Fig. 8(c) which mainly consists of crags 50 to 100 nm wide extending from the surface up to the film-substrate interface and crossed by corridors which give a very rough aspect to the film. The Si substrate-film interface and the corridor consist of very small crystals of nanometric size of lighter colour embedded in a smooth and amorphous like gangue. The SAED patterns displayed in Fig. 8(d) and (e) corresponds to crags and corridor, respectively. The SAED pattern (d) shows reflections of the TiN cubic structure oriented along its [110] zone axis whereas the SAED pattern (e) is identified as Si of cubic structure oriented along its [110] zone axis similarly to the Si substrate. This result shows that Si released from the reaction between TiSi₂ and nitrogen moves towards the Si substrate by corridors where it segregates. The lack of Si reflection lines on XRD patterns after 18 h of plasma treatment is related to the fact that Si epitaxially grows on the surface of the Si substrate. Similar results have been previously obtained for TiSi₂ films, 100 nm thick and annealed in NH₃ ambient at 820°C for 1h,²⁶ although these experiments have been made under very different experimental conditions. In this work, a TiN layer varying in thickness with a maximum equal to 50 nm is identified at the surface of the film whereas the bulk of the film only consists of Si epitaxially grown on the Si substrate. So, in both experiments, Si released from the reaction between TiSi₂ and N, moves into the lower silicide region and segregates at the interface where it grows epitaxially on the Si substrate. However, in contrast with this previous work, all the TiSi₂ film about 500 nm thick is converted into TiN film with some Si localized at the film-substrate interface and through the TiN film.

IV. DISCUSSION

The simultaneous formation of silicides and nitrides at the Ti-Si interface and at the Ti film surface, respectively has been mainly studied in Ti films coated on Si substrates and processed by RTA in ambient N₂ or NH₃.^{3,8,10,11,26} Since Ti metal is very reactive towards Si, it is well established that strong Ti-Si intermixing occurs at the bottom interface with the formation of a disordered region consisting of Ti, Si and O of composition close to TiSi at very low temperatures before silicides start to grow at higher temperatures.^{27,31,24,6,22} The formation of TiSi has even been identified in Ti-amorphous Si systems at room temperature.⁴ The kinetic of formation and the structure of TiSi₂ strongly depend on previous reaction stages at least for very thin films. The growth of TiSi₂ has been found to be diffusion controlled.³ It is worth noting that in the present work, Ti films coated on Si substrates are made by titanium evaporation on Si (100) substrates heated at 400°C in the presence of impinging ions (bias equal to -400V). So the formation of amorphous Ti-Si alloys at the Ti-Si interface which improves the kinetic of formation of TiSi₂ compounds cannot be ruled out. In our previous study,²¹ we have shown that because of the high reactivity of Ti, the silicide phase is formed very rapidly. The growth of TiSi₂ and TiN phases are thermodynamically and kinetically controlled. At 400°C, Si diffuses into grain boundaries and grains of Ti and simultaneously NH_x species produced in the plasma react at the film surface and N diffuses into Ti films via grain boundaries. At 500°C, TiSi and C49TiSi₂ crystallize and simultaneously TiN of amorphous structure is formed. Ti films heated at 600°C and exposed to (Ar-33%N₂-1%H₂) plasma for 30 min consist of large crystals of TiSi₂ and TiN of amorphous structure.²¹ TiN only starts to crystallize at 800°C. The growth of the TiN phase at the expense of the TiSi₂ phase has been well evidenced in the present study. It is in

agreement with thermodynamic data since the enthalpy of formation of TiN is lower than the one of TiSi₂. The values are equal to -338 kJmol⁻¹ and -134 kJmol⁻¹, respectively.²³ To our knowledge, the simultaneous growth of TiSi₂ and TiN phases has not been so clearly evidenced up to now. In literature, authors report that both reactions are expected to proceed rapidly in opposite directions and stop when the TiSi₂ and TiN fronts meet with each other in Ti films coated on Si substrates and processed by RTA in N₂ or NH₃ ambient.^{1,3,26} Although, according to thermodynamic considerations, TiN is expected to grow at the expense of TiSi₂, the reaction of formation of TiN from TiSi₂ would be extremely slow in the range of temperatures from 400 to 600°C, and so, the nitridation of TiSi₂ would not occur at measurable rates. The nitridation of TiSi₂ only starts at 800°C.²⁶

So, in the light of the detailed results which have been obtained in this work, an attempt to describe the mechanism of formation and growth of TiN in Ti thin films heated at 800°C and exposed to (Ar-N₂-H₂) expanding plasma can be performed.

In the early stages of the process, because of the high reactivity of Ti, TiSi₂ crystals of large dimension are rapidly formed in Ti films heated at 800°C and exposed to (Ar-33%N₂-1%H₂) plasma. Simultaneously, NH_x species produced in the plasma react on the surface of the Ti film and N diffuses into the film through grain boundaries. The next stages of the process include the formation of TiN at the surface and in the bulk of the film according to the reaction between TiSi₂ and nitrogen, and the growth of the TiN phase at the expense of TiSi₂. This stage is especially emphasized by the catastrophic decrease of the intensity of the (040) reflection line of TiSi₂ and the huge increase of the (220) reflection line of TiN corresponding to films processed between 6 and 12 h. This phenomenon has been related to stresses which develop into such thin films. The formation of TiN and free Si in the bulk of the film is especially highlighted by the presence of TiN crystals of nanometric size which seem embedded in an amorphous structure consisting of Si and identified in films processed for 6 h. The growth of TiN phase leads to the formation of a layer of square-shaped crystals of TiN, 50-100 nm large on the top of round-shaped TiSi₂ crystals about 300 nm large. Growth steps have been identified on TiN (110) planes. They are formed with zigzag {111} facets. The results have also shown that (111) atomic planes of TiN crystals are adjacent to the flat and smooth TiSi₂-TiN interface. During the growth of TiN crystals, free Si moves to the Si substrate via corridors located between piles of TiN crystals where it epitaxially grows in agreement with Willemsen *et al.*²⁶ This phenomenon highlights the final stage of the process. The TiSi₂ phase is fully transformed into TiN in films processed for 18 h and TiN crystals are about 200 nm large. It is worth noting that the production of silicon nitrides in amorphous structure during the reaction between TiSi₂ and nitrogen cannot be ruled out.

V. SUMMARY AND CONCLUSIONS

Ti thin films have been processed in (Ar-33%N₂-1%H₂) expanding plasma. This process promotes the chemical reactions between the plasma species and the surface of the metal. Plasma species such as NH_x, H atoms, . . . reduce both oxide and carbide layers, which remain on the surface of the metal, as well as those which form on the surface during the process. This property allows the transfer of nitrogen into the surface of the metal to be improved. Plasma species are dissociated at the surface of the metal and diffuse into the metallic film via grain boundaries. To our knowledge, the growth of the TiN phase at the expense of TiSi₂ in Ti thin films has been clearly demonstrated in this work for the first time.

TiN is formed both at the surface and in the bulk of crystallized TiSi₂ films. It crystallizes at 800°C and grows at the expense of TiSi₂ in agreement with the respective enthalpies of formation of both compounds. The TiSi₂ crystals, 200 to 500 nm wide are gradually converted into TiN crystals, about 200 nm wide. This phenomenon has been clearly evidenced by the catastrophic decrease of the TiSi₂ (040) reflection line and the huge increase of the TiN (220) reflection line which are related to stresses which develop in thin films. The variation of morphology and microstructures of both phases during the nitriding process has been described in detail. The interface between both types of crystals is flat and smooth. In contrast, the surface of the film and the film-substrate interface are rather rough because of the large dimensions of crystals. Growth steps in the form of zigzag {111} facets have been evidenced on TiN atomic (110) planes and TiN (111) atomic planes are adjacent

to the TiSi₂-TiN interface. A mechanism of formation of TiN crystals in the bulk of the TiSi₂ phase has been described. TiN is produced during the reaction between TiSi₂ and nitrogen in TiSi₂ grain boundaries. It results in the formation of TiN crystals of nanometric size which seem embedded in an amorphous structure consisting of Si released during the reaction. Si moves towards the Si substrate through corridors between piles of TiN crystals, then it crystallizes and epitaxially grows at the film-substrate interface.

We suggest that future studies would be focused on the influence of the plasma process on the microstructure of both TiN and TiSi₂ phases, and especially on the preferred orientation of crystallites. The role of stresses, which develop in such thin films during the formation of TiSi₂ and TiN phases, will be investigated. Since the diffusion of nitrogen into titanium silicides is expected to improve the electrical properties of Schottky diodes, electrical resistivity measurements could be performed on TiSi₂-TiN films under various plasma conditions. Moreover, the influence of various transition metal interlayers on the formation and growth of silicides and nitrides would be considered.

ACKNOWLEDGMENTS

We acknowledge Thérèse Merle-Méjean for helpful discussions and L.T. Arthur for his valuable contribution. We thank the Region Limousin for the support of work on the surface reactivity.

- ¹ J.-Y. Tsai and P. Apte, *Thin Solid Films* **270**, 589–595 (1995).
- ² F. M. d'Heurle, *Journal de Physique* **IV**, 6 (1996).
- ³ S. S. Iyer, C.-Y. Ting, and P. M. Fryer, *J. Electrochem. Soc.* **132**, 2240–2245 (1985).
- ⁴ S. T. Lakshmikummar and A. C. Rastogi, *J. Vac. Sci. Technol. B* **7**, 604–608 (1989).
- ⁵ S. Jin, X. Y. Wen, and Z. Zhang, *Thin Solid Films* **249**, 50–53 (1994).
- ⁶ H. Jeon, C. A. Sukow, J. W. Honeycutt, G. A. Rozgonyi, and R. J. Nemanich, *J. Appl. Phys.* **71**, 4269–4276 (1992).
- ⁷ T. Wang, Y. B. Dai, and H.-D. Lee, *Journal of Materials Engineering and Performance* **14**, 516–518 (2005).
- ⁸ W. G. Lee and J.-G. Lee, *J. Electrochem. Soc.* **149**, G1–G7 (2002).
- ⁹ L.-L. Wang, W. Peng, Y.-L. Jiang, and B.-Z. Li, *IEEE Electron Device Letters* **36**, 597–599 (2015).
- ¹⁰ M. Bhaskaran, S. Sriram, K. T. Short, D. R. G. Mitchell, A. S. Holland, and G. K. Reeves, *J. Phys. D: Appl. Phys.* **40**, 5213–5219 (2007).
- ¹¹ A. Satka, J. Liday, R. Srnanek, A. Vincze, D. Donoval, J. Kovac, M. Vesely, and M. Michalka, *Microelectronics Journal* **37**, 1389–1395 (2006).
- ¹² J. Perez-Rigueiro, P. Herrero, C. Jimenez, R. Perez-Casero, and J. M. Martinez-Duart, *Surface and Interface Analysis* **25**, 896–903 (1997).
- ¹³ N. White, A. L. Campbell, J. T. Grant, R. Pachter, K. Eyink, R. Jakubiak, G. Martinez, and C. V. Ramana, *Appl. Surf. Sci.* **292**, 74–85 (2014).
- ¹⁴ P. K. Barhai, N. Kumari, I. Banerjee, S. K. Pabi, and S. K. Mahapatra, *Vacuum* **84**, 896–901 (2010).
- ¹⁵ N. K. Ponn, D. J. R. Appleby, E. Arac, P. J. King, S. Ganti, K. S. K. Kwa, and A. O'Neill, *Thin Solid Films* **578**, 31–37 (2015).
- ¹⁶ H. Guo, W. Chen, Y. Shan, W. Wang, Z. Zhang, and J. Jia, *Appl. Surf. Sci.* **357**, 473–478 (2015).
- ¹⁷ J. D. Wu, C. Z. Wu, X. X. Zhong, Z. M. Song, and F. M. Li, *Surf. Coat. Technol.* **96**, 330–336 (1997).
- ¹⁸ P. Patsalas, N. Kalfagiannis, and S. Kassavetis, *Materials* **8**, 3128–3154 (2015).
- ¹⁹ Y. Gong, R. Tu, and T. Goto, *Materials Transactions* **50**, 2028–2034 (2009).
- ²⁰ W. Xiang, C. Zhao, K. Liu, G. Zhang, and K. Zhao, *Journal of Alloys and Compounds* **658**, 862–866 (2016).
- ²¹ I. Jauberteau, R. Mayet, J. Cornette, D. Mangin, A. Bessaudou, P. Carles, J. L. Jauberteau, and A. Passelergue, *Coatings* **7**, 14 (2017).
- ²² O. Chaix-Pluchery, B. Chenevier, I. Matko, J. P. Senateur, and F. La Via, *J. Appl. Phys.* **96**, 361–368 (2004).
- ²³ Y. C. Ee, Z. Chen, L. Chan, K. H. See, S. B. Law, S. Xu, Z. L. Tsakadze, P. P. Rutkevych, K. Y. Zeng, and L. Shen, *J. Vac. Sci. Technol. B* **23**, 2444–2448 (2005).
- ²⁴ R. Butz, G. W. Rubloff, T. Y. Tan, and P. S. Ho, *Phys. Rev. B* **30**, 5421–5429 (1984).
- ²⁵ I. Jauberteau, R. Mayet, J. Cornette, A. Bessaudou, P. Carles, J. L. Jauberteau, and T. M. Méjean, *Surf. Coat. Technol.* **270**, 77–85 (2015).
- ²⁶ M. F. C. Willemsen, A. E. T. Kuiper, A. H. Reader, R. Hokke, and J. C. Barbour, *J. Vac. Sci. Technol. B* **6**, 53–61 (1987).
- ²⁷ R. J. Nemanich, R. W. Fiordalice, and H. Jeon, *IEEE Journal of Quantum Electronics* **25**, 997–1002 (1989).
- ²⁸ S.-L. Zhang, C. Lavoie, C. Cabral, Jr., J. M. E. Harper, F. M. d'Heurle, and J. Jordan-Sweet, *J. Appl. Phys.* **85**, 2617–2626 (1999).
- ²⁹ W. Xiang, C. Zhao, K. Liu, G. Zhang, and K. Zhao, *J. Alloys Compd.* **658**, 862–866 (2016).
- ³⁰ L. I. Zongquan, S. Hui, and Q. Yong, *Chinese Physics Letters* **7**, 245–247 (1990).
- ³¹ R. J. Nemanich, R. T. Fulks, B. L. Stafford, and H. A. Vander Plas, *J. Vac. Sci. Technol. A* **3**, 938–941 (1984).