



HAL
open science

An architecture for controlling the remaining useful lifetime of a friction drive system

Diego Jair Rodriguez Obando, John Jairo Martinez Molina, Christophe Bérenguer

► **To cite this version:**

Diego Jair Rodriguez Obando, John Jairo Martinez Molina, Christophe Bérenguer. An architecture for controlling the remaining useful lifetime of a friction drive system. SAFEPROCESS 2018 - 10th IFAC Symposium on Fault Detection, Supervision and Safety for Technical Processes, IFAC, Aug 2018, Varsovie, Poland. pp.861-866, 10.1016/j.ifacol.2018.09.676 . hal-01870552

HAL Id: hal-01870552

<https://hal.science/hal-01870552v1>

Submitted on 7 Sep 2018

HAL is a multi-disciplinary open access archive for the deposit and dissemination of scientific research documents, whether they are published or not. The documents may come from teaching and research institutions in France or abroad, or from public or private research centers.

L'archive ouverte pluridisciplinaire **HAL**, est destinée au dépôt et à la diffusion de documents scientifiques de niveau recherche, publiés ou non, émanant des établissements d'enseignement et de recherche français ou étrangers, des laboratoires publics ou privés.

An architecture for controlling the remaining useful lifetime of a friction drive system

Diego J. Rodriguez* John J. Martinez*
Christophe Berenguer*

* *Univ. Grenoble Alpes, CNRS, Grenoble-INP, GIPSA-lab, 38000
Grenoble, France (e-mail: diego.rodriguez-obando, john.martinez,
christophe.berenguer@gipsa-lab.fr).*

Abstract: This paper presents an approach to control the remaining useful lifetime (RUL) of a friction drive system. The approach is based on the assumption that the system deterioration is a consequence of the motion control actions. These control actions have short-term objectives that have to be modified, based on the predicted RUL, to be compatible with the required/desired RUL. Here, a RUL actuating principle is proposed in order to control the RUL. That actuating principle is based on a parametric varying filter which modifies the motion control realization based on the available information about the expected RUL. The total RUL control architecture also includes an operating condition estimator, a system state estimator, and a RUL predictor. The RUL controller determines the parameters of the actuating filter by solving an on-line optimization problem. The RUL controller has to solve the RUL control problem by considering a trade-off between the desired motion control actions and the desired RUL. A numerical example illustrates the behavior of the proposed control architecture.

Keywords: Remaining useful lifetime, prognostics, RUL control, parameter-varying systems.

1. INTRODUCTION

Several motion applications are based on friction. Friction rollers, railway wheels, and friction drive electrical bicycles are examples of this kind of actuators. The power delivered by the motor is transformed into mechanical power on the driven side through the contact forces. In practice, the contact surfaces of the motor device and the driven device deteriorate and their deterioration reaches eventually a threshold above which the system is considered as a failed system. The “deterioration” can be considered as a loss of the ability of the actuator to transfer power to the driven device.

The Remaining Useful Lifetime (RUL) is defined as the time left before a component or system no longer perform its intended function. This time mostly depends on the state of deterioration of the components and the operating conditions. Accurately predicting the RUL is still an open problem (Si et al., 2011). This prediction is generally affected by exogenous and endogenous uncertainties. Even if a given mechanical system model is well-known, there are several sources of uncertainties that affect the precision of the RUL prediction. For instance, the initial condition of the deterioration and its dynamical behavior, the future operation conditions, the measurement noise and process disturbances are generally considered into the literature.

The motion control actions are seen as a source of stress deteriorating the actuator, see for instance (Langeron et al., 2017), (Rakowsky, 2006) and (Meyer and Sextro, 2014). In (Grosso et al., 2012) and (Pereira et al., 2010),

the authors assume a deterministic relationship between the degradation and the motion control input. Therefore, controlling the RUL of a component could be achieved by modifying, in a suitable way, the motion control laws.

This paper presents an approach to control the remaining useful lifetime (RUL) of a friction drive system. The approach is based on the assumption that the system deterioration is a consequence of the motion control actions. These control actions have short-term objectives that have to be modified to be compatible with the required/desired RUL. Here, a RUL actuating principle is proposed in order to control the RUL. The proposed RUL actuating principle is based on a parametric varying filter which modifies the motion control realization based on the available information about the expected RUL. The total RUL control architecture also includes an operating condition estimator, a system state estimator, and a RUL predictor. The RUL controller determines the parameters of the actuating filter by solving an on-line optimization problem. The RUL controller has to solve the RUL control problem by considering a trade-off between desired motion control actions and desired RUL.

2. SYSTEM DESCRIPTION

Consider the following dynamical friction drive system model, as presented in (Rodriguez Obando et al., 2016):

$$J_1 \dot{\omega}_1 = T_m - F_c r_1 - b_1 \omega_1 \quad (1)$$

$$J_2 \dot{\omega}_2 = F_c r_2 - b_2 \omega_2 - T_{load} \quad (2)$$

$$F_c = \alpha(r_1 \omega_1 - r_2 \omega_2) \quad (3)$$

where ω_1 and ω_2 are the angular speeds of the motor and driven device, respectively. T_m is the motor torque and T_{load} the driven load. The symbols J_1 , J_2 , r_1 , r_2 , b_1 and b_2 are known constant mechanical parameters of the system. F_c stands for the contact forces allowing the transmission of mechanical power from the motor to the driven device. That force is approximated by a linear function of the relative tangential speed $(r_1\omega_1 - r_2\omega_2)$ and an uncertain parameter α , called here the contact quality coefficient.

As proposed in (Rodriguez Obando et al., 2016), the deterioration rate of the contact quality coefficient can be modeled as a function of the dissipated energy at the contact surface level, i.e.

$$\dot{D} = \alpha(r_1\omega_1 - r_2\omega_2)^2 \quad (4)$$

where D represents a value of deterioration. This dissipated energy can be considered as an image of the heat and the material worn at the contact surface level during traction. In addition, we assume, that the contact quality coefficient α changes according to the following dynamics:

$$\dot{\alpha} = -m\alpha(r_1\omega_1 - r_2\omega_2)^2 \quad (5)$$

which means that, for $m > 0$, the deterioration D increases when α decreases. There is uncertainty on m , and this parameter can also vary with time. From (5), remark that the contact quality coefficient decreases if values of $(r_1\omega_1 - r_2\omega_2)^2$ increase. The rate of the decreasing of α also depends on the current state of α and the uncertain parameter m . Remark also that the trajectory of the states for system (1)-(3), i.e. ω_1 , ω_2 , D and/or α can be modified by using the input T_m .

3. PROBLEM STATEMENT

In this paper, it is assumed that a system state estimator (e.g. a state observer) is available. See for instance (Rodriguez Obando et al., 2017) where an Extended Kalman Filter has been proposed for simultaneously estimating the current values of α and m by assuming that ω_1 and ω_2 are measured. In addition, it is assumed that the current operation conditions are known and assumed to remain unchanged on the predicting horizon to predict the RUL. The latter can be achieved by a RUL predictor, as it is proposed in (Rodriguez Obando et al., 2017). The following definitions are necessary for establishing the RUL control problem:

Definition 1. At a given time t , the desired RUL, denoted RUL^{ref} , is the desired remaining period of time before the friction drive system can no longer perform its intended function (i.e. transmitting mechanical power from the motor to the driven device).

Definition 2. At a given time t , the predicted RUL, denoted \hat{RUL} , is the predicted remaining period of time before the friction drive system can no longer perform its intended function. The predicted RUL is a random variable, which can be characterized by e.g. a probability distribution or a confidence metrics.

Now, the problem of controlling the RUL can be formulated as follows:

Problem 1. Given a mechanical friction drive system (1)-(5), find, at every time-instant, the motor torque T_m (the

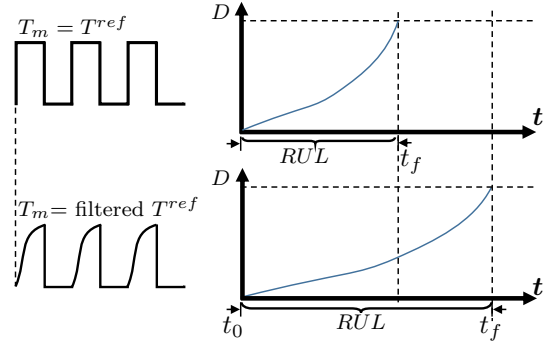

Fig. 1. Illustration of the obtained RUL for two different sequences of the motor torque. The obtained RUL increases in cases where the motor torque is a filtered (or smoothed) signal of T^{ref} .

only manipulable input of the system), which guarantees that the predicted RUL follows the desired one.

Due to the fact that the mechanical friction drive system has to follow possible short-time motion demands, the Problem 1 has to be reformulated in order to include these motion requirements. In the sequel we use the following additional definitions:

Definition 3. The desired torque, denoted T^{ref} , is an exogenous motion demand which could be provided by a motion control system or a reference generator.

Definition 4. The demanded motion satisfaction, denoted S^{ref} , is a value between 0 and 1 which quantifies the ability to deliver a motor torque T_m from a given reference torque T^{ref} . Thus, $S^{ref} = 1$ means that it is desired to obtain $T_m = T^{ref}$. A value of S^{ref} close to zero means that the applied torque T_m could be very different to T^{ref} .

Figure 1 depicts two possible scenarios of deterioration. The first case concerns the case where $T_m = T^{ref}$ and the second case when T_m is a filtered signal of T^{ref} . This example clearly shows that filtering the input command to the motor (and removing the sharp edges in the command) decreases the deterioration rate, and increases the system lifetime. This phenomenon will be used to control the system RUL by modifying appropriately the motor command input.

Hence, by assuming the existence of a parameter varying filter, denoted $H(\theta)$, with θ a vector containing the filter parameters, which generates T_m from T^{ref} , the problem now becomes as follows:

Problem 2. Given a friction drive system (1)-(5), find, at every time-instant, the parameters of the filter $H(\theta)$, such that the obtained motor torque T_m guarantees that the predicted RUL follows the desired one and respects as much as possible the demanded torque T^{ref} .

This problem can be solved as an on-line optimization problem that have to consider a trade-off between desired demanded motion satisfaction and desired RUL. The RUL control architecture will be presented in the next Section.

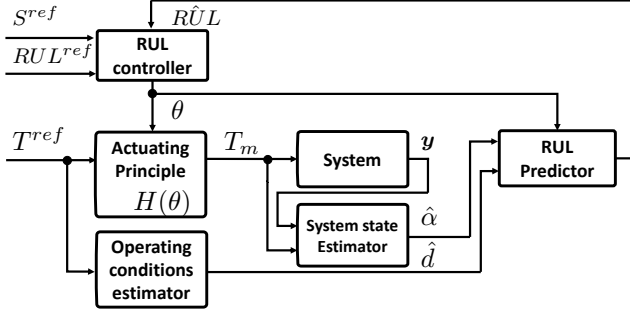

Fig. 2. Architecture for an optimal control of the RUL.

4. PROPOSED RUL CONTROL ARCHITECTURE

The proposed RUL control architecture of a friction drive system, is depicted in Figure 2. The main novelty of the proposed RUL control architecture concerns a parametric varying filter (called here the actuating principle). This parametric varying filter is intended to modify the motion control realization in order to actuate on the values of the predicted RUL. The RUL control architecture also includes an operating condition estimator, a system state estimator, and a RUL predictor. The RUL controller determines the scheduling parameters of the actuating filter by solving an on-line optimization problem. Every component of the control architecture is described in more details in the next subsections.

4.1 The RUL actuating principle

Considering the fact that the deterioration of the system is influenced by the shape of the signal T_m (the motor torque), the desired torque T^{ref} can be filtered by a filter $H(\theta)$ in order to modify, in real-time, the shape of the applied motor torque, i.e.

$$T_m = H(\theta) T^{ref} \quad (6)$$

where θ represents a time-varying parameter vector generated by the RUL controller. Since the signal T^{ref} has to verify short-time motion requirements, the choice of the filter $H(\theta)$ allow us to constraint the original signal T^{ref} for generating a constrained signal T_m for satisfying long-term requirements. This solution is adopted here, since it can be seen as a particular realization of a Model Predictive Controller. The proposed architecture admits other versions of Model Predictive Controllers for constraining the motor torque and include other possible short-time state and/or control constraints. Here, two aspects are considered for constraining the signal T_m , the amplitude of the signal and its time-derivatives. Both these aspects are considered as sources of deterioration. High amplitudes and high time-derivatives of T_m produce more deterioration and then decrease the predicted RUL.

Figure 3 sketches out possible applied motor torques with respect to the desired one $T^{ref}(t)$.

4.2 The RUL predictor

Figure 2 shows the place of the RUL predictor into the control architecture. Here, it is supposed that the RUL predictor uses a dynamical model of the mechanical system together with a dynamical model of the deterioration (or

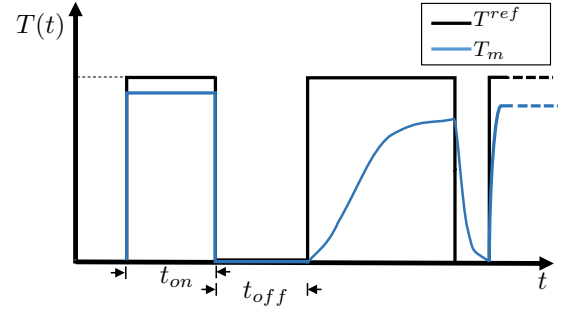

Fig. 3. Examples of applied motor torque T_m compared with respect to the desired one T^{ref} .

an image of the deterioration). Since the quality of contact coefficient α is an image of the deterioration, its value and its associated uncertainty are estimated by a state estimator and used into the RUL predictor. In addition, the RUL predictor uses the information about the current operation conditions and performs the prediction based on the assumption that such operations conditions remain unchanged along the future time. In this paper, it is assumed that the operations conditions are easily obtained from the desired torques T^{ref} , and by consequence the value of the vector θ (the output of the RUL controller) will also be part of the necessary information for performing the prediction. Other solutions could just use the applied torque (the signal T_m) and any available image of the deterioration for performing the RUL prediction.

Figure 2 illustrates the case where the signal θ , $\hat{\alpha}$ and \hat{d} are used. The latter corresponds to a metrics which characterizes the desired torques. The signal \hat{d} could also include any other information about the past, current or future operation conditions. By consequence, the RUL prediction will be a function of these inputs. That is, at every time instant, it follows that

$$R\hat{U}L := R\hat{U}L(\hat{\alpha}, \hat{d}, \theta) \quad (7)$$

Figure 5 illustrates an example of the behavior of the predicted RUL for different values of $\hat{\alpha}$, \hat{d} and θ . Remark that the vector θ is the only tunable variable which allows the modification of the predicted RUL. This aspect is exploited by the RUL controller which decides, in real-time, the values of the vector θ to assure the “tracking” of a desired RUL. This is explained in the following subsection.

4.3 The RUL controller

The RUL controller is intended to solve the control problem stated in Section 3. This controller has to continuously decide the values of the vector θ (the parameters of the filter $H(\theta)$ in (6)), as a function of the predicted RUL and minimizing a given cost function J , for instance:

$$J := J\left(RUL^{ref}, R\hat{U}L(\theta), S^{ref}, S(\theta)\right) \quad (8)$$

where RUL^{ref} represents the desired RUL and S^{ref} the demanded motion satisfaction. The symbols $R\hat{U}L(\theta)$ and $S(\theta)$ represent the predicted RUL as a function of θ and the obtained motion satisfaction, respectively. In this paper, it is assumed that the cost function (8) includes also scalar values which allows considering a trade-off between

the obtained predicted RUL and the obtained motion satisfaction $S(\theta)$.

Figure 2 shows the place of the RUL controller into the proposed control architecture. The RUL controller can provide a decision variable θ by solving, at every time-instant, the following optimization problem:

$$\begin{aligned} & \underset{\theta}{\text{minimize}} && J\left(RUL^{ref}, \hat{RUL}(\theta), S^{ref}, S(\theta)\right) \\ & \text{subject to} && f_i(x, u) \leq 0, \quad i = 1, \dots, m. \end{aligned} \quad (9)$$

where the functions $f_i(x, u)$ allow the inclusion of other constraints on the system states x and/or on the system controls u . Remark that the optimization problem could be solved in real-time or by using an *a priori* calculated look-up table.

5. NUMERICAL EXAMPLE

In this section the behavior of the proposed control architecture is illustrated by using the friction drive system (1)-(5) with values presented in Table 1.

5.1 Chosen scenario

For simplicity, the following scenario has been chosen:

- The desired torque T^{ref} is a rectangular waveform with duty-cycle equal to 50%.
- The signal T^{ref} is active during a period of time t_{on} , as it depicted in Figure 3.
- The period of time t_{on} is assumed to be known but it can change along the time, modifying the predicted RUL.
- The operation conditions estimator provides the exact value of t_{on} in seconds. That is, $\hat{d} = t_{on}$. This values is assumed to be bounded as follows: $0 < t_{on} \leq 50$.
- A state estimator provides the values of the estimated contact quality coefficient, i.e. $\hat{\alpha}$ by using available measurements and/or signals. Here, the state estimator uses the applied motor torque T_m and the measurements y (rotational speeds of the motor and driven device).

5.2 Chosen parametric varying filter

In this example it is used a first order filter:

$$H(\theta, s) = \frac{\theta_1}{1 + \theta_2 s} \quad (10)$$

where s depicts the complex variable in Laplace representation, and θ is a parameter vector $\theta = [\theta_1 \ \theta_2]^T$. Remark that the parameter θ_1 modifies the gain of the transfer function (10), in the meantime θ_2 mostly modifies the time-response of the applied torque with respect to the desired one.

Taking (6) and (10) it can be obtained the following dynamical equation which describes the time-derivatives of the applied motor torque T_m :

$$\dot{T}_m(t) = -\frac{1}{\theta_2} T_m(t) + \frac{\theta_1}{\theta_2} T^{ref}(t) \quad (11)$$

It is assumed that the amplitude of the signal $T_m(t)$ and its time-derivative with respect to the time are bounded.

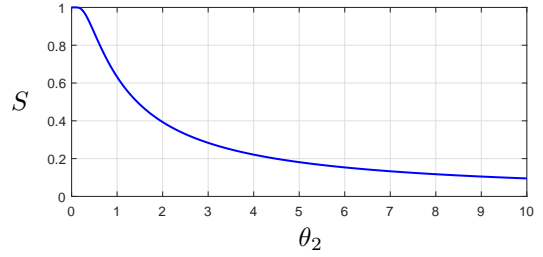

Fig. 4. Obtained motion satisfaction S as a function of the parameter θ_2 .

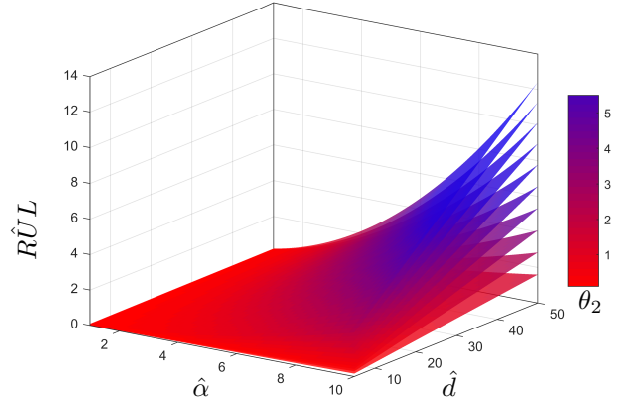

Fig. 5. Predicted RUL as function of the parameter θ_2 , the estimated contact quality coefficient $\hat{\alpha}$ and the operation conditions \hat{d} .

Table 1. Nomenclature and used values

Symb.	Value	Units	Physical meaning
ω_1		[rad/s]	Angular speed of the motor
ω_2		[rad/s]	Angular speed of the driven device
r_1	0.0315	[m]	External radius of the motor
r_2	0.35	[m]	External radius of the driven device
b_1	6.36×10^{-3}	[Kg m ² /s]	Viscous friction coefficient
b_2	1.76×10^{-3}	[Kg m ² /s]	Viscous friction coefficient
J_1	3.47×10^{-4}	[Kg m ²]	Moment of inertia of the motor
J_2	0.2	[Kg m ²]	Moment of inertia of the driven device
$\alpha(0)$	10	[N s/m]	Contact quality coefficient
m	0.01	-	Parameter of the dynamics of α

In this example the RUL controller will modify the values of θ_2 and it will maintain $\theta_1 = 1$, for simplicity.

According to the definition 4, the demanded motion satisfaction S^{ref} quantifies how much the form of the curve T_m is near to the demanded T^{ref} . In this example, it will be a value between 0 and 1. Here the obtained motion satisfaction will be quantified by using the following function:

$$S(\theta) = 1 - e^{-1/\theta_2} \quad (12)$$

which decreases as long as the parameter θ_2 increases as it is illustrated in Figure 4. On the other hand, Figure 5 depicts the predicted RUL for different values of the parameter θ_2 , as a function of the current values of the estimated contact quality coefficient $\hat{\alpha}$ and the operation conditions \hat{d} . The used RUL predictor will be described in the next subsection.

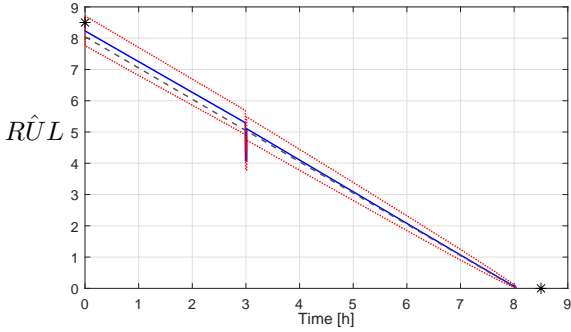

Fig. 6. Predicted RUL along the time: 1) by using the mean value of the estimated α (solid line), 2) by using extreme values of the estimated α (dotted line). Both compared with respect to the obtained RUL (dashed line). The symbol * represents the desired RUL.

5.3 Used RUL predictor

In this example, a model-based RUL predictor as that proposed in (Rodriguez Obando et al., 2017) has been used. The friction drive system (1)-(5) together with the filter dynamics (11) can be rewritten in state space form as the following extended dynamical system:

$$\dot{\mathbf{x}} = \mathbf{F}(\mathbf{x}) + \mathbf{B}\mathbf{w} \quad (13)$$

with an extended state defined as $\mathbf{x} := [\omega_1 \ \omega_2 \ \alpha \ T_m]^T$, the exogenous input $\mathbf{w} := T^{ref}$, and the matrix $\mathbf{B} := [0 \ 0 \ 0 \ 1/\theta_2]^T$. The symbol $\mathbf{F}(\mathbf{x})$ represents the non-linear functions of the extended state dynamics.

At every time-instant $t = t_0$, the RUL prediction can be performed by simulating the system (13) with initial conditions (i.e. at time equal to t_0) belonging to a set of values. Some of these values are measured (e.g. ω_1 , ω_2 , and T_m). However the state α , related to the deterioration, is estimated and the true value belongs to a given interval or set (i.e. it could be a stochastic set provided by the state estimator). Here, the confidence intervals provided by an Extended Kalman Filter, as proposed in (Rodriguez Obando et al., 2017), have been used.

The prediction can be stopped once the maximal deterioration has been achieved, that is for $\alpha(t_f) = 0$ (equivalently $D(t_f) = \sup\{D\}$). Thus, the predicted RUL is computed as $\hat{RUL} = t_f - t_0$. Figure 6 depicts the obtained \hat{RUL} with respect to the time. This figure also illustrates the changes on the predicted RUL in cases where the operation conditions changes. Here a changes on the variable \hat{d} appears at $t = 3h$.

5.4 Implemented RUL controller

We propose to use an optimal controller to solve the Problem 2, which minimizes a cost function including a double objective (i.e. satisfy both a desired RUL and a desired torque). The problem can be reformulated as a single-objective optimization problem by using a suitable scalarization. That is,

Problem 3. Given $\hat{\alpha}$ and \hat{d} at a time t_0 , find the value of θ_2 which minimizes the cost function:

$$J(\theta_2) = \left(\frac{RUL^{ref} - \hat{RUL}(\theta_2)}{RUL^{ref}} \right) + \rho (S^{ref} - S(\theta_2)) \quad (14)$$

subject to:

$$0 \leq \theta_2 \leq \bar{\theta}_2 \quad (15)$$

where $\rho > 0$ is a real value which allows considering a trade-off between satisfying desired RUL and/or satisfying the desired torque. In this example it was chosen $\bar{\theta}_2 = 6$ and $\rho = 0.5$. The chosen weighting scalar ρ suggests that we put more focus on the respect of the desired RUL rather than on the respect of the desired torque. Here we assume also that the desired RUL^{ref} will be bigger than the estimated RUL to maintain the positivity of this cost function.

Figure 7 illustrates the behavior of the proposed controller. In this scenario we use $RUL^{ref} = 8.5h$, $S^{ref} = 1$ and introduce a change at $t = 3h$ on the operating conditions characterizing T^{ref} . Namely, T^{ref} is characterized by $d = 40s$, and after $t = 3h$ the operating conditions change by $d = 30s$. Remark that the RUL controller decides to modify the value of the filter parameter θ_2 . This value increases in order to reduce the rate of the deterioration due to the changes on the operations conditions \hat{d} . The RUL predictor updates the value of the operation conditions and it gets closer to the true description of the RUL (dashed line in Figure 7). Remark that at time $t = 3h$ there is a considerable transient. This is due to the fact that the RUL predictor uses the new value of the operation conditions \hat{d} but the RUL controller has not yet updated the new value of θ , as depicted in Figure 8.

For comparison, Figure 9 shows the obtained trajectories of $\hat{\alpha}$ for three cases: case 1, the RUL of the system is non-controlled (solid line), it is observed an important decreasing of the contact quality coefficient α (which implies a very fast deterioration), reaching the failure at $1.18h$. Case 2, the RUL controller provides the optimal parameter θ_2 at the beginning of the lifetime and used it during the whole lifetime assuming no changes in the operation conditions \hat{d} . In this case the system reaches a failure time at $7.08h$ which is still far of the desired RUL. Case 3, the RUL predictor uses the current value d and $\hat{\alpha}$ to update the RUL prediction and then the RUL controller finds a new optimal parameter θ_2 in order to adapt the behavior of the system. In this case the system reaches a failure time of $8.06h$ which is closer to the desired RUL which have been chosen as $RUL^{ref} = 8.5h$.

6. CONCLUSIONS AND FUTURE WORK

In this paper, a novel Remaining Useful Lifetime (RUL) control architecture is presented. The control law is based on the on-line available prediction of the RUL (which includes a dynamical model of the mechanical system and its deterioration). The RUL controller can be implemented as an optimal controller which decides, in real-time, the parameters of a filter (called here the RUL actuating principle) in order to modify the predicted RUL. The parameter varying filter is intended for smoothing the desired torque (associated to a desired motion requirement) in order to increase or decrease the predicted RUL. An example of an optimal controller which deals with two opposite criteria, respect of the desired torque and respect of the desired RUL, has been presented. In this work we have illustrated the role and the importance of the

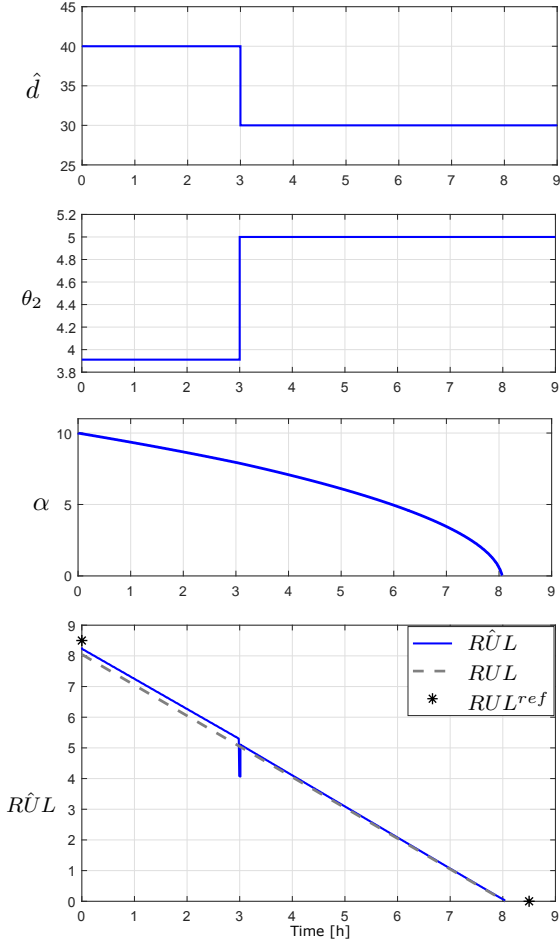

Fig. 7. System behavior under the effect of the RUL controller.

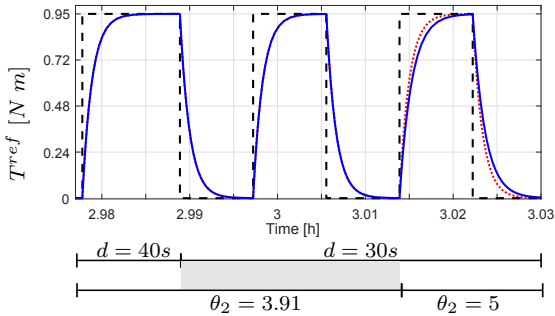

Fig. 8. The desired torque T^{ref} (dashed line) and the applied motor torque T_m (solid line). For comparison, the dotted line corresponds to the applied torque without updating the value of the parameter θ_2 .

RUL prediction for generating suitable control actions. As a future work, the proposed control architecture will be revisited into a stochastic context by considering more endogenous and exogenous sources of uncertainties into the RUL prediction and into the RUL control.

ACKNOWLEDGEMENTS

This work was partially supported by the French CNRS PEPS 2017 in the context of the IMPROVED project.

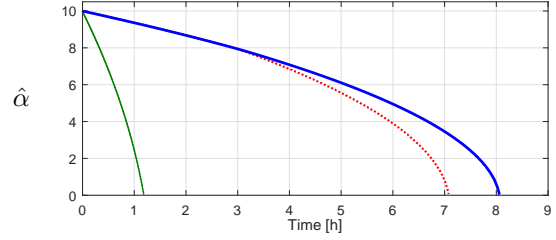

Fig. 9. Estimated contact quality coefficient $\hat{\alpha}$ in presence of operation conditions changes and for three different cases: 1) without RUL control, 2) with a RUL control without updating the RUL prediction, and 3) with a RUL control which adapts the control actions according to the current RUL prediction.

REFERENCES

- Grosso, J.M., Ocampo-Martínez, C., and Puig, V. (2012). A service reliability model predictive control with dynamic safety stocks and actuators health monitoring for drinking water networks. In *Decision and Control (CDC), 2012 IEEE 51st Annual Conference on*, 4568–4573. IEEE.
- Langeron, Y., Grall, A., and Barros, A. (2017). Joint maintenance and controller reconfiguration policy for a gradually deteriorating control system. *Proceedings of the Institution of Mechanical Engineers, Part O: Journal of Risk and Reliability*, 231(4), 339–349.
- Meyer, T. and Sextro, W. (2014). Closed-loop control system for the reliability of intelligent mechatronic systems. In *European Conference of the Prognostics and Health Management Society - 2014 - Paderborn, Germany*, 53–57.
- Pereira, E.B., Galvão, R.K.H., and Yoneyama, T. (2010). Model predictive control using prognosis and health monitoring of actuators. In *Industrial Electronics (ISIE), 2010 IEEE International Symposium on*, 237–243. IEEE.
- Rakowsky, U.K. (2006). Modelling reliability-adaptive multi-system operation. *International Journal of Automation and Computing*, 3(2), 192–198.
- Rodríguez Obando, D.J., Martínez Molina, J.J., and Berenguer, C. (2016). Set-invariance analysis for deterioration prediction on a roller-on-tire actuator. In *Proc. 3rd Conference on Control and Fault-Tolerant Systems - SysTol2016 - 7-9 Sep. 2016 - Barcelona, Spain*, 87–92.
- Rodríguez Obando, D.J., Martínez Molina, J.J., and Berenguer, C. (2017). Deterioration estimation for remaining useful lifetime prognosis in a friction drive system. In *Proc. 20th World Congress of the International Federation of Automatic Control - IFAC 2017, Jul. 2017. Toulouse, France*, 13324–13329.
- Si, X.S., Wang, W., Hu, C.H., and Zhou, D.H. (2011). Remaining useful life estimation—a review on the statistical data driven approaches. *European Journal of Operational Research*, 213(1), 1–14.