



HAL
open science

Optimisation and realisation of a portable NMR apparatus and Micro Antenna for NMR

Patrick Poulichet, Latifa Fakri-Bouchet, Christophe Delabie, Lionel Rousseau,
Abdenasser Fakri, Anne Exertier

► **To cite this version:**

Patrick Poulichet, Latifa Fakri-Bouchet, Christophe Delabie, Lionel Rousseau, Abdenasser Fakri, et al.. Optimisation and realisation of a portable NMR apparatus and Micro Antenna for NMR. Design, Test, Integration & Packaging of MEMS/MOEMS (DTIP 2011), May 2011, Aix-en-Provence, France. hal-01870545

HAL Id: hal-01870545

<https://hal.science/hal-01870545>

Submitted on 7 Jan 2020

HAL is a multi-disciplinary open access archive for the deposit and dissemination of scientific research documents, whether they are published or not. The documents may come from teaching and research institutions in France or abroad, or from public or private research centers.

L'archive ouverte pluridisciplinaire **HAL**, est destinée au dépôt et à la diffusion de documents scientifiques de niveau recherche, publiés ou non, émanant des établissements d'enseignement et de recherche français ou étrangers, des laboratoires publics ou privés.



11-13 May 2011, Aix-en-Provence, France

Optimisation and realisation of a portable NMR apparatus and Micro Antenna for NMR

Patrick Poulichet¹, Latifa Fakri-Bouchet², Christophe Delabie¹, Lionel Rousseau¹, Abdenasser Fakri¹ and Anne Exertier¹

ESIEE, 2 BD Blaise Pascal, 93162 Noisy Le Grand, France¹

Laboratoire CREATIS - LRMN UMR CNRS 5220, INSERM U630, INSA de Lyon 3, rue Victor-Grignard, 69616 Villeurbanne, France²

p.poulichet@esiee.fr (+33) 1.45.92.67.18

Latifa.Fakri-Bouchet@creatis.univ-lyon1.fr (+33) 4.72.44.82.08

Abstract- This paper is focused on two designs and realizations. The first one concerns a prototype of a portable NMR (nuclear magnetic resonance) apparatus. The second one concerns NMR micro antenna realization.

For the first part, our goal is the NMR magnetic field homogeneity and the signal-to-noise ratio (SNR) improvement. Since de the volume of the sample to analyse is around 1 cm³, the design is optimized to obtain a good SNR. Particularly, the magnet is chosen to obtain a high magnetic field with limited inhomogeneities. The receiver antenna is designed and optimized to have high feeling factor and then more sensitivity. A mixer and a low-pass filter are used in order to limit the bandwidth and reduce the thermal noise. The FID is digitized and addressed to a FPGA which averages successive acquisitions in order to increase the SNR. The final acquisition is processed for determining the FID spectrum.

In the second part, a new concept of micro coil is presented in order to measure the small volumes and small concentrations samples by NMR spectroscopy at 4.7 T (200 MHz proton frequency resonance).

This micro sensor would offer the possibility of new investigation techniques based on micro coils' implantation used for in vivo study of local cerebral metabolites of animals models.

Keyword: NMR, single side, portable, magnet, micro coil.

I. INTRODUCTION

The NMR signal measurement requires a static magnetic field B₀ and a pulsed frequency varying B₁ magnetic field. The studied sample is submitted to these magnetic fields. Then, the B₁ magnetic field is applied at a Larmor frequency (1T correspond to 42.57 MHz), is applied, the signal FID (Free Induction Decay) generated by magnetization motion is acquired using a detection coil.

In mobile NMR, B₀ is generated with an arrangement of magnets in order to deliver a homogeneous magnetic field. For measurement of the relaxation (T₂ or T₁) or a spectrum, inhomogeneities must be as low as possible particularly if the objective of the measurement is spectroscopy ($\Delta B_0/B_0 \cong 10$ ppm).

Reference [4] is a review of the different ways of the array magnets setup in order to obtain the best B₀ homogeneity. Reference [1] reports the construction of a mobile tomography device by exploiting the concept of movable permanent magnets in the shim unit of a Halbach array. The cross section of a banana placed inside the magnets is presented. Reference [2] proposes a complete procedure for permanent magnet design, fabrication, characterization and shimming. 1H NMR spectrum of a 3 mm³ sample of water doped with CuSO₄ in the shimmed magnet is presented. The half-height full width (HHFW) is about 12 ppm. Reference [3] presents a single-sided mobile NMR apparatus with a small Halbach magnet. It is lightweight, compact and exhibits good sensitivity.

Reference [5] the spectrometer design that uses an FPGA. The system is composed of an FPGA chip and several peripheral boards for USB communication, direct-digital synthesis (DDS), RF transmission, signal acquisition, etc. In the FPGA have been implemented a number of digital modules including three pulse programmers, the digital part of DDS, a digital quadrature demodulator, dual digital low-pass filters, and a PC interface have been implemented.

The feasibility to use a new generation of microcoils was proposed in a recent study [6]. It demonstrated potential opportunities in terms of increased signal-to-noise ratio (SNR), spatial resolution, and limits of detection (LOD) [7] compared to the surface-coil [8]. Their use for localized spectroscopic studies of NMR observable cerebral metabolites into 2mm³ region of interest (ROI), aims to push limits of in vivo detection.

II. MOBILE NMR

In our design, we used the mains parts describe in [5] in order to realize portable NMR apparatus dedicated to portable NMR. The aim is to optimize the SNR. The magnet (alnico) uses two large piece of steel in order to reduce inhomogeneities of the magnetic field.

Fig. 1 shows the functional schematic of the spectrometer connected to the PA (Power Amplifier) and connected to

the LNA (Low Noise Amplifier). The duplexer use a circuit with two diodes for ensuring a good isolation when a signal is applied to the generation coil.

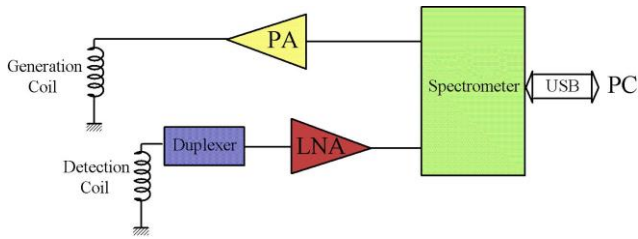

Fig. 1. Functional schematic of the connexions between the spectrometer and the coils

A. Optimisation of the SNR

Like the volume of the sample to analyze is around $4,6 \text{ cm}^3$, we choose the dimension of the air gap, the wire diameter, the noise factor of the preamplifier in order to deliver a signal above the noise. The measured induction B_0 is $0,116 \text{ T}$. With the constant gyromagnetique γ , we determine the Larmor frequency :

$$f_0 = \frac{1}{2\pi} \gamma \cdot B_0 = 4.92 \text{ MHz}$$

With the value of the Plank constant h and the Bolzman constant k , we obtain the magnetic moment M_0 :

$$M_0 = N \cdot \gamma^2 \cdot 3 \cdot \hbar^2 \frac{B_0}{4 \cdot k \cdot T} = 9,9 \cdot 10^{-6}$$

The FID value is : $\xi = K \cdot \omega_0 \cdot B_1 \cdot M_0 \cdot V$ when K is an homogeneity factor, B_1 the alternative magnetic field and V the volume of the sample. In order to increase the B_1 magnetic value, a separate inductance from the detection coil was chosen. With a current of nearly 5 A in the generation inductance, $\xi = 14 \mu\text{V}$. By taking into account the bandwidth of the detection coil $\Delta f = 500 \text{ kHz}$, the spectral density of noise across this inductance is calculated: $e_n = 1,6 \cdot 10^{-10} \text{ V}$. With the noise factor of the preamplifier, the SNR is calculated: $\text{SNR} \cong 100$. In this calculus, the noise is underestimated because only the thermal noise from the detection coil and the noise from the LNA are take into account.

B. Spectrometer

Fig. 2 shows the functional schematic and the realization of the spectrometer used to control FID generation, acquisition and processing. A Cyclone III FPGA is used to control the FID record, acquisition time, sequence repetition time used for NMR, FID storage and transfer to the PC

using USB protocol. There are some daughter cards connected to the FPGA as shown in **Fig. 2**. The FPGA also ensures that the delivery signal parameters are correct.

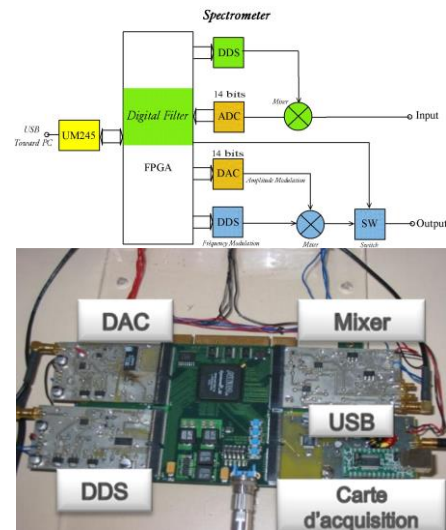

Fig. 2. Functional schematic and realization of the spectrometer

To digitize the FID, an ADC 14 bits - 65 MIPS is used. Then data are fed into the FPGA memory. After M samples of N points, the digital word is sent to the PC via USB port.

When the acquisition parameters are defined, the generated signal is sent by the DDS and an amplitude modulation is applied if necessary via the DAC. The amplitude and frequency modulation can be used to generate complex shapes of chirps in order to compensate the inhomogeneities of B_0 .

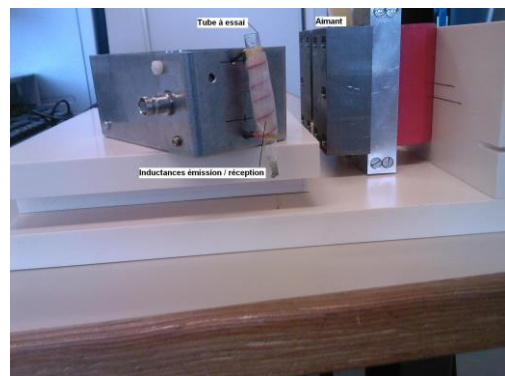

Fig. 3. Magnet and antenna connected to the duplexer

The magnet and the duplexer of the Fig. 3 were connected to the LNA and the PA.

Using two large pieces of steel, low inhomogeneities are expected. The sample of liquid of the Fig. 3 is placed inside the air gap of the magnet.

Fig. 4 shows an acquired signal with a superposed noise and the same signal with noise removed. This last signal is

generated by the treatment operated in the FPGA.

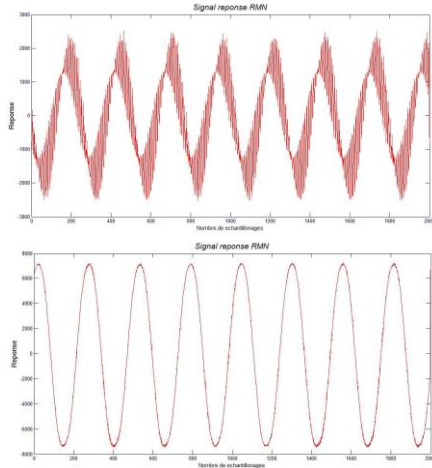

Fig. 4. Signal generated with and without the noise

Fig. 5 shows the shape of the signal generated from the spectrometer. We choose to deliver a sequence CPMG of three pulses $[\pi/2 \ \pi \ \pi]$ separated by $[t_2 \ t_4 \ t_6]$. Each times are programmed in the VHDL code of the FPGA.

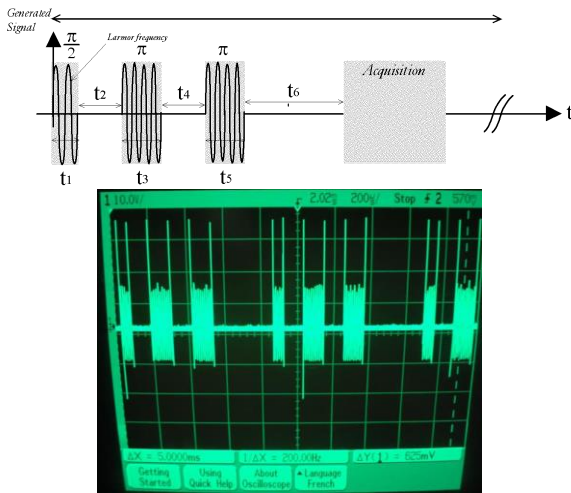

Fig. 5 : Shape of the generated signal from the spectrometer

II. MICROCOIL NMR

NMR micro coil represented in Fig. 6 detects the FID and is connected to the PCB for tuning and matching circuit. It is connected to the PCB for tuning and matching. Then, the signal is fed to an external amplifier. To improve the SNR, the resistance of the micro coil has to be very low. Therefore, the thickness of the copper used to realize the coil has to be thick so usually it uses electroplating. We optimize the electroplating process: flow of the electrolyte, current density, additive in the electrolyte in order to obtain

good aspect and good uniformity of the deposited layer.

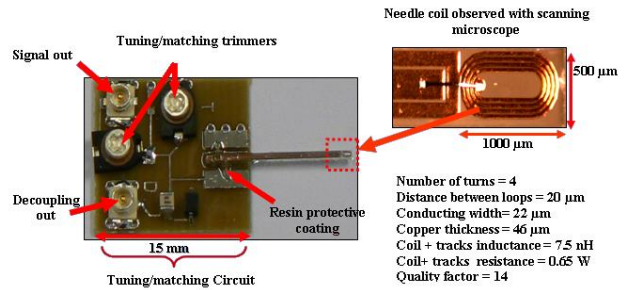

Fig. 6. Micro coil on the right and the PCB used to tune and match the signal

The process to deposit the thick resist is difficult to optimise because the thickness is around 50 μm. The resist have to be etched for 50 μm on a width of 20 μm. Thus, at the bottom of the hole, if there are some rests of the resist, the adherence of the cooper will be poor. It's this problem that we can see on the Fig. 7; there a lack of cooper inside the circle.

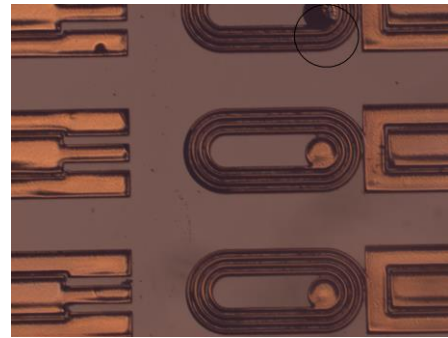

Fig. 7 : Photography of the microcoil NMR

The pattern represents in the Fig. 8 is used to verify that the resistivity of the layer copper deposited is correct. The thickness is 30 μm, the width is 42 μm and the total length of the pattern is about 10.9 mm. Thus resistivity calculation gives $\rho = 2,88.10^{-8} \Omega.m$. After bake at 150 °C during 30 minutes, the resistivity is $\rho = 2.10^{-8} \Omega.m$. It is not far from the theoretical copper resistivity $\rho = 1,72.10^{-8} \Omega.m$.

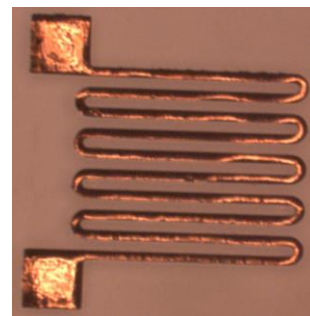

Fig. 8. Shape used to determine the resistivity of the electroplate copper



III. CONCLUSION

Two important parts necessary for NMR measurement are described in this paper. In the first part, a portable NMR apparatus is described. In the future, the array of magnets will be modified to reduce the inhomogeneities of B_0 . The running works concern also the achievement of PC supervisor linked to the Portable NMR device.

In the second part, the realization of a micro coil is described.

The two parts are designed to constitute an original NMR portable system for the analysis of low volumes samples.

A special thanks to the following students that worked on one part of this projet: LIMA MIGLIORINI Fabricio, ZHANG Shu and ZHANG Hao.

REFERENCES

- [1] E. Danieli, J. Mauler, J. Perlo, B. Blümich, F. Casanova, "Mobile sensor for high resolution NMR spectroscopy and imaging" *Journal of Magnetic Resonance* 198, 2009, pp 80-87.
- [2] C. Hugon, F. D'Amico, G. Aubert, D. Sakellariou, "Design of arbitrarily homogeneous permanent magnet systems for NMR and MRI: Theory and experimental developments of a simple portable magnet", *Journal of Magnetic Resonance* 205, 2010, pp75-85.
- [3] W-H Changa, J-H Chena, L-P Hwang "Single-sided mobile NMR with a Halbach magnet" in *Magnetic Resonance Imaging* 24, 2006, pp 1095-1102.
- [4] V. DEMAS, P. J. PRADO, "Compact Magnets for Magnetic Resonance", *Concepts in Magnetic Resonance PartA*, Vol. 34A(1), 2009, pp 48-59.
- [5] K. Takeda, "OPENCORE NMR: Open-source core modules for implementing an integrated FPGA-based NMR spectrometer", *Journal of Magnetic Resonance* 192, 2008, pp 218-229.
- [6] Baxan et al, C.R.Chim.2007.
- [7] Lacey et al, Chem.Rev.1999.
- [8] Kadjo , et al, ESMRMB, Valencia, 2008.

BIOGRAPHIE

Patrick Poulichet received his degree of electrical engineer at CNAM-Paris in 1998. He received the Ph.D. degree in Electrical Engineering from the École Normale Supérieure de Cachan (SATIE CNRS UMR 8029) in 2001. Since 1995, he has been with the Department of Electrical Engineering, at ESIEE (Ecole Supérieure d'Ingénieurs en Electronique et Electrotechnique) in France, as an Associate Professor. His research concerns portable NMR, integrated electronic and MEMS, and EMC.

Latifa Fakri-Bouchet received her Ph. D degree in the field of biomedical engineering from Lyon 1 university in 1996. Lastly she obtained the "habilitation" for Research Heading (HDR, 2008). Since 1995, she was assistant Professor (ATER), and then Associate Professor at Institut Universitaire de Technologie (IUT) of Lyon, and Laboratory CREATIS-LRMN UMR CNRS 5220, U630 INSERM, Université Lyon1 Claude Bernard, INSA de Lyon. Her main interest is in development of electronic circuits, and instrumentation dedicated to NMR biomedical applications, more particularly coils and micro coils design, and NMR instrumentation potentially leading to developments for clinical purposes and industrial applications.