

# Radiative and Ablative Studies for In-Flight Validation on Reentry Platforms

-5<sup>th</sup> PhD Symposium, VKI, 2014-

G. Bailet

*Aeronautics & Aerospace Dept., von Karman Institute for Fluid Dynamics*

Promotor: Ch. Laux

EM2C, Ecole Centrale Paris

Supervisors: J. Muylaert (QARMAN) and T. Magin (CIFRE)

*Aeronautics & Aerospace Dept., von Karman Institute for Fluid Dynamics*

Industrial partners (Astrium Space Transportation):  
Alexis Bourgoing, Franck Delattre and Coumar Oudea



# Content

- Introduction
- QARMAN Platform
- Spectrometer payload
- Conclusion and future work

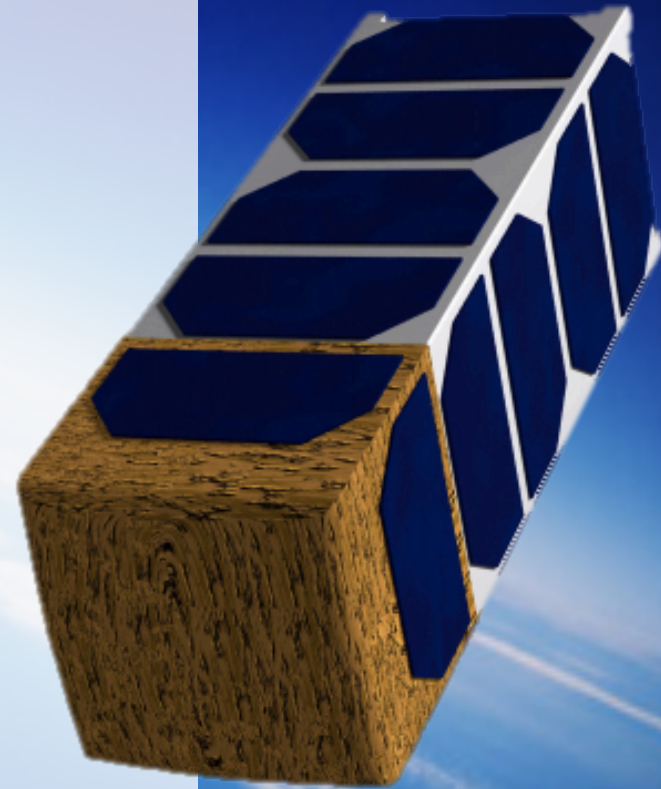

# Introduction

-[www.qb50.eu](http://www.qb50.eu)-

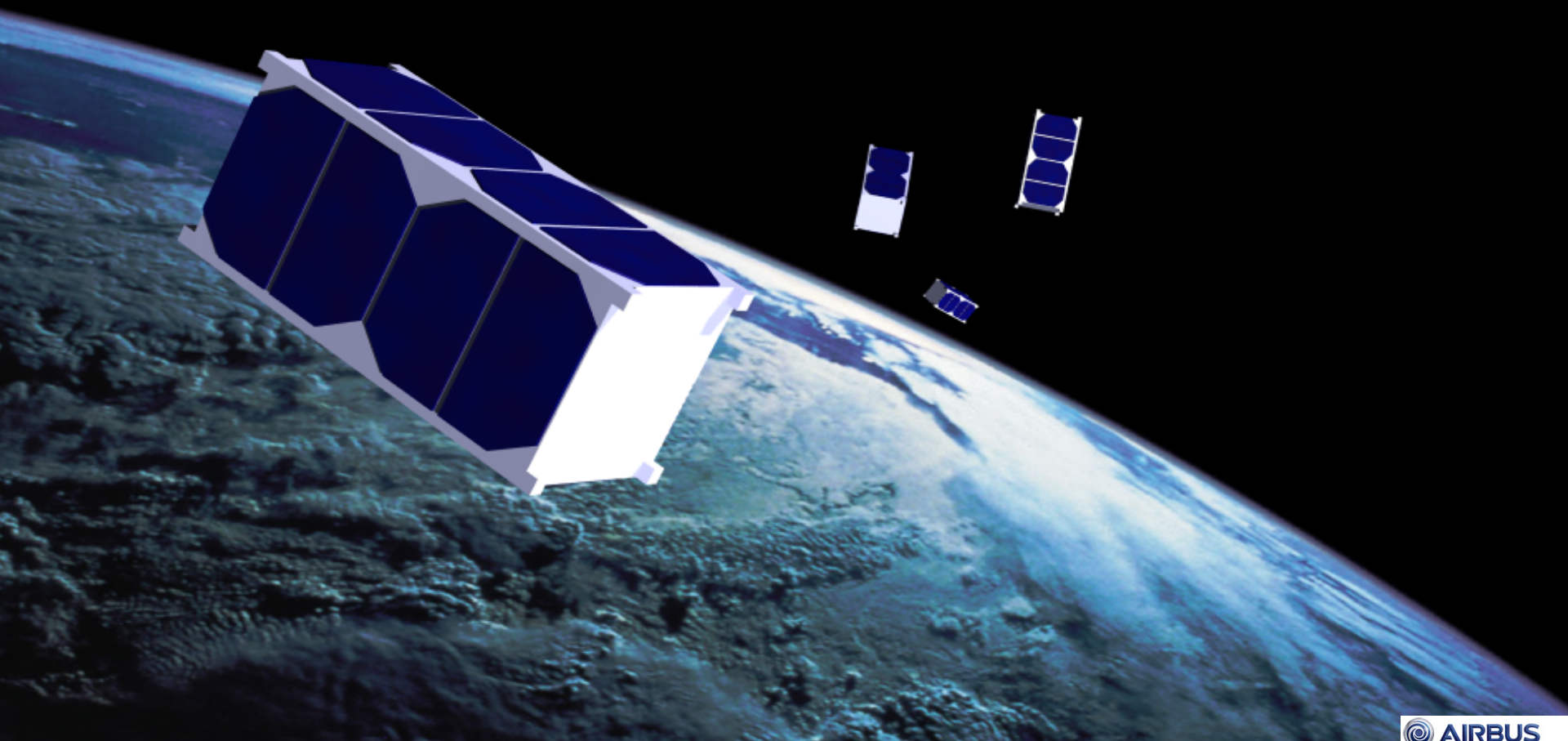

- Sint-Genesius-Rode, March 12<sup>th</sup> 2014 -



# Introduction

-QB50-

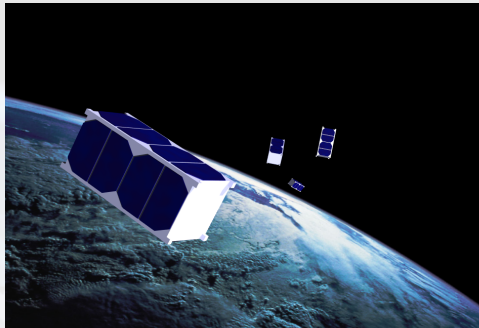

- **Study of the lower thermosphere**
  - In-situ
  - 3 month duration mission
  - Network of 40 double CubeSats
- **10 triple CubeSats for in-orbit demonstration**
  - End-of-life analysis, debris
  - Formation flight
  - Micro-propulsion system
  - Micro-g experiment
  - Solar sail
  - **Flight demonstrator: QARMAN**
    - **TPS**
    - **Instrumentation**

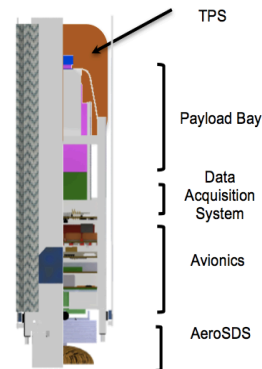
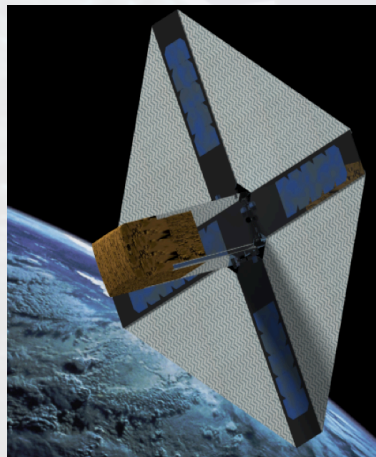

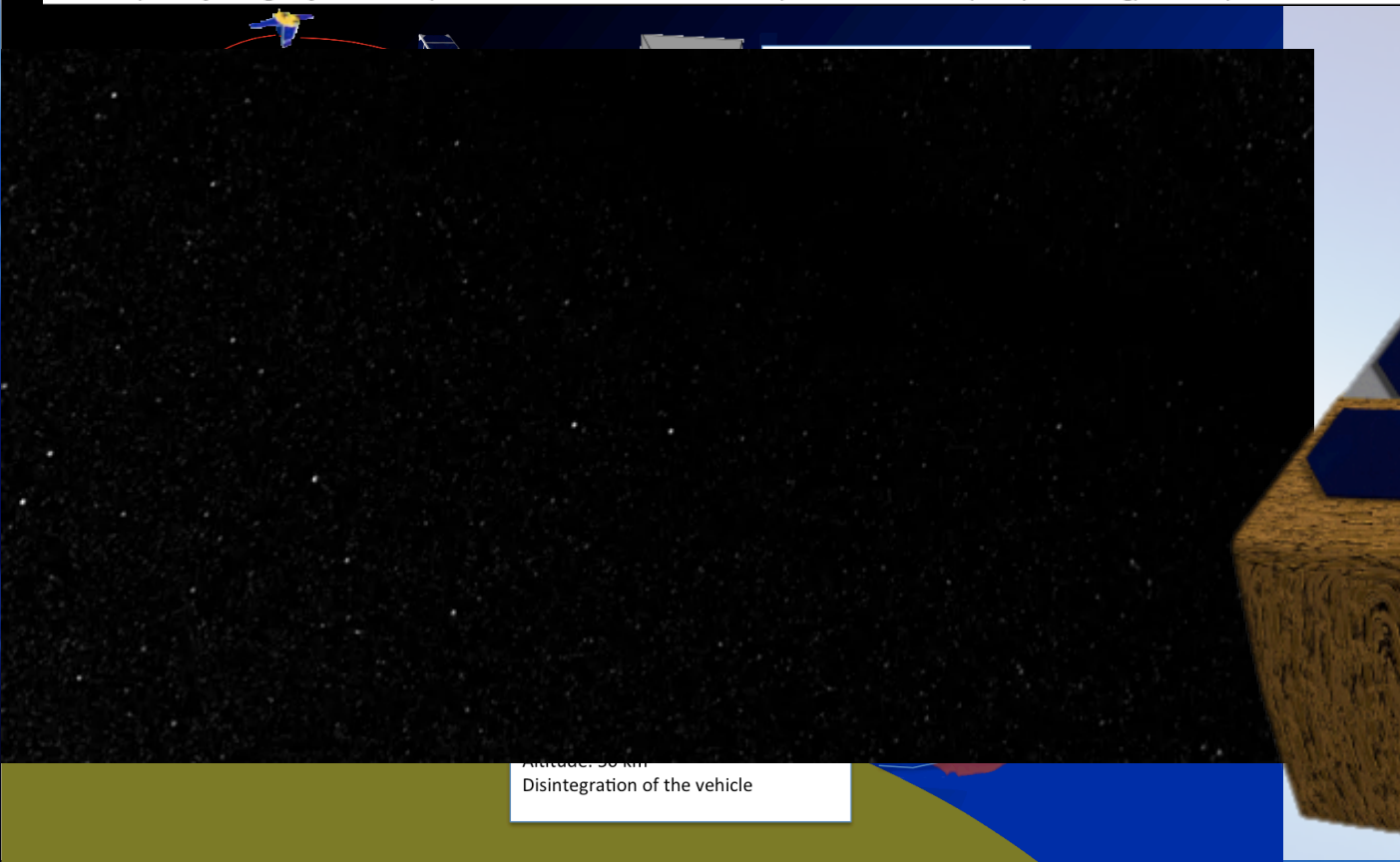
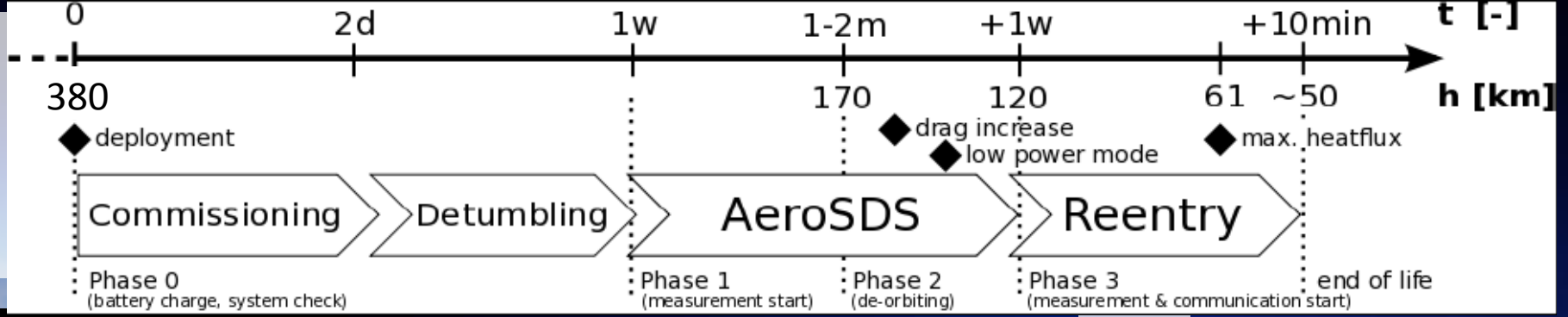

Altitude: 50 km  
Disintegration of the vehicle

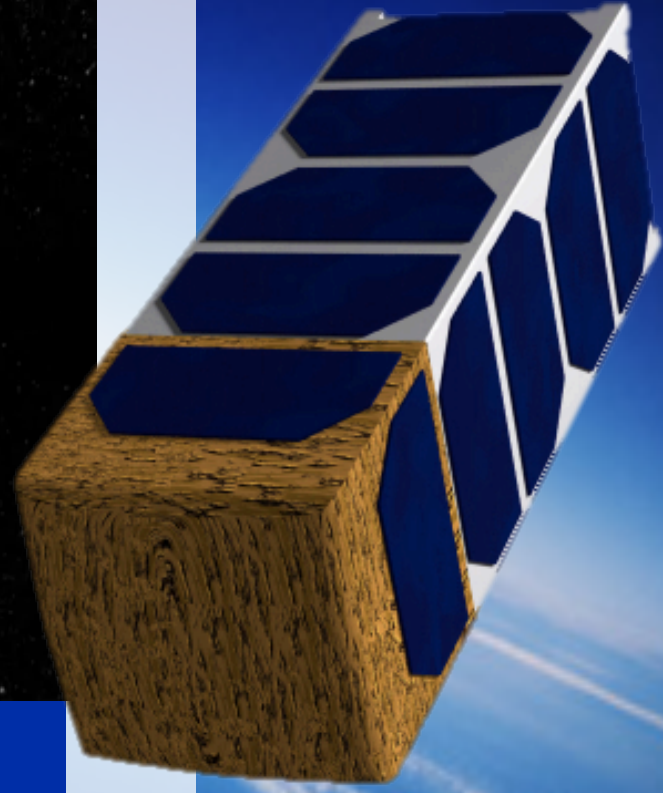

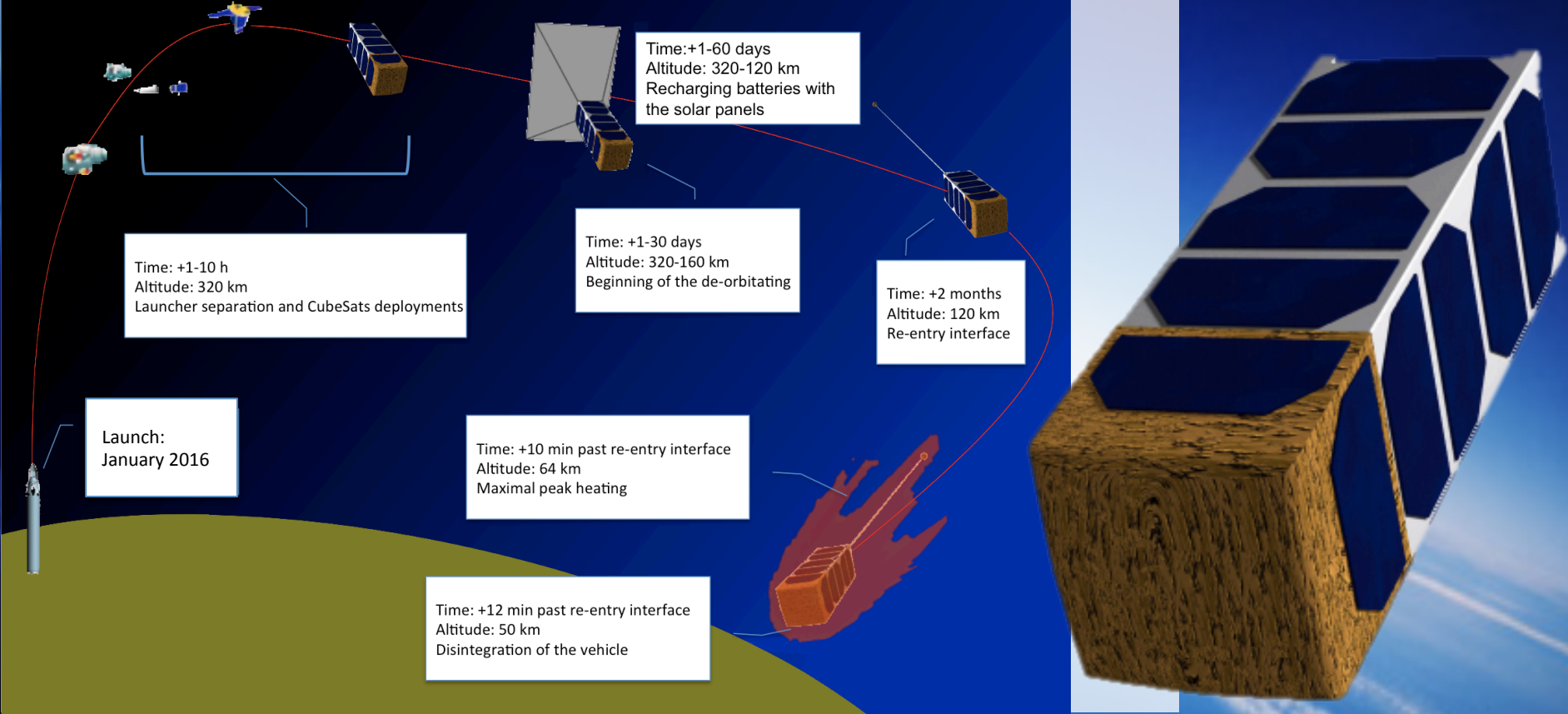
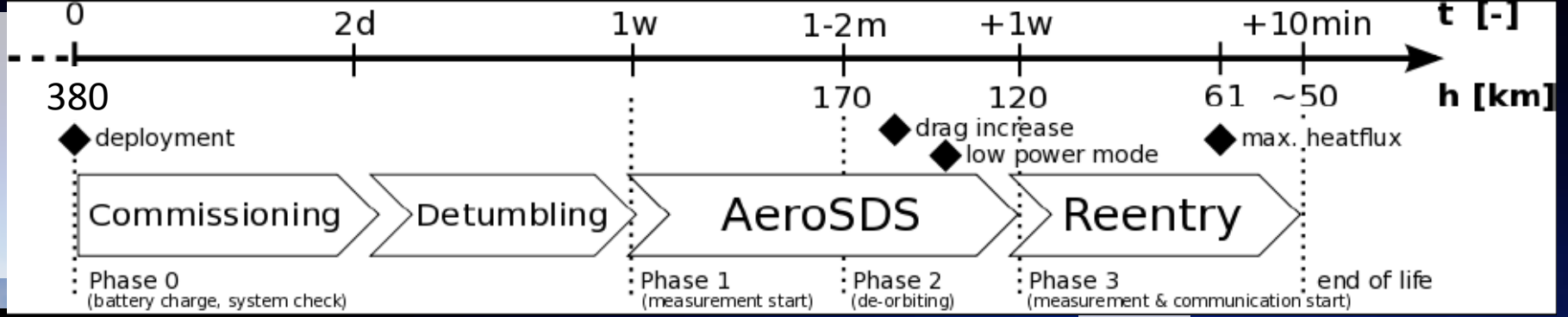

# QARMAN Platform

-Preliminary design-

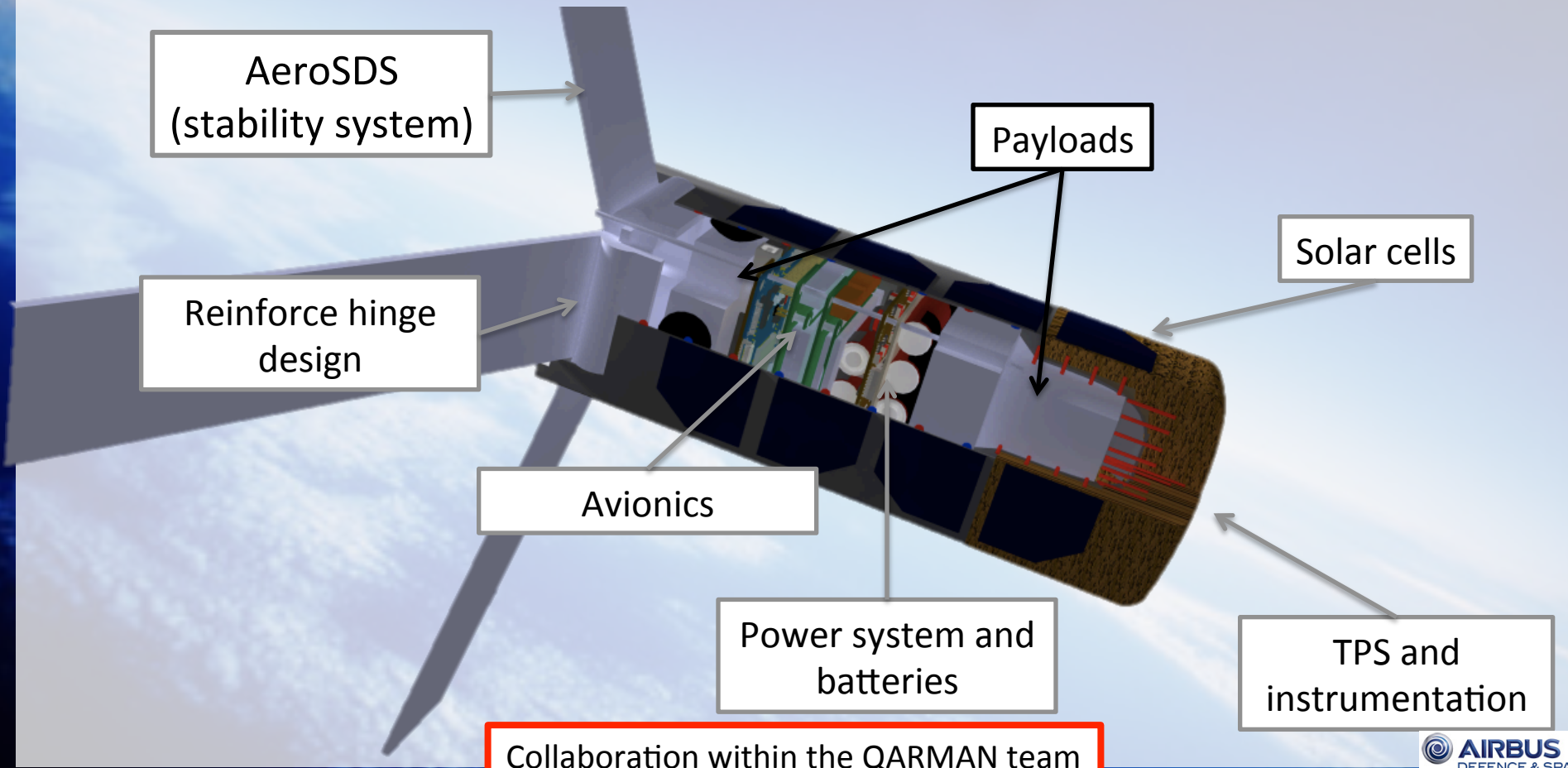

Collaboration within the QARMAN team



- Sint-Genesius-Rode, March 12<sup>th</sup> 2014 -

# QARMAN Platform

-Preliminary design-

Reference: QARMAN proposal for QB50 call

Subsystem	Mass [g], [%]		Volume [10cm], [%]	
<b>Heat Shield</b>				
Front surface	360	20	0.63	25
Side-Panels	217	20	n/a	0
<b>Functional Unit</b>				
Structure (2U)	468	20	n/a	
OBC	161	10	0.17	10
EPS + Batteries	248	10	0.33	25
Solar Panels	336	5	n/a	
Communication	263	10	0.46	10
<b>Payloads</b>				
Acquisition PCB	240	20	0.25	25
Sensors	469	20	0.25	25
AeroSDS	300	20	0.5	25
<b>Total</b>	<b>3062</b>		<b>2.59</b>	

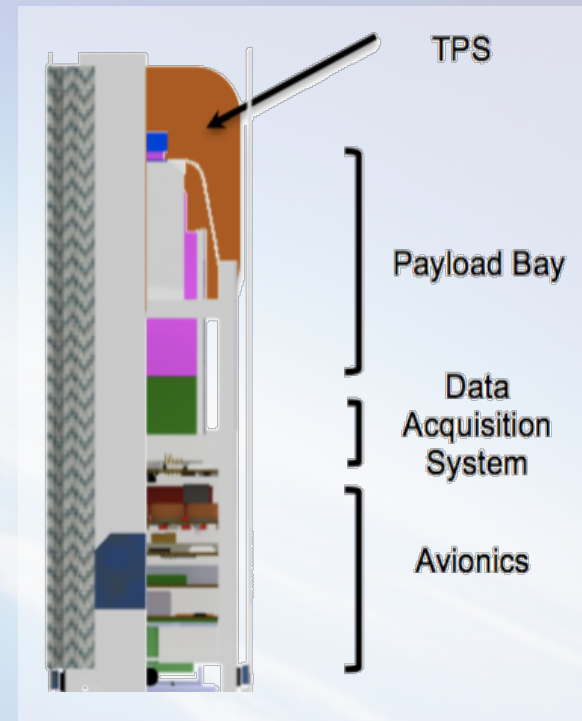



# QARMAN Platform

-Preliminary design-

Reference: QARMAN proposal for QB50 call

Subsystem	Mass [g], [%]		Volume [10cm], [%]	
<b>Heat Shield</b>				
Front surface	360	20	0.63	25
Side-Panels	217	20	n/a	0
<b>Functional Unit</b>				
Structure (2U)	468	20	n/a	
OBC	161	10	0.17	10
EPS + Batteries	248	10	0.33	25
Solar Panels	336	5	n/a	
Communication	263	10	0.46	10
<b>Payloads</b>				
Acquisition PCB	240	20	0.25	25
Sensors	469	20	0.25	25
AeroSDS	300	20	0.5	25
<b>Total</b>	<b>3062</b>		<b>2.59</b>	

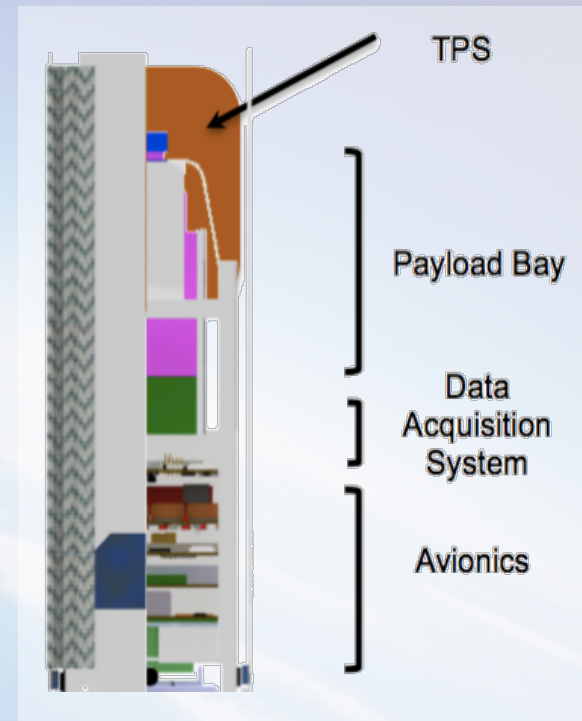

# QARMAN Platform

-Payloads-

Reference: QARMAN proposal for QB50 call

Investigated Challenge	Parameter to measure	Sensor	Total Mass [kg]	Power [mW h]	Data Size / Meas. [bit]	Phase	Total Data Size [KB/Phase]
TPS Ablation	Recession	2 x Recession Sensor	0,004	1.67	10	3	3.0
TPS Efficiency	Temperature Distribution	8 x TC	0,031	1.67	14	3	16.8
TPS & Environment	Pressure	2 x Pressure Sensor	0.060	8.33	10	3	3.0
Stability	Pressure	4 x Pressure Sensor	0,060	840	10	2	302.4
Rarified Flow Conditions	Low Pressure / Vacuum	1 x Vacuum Sensor	0,011	756	10	1	151.2
				756		2	151.2
Shear Force, Laminar to Turbulence Transition	Skin Friction	2 x Preston Tube	0.120	2520	10	2	907.2
				16.67		3	3.0
Off-Stagnation Temperature Evolution	Temperature	10 x TC	0,021	16.8	14	2	211.68
				1.67		3	21.0
Aerothermodynamic Environment	Species	1 x Spectrometer	0,084	6250	28	3	3.5
<b>Total</b>			<b>0.391</b>	<b>6250</b>	<b>338</b>		

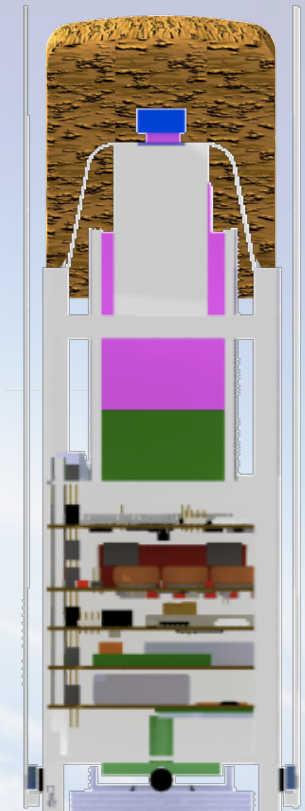

# Spectrometer Payload

-What is emission spectrometry?-

## Energy Level Diagram

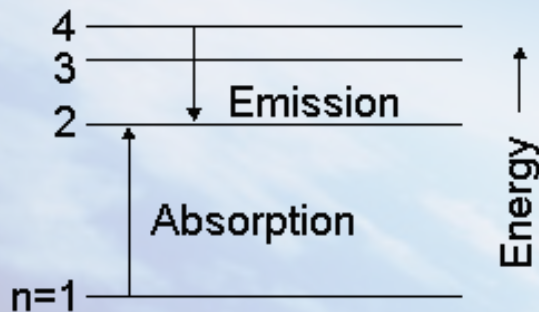

A schematic representation of the orbital energy levels.

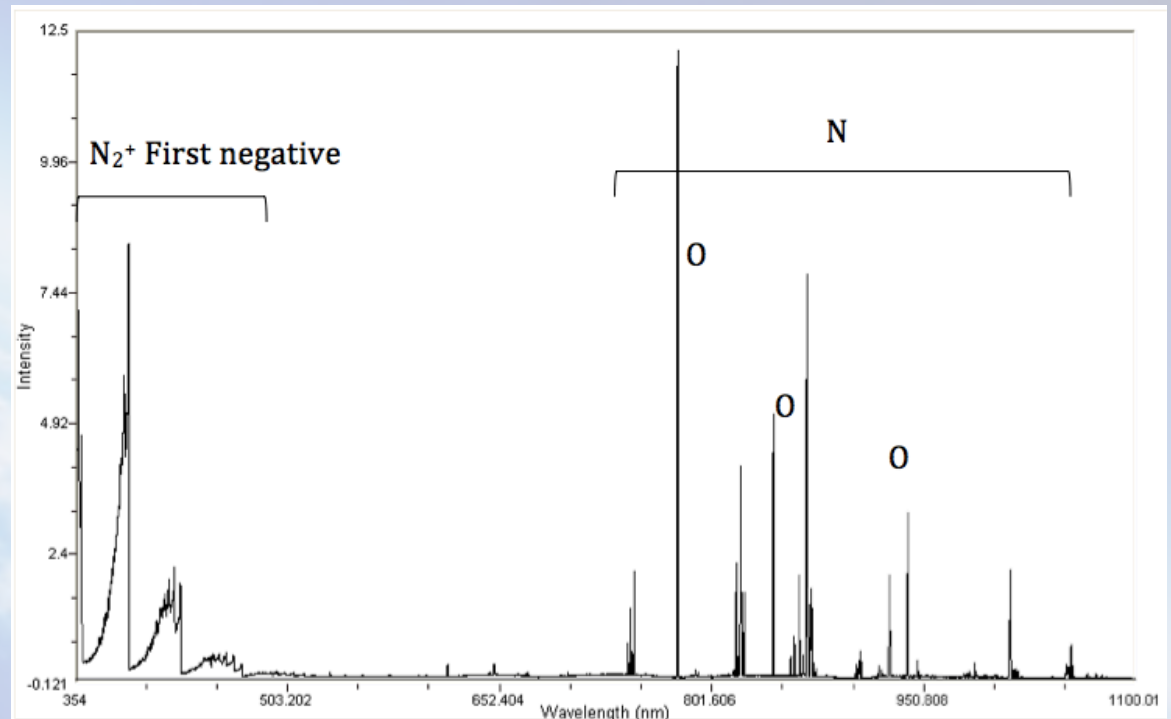

Each photonic emission has a specific energy (i.e. a specific wavelength)

# Spectrometer Payload

-What is emission spectrometry?-

## Energy Level Diagram

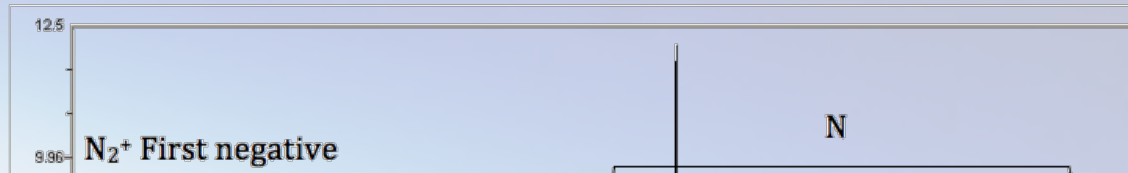
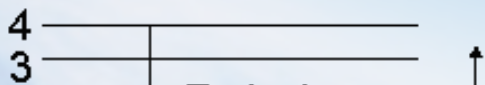

Molecular systems and atomic lines give info on:  
Rovibronic temperatures, species concentration,  
energy level population, equilibrium/non-equilibrium  
energy level population...

A schematic  
representation of the  
orbital energy levels.

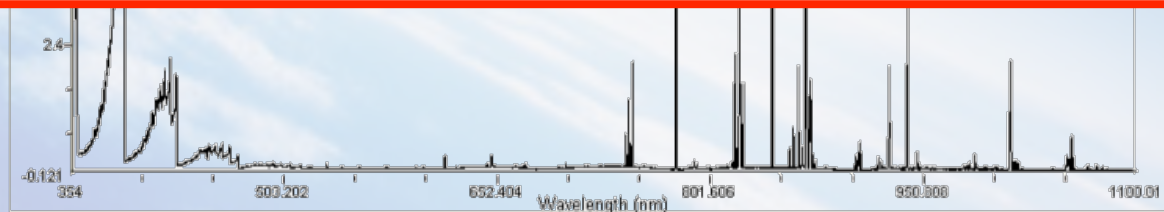

Each photonic emission has a specific energy  
(i.e. a specific wavelength)

# Spectrometer Payload

-Flight heritage-

## FIRE - Flight Investigation of the Reentry Environment

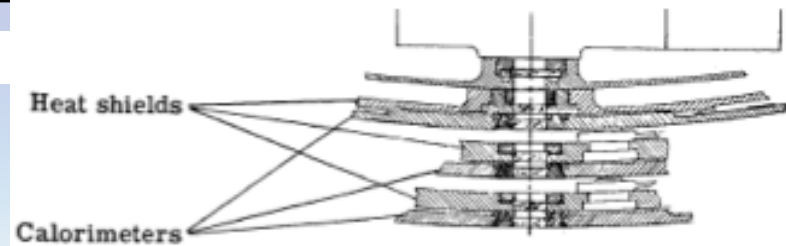

Cauchon, D. L., Radiative Heating Results from the FIRE II Flight Experiment at a Re-entry Velocity of 11.4 Kilometers per Second, TM X-1402, NASA, 1967.

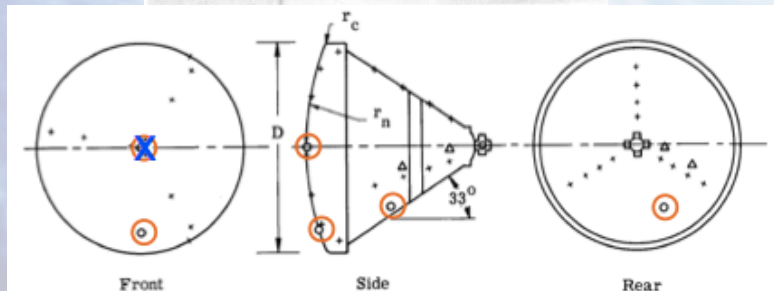

Cauchon, D. L., Radiative Heating Results from the FIRE II Flight Experiment at a Re-entry Velocity of 11.4 Kilometers per Second, TM X-1402, NASA, 1967.

Data Period	Altitude / km	Velocity / km/s
<b>Fire I</b>		
1	89.01 – 70.00	11.63 – 11.53
<b>Fire II</b>		
1	83.75 – 69.80	11.37 – 11.30
2	54.34 – 53.23	10.61 – 10.51
3	41.80 – 40.75	8.20 – 7.74

# Spectrometer Payload

-Flight heritage-

## Bow Shock UV & UV Diagnostics Experiment

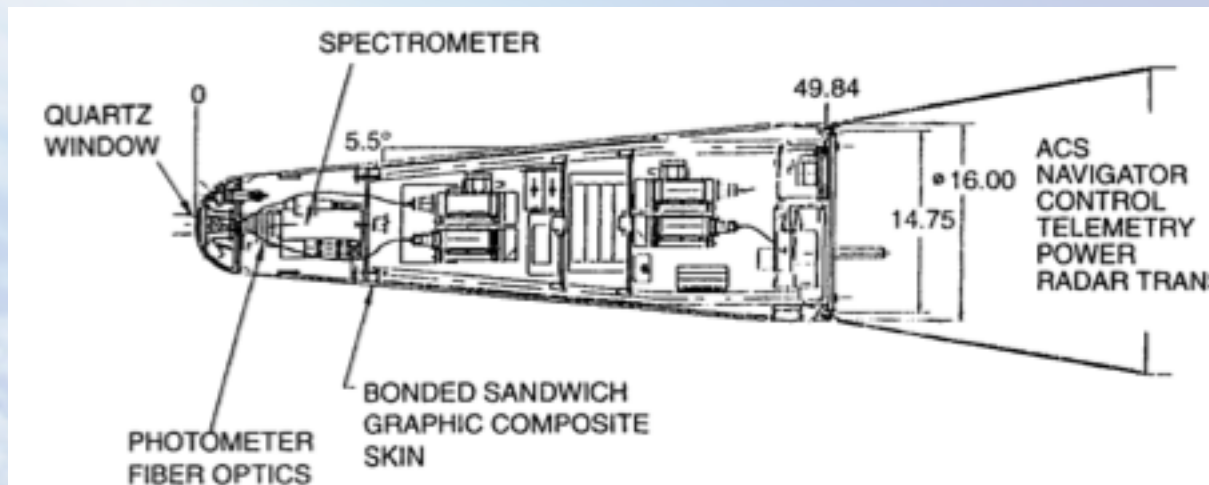

Erdman, et al, Measurement of Ultraviolet Radiation from a 5-km/s Bow Shock, *Journal of Thermo-physics and Heat Transfer*, Vol. 8, No. 3, 1994

# Spectrometer Payload

-Flight heritage-

Mission	Year	Entry speed [km.s <sup>-1</sup> ]	Altitude range [km]	Spectral range [nm]	Spectral resolution [nm]	Focus
FIRE I	1964	11.5	70-89	300-600	4	Coupled ablation/ radiation
FIRE II	1965	11.5	40-83	300-600	4	Coupled ablation/ radiation
BSUV I	1990	3.5	38-70	200-400	1	UV diagnostic
BSUV II (UVDE)	1991	5.1	62-110	200-400	1	UV diagnostic
Ground observations (Stardust, ATV 1 and Hayabusa)	2006	>12	?	300-2000	0.1-20	Global observation
	2008	7.8				
	2010	>12				
EXPERT	2013?	5	?	200-850	1.5	Build a database
QARMAN	2015	7.6-7.8	50-120	200-1100	0.8-1.5	

# Spectrometer Payload

-Design methodology-

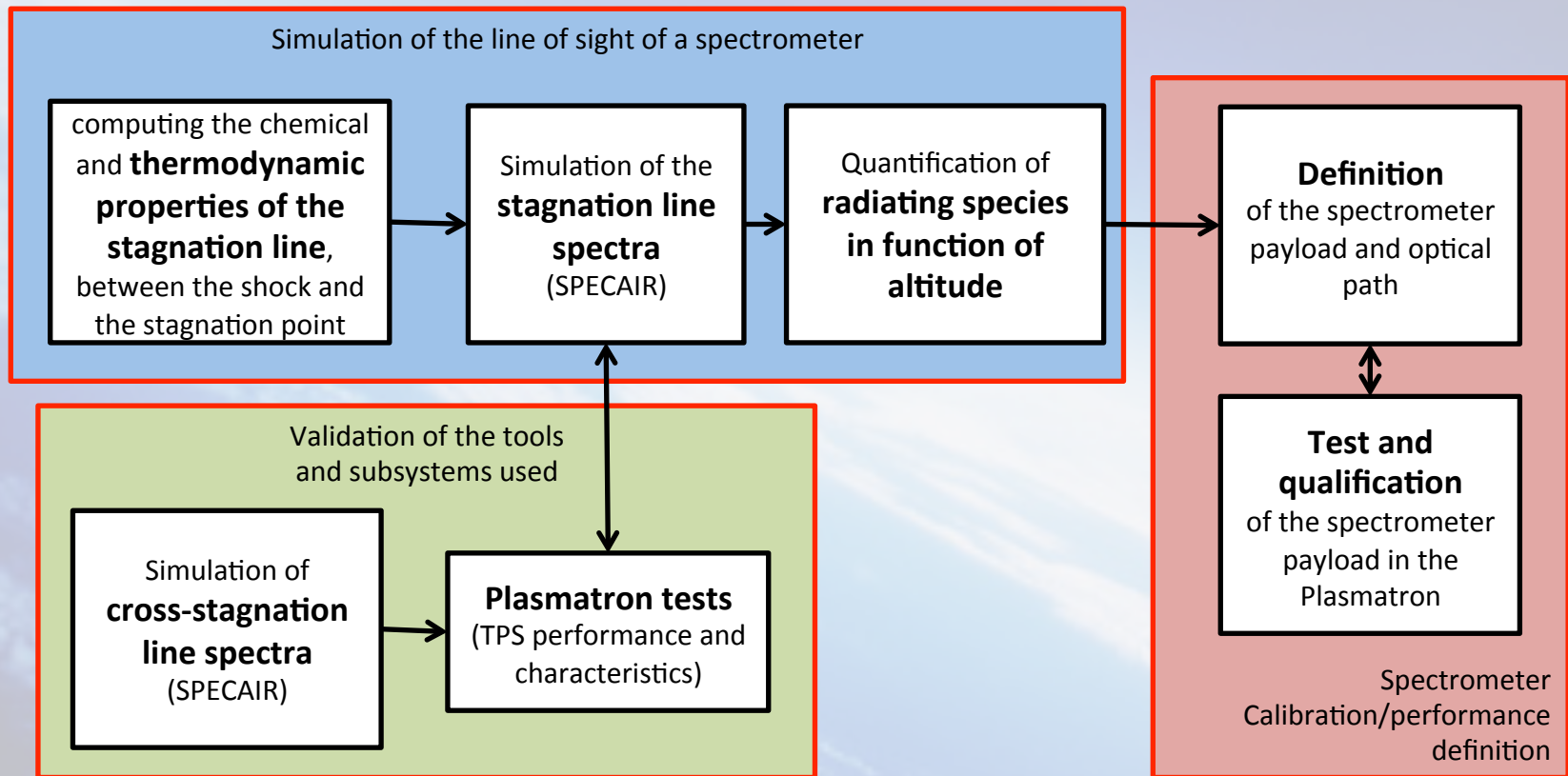



# Spectrometer Payload

-Design methodology-

Simulation of the line of sight of a spectrometer

computing the chemical and **thermodynamic properties of the stagnation line**, between the shock and the stagnation point

Simulation of the **stagnation line spectra** (SPECAIR)

Quantification of **radiating species in function of altitude**

# Spectrometer Payload

-Prediction-

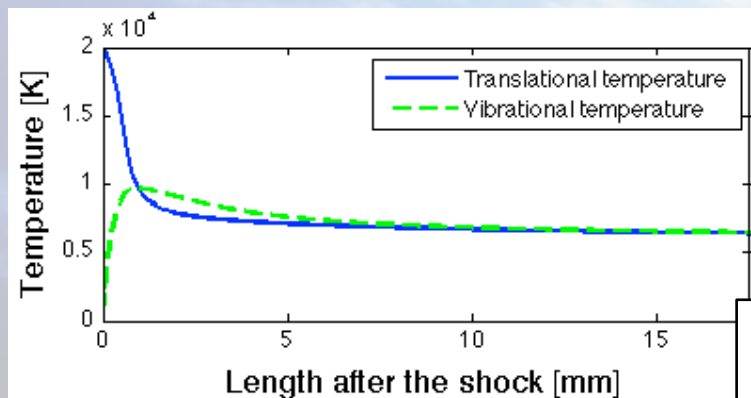
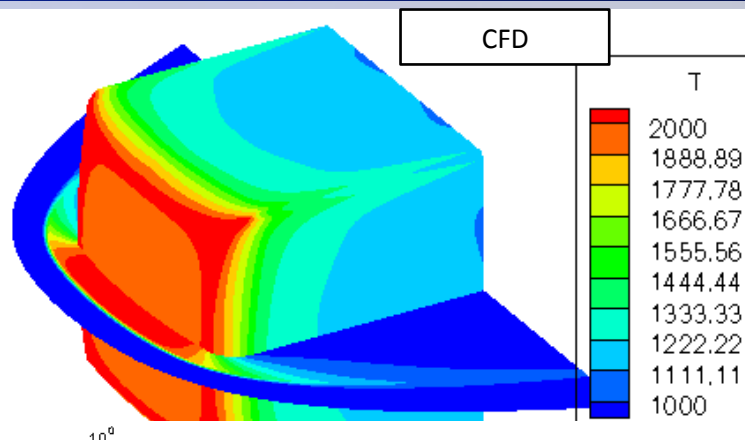
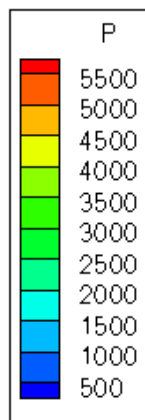
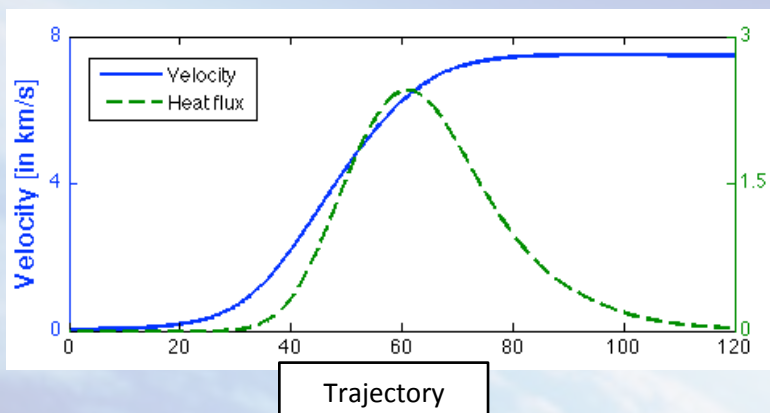

Thermal and Chemical properties of the stagnation line

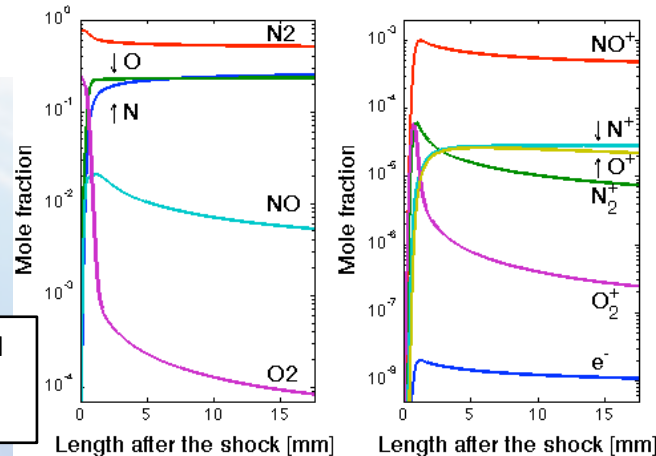

Steps leading to the calculus of Line-of-sight's radiations at a given altitude

# Spectrometer Payload

-Prediction-

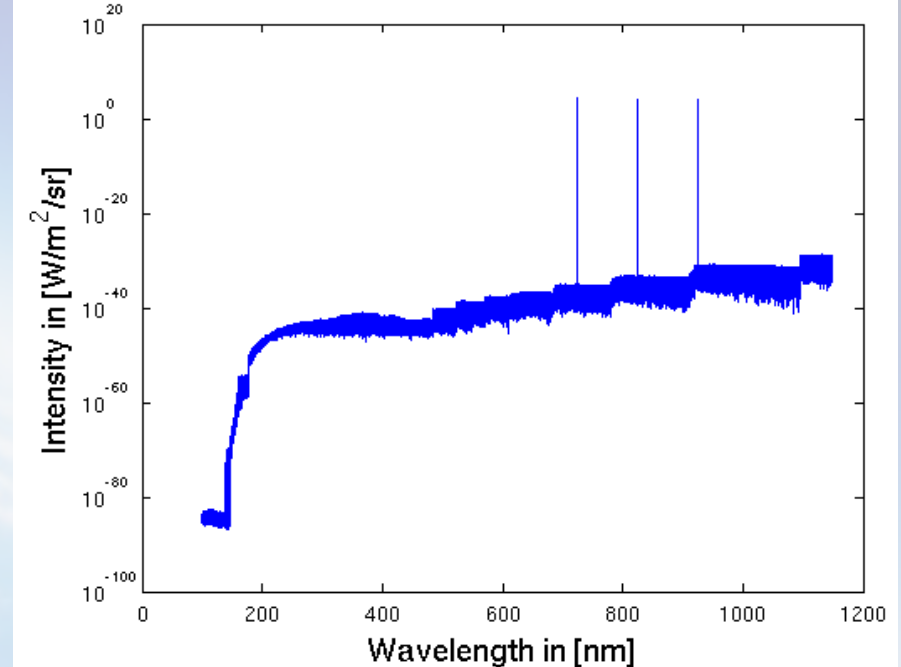
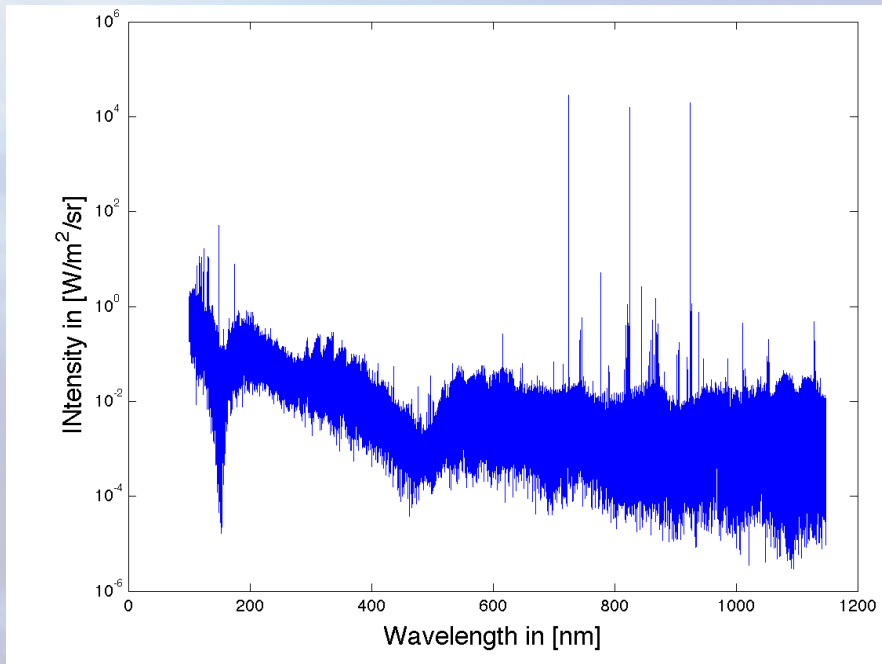

Emission spectra calculated at 60km(left) and 120km(right) with SPECAIR considering radiation transport through “Thick” plasma between 150 and 1150 nm

# Spectrometer Payload

-Prediction-

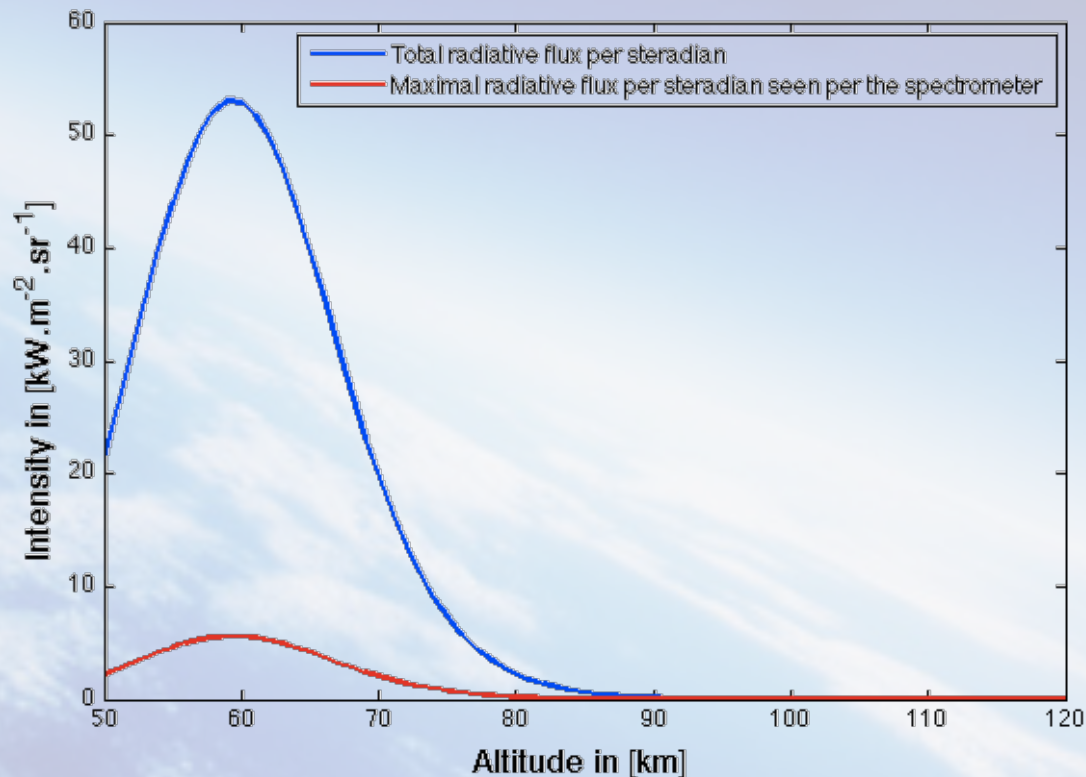

Emitted intensity from the stagnation line perceived by the virtual spectrometer between 20 and 2000 nm along the trajectory considering fine plasma approximation (without any filter, top curve; with 50 mm thick sapphire window, down curve)

# Spectrometer Payload

-Prediction-

Shock:  $N_2^+$

O

NONON

N N

O

TPS: CN

Na

H

(C)

(C)

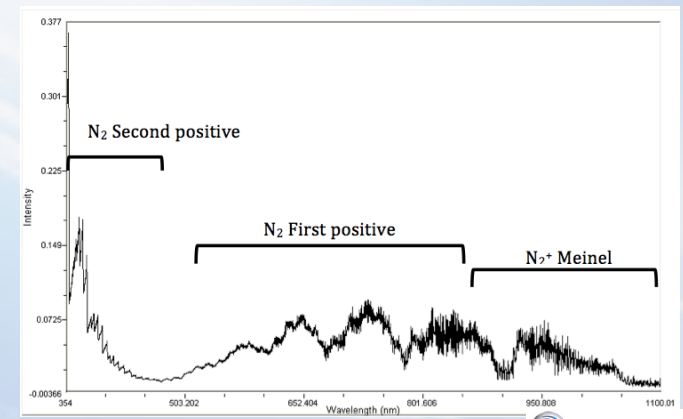
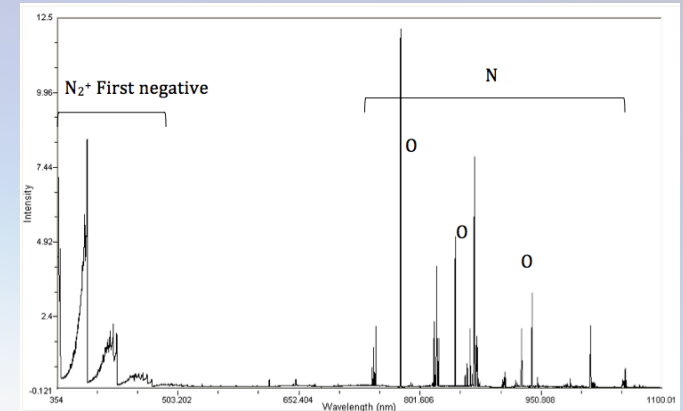
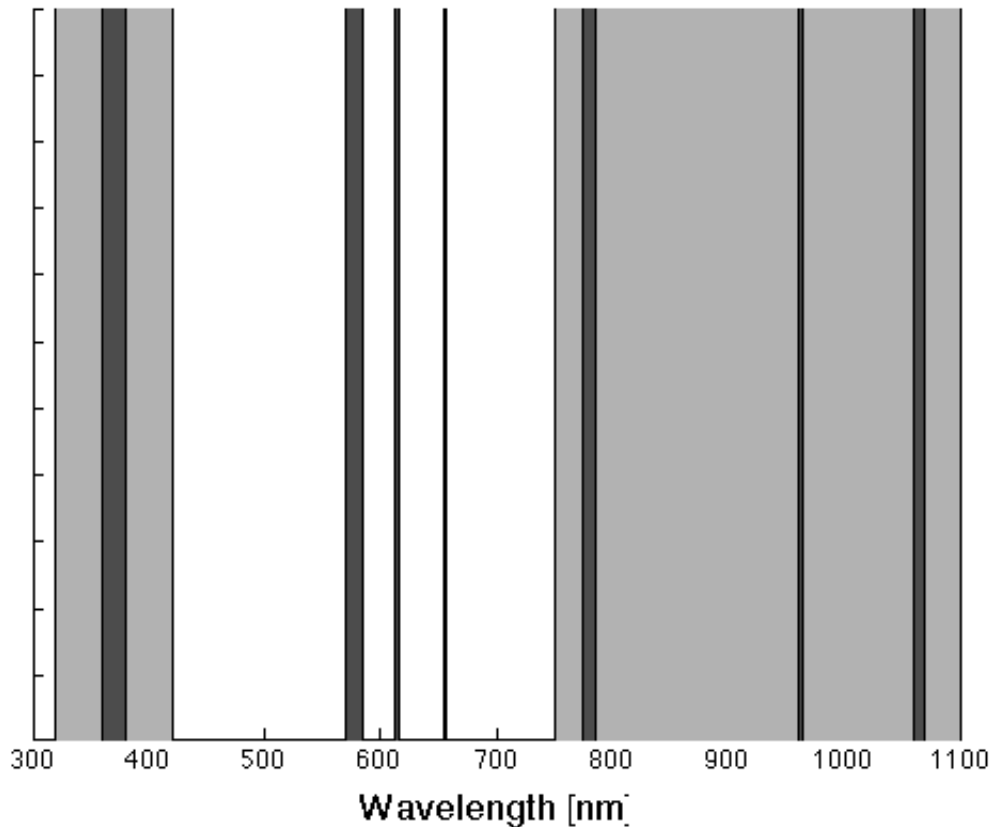

# Spectrometer Payload

-Prediction-

Shock:  $N_2^+$

O

NONON

N N

O

TPS: CN

Na

H

(C)

(C)

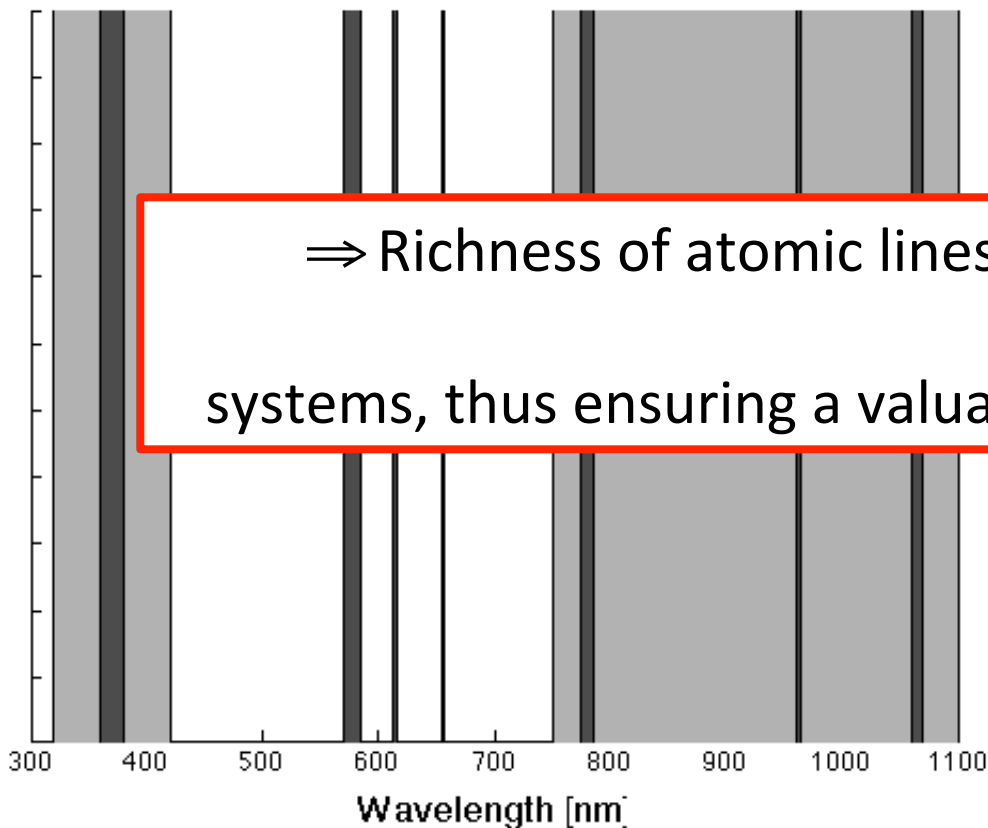

⇒ Richness of atomic lines and molecular systems, thus ensuring a valuable scientific return

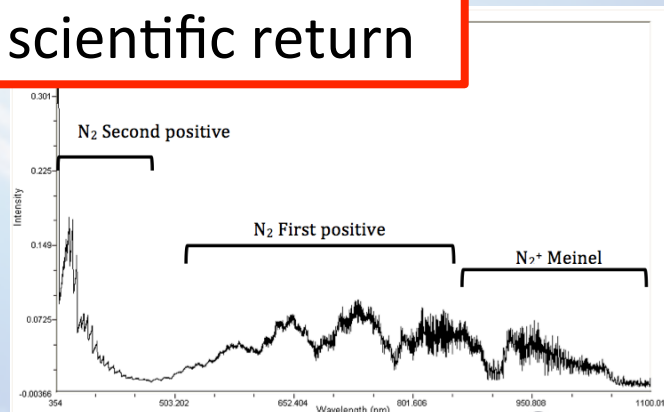
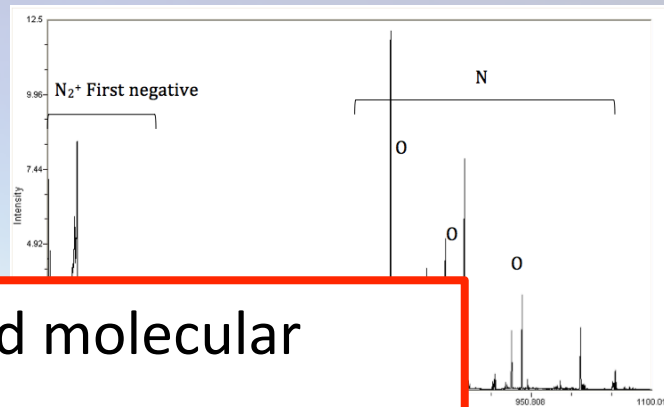

# Spectrometer Payload

-Selection methodology-

Shock: N<sub>2</sub><sup>+</sup>

O

NONON N N

O

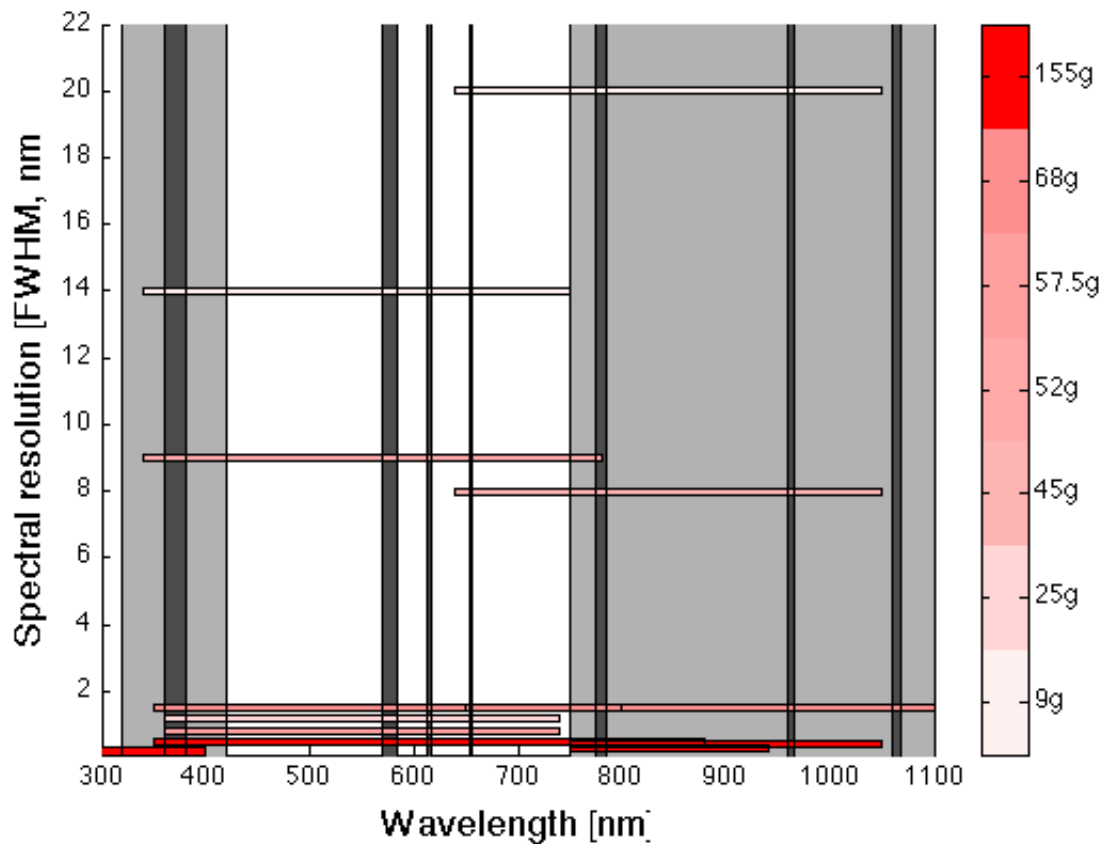

## Names

- Qwave
- STS - VIS
- STS - NIR
- Qmini
- C11009MA
- C11010MA
- Qstick
- C10988MA
- C11708MA

# Spectrometer Payload

-Selection methodology-

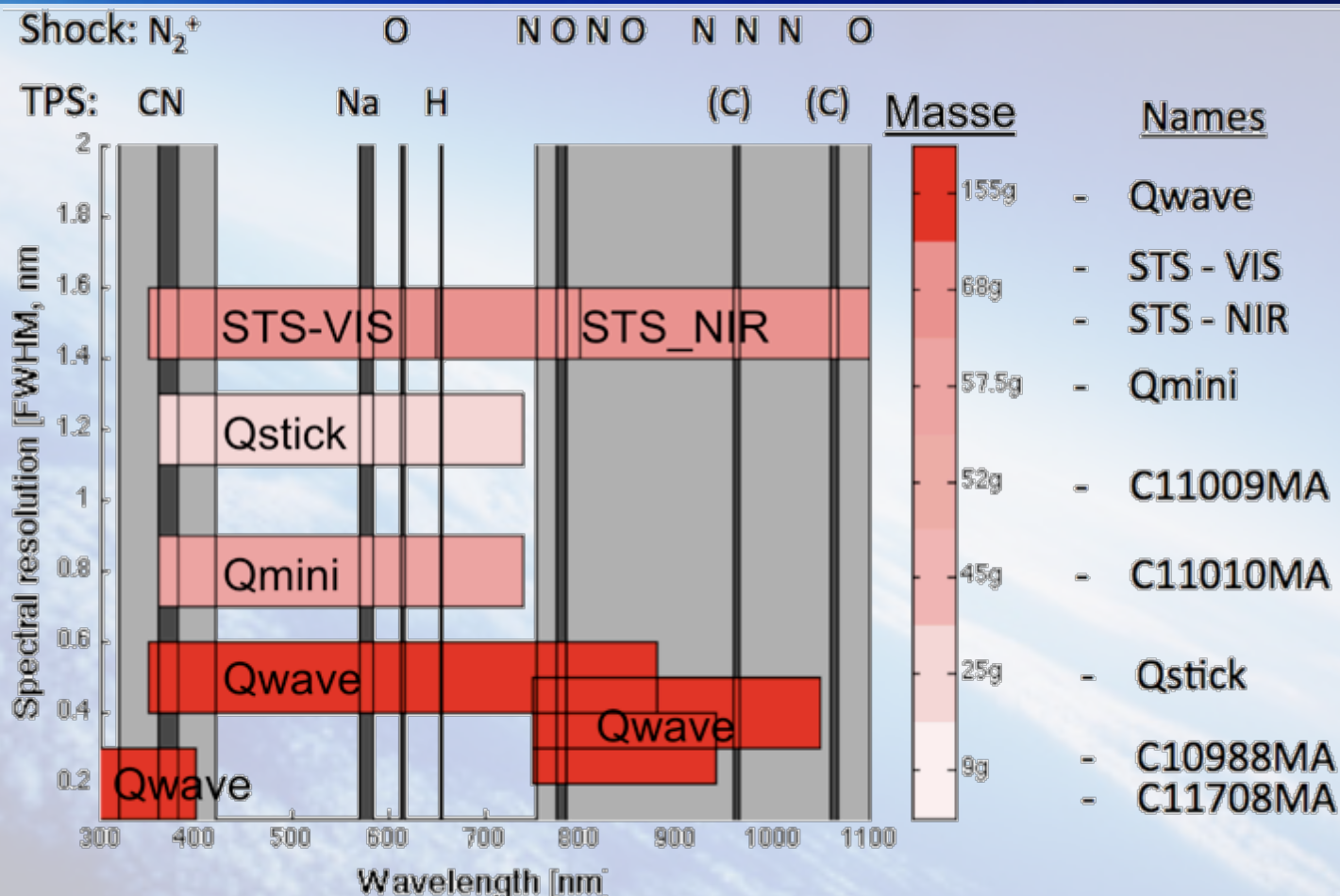



# Spectrometer Payload

-Selection methodology-

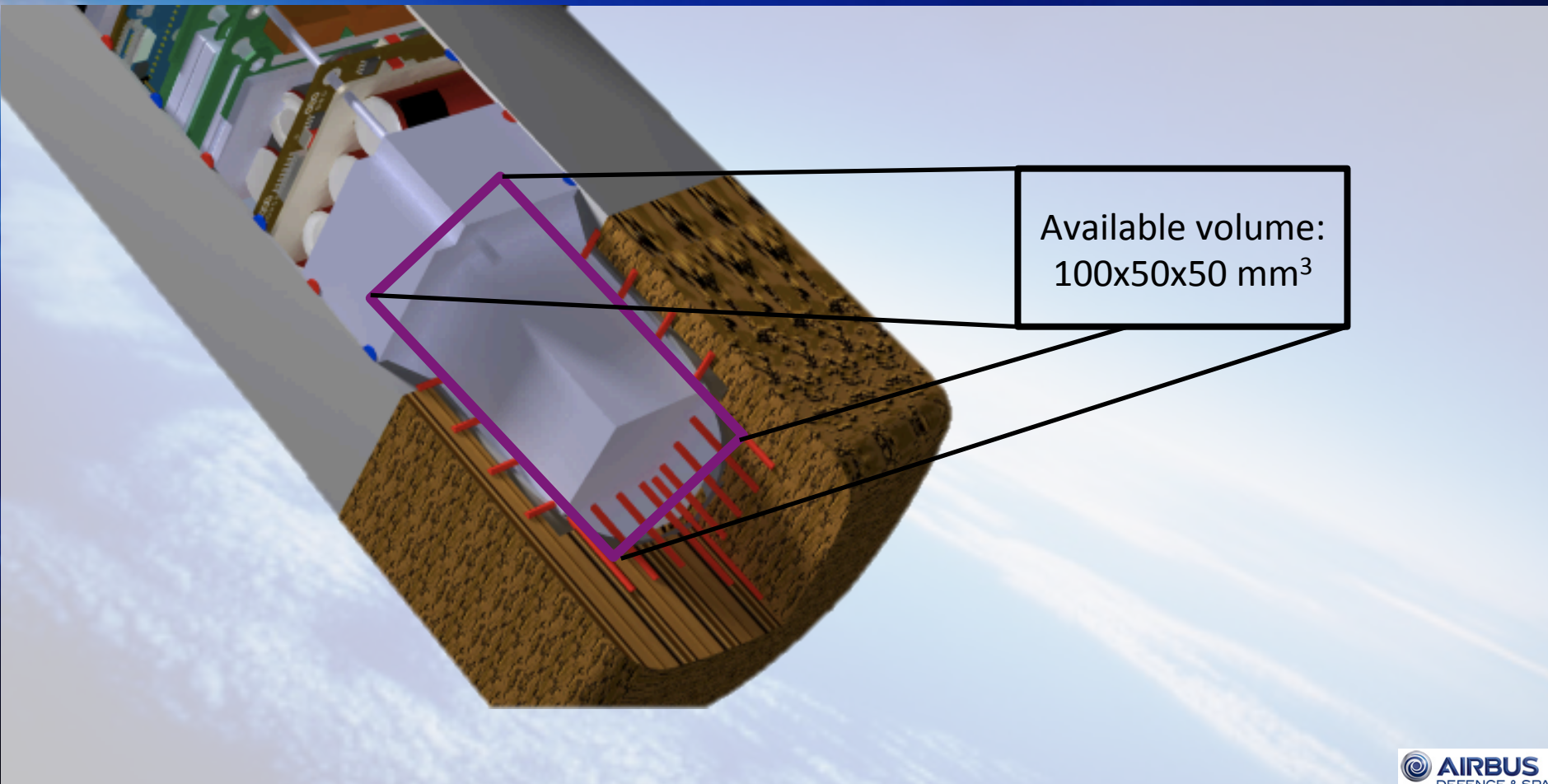

Available volume:  
100x50x50 mm<sup>3</sup>

# Spectrometer Payload

-Selection methodology-



## STS-VIS

Dimensions:

**40x42x24 cm<sup>3</sup>**

Weight:

**68 g**

Wavelength range:

**350-800 nm**

Spectral resolution:

**1.5 nm**



## Qmini

Dimensions:

**62x42x14.8 cm<sup>3</sup>**

Weight:

**57.5 g**

Wavelength range:

**360-740 nm**

Spectral resolution:

**0.8 nm**



## Qstick

Dimensions:

**85.7x22x10 cm<sup>3</sup>**

Weight:

**25 g**

Wavelength range:

**360-740 nm**

Spectral resolution:

**1.2 nm**

# Spectrometer Payload

-Selection methodology-



## STS-VIS

Dimensions:

**40x42x24 cm<sup>3</sup>**

Weight:

**68 g**

Wavelength range:

**350-800 nm**

Spectral resolution:

**1.5 nm**

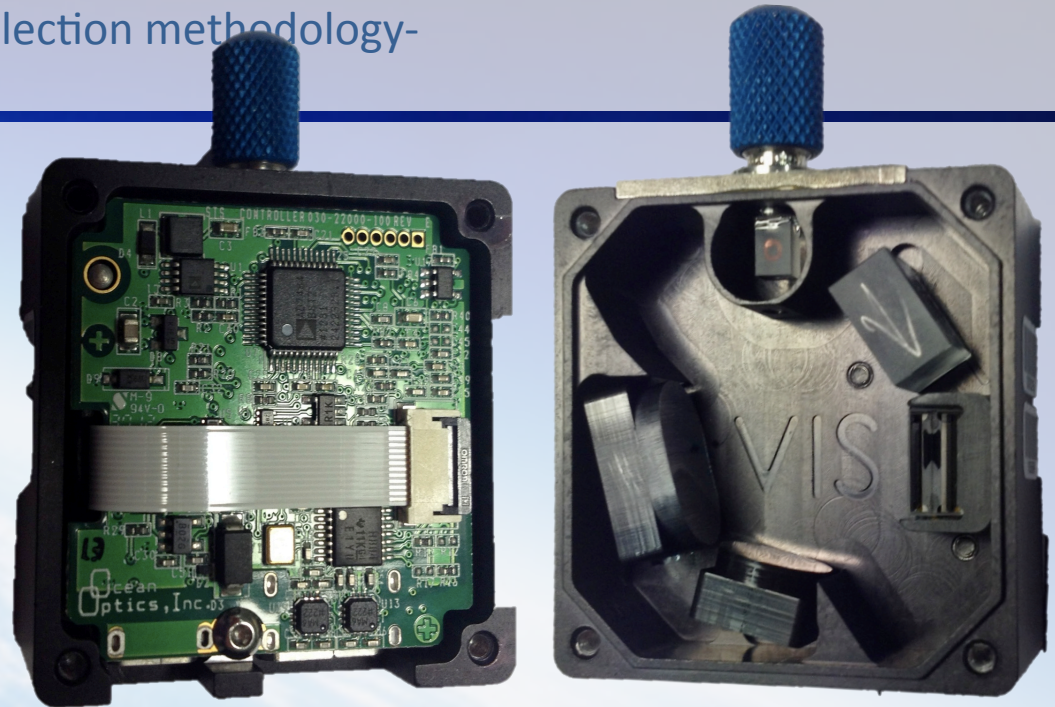

Suitable for the selected spectral range/resolution

Suitable for the form factor/mass requirement

Brand selected for EXPERT (RESPECT payload) mission

# Spectrometer Payload

-Measurement in an ablation environment-

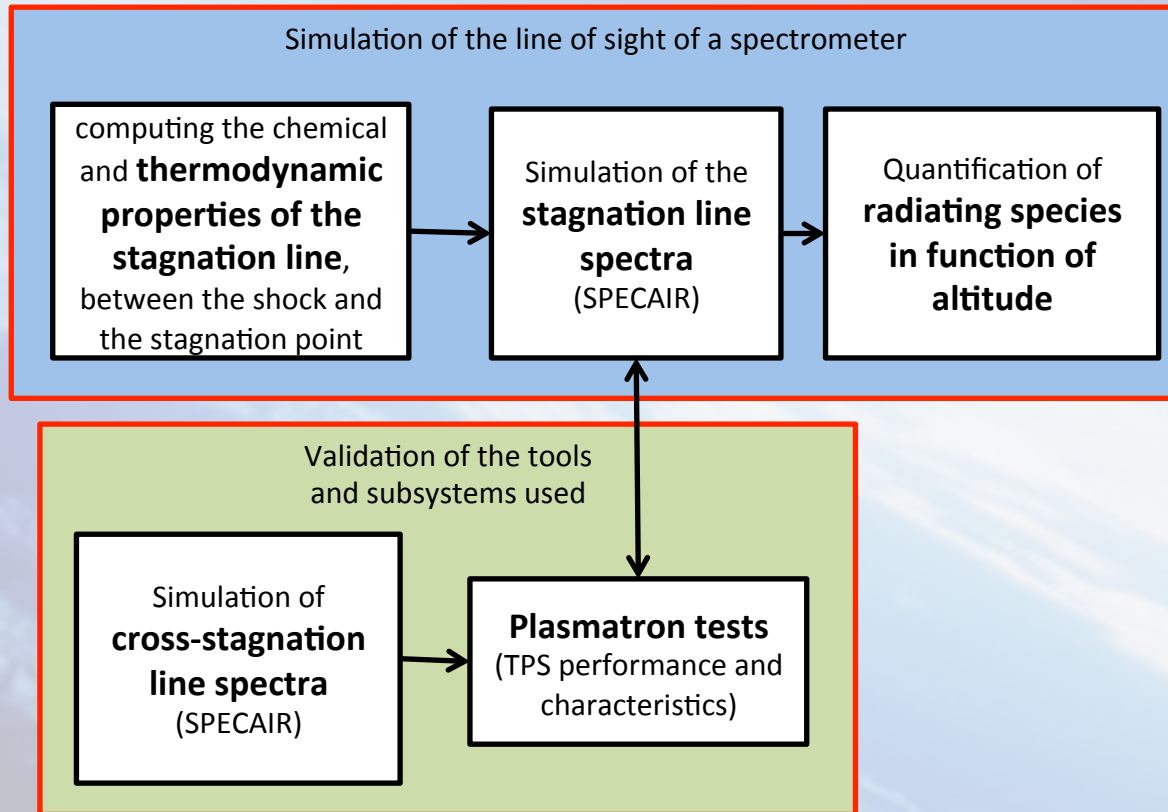

# Spectrometer Payload

-Measurement in an ablation environment-

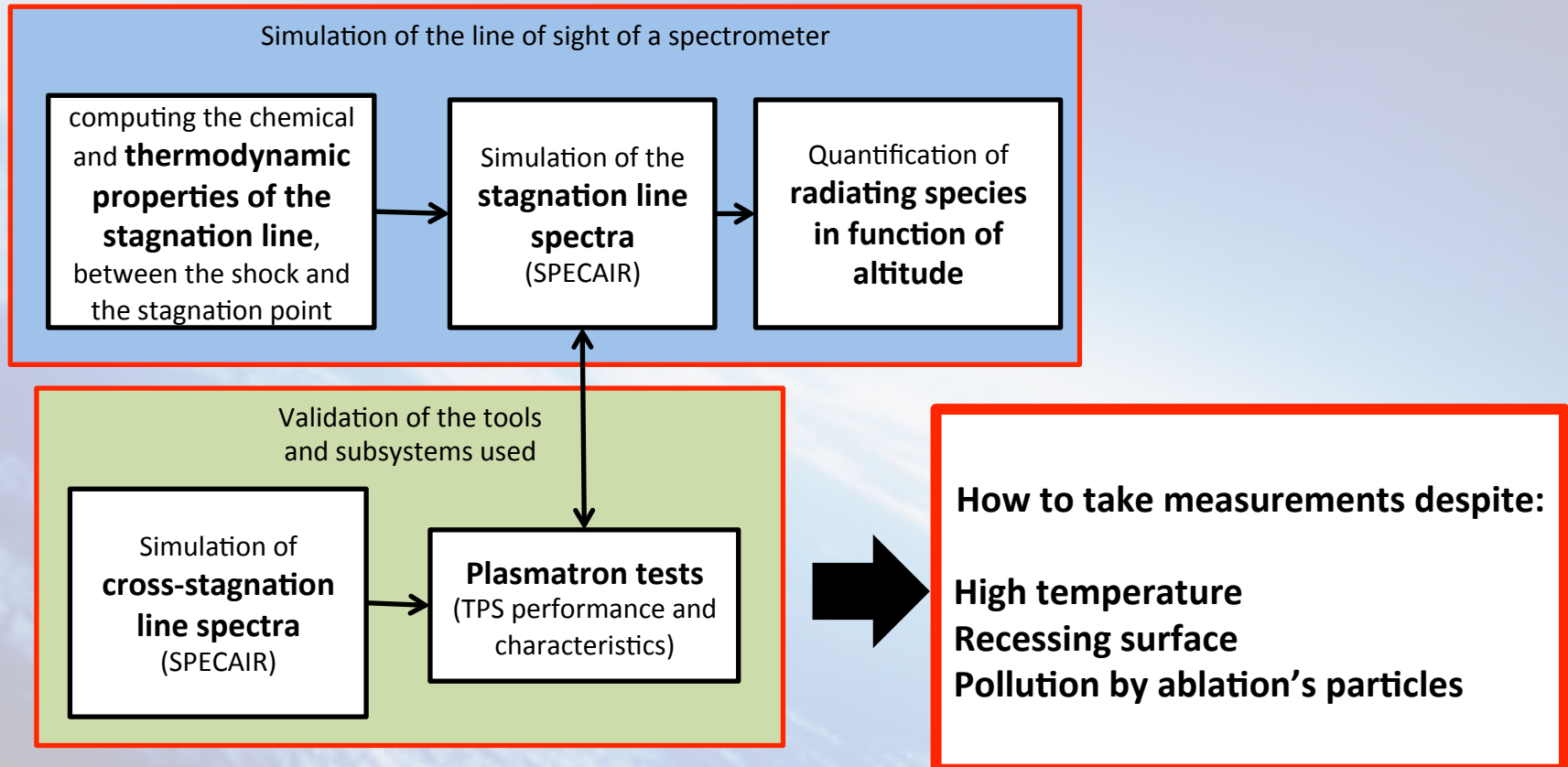

# Spectrometer Payload

-Measurement in an ablation environment-

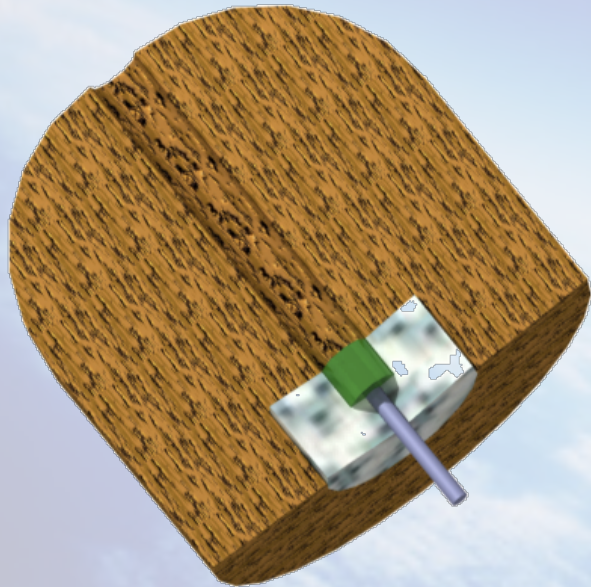

State of the art on optical path for radiation measurement on ablative TPS:

- Simple to integrate
- Mass effective
- Locally lower the heat flux with pressure oscillations in the cavity, in our case the difference is minor.

But:

- Window pollution!

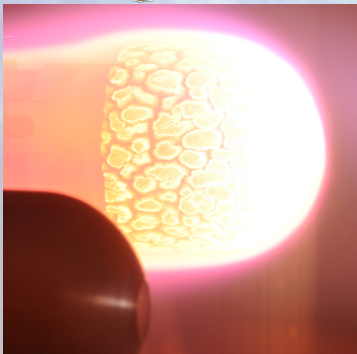

# Spectrometer Payload

-Measurement in an ablation environment-

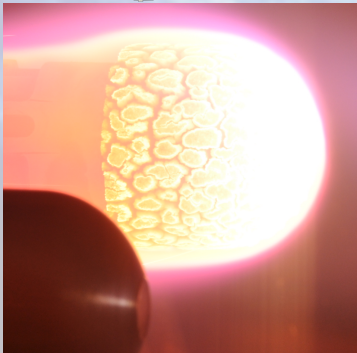
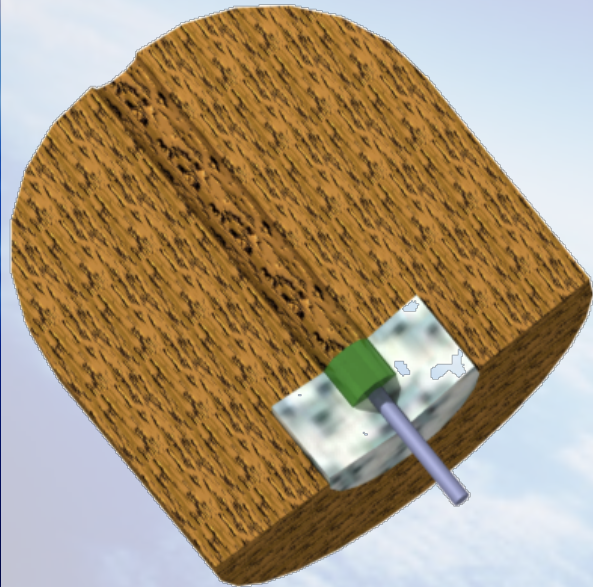

Stable  
abl

- 
- 
- 

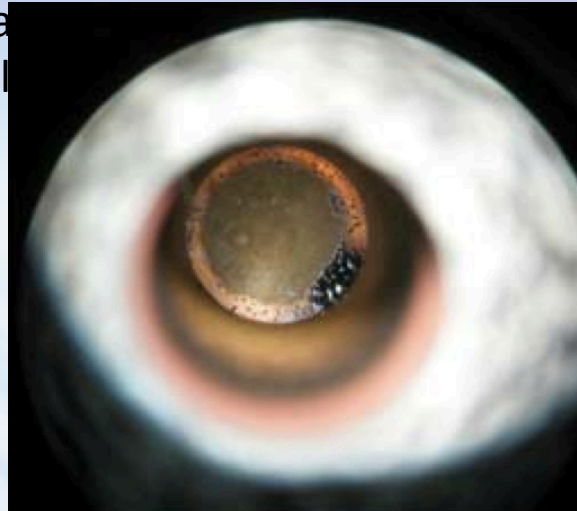

t on

the

But

Preci, et Al., **Development of a Combined Sensor System for Atmospheric Entry Missions**, 7th European Symposium on Aerothermodynamics for Space Vehicles

- Window pollution!

# Spectrometer Payload

-Measurement in an ablation environment-

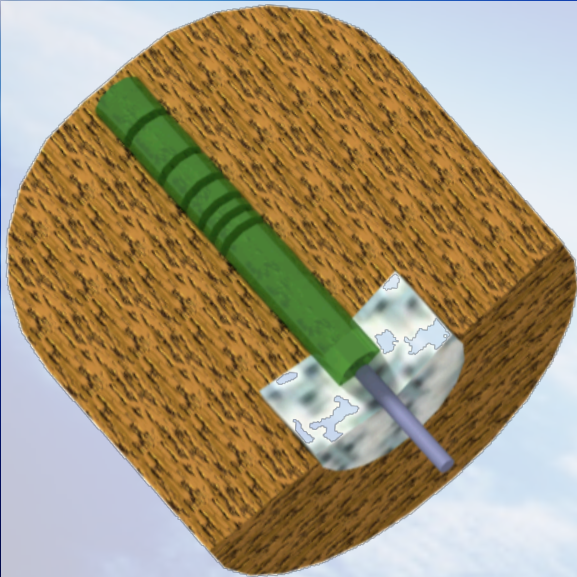

Adaptative optical path to the shape change of the ablative TPS

- Clean window at each measurement
- Easy calibration of the setup due to precise optical path state knowledge
- No complex pressure oscillation in front of the window interface

But:

- Optical path sizing dependent on the TPS and measurement points
- Complexity of the design, so more time demanding to convince

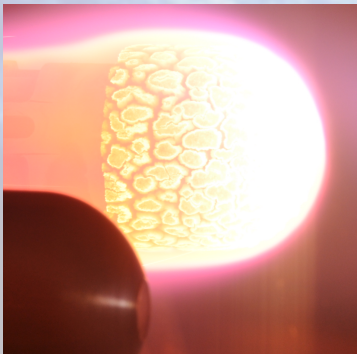



# Spectrometer Payload

-Measurement in an ablation environment-

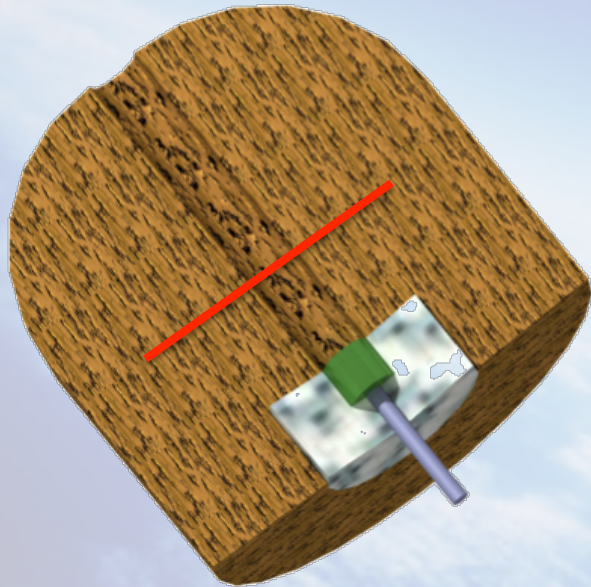

State of the art on optical path for radiation measurement on ablative TPS:

- Simple to integrate
- Mass effective
- Locally lower the heat flux with pressure oscillations in the cavity, in our case the difference is minor.

But:

- Window pollution

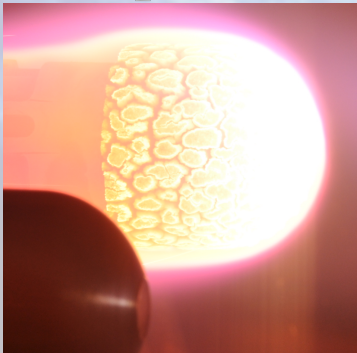

# Spectrometer Payload

-Measurement in an ablation environment-

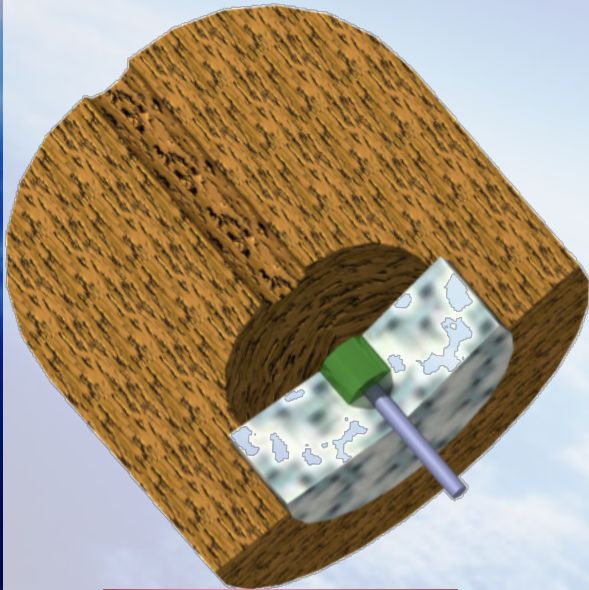

State of the art on optical path for radiation measurement on ablative TPS:

- Simple to integrate
- Mass effective
- Locally lower the heat flux with pressure oscillations in the cavity, in our case the difference is minor.

But:

- Window pollution

reduced

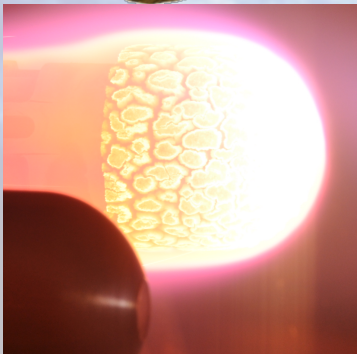

# Spectrometer Payload

-Breadboard testing-

- How to test on VKI's Mini torch (15kW) before final validation on VKI's Plasmatron (1.2 MW).



Sample support with water cooling system and probing access

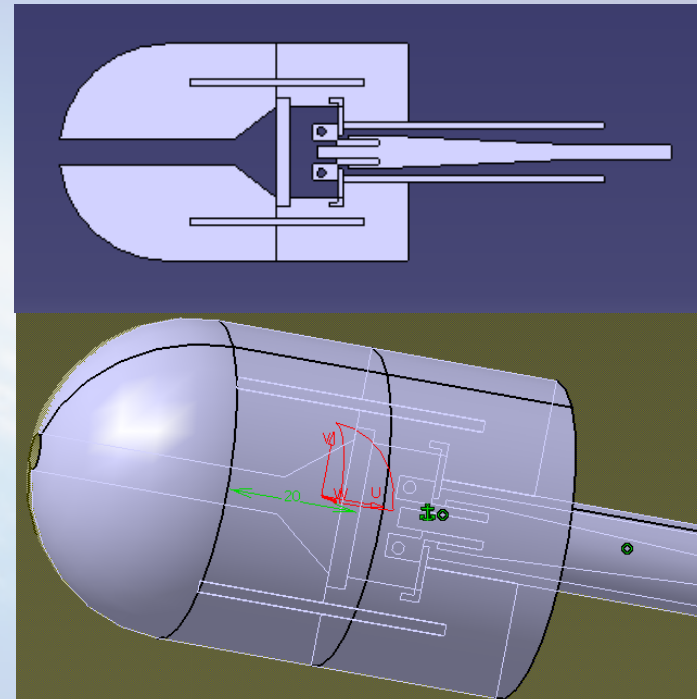

Sample instrumentation and the coupling system

# Spectrometer Payload

-Breadboard testing-

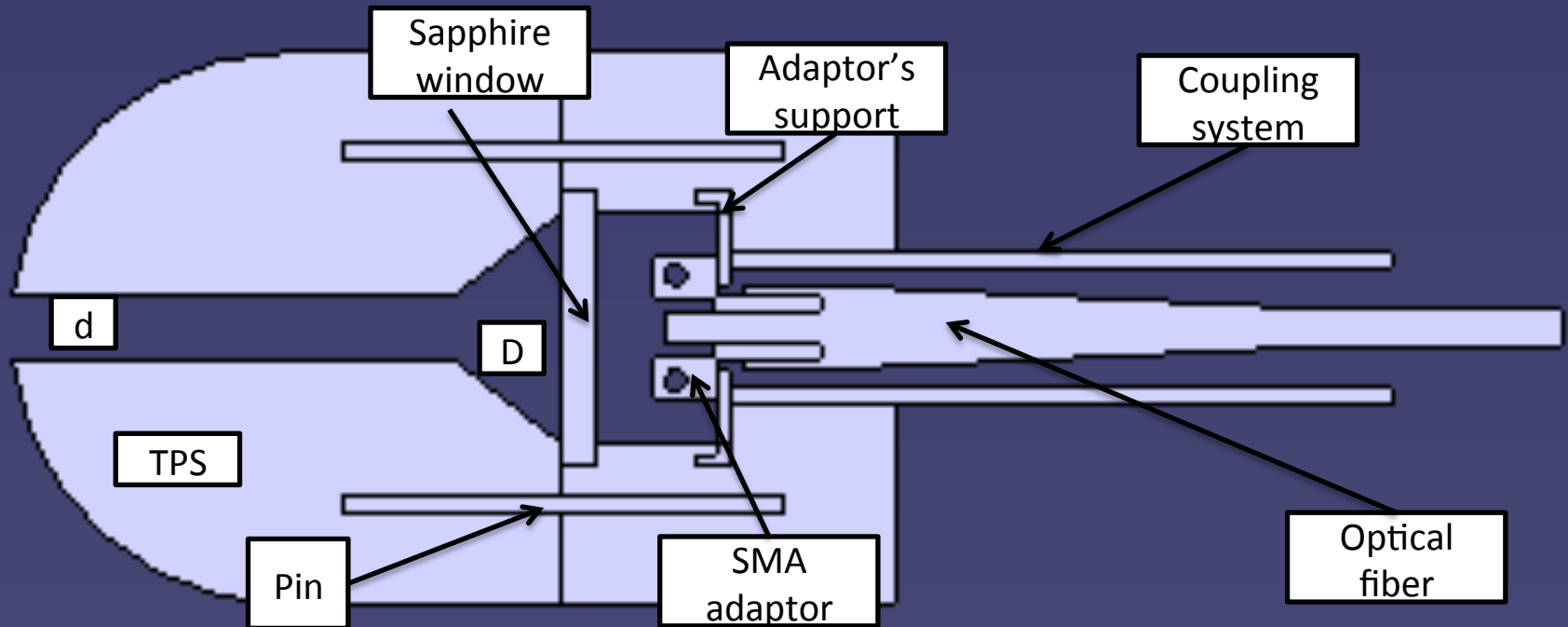

Sample instrumentation and the coupling system

# Spectrometer Payload

-Breadboard testing-

- Testing in mini-torch for debugging and final tests in plasmatron

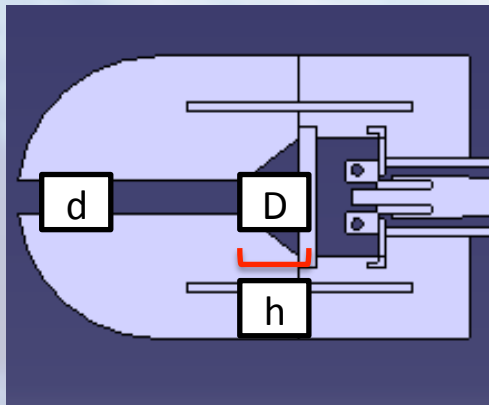

## Minitorch Test campaign Effectiveness time (ET)

- Test1:  $d=6\text{mm}; D=6\text{mm}; h=0\text{mm}$  LP ET=130s
- Test2:  $d=4\text{mm}; D=4\text{mm}; h=0\text{mm}$  ET=325s
- Test3:  $d=2\text{mm}; D=2\text{mm}; h=0\text{mm}$  ET=383s
- Test4:  $d=4\text{mm}; D=20\text{mm}; h=10\text{mm}$  ET=525s (No Extinction)
- Test5:  $d=2\text{mm}; D=20\text{mm}; h=10\text{mm}$  ET=405s (No Extinction)
- Test7:  $d=4\text{mm}; D=20\text{mm}; h=5\text{mm}$  ET=496s (No Extinction)
- Test8:  $d=4\text{mm}; D=10\text{mm}; h=10\text{mm}$  ET=440s (No Extinction)

# Spectrometer Payload

-Breadboard testing-

- Testing in mini-torch for debugging and final tests in plasmatron

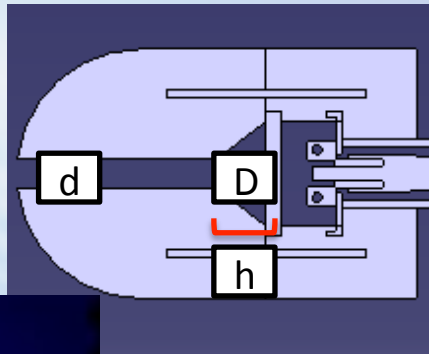

**Test campaign** Effectiveness time (ET)  
Based on:  $d=4\text{mm}$ ;  $D=20\text{mm}$ ;  $h=10\text{mm}$   
At HIGH HEATFLUX ( $1.5\text{MW}/\text{m}^2$  at 100mbar)

- Test6: ET=170s
- Test9: Conical ET=190s
- Test10: Conical with Eccoband 285 coating ET=185s
- Test11: With Kapton tape coating ET=245s

**Heat load Test11 ( $368\text{ MJ}/\text{m}^2$ )**

**>>> Heat load QARMAN ( $450\text{ kJ}/\text{m}^2$ )**

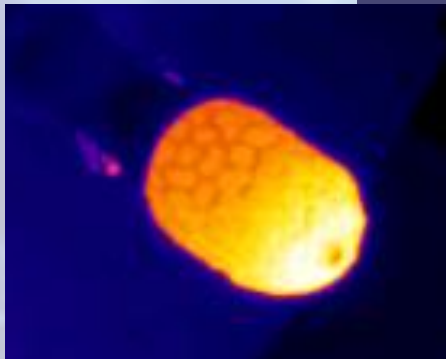

# Spectrometer Payload

-Breadboard testing-

- Temperatures within the cavities (Survivability test)

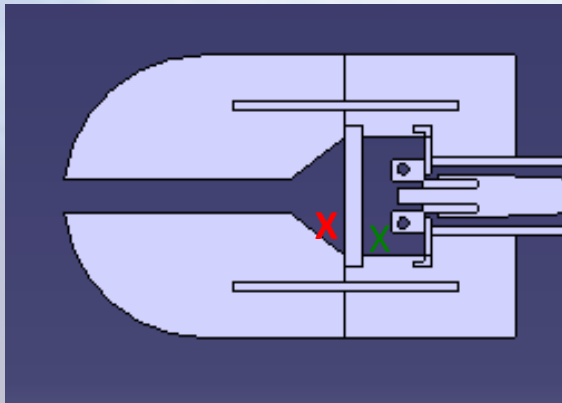

X Nominal test row

X Additional tests

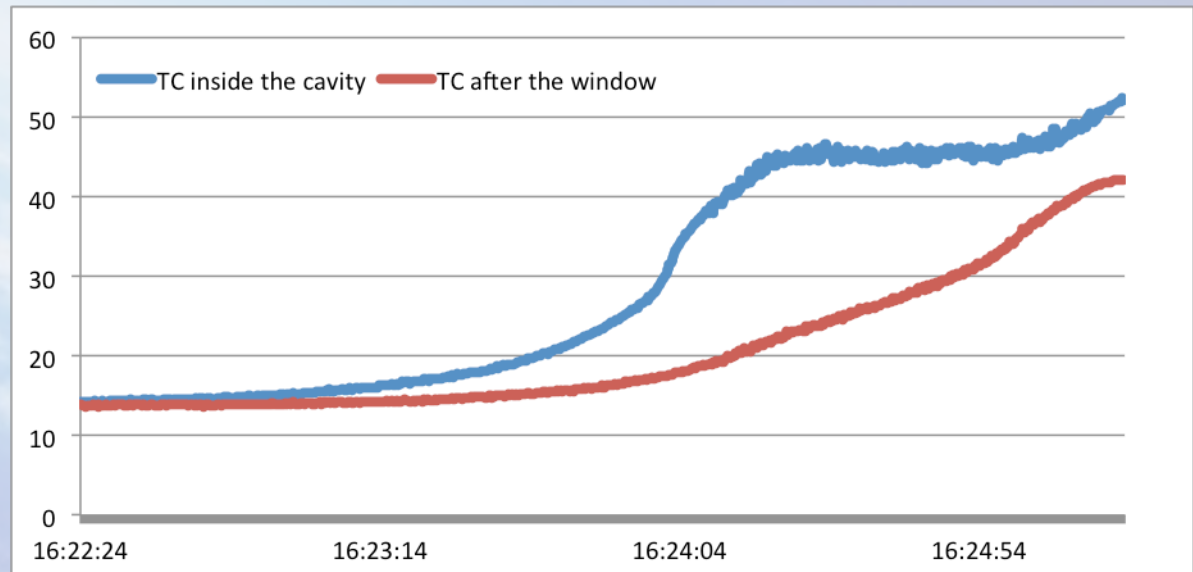

# Spectrometer Payload

-Integration methodology-

Dimensions:  
81.2x40x32.8  
mm<sup>3</sup>

Integrated view of the Imbedded Nano-size Emission Spectrometer  
within the QARMAN's platform



# Spectrometer Payload

-Integration methodology-

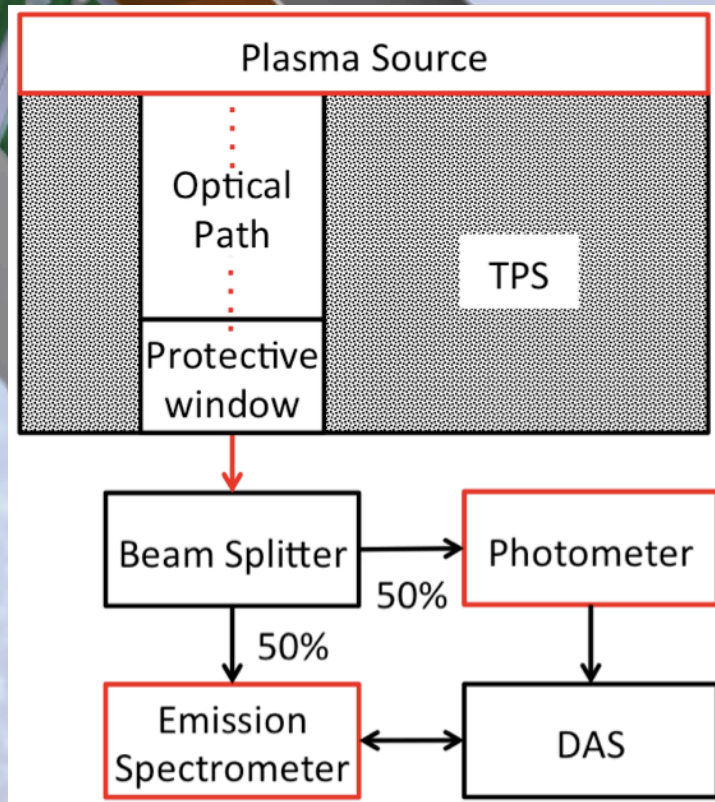

Dimensions:  
81.2x40x32.8  
mm<sup>3</sup>

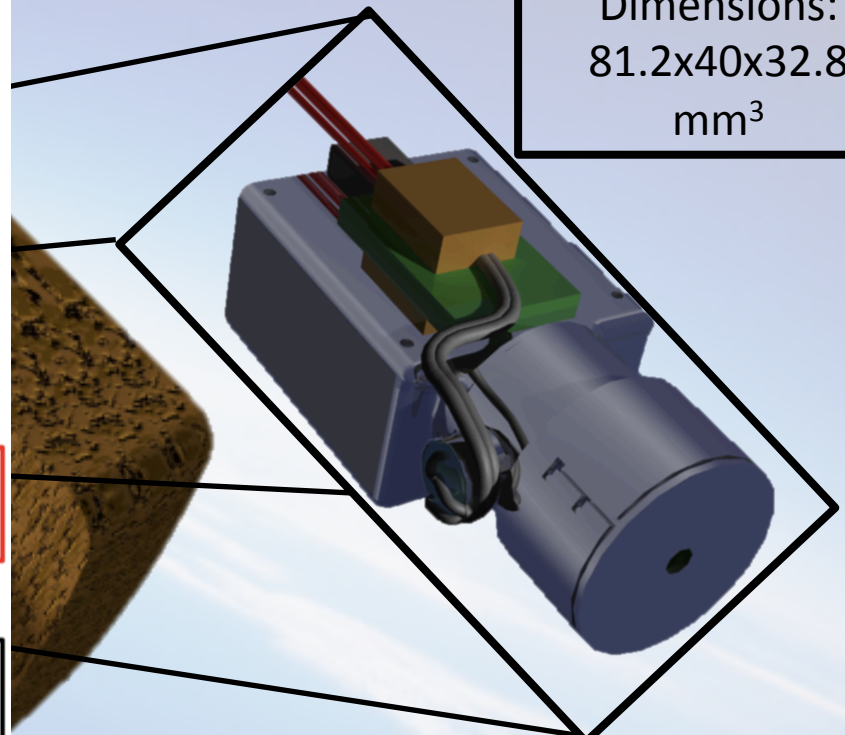

Integrated view of the Imbedded Nano-size Emission Spectrometer within the QARMAN's platform

# Spectrometer Payload

-Breadboard testing-

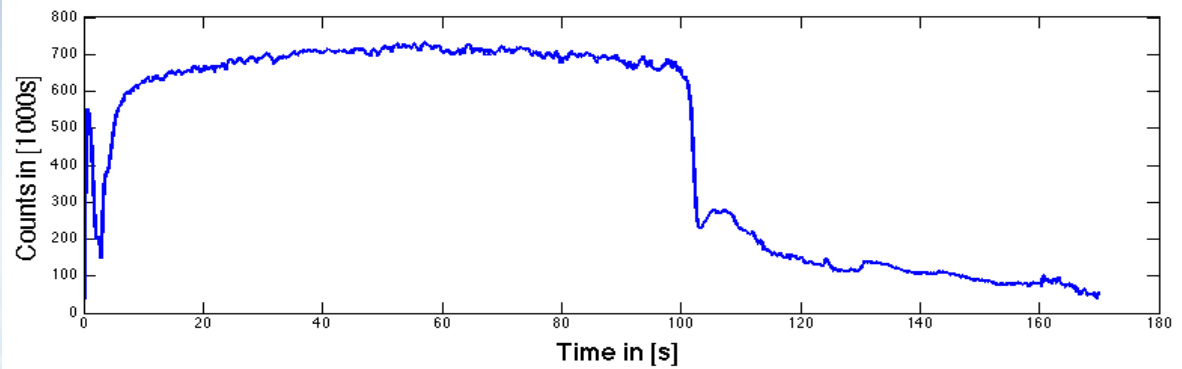
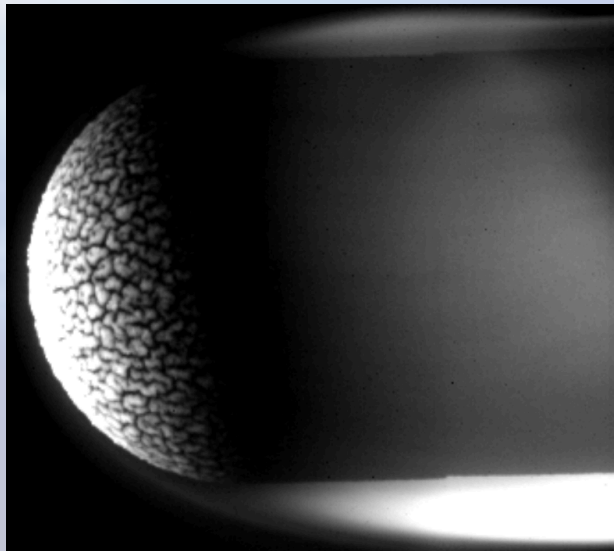

Imbedded spectrometer result

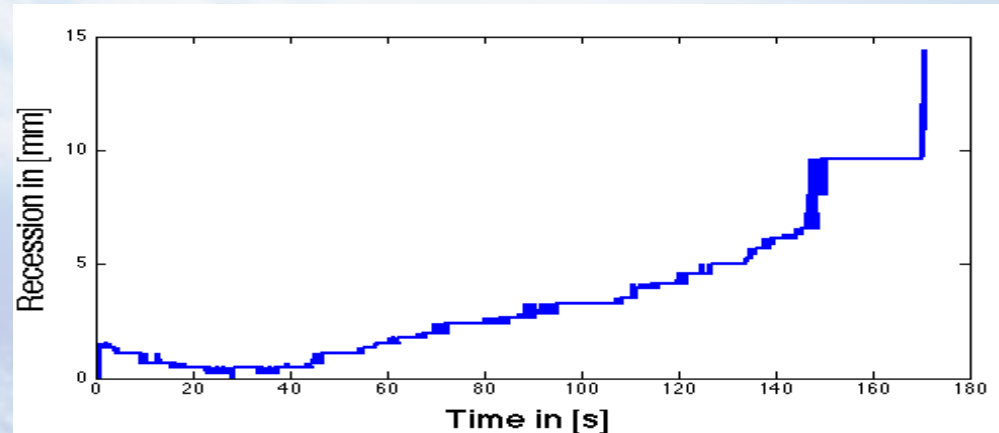

## Test conditions:

HeatFlux: 1+MW/m<sup>2</sup>

Pressure: 100 mbar

Quartz tube  
inner diameter: 300 mm

# Spectrometer Payload

-Breadboard testing-

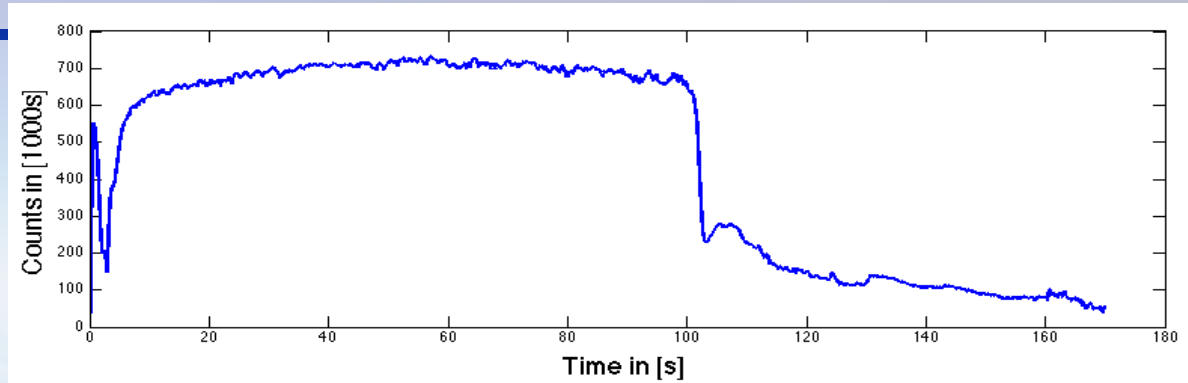
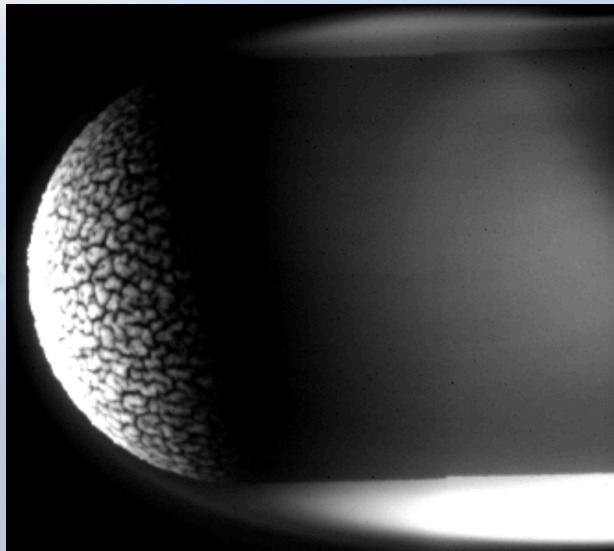

Imbedded spectrometer result

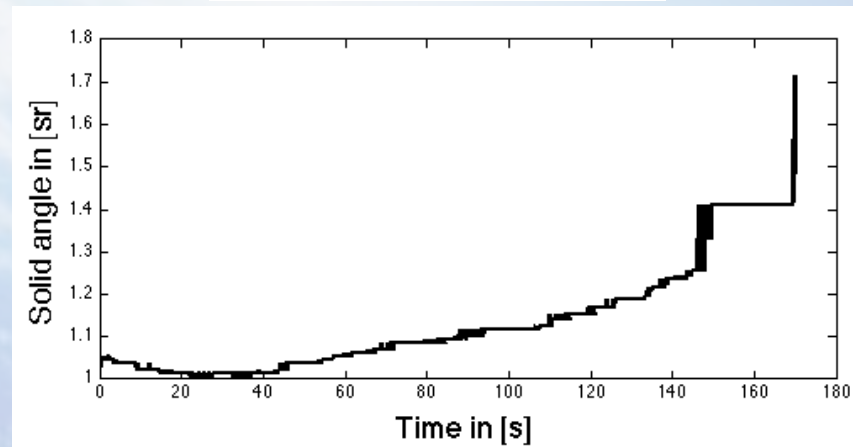

Solid angle of view of the spectrometer

## Test conditions:

HeatFlux: 1+MW/m<sup>2</sup>  
HeatLoad: 170MJ/m<sup>2</sup>

Pressure: 100 mbar

Quartz tube  
inner diameter: 300 mm

# Spectrometer Payload

-Measurement chain-

## Tests done with HR4000 spectrometer

Capability to select: Int. time, start pixel and interval

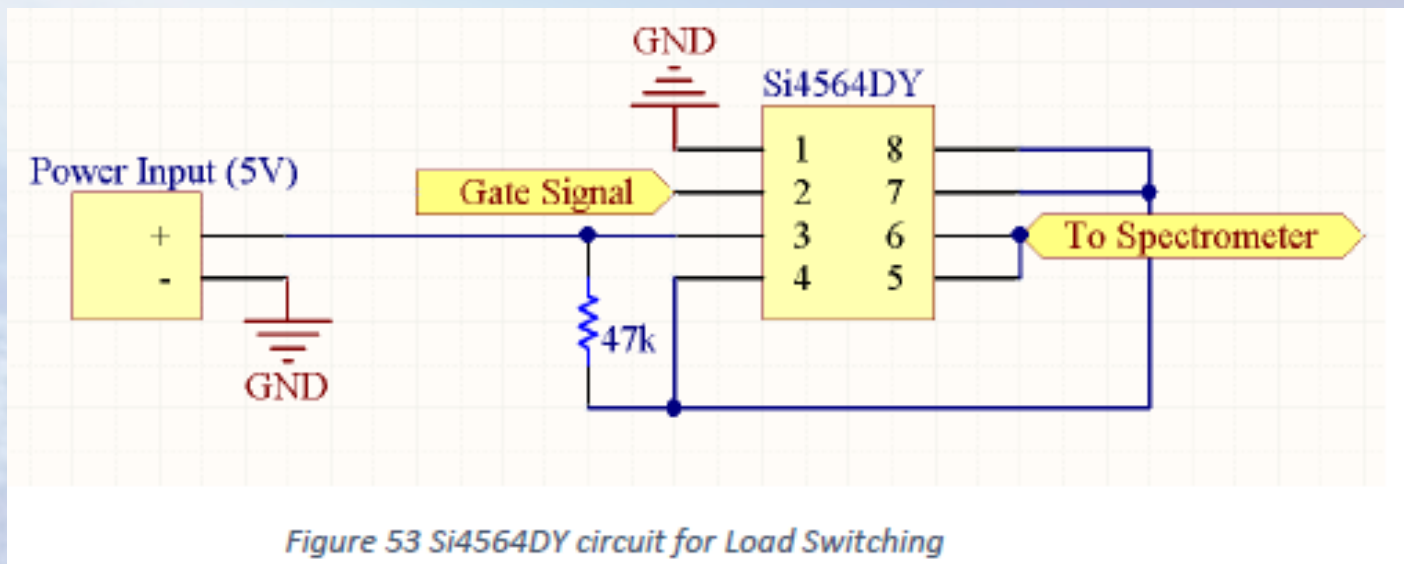

Thanks to Eray Akyol and Deniz Aksulu

# Spectrometer Payload

-Measurement chain-

## Photodiode Circuitry for Spectrometer Triggering

Deuterium

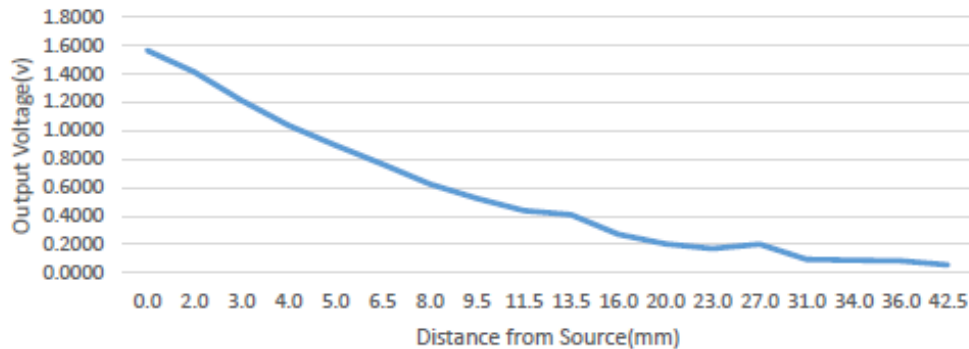

Halogen

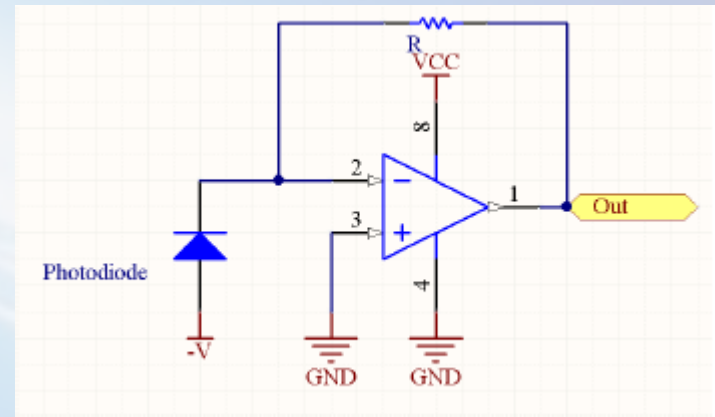
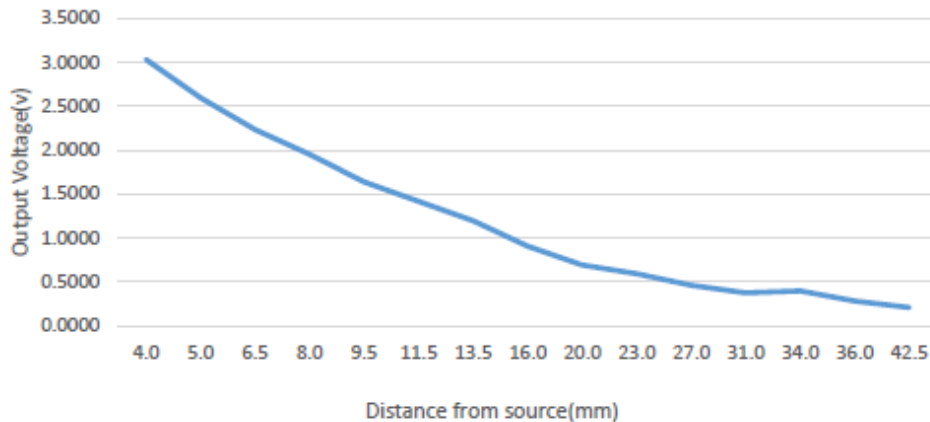

Thanks to Eray Akyol and Deniz Aksulu

# Conclusion

- Proposed design for the imbedded emission spectrometer
  - Full scale test (before end of June 2014)
- Based on the preliminary investigations (**decoupled approach**) the spectrometer payload will provide important flight data
  - Conduct the analysis over the full trajectory and classifying the observed phenomenon by wavelength categories (by the end of March)
  - Conduct a sensitivity analysis to predict the range of scientific return (in the coming months)

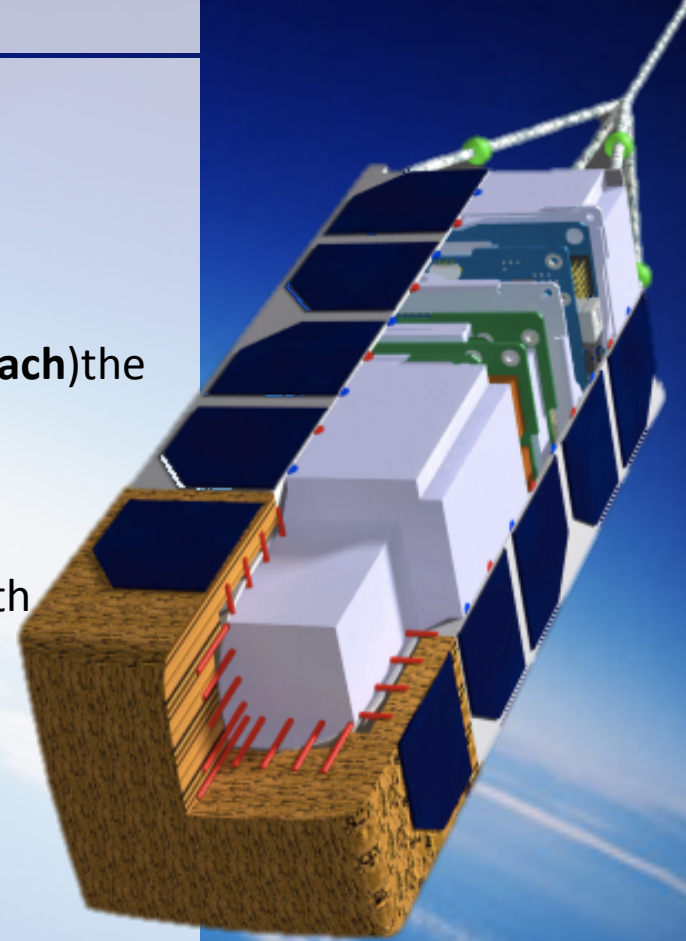

# Future work

- Additional decoupled study
  - Use of pyrolysis gas injection into the stagnation line  
(In the coming months thanks to Alessandro Turchi)
  - Comparing different models for both stagnation line code and radiation code (In the coming months)
- Coupled study (2015)
- Validating the measurement technique at VKI's and ECP's plasma torches (Partially done)

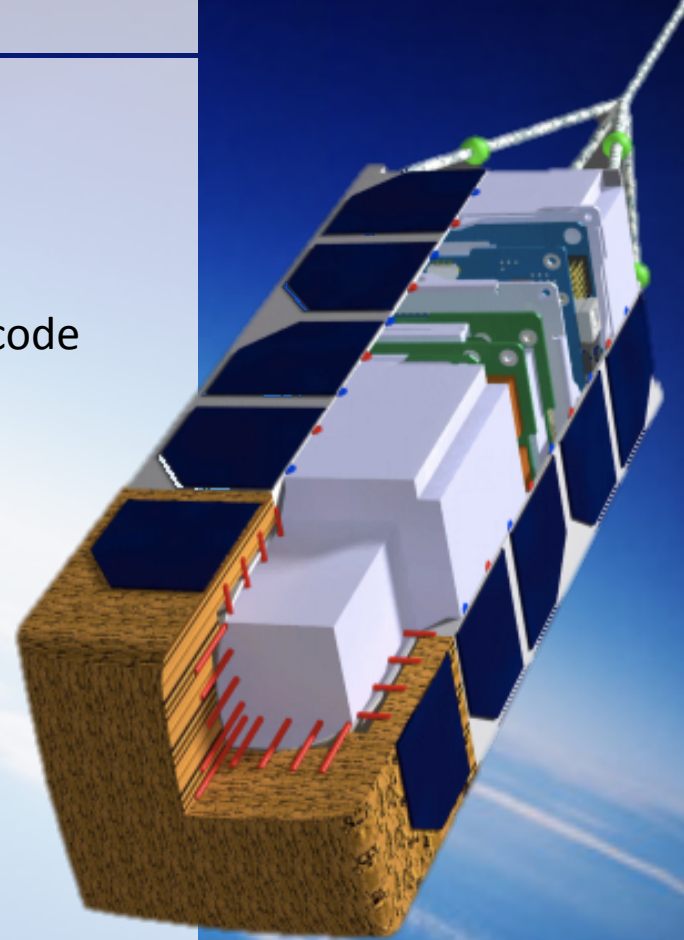

# Acknowledgement



The research leading to these results has received funding and support from AIRBUS defence & space through the ANRT's CIFRE program

Special thanks to Mr. Alexis Bourgoing, Franck Delattre, Jean-Marc Bouilly, Marc Dormieux and Coumar Oudea

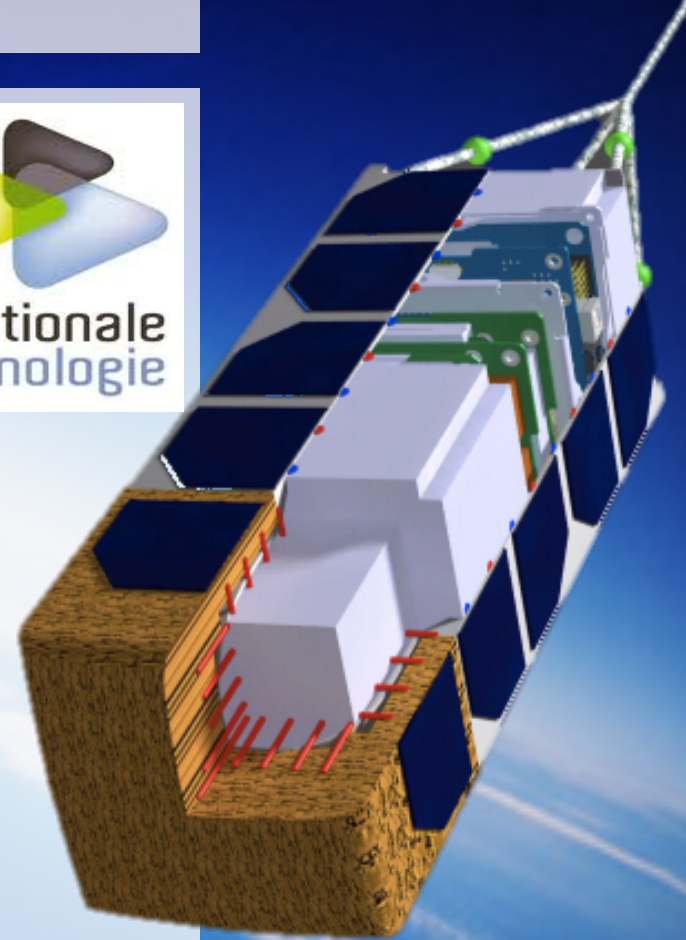





Thank you  
for your attention

-bailet@vki.ac.be-

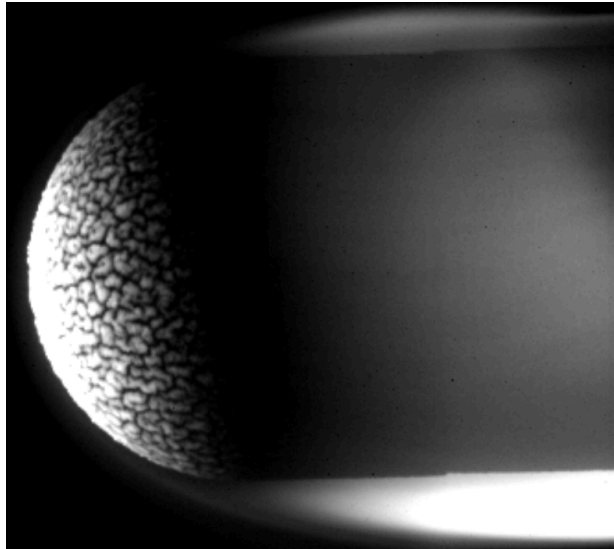

**Test conditions:**

HeatFlux: 1+MW/m<sup>2</sup>

HeatLoad: 170MJ/m<sup>2</sup>

Pressure: 100 mbar

Quartz tube

inner diameter: 300 mm

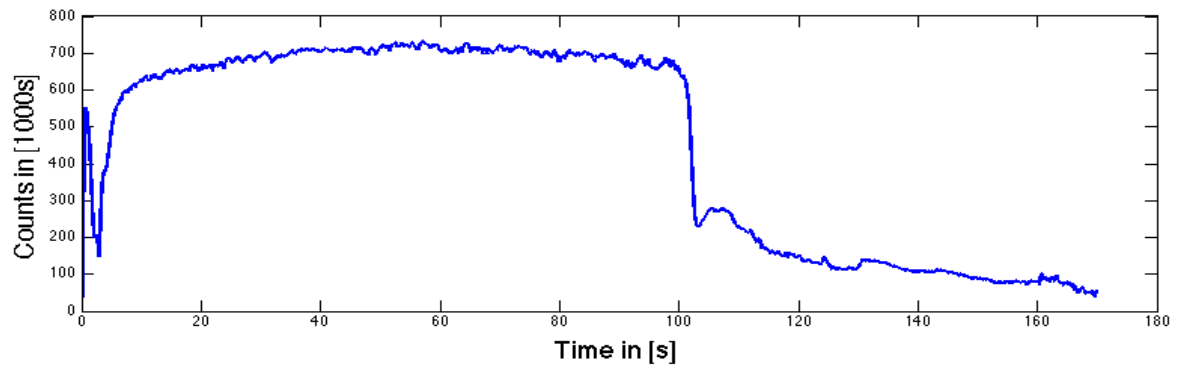

Imbedded spectrometer result

# Breadboard testing

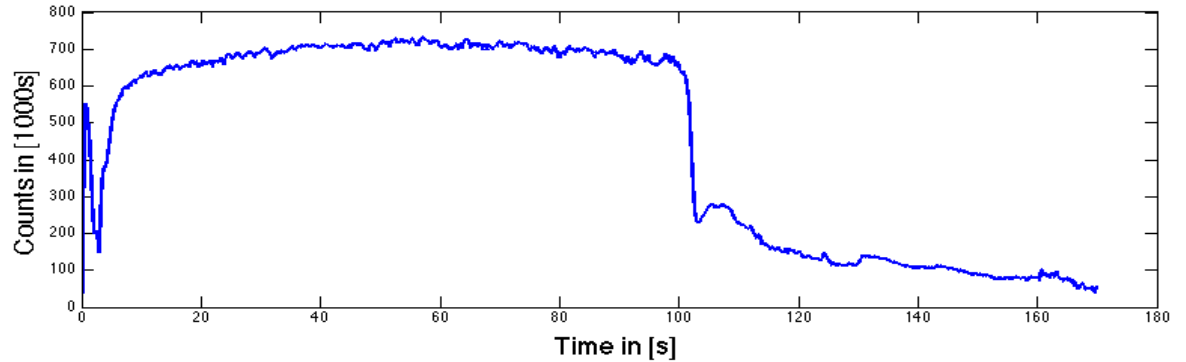
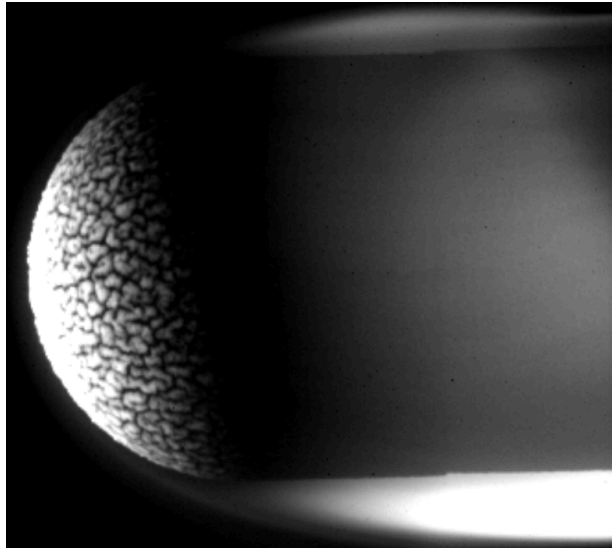

Imbedded spectrometer result

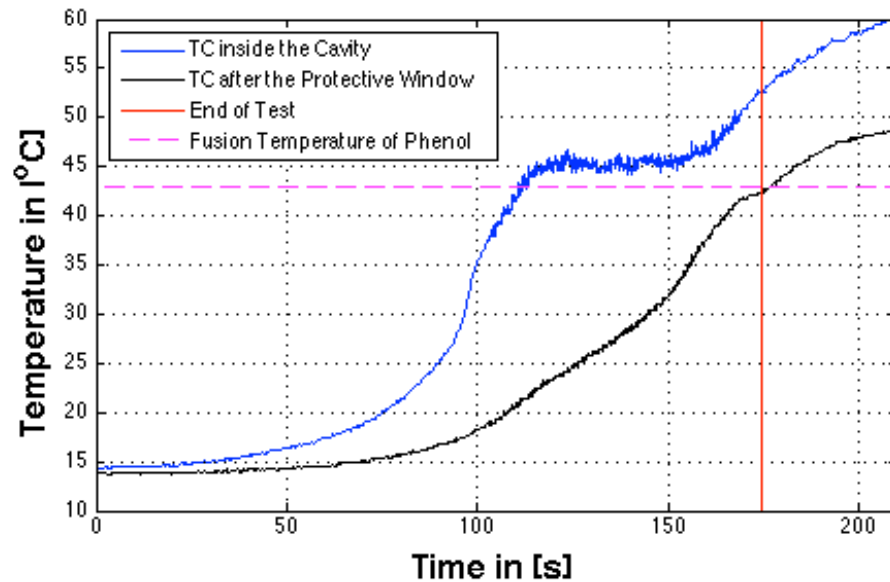

**Test conditions:**

HeatFlux: 1+MW/m<sup>2</sup>  
 HeatLoad: 170MJ/m<sup>2</sup>  
 Pressure: 100 mbar  
 Quartz tube  
 inner diameter: 300 mm

# Spectrometer Payload

-Breadboard testing-

Test 1: Safety test

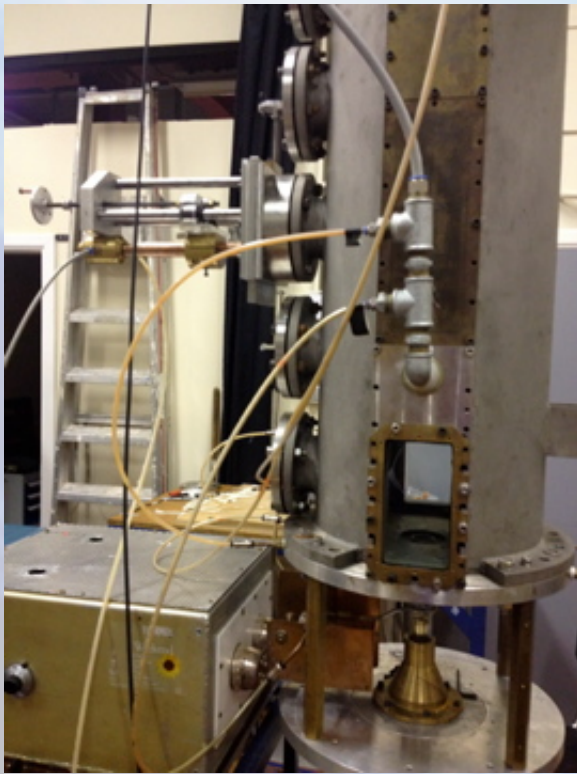

## Test conditions:

Power: 50% (7.5 kW)

Mass flow: Air at 0.6 g/s

Pressure: 10 mbar

Quartz tube  
inner diameter: 30 mm

# Spectrometer Payload

-Breadboard testing-

Test 1: Safety test

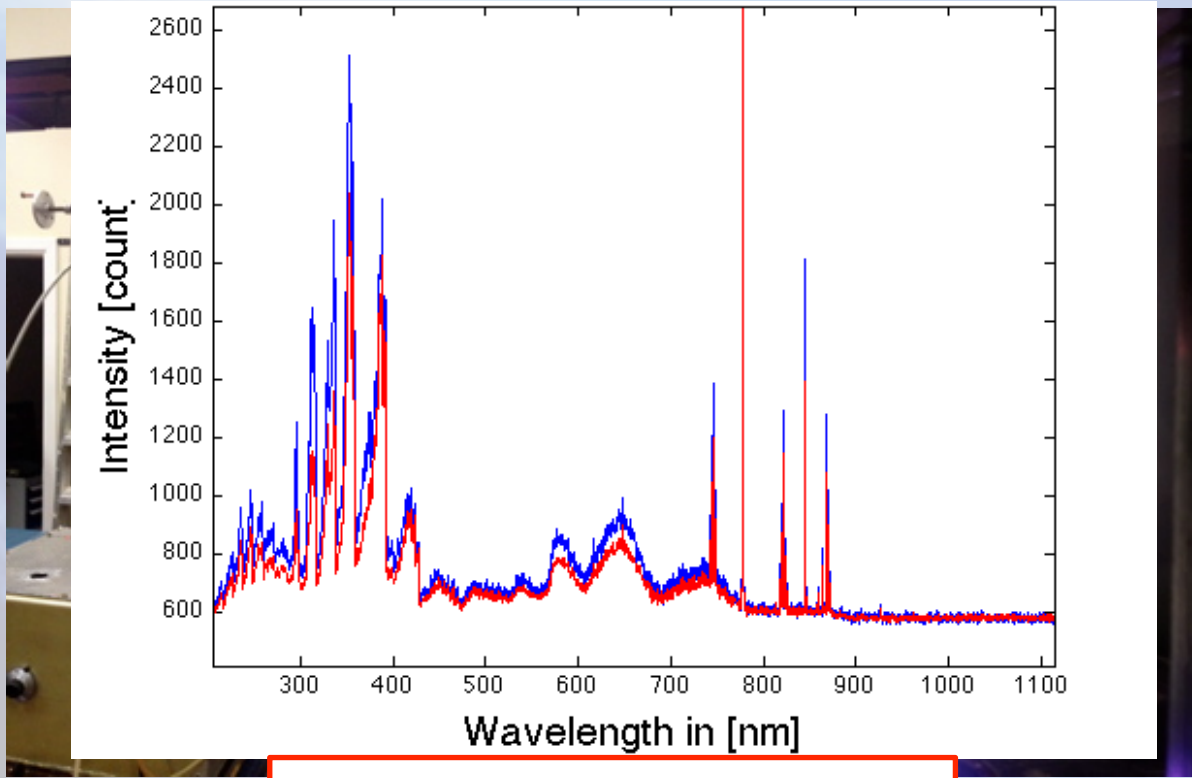

Effect of window pollution over 80 seconds

### Test conditions:

Power: 50% (7.5 kW)

Mass flow: Air at 0.6 g/s

Pressure: 10 mbar

Quartz tube  
inner diameter: 30 mm

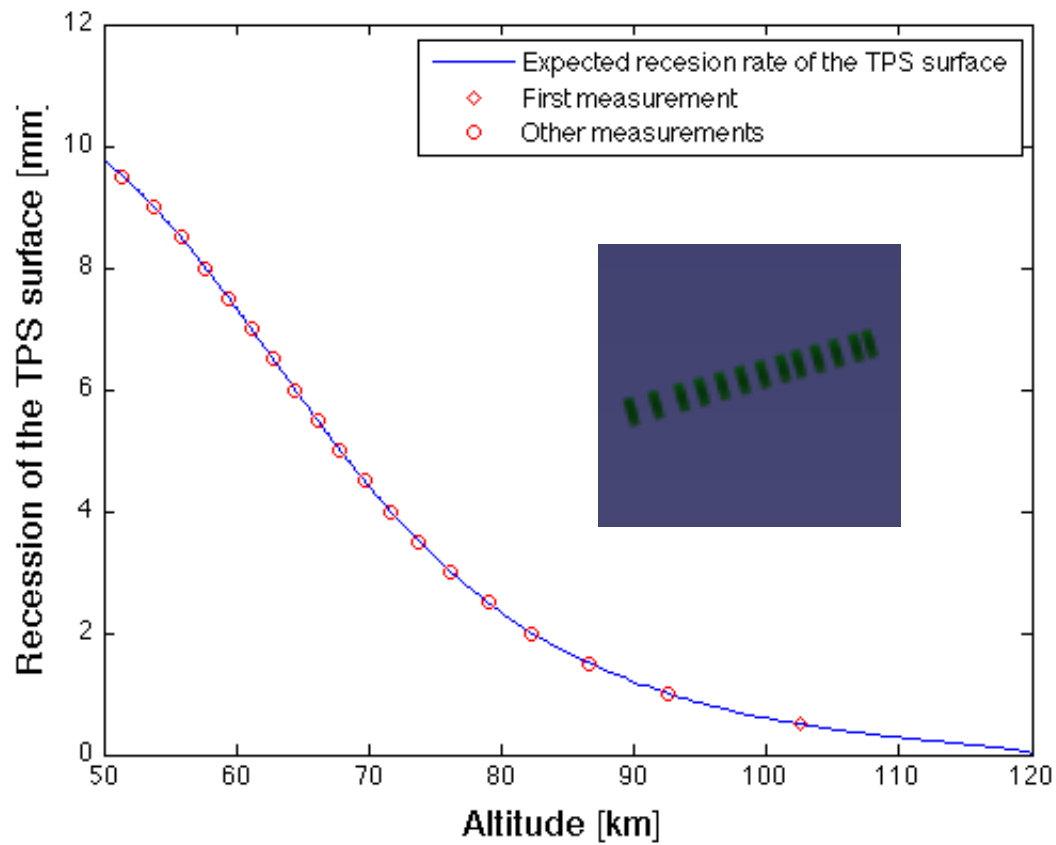

— Expected recession rate of the TPS surface

(a) at injection ( $t = 0.5\text{s}$ )

(b) end of test ( $t = 100\text{s}$ )

(c) detail of (a)

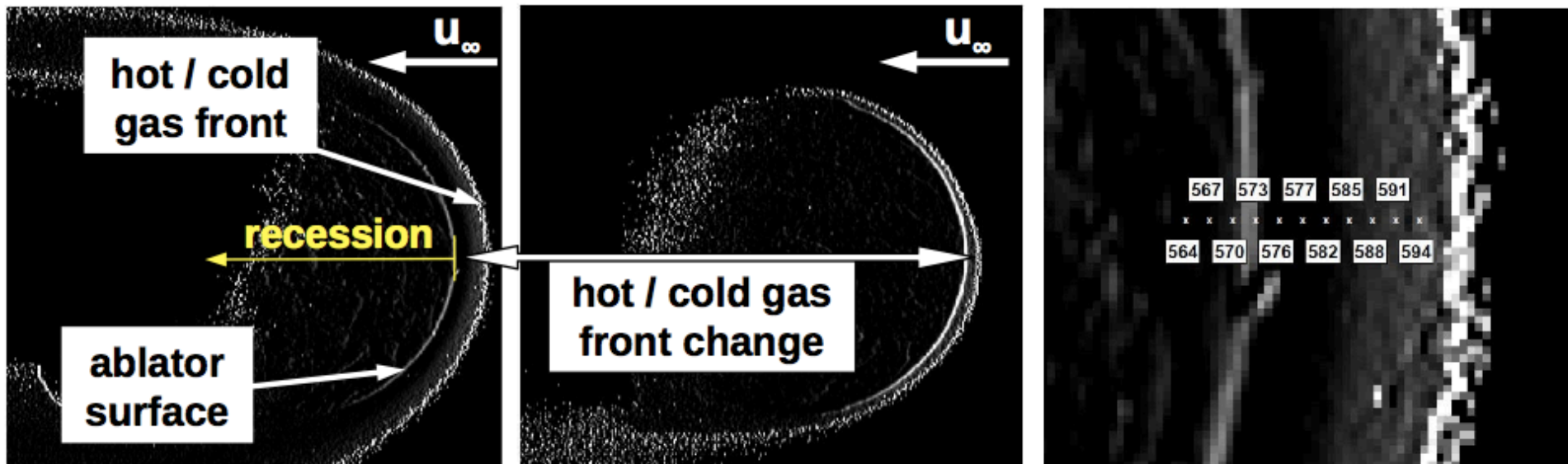

Calculus of the TPS recession by means of an high speed camera  
Credit: Bernd Helber

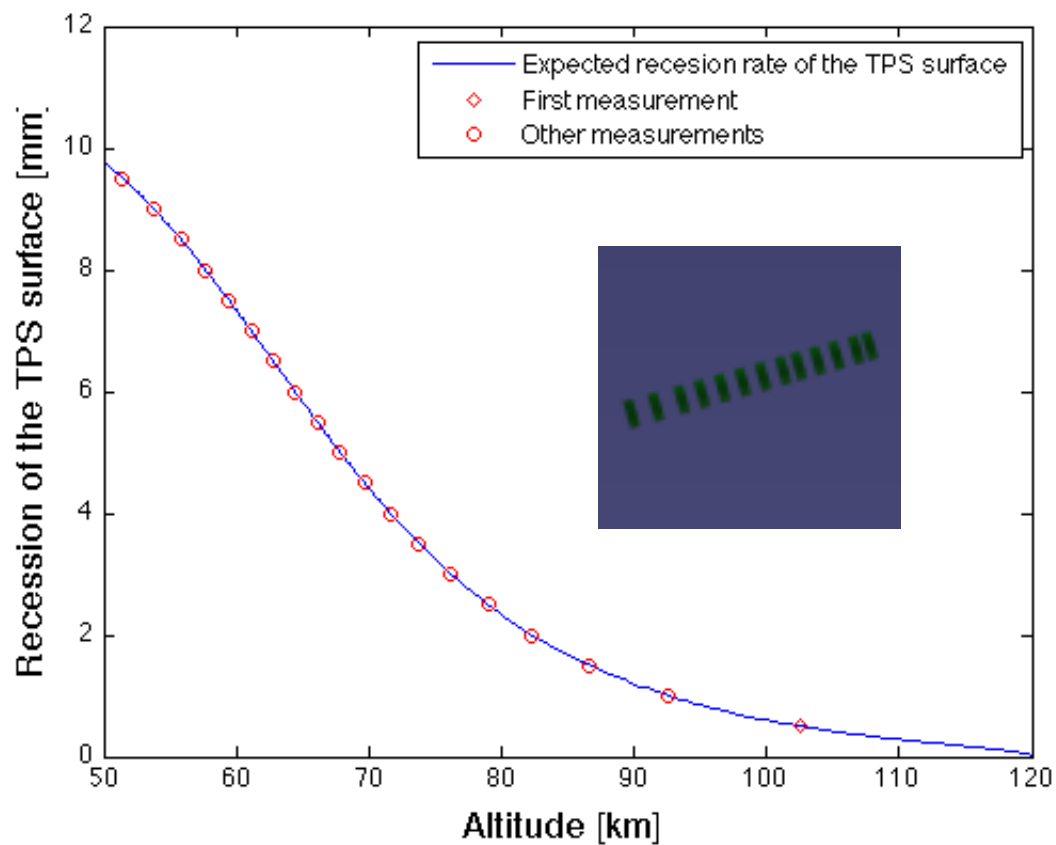



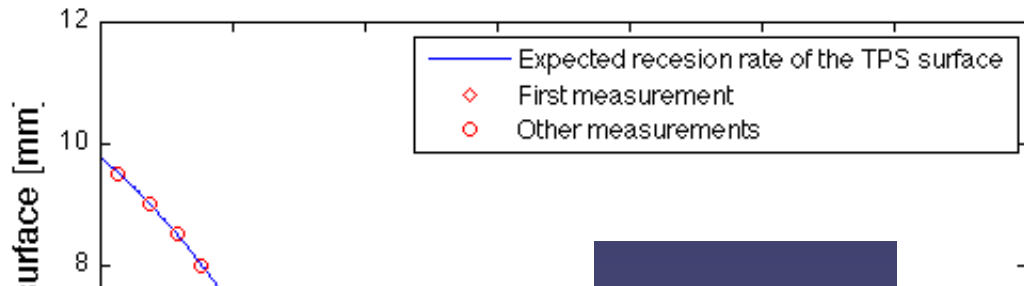

Future update of the design with a new  
 EADS Astrium's light ablator  
 ASTERM or AQ 61 which have higher performances

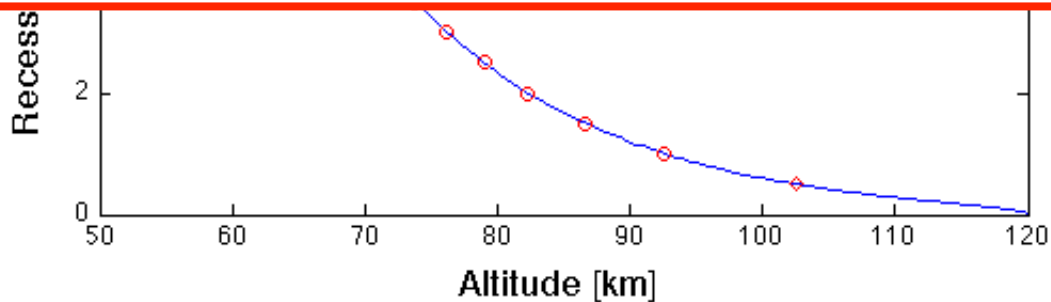

Translation aux noeuds

mm

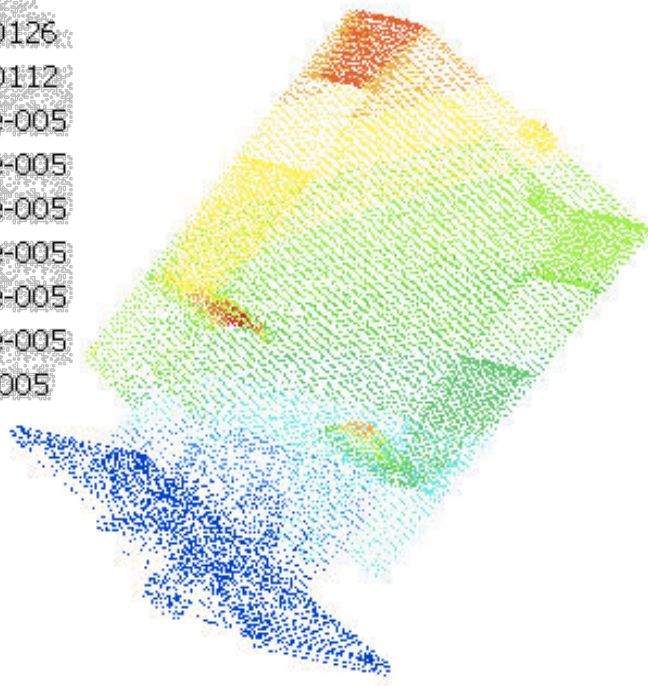
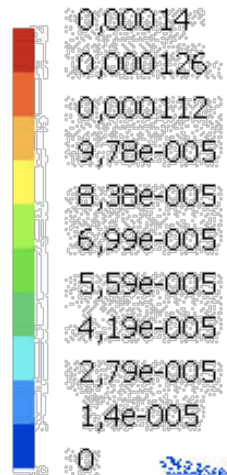

Critère de Von Mises

N\_m2

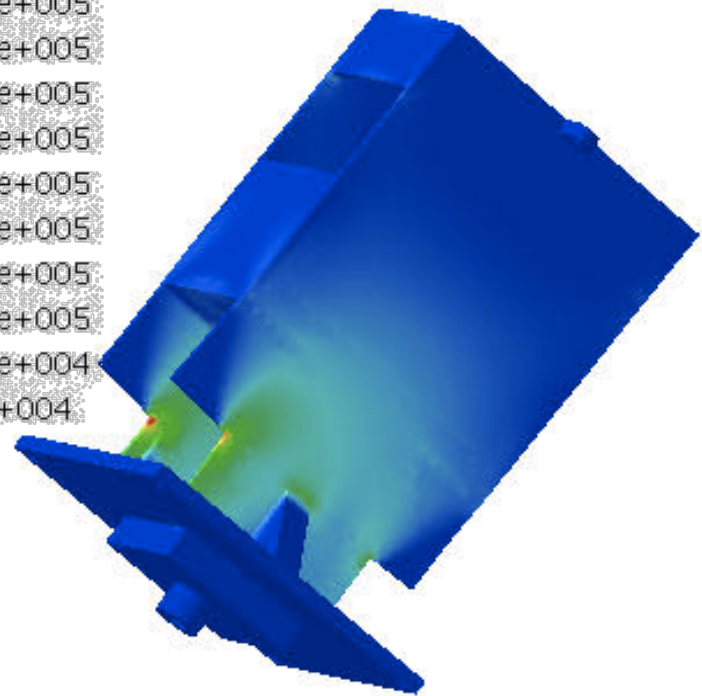
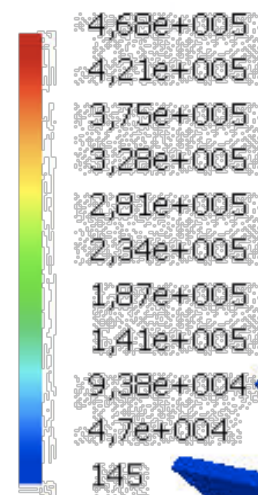

# QARMAN Platform

-Heat flux profile-

## Monte Carlo simulation taking in account the different uncertainties

- Atmospheric parameters
- Aerodynamic coefficients
- Initial conditions

A scattering of  $\pm 10\%$  on the nominal value.

Trajectory code and heat flux (Detra, Kemp and Riddell approximation) implementation validated with the literature

Reference: A. Schettino, et al., "Aerodynamic and Aerothermodynamic Data Base of Expert Capsule"

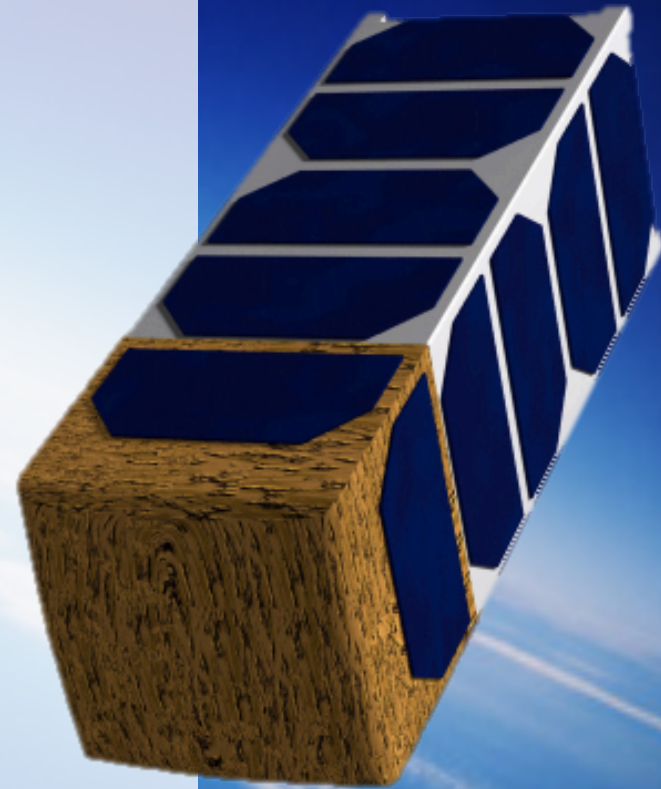

# Spectrometer Payload

-Design methodology-

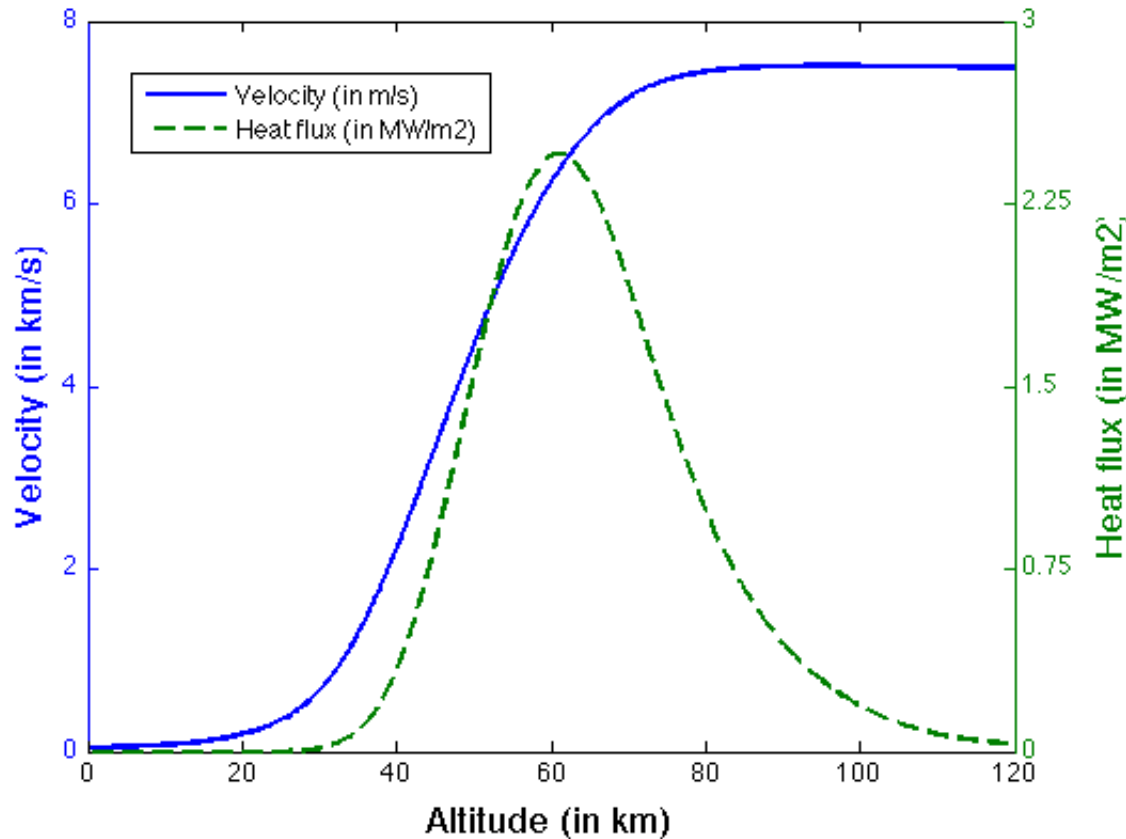

## Maximal heat flux point conditions:

Altitude: 61.251km  
Velocity: 6421.4 m/s  
Free stream pressure: 19.7184 Pa  
Free stream temperature: 239.3856 K

# QARMAN Platform

-Heat flux profile-

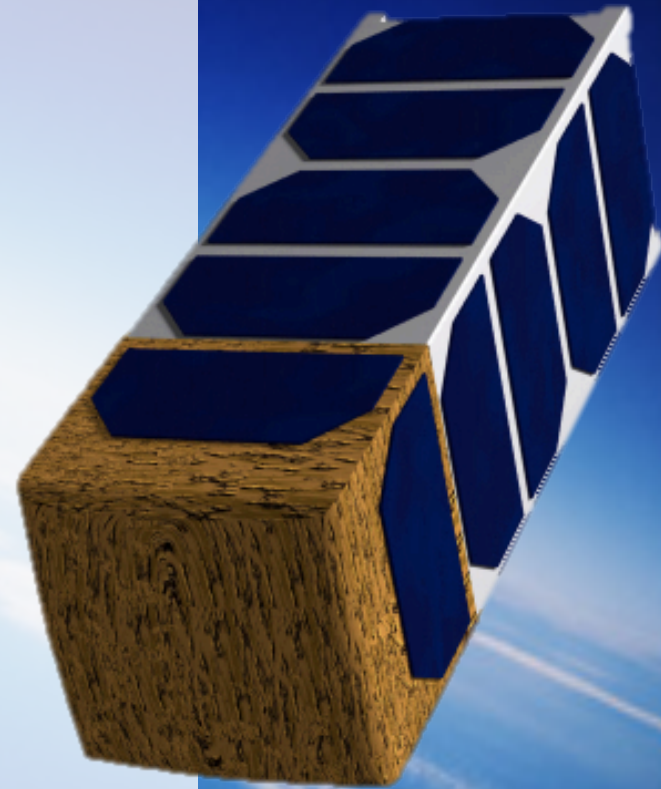
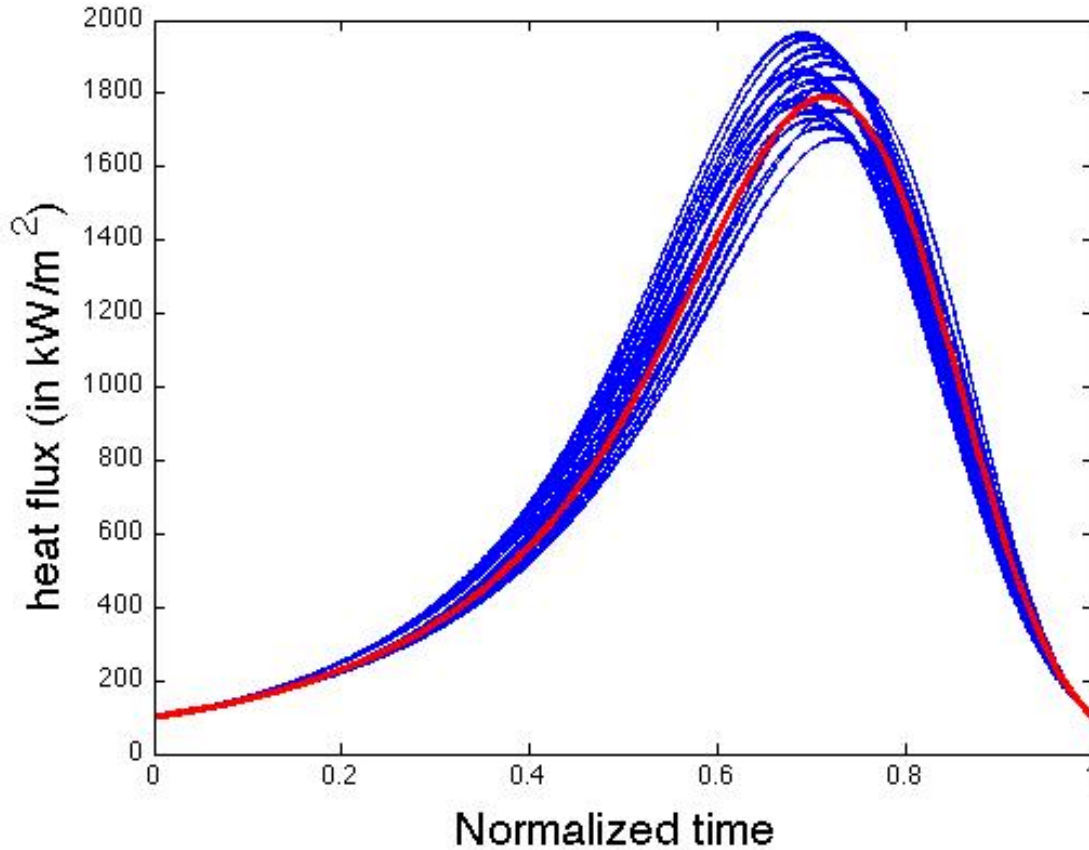

# QARMAN Platform

-Thermal Protection System sizing-

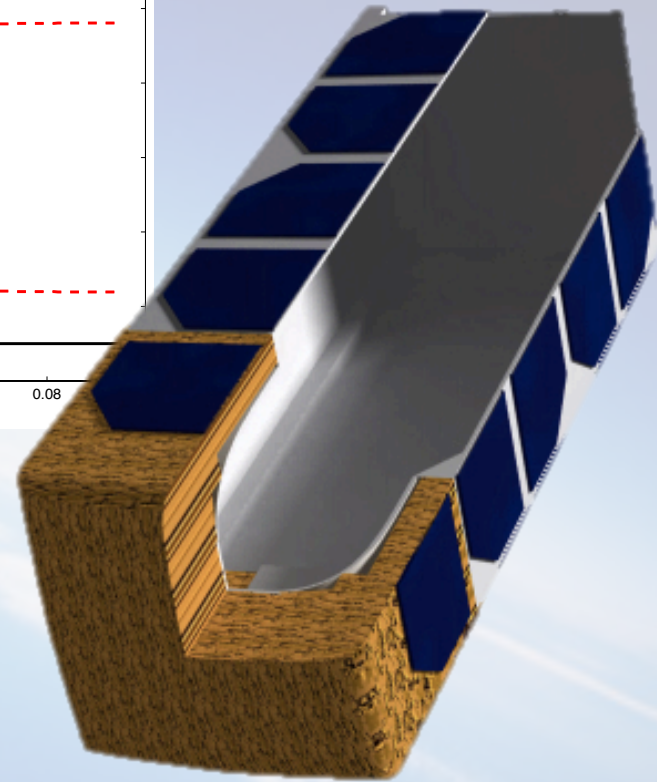
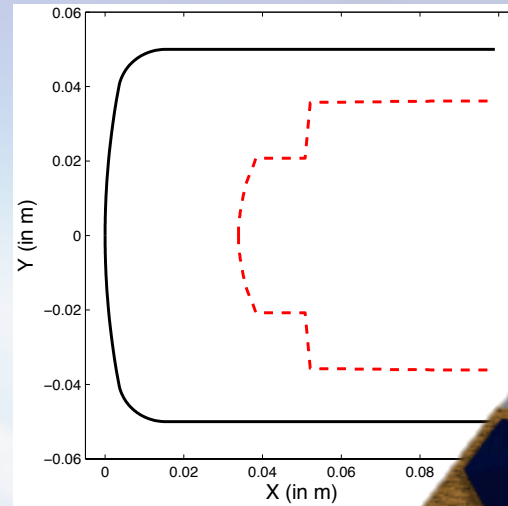
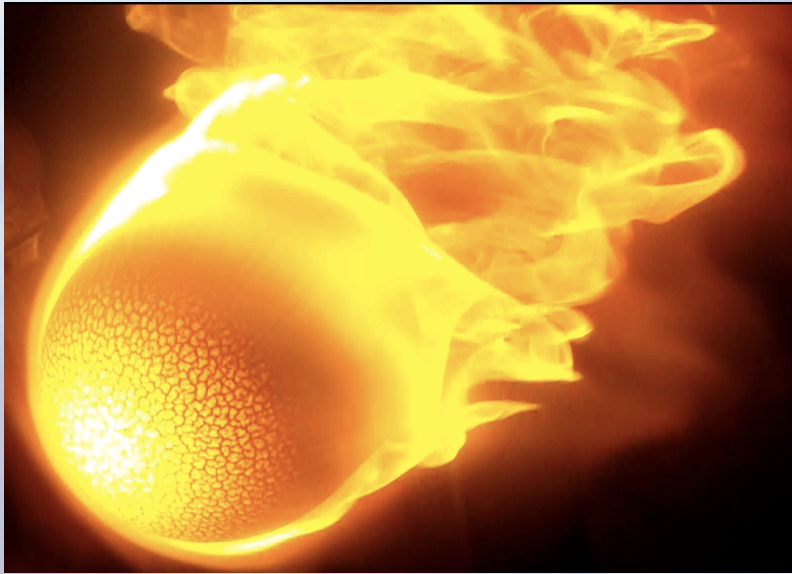

**Reference:** Bailet, G., Şakraker, I., Scholz, T., Muylaert, J. (2012). Qubesat for Aerothermodynamic Research and Measurement on Ablation. *9th International Planetary Probe Workshop*. Toulouse.



Cork P50 (Amorim)

# QARMAN Platform

-Thermal Protection System sizing-

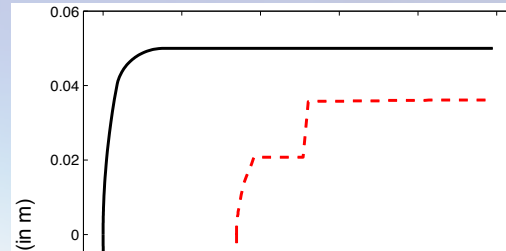

Future update of the design with a new EADS Astrium's light ablator ASTERM or AQ 61 which have higher performances

**Reference:** Bailet, G., Şakraker, I., Scholz, T., Muylaert, J. (2012). Qubesat for Aerothermodynamic Research and Measurement on Ablation. *9th International Planetary Probe Workshop*. Toulouse.



Cork P50 (Amorim)

