



**HAL**  
open science

## SiC lateral Schottky diode technology for integrated smart power converter

Jean-François Mognotte, Christophe Raynaud, Mihai Lazar, Bruno Allard,  
Dominique Planson

► **To cite this version:**

Jean-François Mognotte, Christophe Raynaud, Mihai Lazar, Bruno Allard, Dominique Planson. SiC lateral Schottky diode technology for integrated smart power converter. 2018 IEEE ICIT, Feb 2018, Lyon, France. 10.1109/ICIT.2018.8352287 . hal-01864545

**HAL Id: hal-01864545**

**<https://hal.science/hal-01864545>**

Submitted on 9 May 2019

**HAL** is a multi-disciplinary open access archive for the deposit and dissemination of scientific research documents, whether they are published or not. The documents may come from teaching and research institutions in France or abroad, or from public or private research centers.

L'archive ouverte pluridisciplinaire **HAL**, est destinée au dépôt et à la diffusion de documents scientifiques de niveau recherche, publiés ou non, émanant des établissements d'enseignement et de recherche français ou étrangers, des laboratoires publics ou privés.

# SiC lateral Schottky diode technology for integrated smart power converter

J. F. MOGNIOTTE

Université de Lyon INSA-Lyon, ESTA School of business  
and Technology, CNRS, AMPERE, UMR 5005  
F-69621, Villeurbanne, France  
jean-francois.mogniotte@insa-lyon.fr

C. RAYNAUD, M. LAZAR, B. ALLARD, D.  
PLANSON

Université de Lyon INSA-Lyon, CNRS, AMPERE,  
UMR 5005  
F-69621, Villeurbanne, France

**Abstract**— Ampere laboratory develops a technology of lateral power integrated circuit in Silicon Carbide (SiC). The purpose is to establish integrated power converter with its driver, which can operate in harsh environment. The technology is namely consisted by lateral MESFETs and lateral diodes. This paper presents two types of manufactured diodes: rectifier Schottky diode and power Schottky diode.

**Keywords:** SiC, Schottky diode, electrical characteristics, power converter

## I. INTRODUCTION

The needs of an electronic, which can operate in harsh environments is increased specially for applies as drilling, electrical vehicle, electrical aircraft, space probe... For answering of this problematic, AMPERE lab with the collaboration with the National Center of Electronic of Barcelona have considered the development of an integrated circuit technology in Silicon Carbide (SiC). The property of this material (SiC) allows to surpass the physical limits of the current solutions (working in high temperature, improving of the electrical yield thanks to the decrease of the electrical losses, increasing of the working frequency, weight reduction...). The purpose of this working is to develop a technology for integrated power converter dedicated to the harsh environments. The considered demonstrator is presented in Fig.1. It is an AC/DC converter with a full bridge rectifier for the first stage and a boost topology for the stage of the power converter. The driver would be integrated on the same SiC cheap than the power devices M1 (power MESFET) and D1 (power diode). The diodes of the full bridge rectifier (D2, D3, D4 and D5) will be too integrated on the same substrate than the previous devices. The passives devices (resistor, inductor and capacitor) will be discrete components. The developed integrated circuit SiC technology is in majority consisted by lateral transistors (MESFETS) with many current calibers (signal, buffer and power), which have been previously presented in Ref [1], but also by lateral diodes. These diodes have specific internal function in the considered power systems (rectifier, power transmission, electrical protection...). The research is mainly on the vertical devices for especially the properties of the breakdown voltage and the power density. However, some lateral in SiC have been designed and manufactured. In [2], a RESURF Schotkky 3C-SiC on Si have

been characterized with a breakdown voltage of 1200 V and a  $R_{on}$  of 4 m $\Omega$ /cm<sup>2</sup>. The ref [3] presents a PN diode with a breakdown voltage of 400 V. A lateral diode based electrostatic discharge (ESD) have been designed for the protection of the circuit in silicon-on-insulator (SOI). This device has respectively operated until 300 °C with a leakage current of 25 pA for an active area of 700  $\mu$ m<sup>2</sup> [4]. The state-of-art presents some lateral diode in SiC but this type of device for integrated power system is still not widespread. This paper will present the physical description and the electrical features for two typical diodes of the IC-SiC technology: the Schottky diode rectifier and the power Schottky diode.

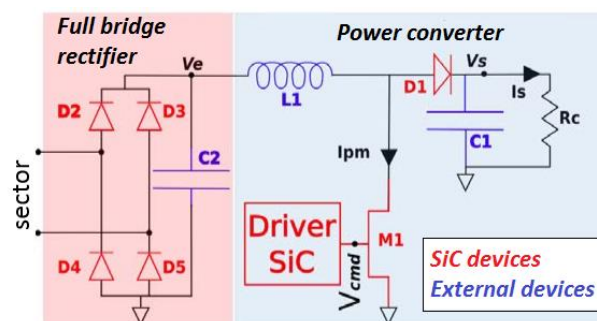

Fig. 1. Electrical schematic of the considered AC/DC demonstrator with a full bridge rectifier and a boost converter.

## II. EXPERIMENTAL DETAILS

### A. Measuring equipment

The devices have been manufactured by the National Center of Microelectronics of Barcelona on a SiC wafer, whose the size is 3 inches. A semi-automatic probe station (Fig. 2) associated to a Keysight B1505 analyser have been used for performed the electrical measures of the lateral Schottky SiC diodes. The electrical characterizations of the Schottky diodes have been made in forward conduction in first time and in reverse conduction in second time with the described equipment.

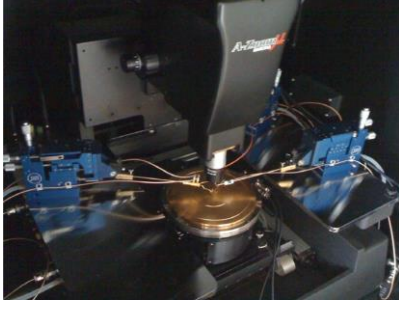

Fig. 2. Semi-automatic probe-station with 3 micromanipulators

### B. Equivalent model of the diode and extracted parameters

The sizing of the diodes is established on a simplified model of the diode (Fig. 3, left). The model is constituted by  $V_{di}$  (internal potential) and  $R_s$  (state-on resistance) in series.

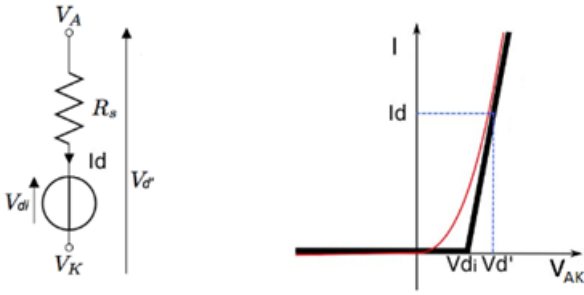

Fig. 3. Left: Equivalent model of the Schottky diode used for the sizing of the diodes. Right: Simplified ohmic behavior for a diode in forward conduction ( $I=f(V_{AK})$ ).

$$V_{di} = V_{d'} - R_s \cdot I_d \quad (1)$$

$$R_s = \frac{V_{d'} - V_{di}}{I_d} \quad (2)$$

The simplified model is described in the equations (1) and (2). The parameters  $V_{di}$  and  $R_s$  will be extracted from this model (Fig.3, right). The extraction of these parameters is based on the empirical methodology proposed by P. Antognetti and G. Massabrio [5]. For the analysis of the diodes, three parameters will be extracted from the electrical measures and the equations (1) and (2). It is the internal potential  $V_{di}$ , the state-on resistance by unit of length ( $R_s/l$ ) and the leakage current. The extracted parameters will have approximate values compared to the theory. This is not disturbing for the analysis because the purpose is to compare the manufactured devices between them with the same criteria.

### C. Theoretical values and sizing of the Schottky diodes

The diodes have been sized according to the considered power converter. The sizing of the demonstrator has been presented at [6]. The power diode must have a current of 2.85

A @ 1 V. It is represented a power density of 4.28 mA/mm. The power diode will have a width junction of 660 mm.

The extracted internal potential  $V_{di}$  will be compared to the theoretical internal potential  $V_{di}$  of the diode. It would not exactly the same value because a simplified model is used for the extraction of the features. However, the values will be normally very close. The theoretical value of the internal potential is determined from (3).

$$q \cdot V_{di} = q \cdot (E_g + \phi_s + \phi_M) \quad (3)$$

with:  $E_g$ : Bandgap (eV),  $V_{di}$ : Internal potential (V),  $\phi_s$ : Semi-conductor work (eV),  $\phi_M$ : Metal work (eV),  $q$ : Electron charge (C)

From [7], the metal work  $\phi_M$  of the nickel is 5.4 eV. For the SiC,  $\phi_s = 3.0$  (eV) and  $E_g = 3.2$  (eV) [8]. In replacing these values in the equation (3),  $V_{di}$  is equal to 0.8 V. It is a coherent value for a Schottky diode in SiC according to B. Baliga [9].

## III. SCHOTTKY DIODE RECTIFIER

### A. Description of the lateral Schottky diode

The lateral Schottky diode has been designed for being a rectifier diode with a width junction of 3.34 mm. This type of diode will be used for the full-bridge rectifier of the AC/DC converter, which has been presented on the Fig. 1 (D2, D3, D4 and D5). Two contact electrodes constitute the lateral diode: the anode (A) and the cathode (K). The cathode contact is the ohmic contact. It is based on a semi-conductor of type N. The anode is the Schottky contact. This contact is based on a nickel metallization. A cross view of the device is presented on the Fig. 4. The thickness of the layer N is  $0.5 \mu\text{m}$  ( $h_n$ ) and the thickness of the layer P is  $5 \mu\text{m}$  ( $h_p$ ). The junction length is  $10 \mu\text{m}$  ( $L_j$ ). The boxes P+ have the role to isolate the lateral diodes between them and the semi-insulating substrate the devices from the backside of the SiC wafer. The diode have an area of  $0.27 \text{ mm}^2$ . The Fig. 5 presents the top view of one manufactured diode.

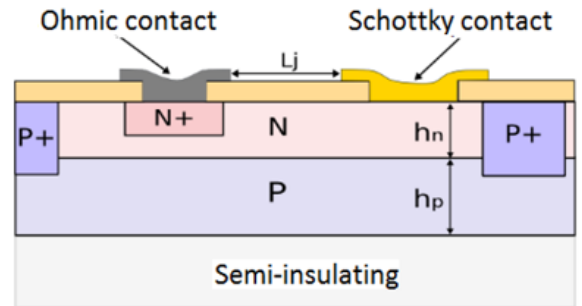

Fig. 4. Cross view of the lateral Schottky Diode. A and K represent the anode and the cathode.  $h_n$  is the thickness of the layer N.  $h_p$  is the thickness of the layer P.  $L_j$  is the length of the junction.

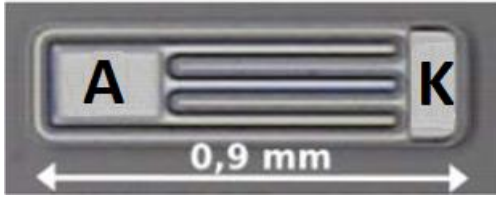

Fig. 5. Top view of one manufactured diode with a width junction of 3.34 mm and a length junction of 10  $\mu$ m.

## B. Electrical characterizations

The protocol of the characterizations is presented on the part II. The diodes have been measured directly on the SiC wafer at room temperature. The Fig. 6 and the Fig.7 present respectively the static characteristic  $I_A=f(V_{AK})$  of the diode for the forward conduction and the reverse conduction.

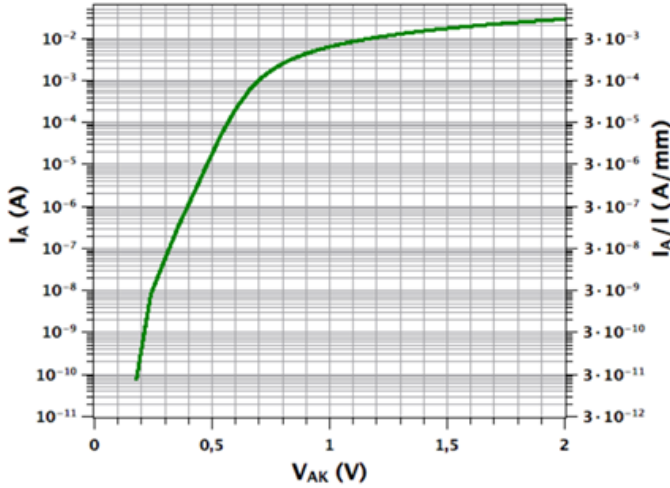

Fig. 6. Experimental static characteristic  $I_A=f(V_{AK})$  in forward conduction for a rectifier Schottky diode with a width junction of 3.34 mm

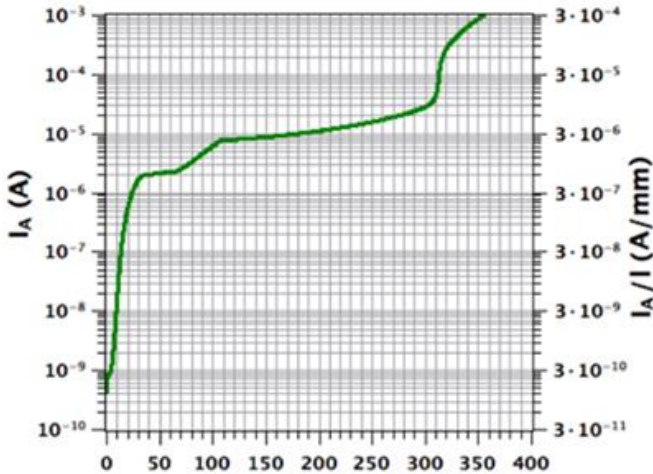

Fig. 7. Experimental static characteristic  $I_A=f(V_{AK})$  in reverse conduction for a rectifier Schottky diode with a width junction of 3.34 mm

## C. Analysis of the experimental measures

The experimental measures indicate that the device has the typical behavior of a Schottky diode. The current is passing in forward conduction for an internal potential  $V_{di}$  of 0.8 V, a forward current of 8 mA @ 1 V. The extracted value is very close than the theoretical value, which has been calculated in the part II (0.8 V). In reverse conduction, the current is blocked. The diode can hold a voltage until 310 V with a leakage current of 3  $\mu$ A/mm. Beyond this voltage value, the leakage current becomes too important and can reach a value of 0.3 mA/mm @ 354 V. The experimental measures have been performed on 72 diodes. This value is good and is near of the breakdown voltage of a lateral diode presents in [3]. The diodes are working and they have all the same electrical behavior. The parameters  $V_{di}$ , the  $R_S/I$  and the leakage current have been extracted from the methodology indicated in the part 2. The results are on the table 1.

TABLE I.

| Feature                            | Average | $\sigma$ | $\sigma$ -low | $\sigma$ -high |
|------------------------------------|---------|----------|---------------|----------------|
| $V_{di}$ (V)                       | 0.79    | 0.08     | 0.71          | 0.88           |
| $R_S/I$ ( $\Omega$ /mm)            | 2.63    | 0.16     | 2.47          | 2.79           |
| $I_{leak/I}$ @ -50 V ( $\mu$ A/mm) | 0.4     | 0.13     | 0.27          | 0.53           |

Table 1. Synthesis of the features extracted from the measurements of 72 Schottky diodes for a width junction of 3.34 mm.  $\sigma$  is the standard deviation,  $\sigma$ -low is the average -  $\sigma$  and  $\sigma$ -high is the average +  $\sigma$ .

The internal potential  $V_{di}$  present an average value of 0.79 V, which is near of the theoretical value for the Schottky diode (0.80 V). The difference is of 1.25 % between the theoretical value and the average of the experimental values. This parameter is globally stable on the whole of the devices. The diodes have a high value of the  $R_S/I$  (2.63  $\Omega$ /mm). It is impact the value of the current density, which is weaker than expected for the demonstrator. The results put forward the problems of the contact resistance, which has been already observed for the MESFET technology [1]. The leakage current presents an average value of 0.40  $\mu$ A/mm for a reverse voltage of 50 V. The rectifier diode is validated, but the technology of the contact resistance must be improved for increasing the current density.

## IV. SCHOTTKY POWER DIODE

### A. Description of the lateral power Schottky diode

A power diode has been designed and integrated on the same wafer than the MESFETs and the rectifier diodes. Initially, the power diode would have a width junction of 660 mm. Nevertheless, this size involved that 65% of the area of the field was for this device. It has been decided to reduce the area of the power diode. For maintaining an identical current density, the new junction has been sized at 21.5 mm. This

diode would be used as the Freewheel diode for the boost converter (diode D1, Fig.1). The Fig.8 presents a top view of a manufactured power diode. This device is based on the same topology than the lateral Schottky diode (Fig. 4). However, for having a more important value of the current across the diode, the surface of the contact electrodes have been increased and a second electrode has been added for the cathode (K). This topology is equivalent as the paralleling of two diodes as indicated on the Fig. 9. The diode has an area of 1.5 mm<sup>2</sup>.

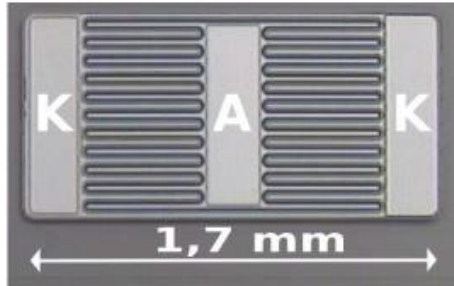

Fig. 8. Top view of the manufactured diode with a width junction of 21.7 mm and a length junction of 10 μm.

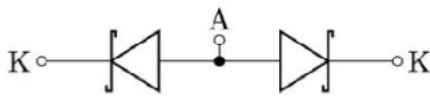

Fig. 9. Equivalent schematic of the power diode. A is the anode and K is the cathode.

### B. Electrical characterizations

As in the part III, the protocol of the characterization is identical as the part II. The Fig. 10 and the Fig.11 present respectively the static characteristic  $I_A=f(V_{AK})$  of the power diode for the forward conduction and the reverse conduction.

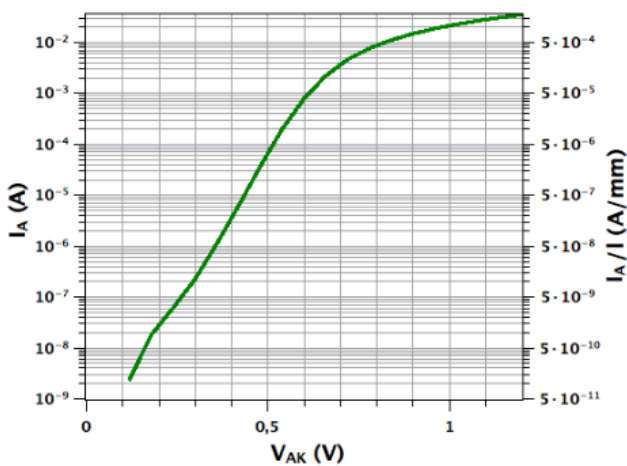

Fig. 10. Experimental static characteristic  $I_A=f(V_{AK})$  in forward conduction for a rectifier Schottky diode with a length junction of 21.7 mm

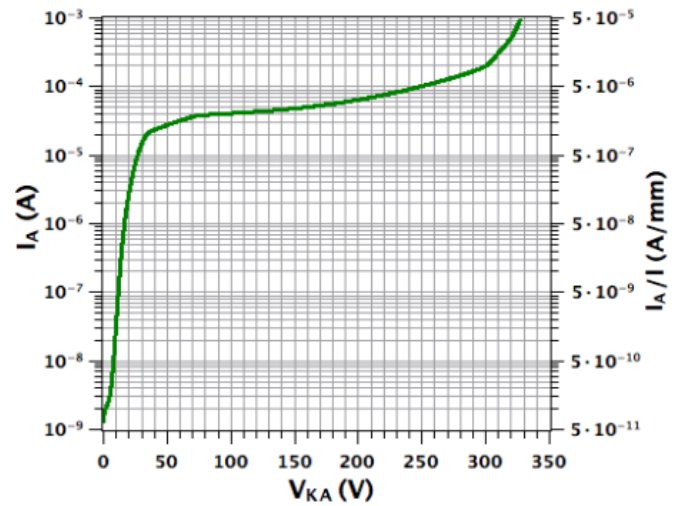

Fig. 11. Experimental static characteristic  $I_A=f(V_{KA})$  in reverse conduction for a rectifier Schottky diode with a length junction of 21.7 mm

### C. Analysis of the experimental measures

The measures show that the power diode has the behavior of a typical Schottky diode. The power diode presents an internal potential  $V_{di}$  with a value 0.70 V, a current of 20 mA @ 1 V and can hold a reverse voltage of 250 V for a leakage current @ 5 μA/mm. Beyond this voltage value, the leakage current becomes too important and can reach a value of 50 μA/mm at 327 V. The experimental measures have been made on 41 manufactured diodes. The diodes present the electrical behavior expected for a Schottky diode. The parameters have been extracted as the same way than in the part III. The experimental results are indicated on the Table 2.

TABLE II.

| Feature                            | Average | $\sigma$ | $\sigma$ -low | $\sigma$ -high |
|------------------------------------|---------|----------|---------------|----------------|
| $V_{di}$ (V)                       | 0.70    | 0.04     | 0.66          | 0.74           |
| $R_S/l$ ( $\Omega$ /mm)            | 626     | 36       | 590           | 660            |
| $I_{leak/l}$ @ -50 V ( $\mu$ A/mm) | 0.75    | 0.16     | 0.59          | 0.91           |

Table 2. Synthesis of the features extracted from the measurements of 41 Schottky power diodes for a width junction of 22.1 mm.  $\sigma$  is the standard deviation,  $\sigma$ -low is the average -  $\sigma$  and  $\sigma$ -high is the average +  $\sigma$ .

The value of  $V_{di}$  is globally stable for all the measured diodes. The theoretical value of  $V_{di}$  is 0.8 V, the difference with the experimental average value of the table 2 is 14.28 %. This difference can be explain by the doping N or by the metallization (area is more important than the rectifier diode), which could affect the value of the work metal (formula 1). The  $R_S/l$  (626 m $\Omega$ /mm) has a value more important than expected. However, this value is four times less important than the rectifier diode (2.63  $\Omega$ /mm). These high values of the  $R_S$  depend on the values of the contact resistances as indicated for

the rectifier diode. The power diode has been designed for a theoretical value for the current density of 4.28 mA/mm and a current of 0.09 A @ 1 V. The experimental value is 0.92 mA/mm and 0.02 A @ 1 V. The difference is 78 %. The gap is important between these values, the power diode is functional but the contact resistance of the power diode must be improved in the following batches for using the device as power switch for the power converter demonstrator.

## V. EFFECT OF THE POLARIZATION OF THE BACKSIDE OF THE WAFER ON THE VOLTAGE OF THE SCHOTTKY DIODE

The polarization of the backside presents an effect on the Schottky diode. The topology is similar for the both diodes. The analysis has been performed on the rectifier diode, but it would be similar for the power diode. The behavior in reverse conduction of a rectifier Schottky diode has been measured in three configuration C1, C2 and C3. The configuration C1 is presented on the Fig. 12 The anode of the device is connected to the backside of the substrate. The C2 configuration has been for the experimental measures. In the case or the substrate is floating. The configuration C3 is presented on the Fig. 13. The backside of the substrate is connected to the cathode of the diode. The Fig. 14 indicated the comparison of the experimental measures for the three configurations. It appears that the polarization of the backside influences the behavior of the current across the diode. The case C1 gives the features the less interesting. The diode reaches 1 mA @ 290 V against 50  $\mu$ A in the configuration C2 and 40  $\mu$ A in the configuration C3. In the case C2, the substrate is self-polarized. The leakage current reaches a value of 1 mA.

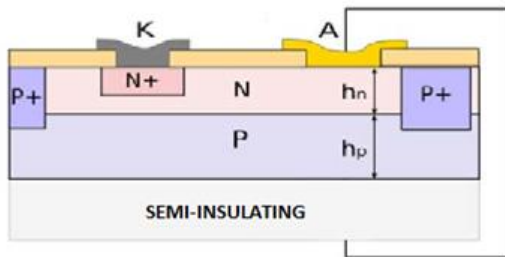

Fig. 12. Principle for the configuration C1, which has been used for the reverse conduction of the power diode. The cathode (K) is connected to the metallization of the backside.

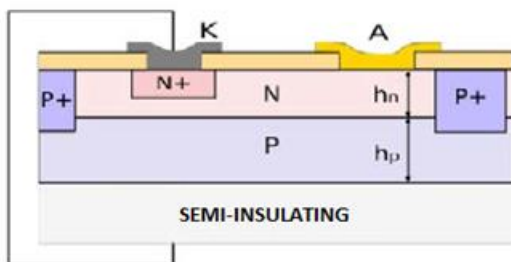

Fig. 13. Principle for the configuration C3, which has been used for the reverse conduction of the power diode. The anode (C) is connected to the metallization of the backside.

for a voltage of 320 V. The best configuration is C3 because the leakage current is at 1 mA for a voltage of 335 V. W. S. Lee has demonstrated on [10] that an increase of the thickness  $h_p$  from the layer P of 5  $\mu$ A to 20  $\mu$ A allows to increase the breakdown voltage from 600 V to 2.4 kV. The C2 and C3 configurations indicate the presence of a plateau between 70 V and 100 V. A considered hypothesis will be a progressive depletion of the space charge area, which could be faster than in the configuration C1. An analysis of the diode by the finite elements is necessary for a more precise understanding of the observed behaviors. This analysis could be to optimize the features of the diodes and to increase the holding in tension of the device.

## VI. CONCLUSION

The lateral diode Schottky technology for a smart power integrated circuit has been presented in this paper. Two types of diodes have been sized, manufactured and characterized. These diodes are a Schottky rectifier and Schottky power diode. The both diodes are working. In forward conduction, a current is passing and the current is blocked in reverse conduction. The diodes can hold a reverse voltage up to 331 V for the rectifier diode and 250 V for the power diode. This value can be improved in the following batches by an optimization of the devices. The main parameters of the diode have been extracted. These parameters allow to compare the diodes between them. It appears that the  $V_{di}$  is close to the theoretical value (0.8 V). However, the power density of the both diodes is too weak according to the expected value. This difference can be explained by the high value of the contact resistance, which has been already detected for the MESFET technology. The diodes are functional, the technology is validated but it is necessary to decrease the value of the contact resistance in the next batch for having diodes with the expected forward current.

The future work will be focus on a first time on the optimization of the main properties for the Schottky diodes (breakdown voltage, improvement of the power density, improvement of the leakage current...). In a second time, the purpose will be to develop a range of diodes for enriching the available lateral devices of the SiC technology (ESD protection, rectifier, power, signal, zener...). These diodes are normally designed for operating in high temperature (> 200 °C). These devices will be tested in temperature for determining the working limits. The final purpose is to use these diodes in the considered demonstrator for the smart power system in SiC, which could operate in high temperature.

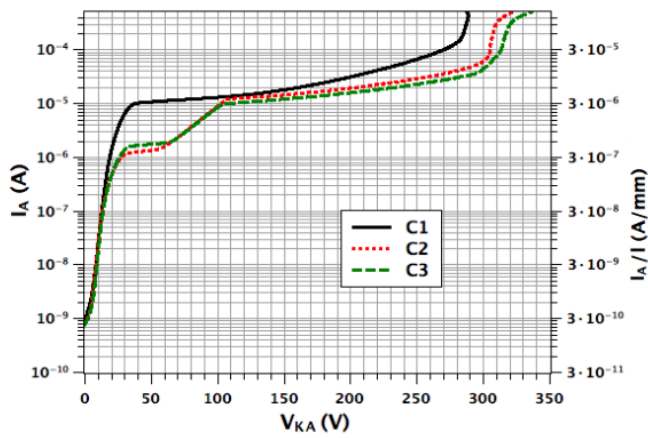

Fig. 14. Reverse conduction of the current  $I_A=f(V_{AK})$  for a rectifier diode in the configurations C1, C2 and C3.

#### REFERENCES

- [1] J. F. Mognotte, D. Tournier, C. Raynaud, M. Lazard, D. Planson and B. Allard, "Silicon-Carbide technology of MESFETs based power integrated circuits", Journal of Emergind and Selected Topics in Power Electronics. **To be published**
- [2] F. Li, Y. Sharma, M. Jennings, H. Rong, C. Fisher, P. Mawby, "Study of a novel lateral RESURF 3C-SiC on Si Schottky diode", 16th European Conference on Power Electronics and Applications, August 2014, Lappeeranta (Finland).
- [3] M. Miura, S. Nakamura, J. Suda, T. Kimoto, H. Matsunami, "Fabrication of SiC lateral super junction diode with multiple stacking p- and n-layers" IEEE Electron Device Letters, vol 24, 5, 321-323, july 2003
- [4] R. Ghandi, C. P. Chen, A. S. Kashyap, E. Andarawis, " SiC Lateral Diodes for ESD protection of High Temperature Integrated Circuits, HiTEN, vol 15, 1-4, 2015
- [5] P. Antognetti, G. Massabrio, "Semiconductor Device Modeling with SPICE", New-York, McGraw-Hill Book Company, Chap1 and Chap 3, 1987.
- [6] J. F. Mognotte, D. Tournier, D. Planson, P. Bevilacqua, P. Godignon, "Design of an integrated power converter in Wide Band Gap for harsh enironments" 7th Conference on Integrated Power Electronics Systems (CIPS), March 2012, Nuremberg (Germany), pp. 1-6.
- [7] D. Perrone, "Process and characterisation techniques on 4H-Silicon Carbide", PhD Thesis, Polytechnic school of Torino, 133 p., 2007.
- [8] H. Mathieu, H. Fanet, "Physique des semiconducteurs et des composants électroniques", ISBN: 978-10-051643-8, Dunod, 6<sup>th</sup>, 2009.
- [9] J. Baliga, "Silicon Carbide Power Devices", ISBN-10/ 007149553, McGraw-Hill, 479 p., 1993.
- [10] W. S. Lee, K. W. Chu, C. F. Huang, L. S. LEE, M. J TSAI, K. Y. LEE and F. Zhao, "Design and fabrication of 4H-SiC lateral High Voltage devices on semi-insulating substrate", IEEE Transactions on Electronc devices, 59, 754-760, 2012.