



HAL
open science

Structural & Spectroscopic Study of InAs/InP Quantum Dots for Dual-Frequency Laser Engineering

Gaëlle Brévalle, Mathieu Perrin, Cyril Paranthoen, Christophe Levallois, Yoan Léger, Hervé Folliot, Mehdi Alouini

► To cite this version:

Gaëlle Brévalle, Mathieu Perrin, Cyril Paranthoen, Christophe Levallois, Yoan Léger, et al.. Structural & Spectroscopic Study of InAs/InP Quantum Dots for Dual-Frequency Laser Engineering. 16^e Journées Nano, Micro et Optoélectronique (JNMO 2018), Jun 2018, Agay, France. <hal-01859165>

HAL Id: hal-01859165

<https://hal.science/hal-01859165v1>

Submitted on 17 Oct 2018

HAL is a multi-disciplinary open access archive for the deposit and dissemination of scientific research documents, whether they are published or not. The documents may come from teaching and research institutions in France or abroad, or from public or private research centers.

L'archive ouverte pluridisciplinaire **HAL**, est destinée au dépôt et à la diffusion de documents scientifiques de niveau recherche, publiés ou non, émanant des établissements d'enseignement et de recherche français ou étrangers, des laboratoires publics ou privés.



HAL Authorization

Structural & Spectroscopic Study of InAs/InP Quantum Dots for Dual-Frequency Laser Engineering

G. Brévalle¹, M. Perrin¹, C. Paranthoën¹, C. Levallois¹, Y. Léger¹, H. Folliot¹, M. Alouini¹
¹Univ Rennes, INSA Rennes, CNRS, Institut FOTON – UMR 6082, F-35000 Rennes, France
gaelle.brevalle@insa-rennes.fr

Introduction

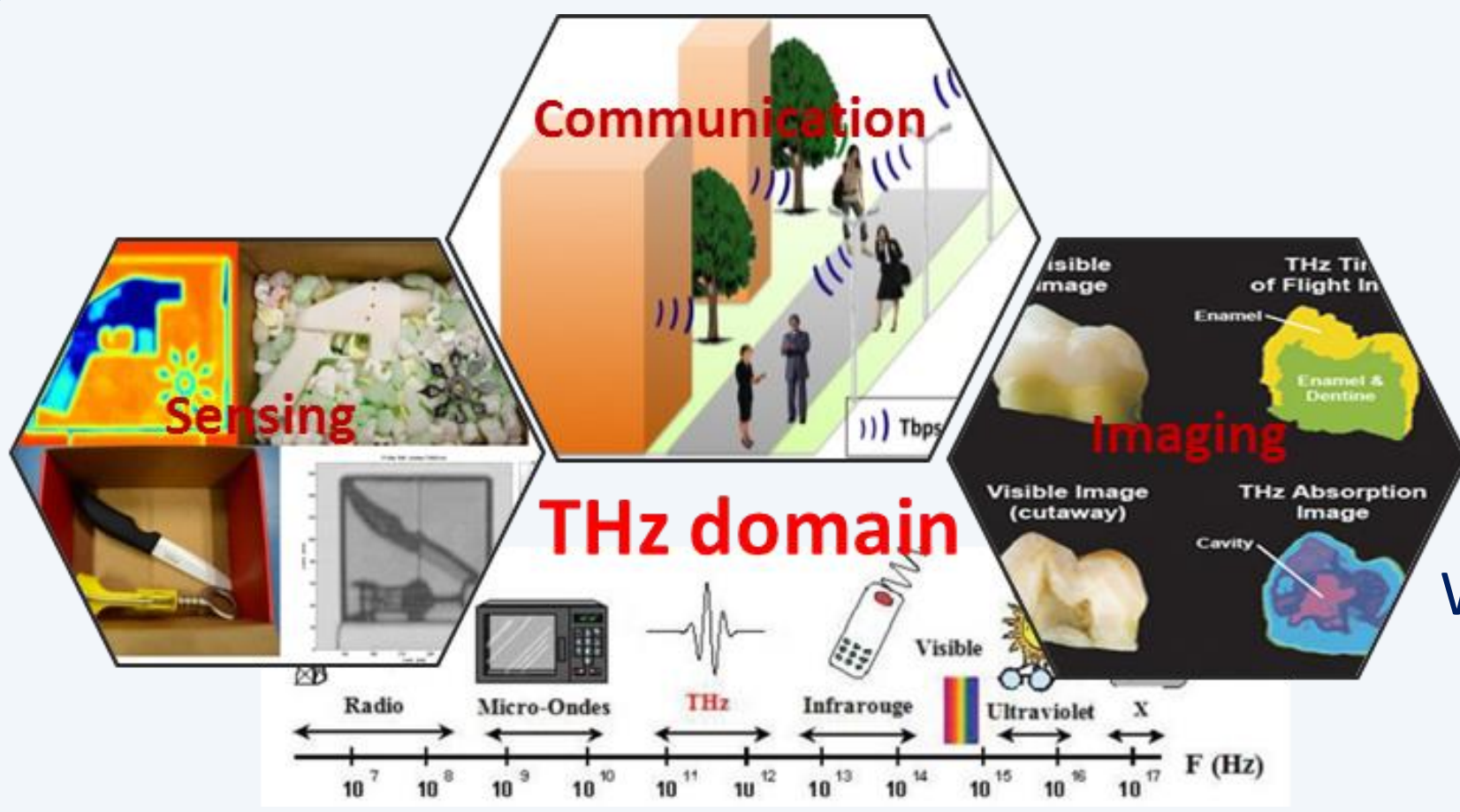

Problem
Few efficient compact tunable room temperature THz sources available

Wavelength beating from a Coherent dual wavelength Quantum Dots (QDs) based Vertical External Cavity Surface Emitting Laser (VECSEL)

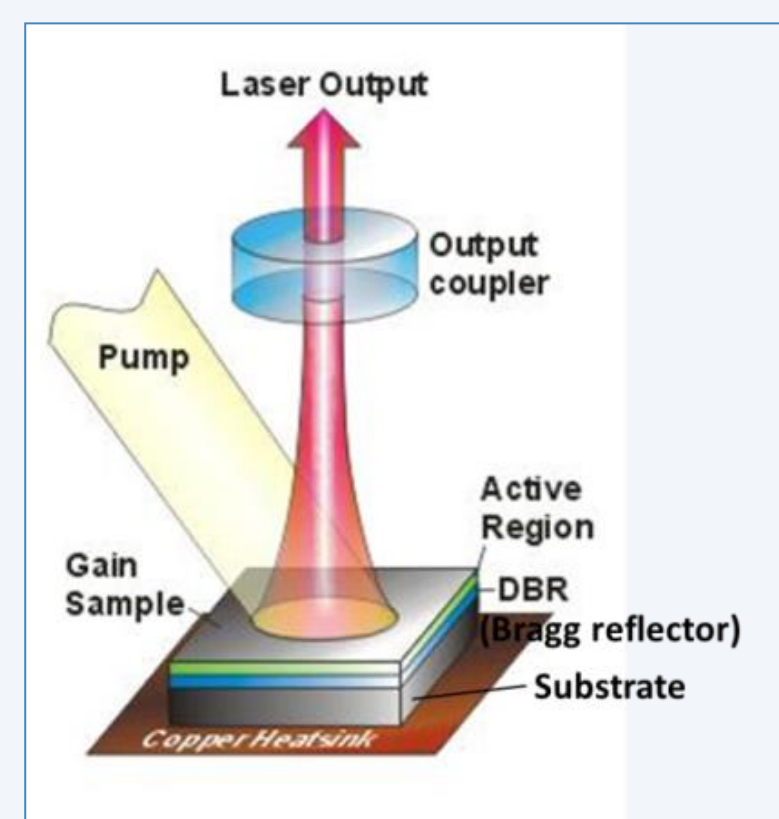

Why VECSEL ?

- Low intensity and phase noise
- Dual-wavelength regime possible

Why QDs ?

- Weak coupling (inhomogeneous medium)
- Possible electrical injection

Requirements for the QDs

InAs/InP QDs
Molecular Beam Epitaxy Growth parameters:
• AsH₃ Flow
• Quantity of deposited InAs

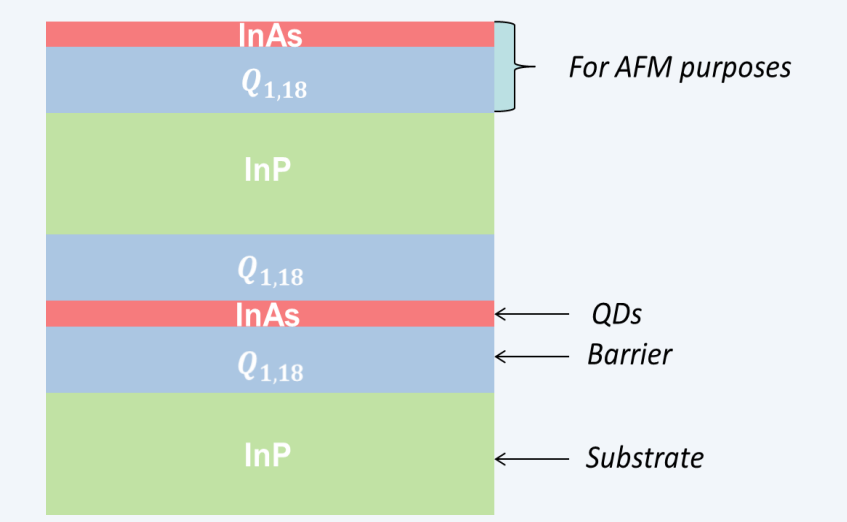

Telecom wavelength

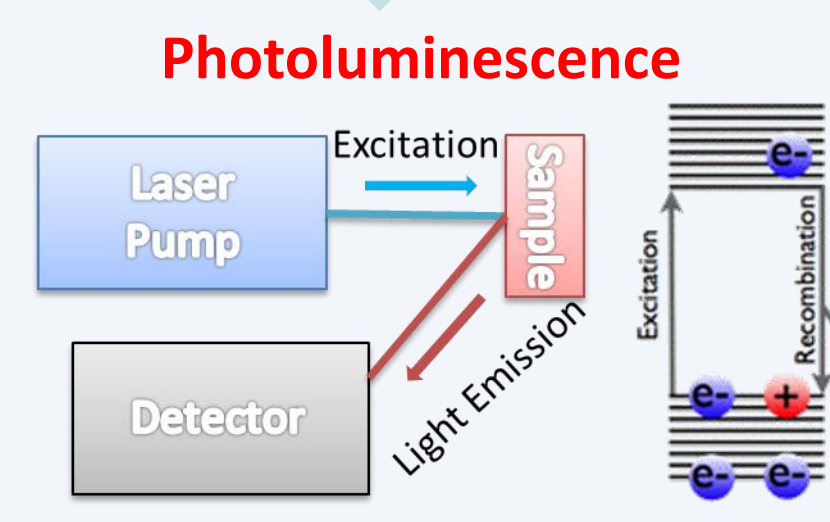

Weak Coupling

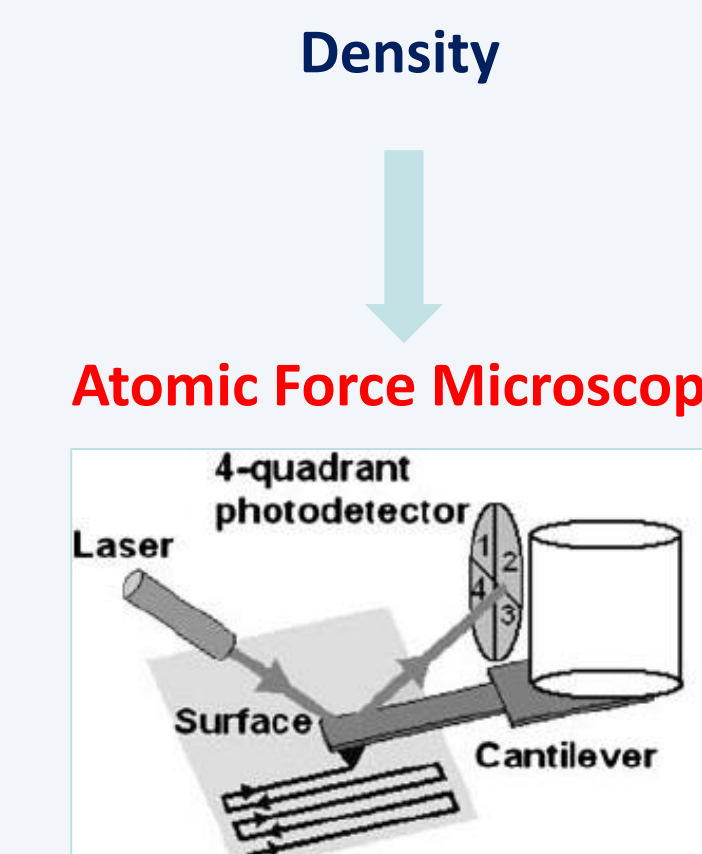

Homogeneous linewidth

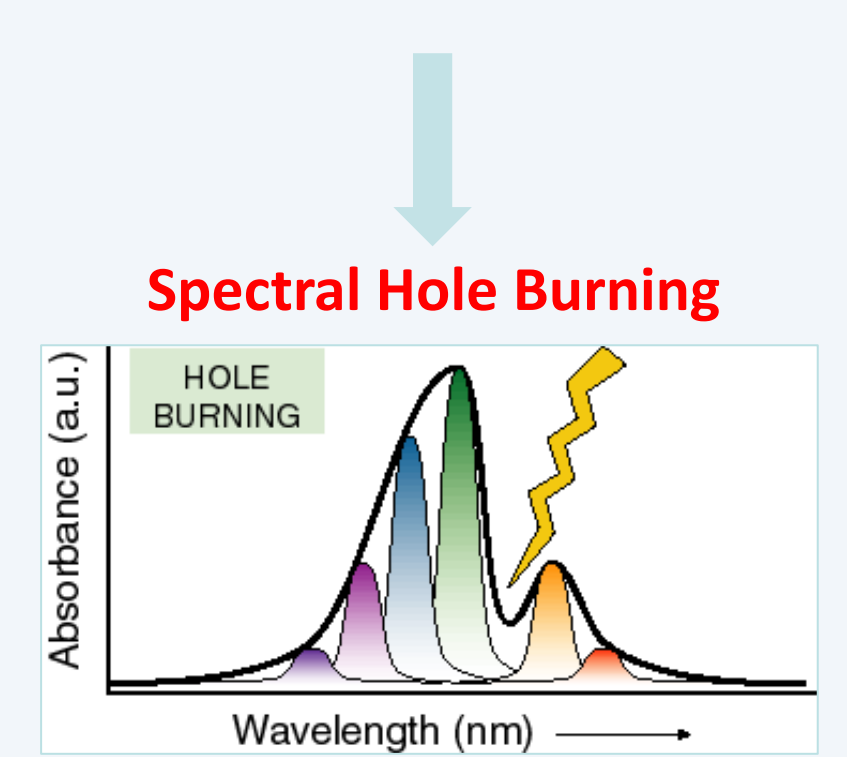

Tuning of the QDs density - AFM

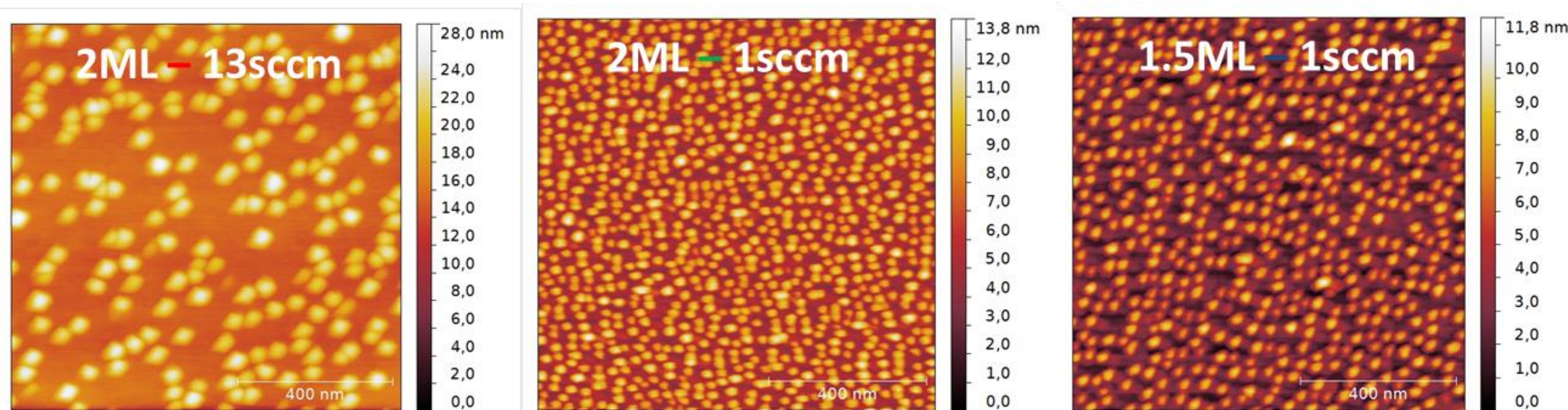

AFM images (1x1 μm²) of the InAs/InP Quantum Dots which have different growth parameters

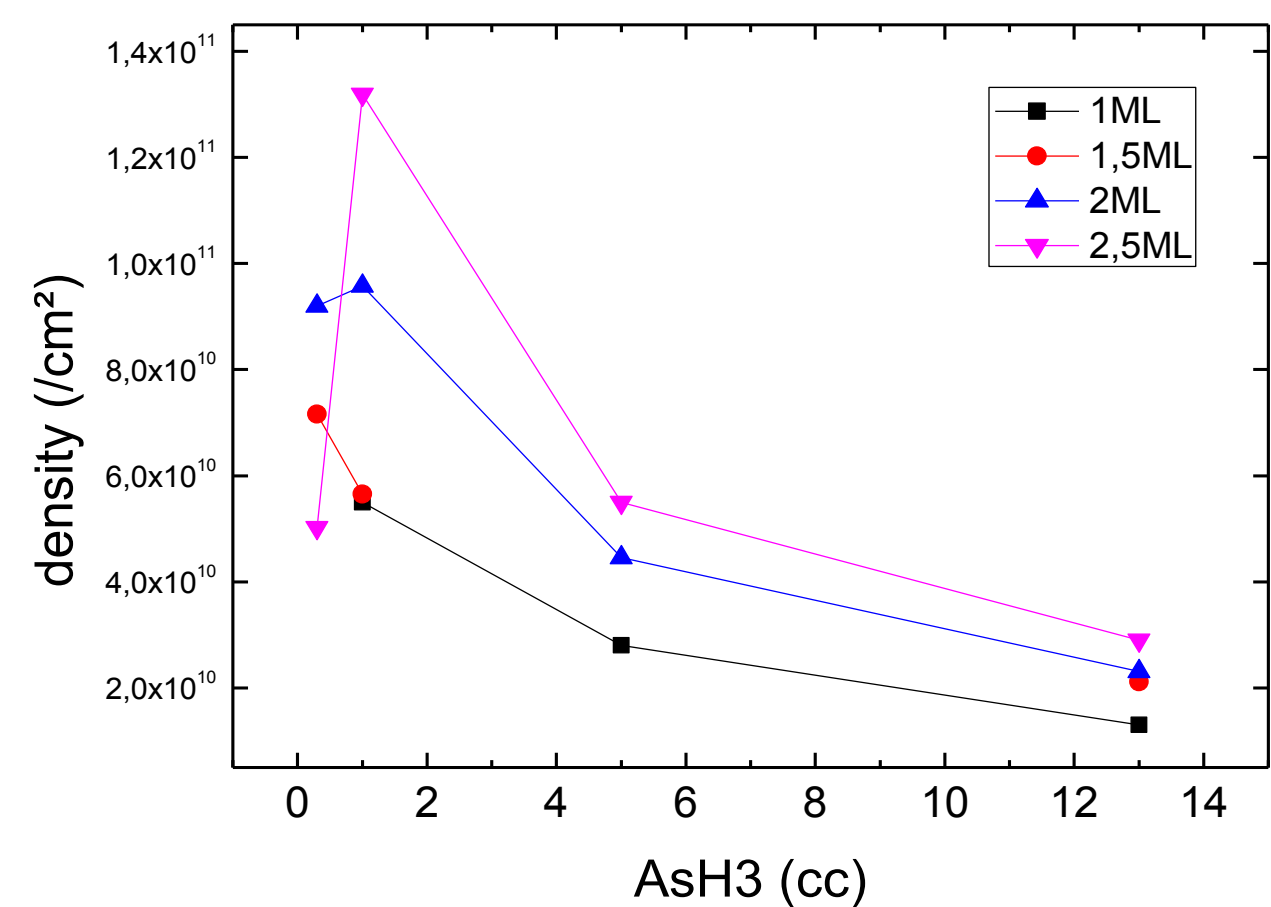

QDs density as a function of AsH₃ Flow
When the AsH₃ Flow increases, the QDs get bigger and the density greatly decreases (x10)

QDs size and emission wavelength

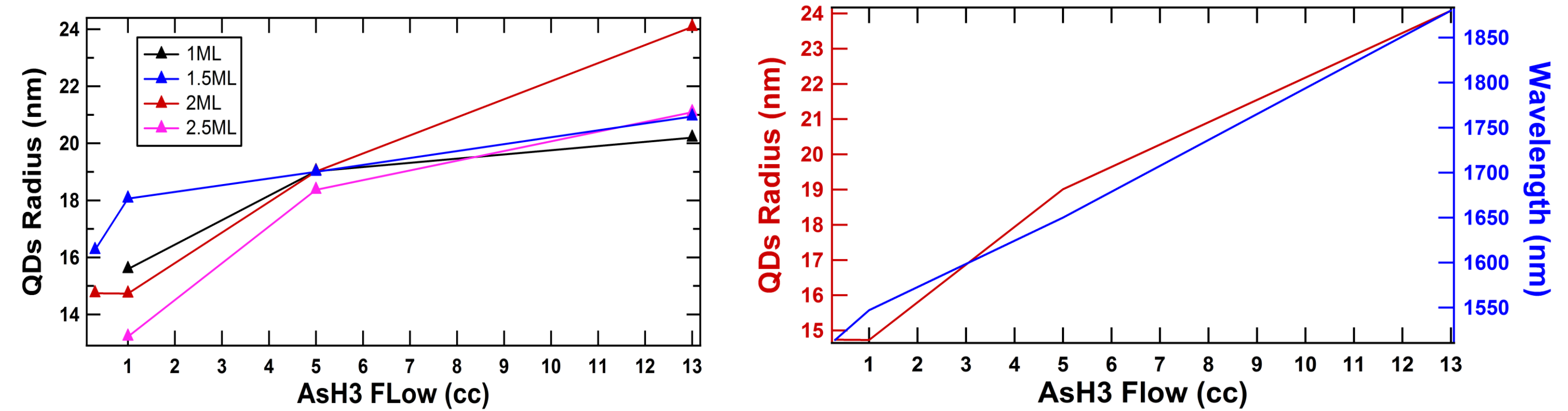

The radius of the QDs is bigger for higher flow

For 2ML: QDs radius and wavelength as a function of As Flow
Bigger QDs → Higher emission wavelength

QDs = self-assembled nanostructure → impossible to control the size and consequently the wavelength

Control of the wavelength – Double Cap

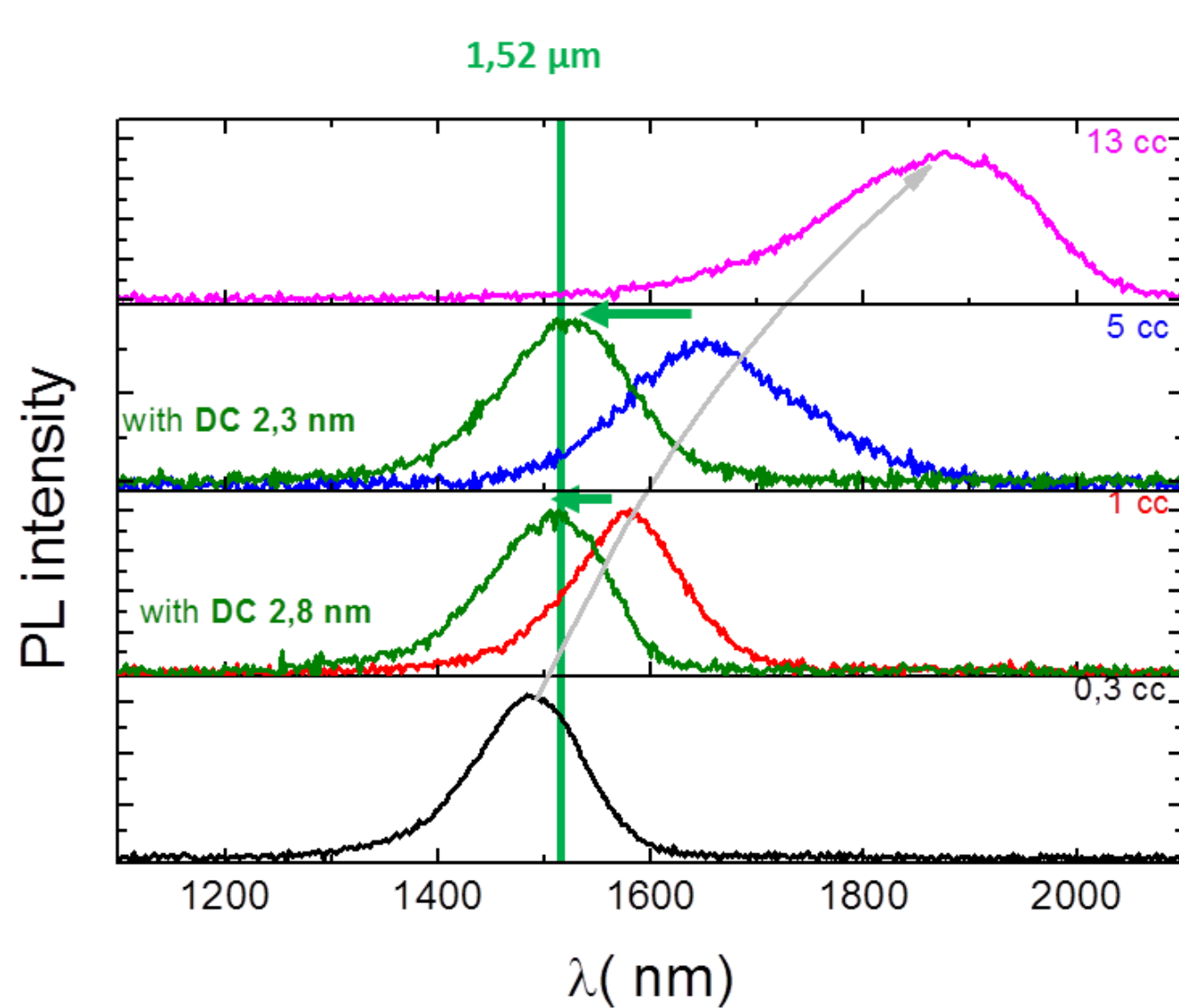

Emission Wavelength for different AsH₃ flow

QDs Wavelength: Tendency with growth parameters but impossibility to control it by only the growth

Double cap process

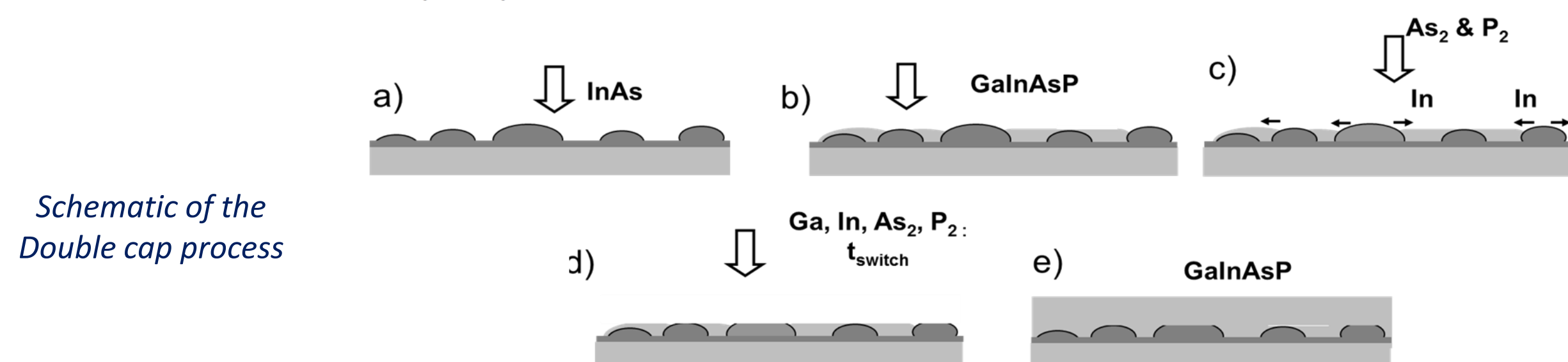

Schematic of the Double cap process

Spectral Hole Burning

Experimental Setup

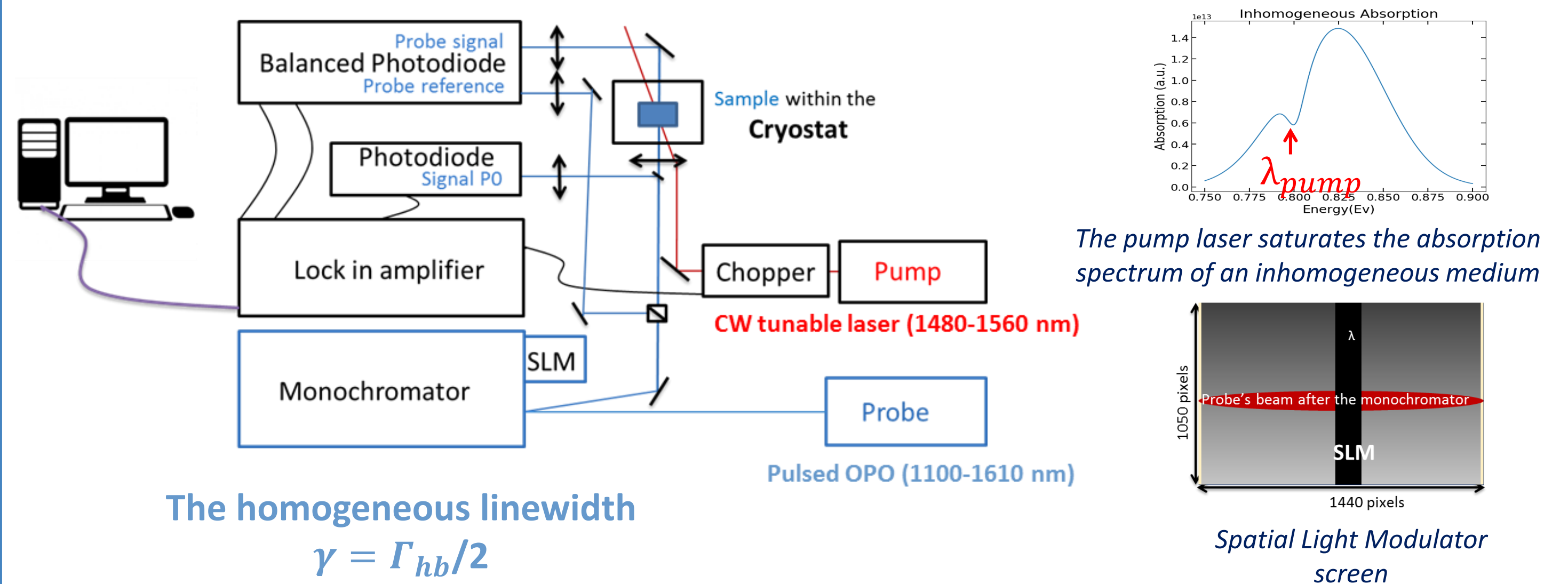

The pump laser saturates the absorption spectrum of an inhomogeneous medium

The homogeneous linewidth
 $\gamma = \Gamma_{hb}/2$

Preliminary Results (on QWs)

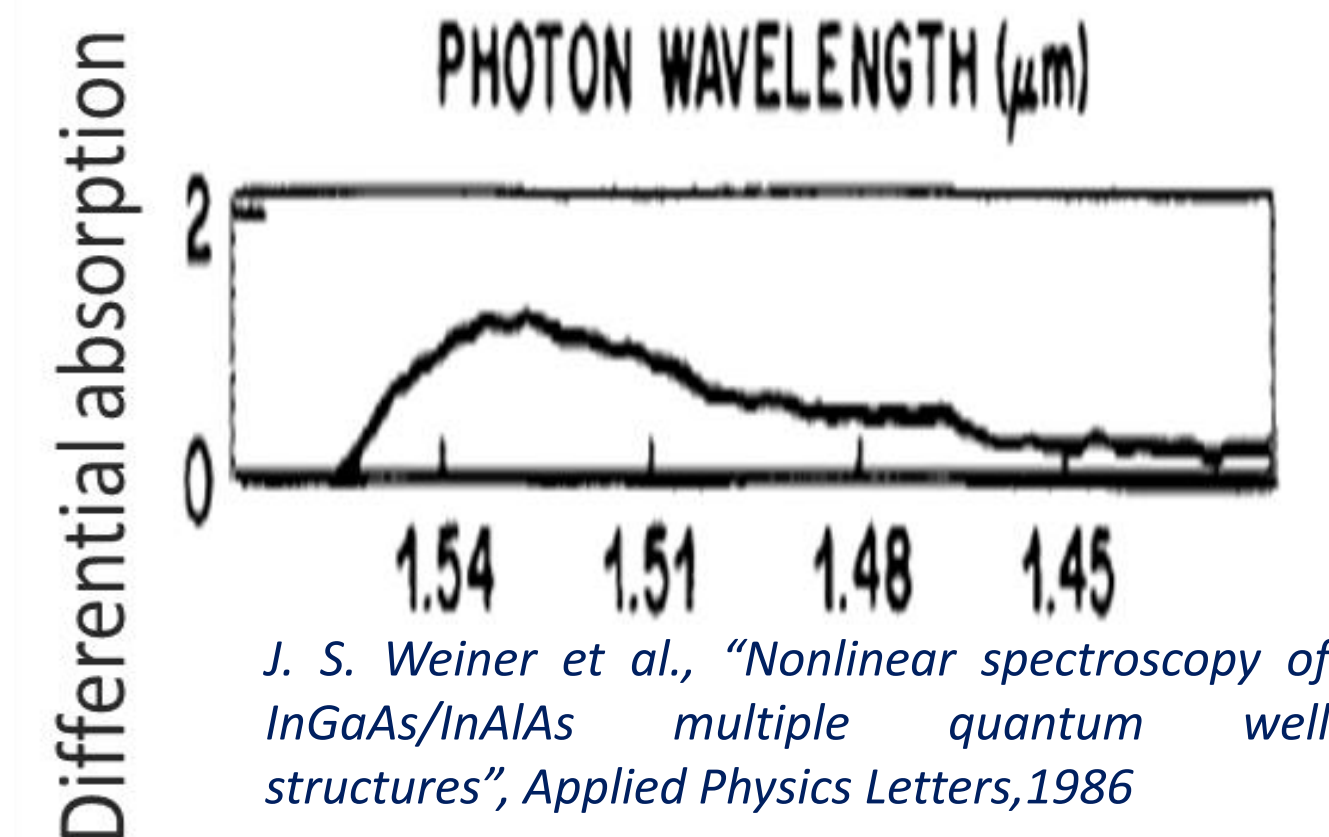
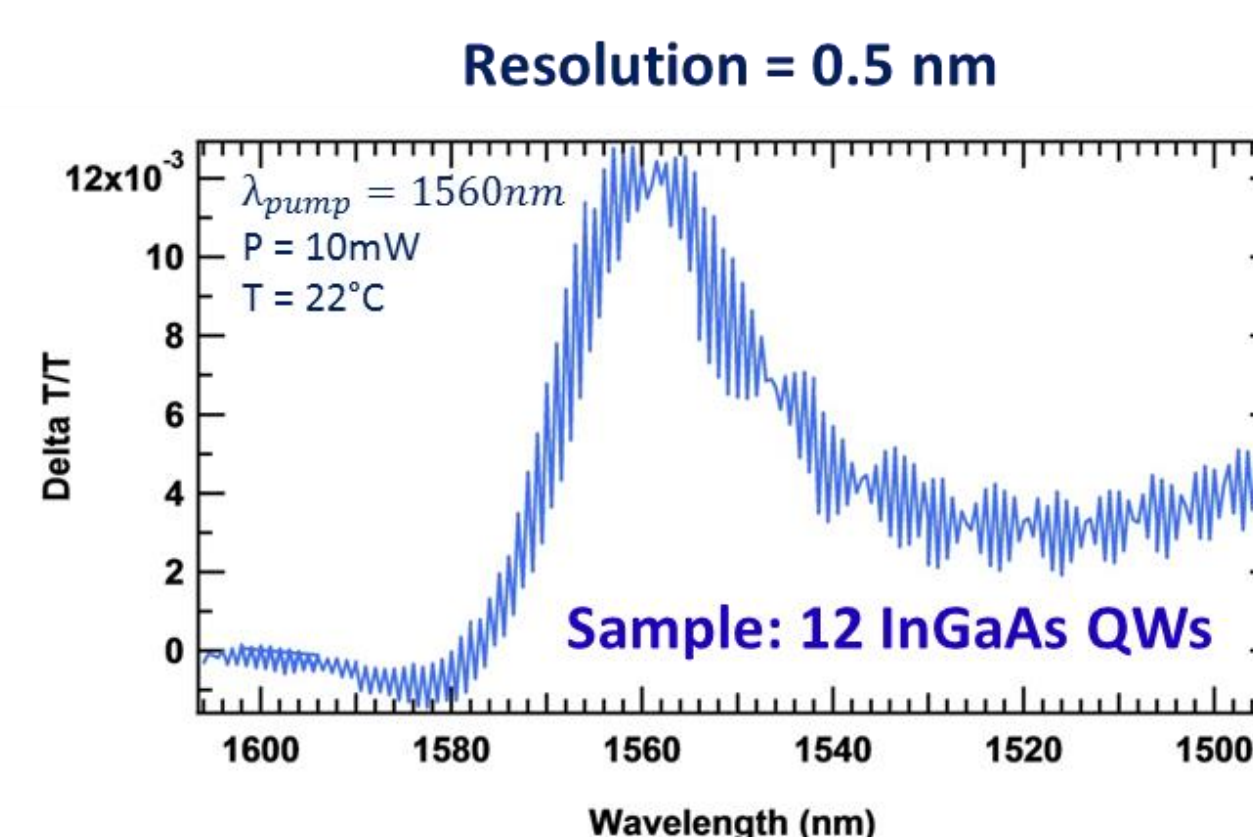

Experimental SHB spectrum and Reference

Same shape, good resolution (visible interferences due to the sample), higher spectral range
Typical characteristics of QWs: thermal carriers exponential decline, exciton photo-bleaching

Conclusion

- QDs density (and coupling) mainly controlled by the As flow: changed from 10¹¹ down to 10¹⁰ cm⁻², with a strong effect on the wavelength emission: from 1500 nm to 1945 nm
- Independent control of the density and wavelength (double cap)
- SHB experimental setup ready with good resolution (<0.5nm) and high spectral range (500 nm)
- Results on QWs correspond well with the bibliography

Perspectives

- Achievement of SHB in order to get the homogeneous linewidth broadening as a function of QDs density, temperature, input power
- Optimisation of QDs density to get the weaker coupling
- VECSEL characterisation