



HAL
open science

The Hassan mosque at the digital era.

Farouk Achakir, Marc Pierrot Deseilligny, Sanaa El Fkihi, Mina El Mghari,
Mohamed Ettarid, El Mustapha Mouaddib, Amina Radgui

► **To cite this version:**

Farouk Achakir, Marc Pierrot Deseilligny, Sanaa El Fkihi, Mina El Mghari, Mohamed Ettarid, et al..
The Hassan mosque at the digital era.. *Frontiers in Science and Engineering International Journal*,
2017, 7 (1), pp.45-58. hal-01850561

HAL Id: hal-01850561

<https://hal.science/hal-01850561>

Submitted on 27 Jul 2018

HAL is a multi-disciplinary open access archive for the deposit and dissemination of scientific research documents, whether they are published or not. The documents may come from teaching and research institutions in France or abroad, or from public or private research centers.

L'archive ouverte pluridisciplinaire **HAL**, est destinée au dépôt et à la diffusion de documents scientifiques de niveau recherche, publiés ou non, émanant des établissements d'enseignement et de recherche français ou étrangers, des laboratoires publics ou privés.

The Hassan mosque at the digital era.

Farouk Achakir^{1,4}, Marc Pierrot Deseilligny³, Sanaa El Fkihi², Mina El Mghari⁴
Mohamed Ettarid⁵, El Mustapha Mouaddib^{1,7} and Amina Radgui⁶

¹ UPJV, Laboratoire MIS, Amiens - France

² ENSIAS - Rabat - Maroc

³ ENSG - Marne la Vallée - France

⁴ Université Mohammed V de Rabat - Maroc

⁵ IAV - Rabat - Maroc

⁶ INPT - Rabat - Maroc

⁷ Corresponding Author E-mail : mouaddib@u-picardie.fr

Abstract.

About ten years ago, the double behest of late Driss Aboutajdine and El Mustapha Mouaddib permitted setting up research partnership on the use of image processing and cultural heritage. In 2015, despite his workload, Professor Driss Aboutajdine has put all his energy so a common complementary action could take place and occur, convening hence the numerical sciences, precisely 3D techniques, serving cultural heritage. This action went on to give birth to Athar-3D project, with the ambition to resolve questions pertaining to 3D modeling and computer vision having along a positive impact on cultural and architectural heritage perception. The research we carried out in this framework aims to the digitizing of Hassan Mosque, its reconstitution and the achievement of mechanism and application to heighten awareness and to better know and communicate about cultural heritage matter. To our knowledge, this is the first work of its kind and with this scientific extent on cultural and architectural heritage in Morocco. Moreover, finding an extension of academic research in the dissemination, the bringing back and mediation on this monument that stands for a symbol and emblem of Morocco's capital, is a direct valorization of research work performed in Moroccan research laboratories. This paper presents representative results of the whole project, including its historical and arts history, especially on Rabat Hassan Mosque. We are providing, for the first time, results that make possible 3D display of what Hassan Mosque might look like. This model with the vocation to be a scientific support and medium and to which we attempted to bring all the necessary rigor. This will serve the scientific study of the monument, the popularization and awareness raising with respect to cultural heritage matters in general and Hassan Mosque in particular.

We hope, therefore, to remain faithful to one of the wishes of Professor Driss Aboutajdine,

which is to ensure that scientific research directly impact the society.

Key words : Hassan mosque, 3D modeling, reconstruction, digital heritage.

1. Digital Heritage issues

Architectural cultural heritage includes all evidence of human creativity and expression from the past. It is considered as a bridge between the past and the future. Exactly for this reason it is very important to preserve it. Besides Architectural cultural heritage contributes to the reinforcement and promotion of tourism and thus to economic development. In fact, this heritage is an important asset for the development and promotion of cultural tourism ; but it is also the witness of civilization over time. Morocco has a rich and diversified architectural and urban heritage, including buildings of different ages and architectural styles. In addition, it has an archaeological heritage of no less importance, made up of traces of ancient cultures and ancient civilizations several thousand years old ; a heritage to be proud of. The valorization of this history involves the preservation of this heritage through its inventory, its restoration and its conservation. These days, one way to achieve these objectives is a digitalization. Indeed, digital transformation is now a very interesting paradigm that complements and renews traditional means of safeguarding and mediation. The digitization techniques we have at present enable us to perpetuate the architectural cultural heritage to infinity in virtual form. Thus, 3D modeling makes restitutions, backup, reconstructions and studies possible either for better restoration or simply in order to better understand and thus better explain. See for examples works done in research program E-Cathedrale ([1]) and in [2]. During the last decade, automatic 3D modeling has made a significant progress thanks to, on the one hand, the emergence of a wide range of high performance laser scanners and affordable cost, on the other hand, the "go back" to photogrammetry which, thanks to algorithmic advances (Sift, Semi Global Matching ...) and the explosion of digital photography, has become a reliable and automatic modeling method in many contexts. In the aim to preserve the Moroccan architectural cultural heritage we proposed a research project called "Athar-3D project" (for 3D historical trace/footprint). This project is a marriage between 3D digital culture and architectural heritage. It meets both the needs of the general public for the varied uses of discovery and knowledge of heritage, as well as the demands of professionals and researchers for uses such as knowledge and scientific research, education and tourism. The 3D architectural heritage modeling has many challenges : the diversity of surfaces and objects requires the use of different forms for digitization, management of data heterogeneity, data size, scale and accessibility for digitization. In the effort to face these challenges, our contributions can be summarized as follows : study of a system for digitizing difficult-to-access objects and surfaces using a catadioptric approach for dense stereo vision, study of the fusion of laser scanners data and photogrammetry 3D point clouds, digitization of the Hassan mosque and multidisciplinary study on the contributions of the 3D model to

the study of the Hassan mosque in Rabat. The Athar-3D project is supported by a bilateral Franco-Moroccan scientific cooperation program that is the Hubert Curien Partnership (PHC)¹ "Toubkal". It is carried out jointly by the Laboratory of Research in Computer Science and Telecommunications (LRIT- Laboratoire de Recherche en Informatique et Télécommunications) on the Moroccan side, and the Laboratory of Modeling, Information and Systems (MIS - Modélisation, Information et Systèmes) on the French side. In addition, several experts from the National Institute of Posts and Telecommunications (INPT), the Higher National School of Computer Science and Systems Analysis (ENSIAS-Mohammed V University in Rabat), and the Agronomic and Veterinary Institute Hassan II (IAV Hassan II), have been involved in this research project to validate the scientific part or the historical part. In addition, Ms. Mina El Mghari, art historian and professor at Mohammed V University in Rabat, is associated with the project to bring the skills of history and art history to the project. In this article, we try to present the preliminary results of this multidisciplinary collaboration which completes and renews some knowledge about the Hassan mosque. Hence, we will present the tools of digitization, the results obtained and the reflections resulting from the interactions between the digital model and the history of art. We also hope that this work, which is only at the beginning, will increase the interest for the Hassan mosque in particular and for the architectural heritage in general.

2. Digitization and reconstruction : background and tools

The need of professionals for 3D representation techniques as valuable source of detailed information has made of photogrammetry and lasergrammetry two attractive techniques. Regarding architectural applications, although lasergrammetry may seem to offer a better compromise between accuracy, speed of data acquisition, photogrammetry presents in many cases an interesting alternative to laser scanning surveys especially for outdoor modeling when it can be combined with UAV.

2.1. Digitization by photogrammetry

In the past, photogrammetry was based on sophisticated optical-mechanical equipment that limited its use due the high cost of this equipment and the need for well-trained personnel. The technological advances that affected photogrammetry lately and the bringing closer to computer vision have increased the interest and the use of photogrammetry in a variety of domains for automatic 3D modeling from multi-station photos. Nowadays, both the acquisition of photos and their processing are much flexible and within the reach of non-photogrammetrists provided the correct procedures are followed. Although the quality of the image is crucial, simple on the self-cameras can be used in either modes : static mode (terrestrial stations) or dynamic mode (van, uav,).

1. <https://www.phc-france-maghreb.org/>

Once the photos are acquired, the general processing workflow goes through 3 sequential steps : first, the key points (or point of interest) are detected on overlapping photos having common coverage of the scene, second the relative orientation and bundle adjustment are done simultaneously and the last step is the generation of a dense points cloud by automatic correlation. Concerning the detection of key points or points of interest, many algorithms were developed in photogrammetry and computer vision, starting by a research done Hans Moravec back in 1981 and improved by others (Harris, Schmidt, Mohr, Forstner). The mostly used today in many software is the concept of Scale Invariant Feature Transform (SIFT) developed by Lowe. The concept transforms an image into a large collection of feature vectors, each of which is invariant to image translation, scaling, and rotation, partially invariant to illumination changes. SIFT operates in two main steps : a first algorithm detects the points of interest and a second algorithm is used for the matching.

Approaches using SFM (Structure from Motion) method, can simultaneously determine camera calibration, and camera position and orientation relative to the photographed object, for each photo. This is done by iteratively refining the intersection between bundles corresponding to homologous point. A 3D model of high level of details is then constructed by densifying the previous point cloud. The reconstructed 3D models can be rendered with realistic texture. One can also mesh the point cloud for subsequent advanced modeling and manipulation. Other products such orthophotos, vectors representing different structures of the object may be generated equally in an easy manner.

The process to produce this 3D model by Computer Vision community is now very well known. One can find easily toolboxes and software to realize automatically all needed processing to produce these models. In our case, we used MicMac²[9] which is a free software produced by the IGN (partner of the consortium of Athar-3D project).

2.2. Digitization by laser scanner

With the increase of public awareness for the preservation of cultural heritage, the need is becoming important for new possibilities and ways to survey and document monuments and architectural and archeological sites for the analysis, modeling, reconstruction and communication on cultural heritage. Photogrammetry, close range mainly, has, for a long time, being used to provide accurate 2D and 3D data through the processing of stereo photos.

Late advances in the electronic domain and the emerging of laser scanning technology have opened new possibilities for professionals in charge of architectural documentation using laser. Hence, terrestrial laser scanner are nowadays widely used as they proved to be a valuable technology for the surveying of complex surfaces in a lesser time, accurately and with less effort.

In laser scanners, a laser beam is emitted from a laser light source and used to scan the surface of objects of interest. The laser beams has the ability to be oriented into varying directions by a system of mirrors combined with an instrument rotation.

2. <http://micmac.ensg.eu/>

Data acquired by the scanners consist in either Cartesian (XYZ) or polar coordinates (vertical and horizontal angle) augmented with information on the intensity (reflectance) of the received signal.

The data describing the detected 3D point cloud in space, can be visualized in 2D-image. In order to generate a 3D model of the object scanned, the scanner is generally placed in different stations in order to cover the entire object. The individual point clouds acquired from these stations should be registered in order to merge them to constitute the entire 3D model either in a local or global coordinate system. The software based on targets usually accomplishes this registration automatically. These targets are placed before scanning and shared by the clouds; in order the software can recognize them automatically later.

The quality of the cloud will depend on the accuracy of range determination, the size of the spot and the resolution and angular accuracy of the scanner. A camera may capture along with the scan photos to be used for the texturing of the 3D model when needed. But, the quality could be improved by using others images [3].

2.3. 3D modeling process

We will focus on Blender, but this process can be achieved using any other 3D creation software. Blender is a professional free and open-source 3D computer graphics software proposed to create 3D visualizations such as images, videos, and real-time interactive video games. The advantage of the 3D software like Blender is that it can be used in all stages of any architecture project. Blender is not the fastest tool in architecture but it is flexible when creating custom 3D shapes. The 3D reconstruction of any object of the mosque with Blender requires to identify the shape of the object, in the images of the book, and to measure the right dimensions on the plans. Blender tools allow manipulating simple geometrical shapes (circle, cylinder, sphere, ...) and to modify them according to the information provided by the images of the book and the plans. Blender's features include 3D modeling, UV unwrapping, texturing, sculpting and animating. Blender Modifiers are tools of 3D modeling that allow automatic operations that affect an object in a non-destructive way. They work by changing how an object is displayed and rendered, but not the geometry which remains stored in computer memory. The Modifier Stack is used in case where several modifiers are added to a single object.

The process of creation of 3D model of each object in Blender is unique. However, many components of the mosque, such as arches, require the same steps during their creation. To illustrate this we give the example of the arches modeling. The general process of modeling arches is a Blender Modifier Stack. The four steps of this process (Fig. 1) are states of the arch during its creation and the links between them are Blender modifiers operations. The first step of the process is to create the 2D shape of the arch from its image. The second step is to generate a 3D object with the extrude tool and then correct it with Blender modifiers: Recalculate, Smooth and EdgeSplit to get the final 3D shape of the arch at the last step of the process.

The 3D Textured Mesh reconstruction from point cloud [5] is a process based on surface

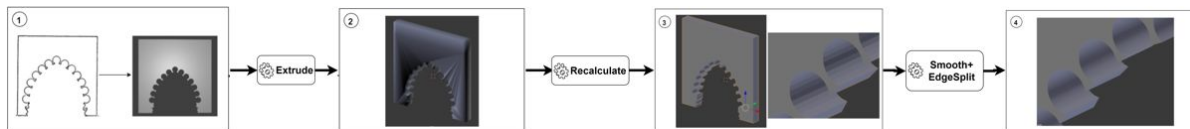

FIGURE 1 – General modeling process for Arches of Hassan mosque.

reconstruction algorithm that allows creating a 3D model from a point cloud. The importance of this method is to extract specifics elements of the point cloud like the pillars and then use them in the 3D reconstruction of the mosque. The algorithm described in [4] allows creating surface from oriented point sets.

The mesh is imported into Blender in PLY format (Polygon File format) and duplicated with Array modifier. Blender Cycle Render engine is used to detect the colors of the mesh vertices and to render the scene.

3. Toward a digital model of Hassan mosque

Our aim goal is to propose a 3D model of this mosque. We will proceed in two steps. The first one consists to digitize the existing part of this monument. This partial model will be used to have accurate measurements, textures and will serve as a digital copy of the existing part of the mosque. In the second step, we will complete the model by using the technics presented in section 3.2 and the reconstitution proposed in [7].

3.1. Hassan mosque

Hassan Mosque (Fig. 2) is an exceptional monument of Rabat city, which was built on a princely order. This huge project is the witness of a Moroccan architectural art that never ceased to evolve along the ruling of Almohade dynasty (1147-1269). This fine architectural grouping is an evidence of talented city planners, engineers, architects and great visual artists of Almohade epoch. Hassan Mosque is laying his vestiges within an area of the city called after him situated in the North East par of Rabat city. The monument is at Mohamed V Musoleum's feet, another masterly and modern architectural grouping. The Mosque was admittedly founded by the caliph Abu Yusuf Ya'qub Al-Mansour (1184-1199) in 599/1196 ; however, historical and archeological signs of evidence bring the monument to the father of Al Mansour Abu Yacoub Youssef. As for Rabat (Ribat Al Fath), the construction of Hassan Mosque is the outcome of the dynasty policy or Jihad (holy war). In fact, the Jihad was the main reason behind Almohades establishing new Ribat cities. Rabat city is one of the major examples in this respect. Rabat City was conceived in Alexandria's image and endowed with Hassan Mosque, the tower of which dominates maritime entrance from the top of its 86 meters height. Many historical and archeological researches were devoted to Hassan

Mosque vestiges. Since the beginning of the last century, amateurs and professionals were attracted by the site. In fact, the first surveys were launched in 1902. These were followed by series of excavations and prospecting, in 1913-1914 (Dieulafoy) [6] and 1933-1934 (Jules Borely). Investigations and topographic surveys, spread up to the foundations, undertaken by Historical Monuments Inspection in 1934-1944 (under the direction of H. Terrasse) revealed that the construction work was interrupted in 1199 following Al Mansour death. The different studies were crowned in 1949 by the work of Jacques Caillé and Jean Hainault [7]. Fig. 2 shows old and recent photographie of the esplanade. Fig. 3 shows a plan of global mosque as proposed by [7]. In red color, we added the actual remains of the esplanade.

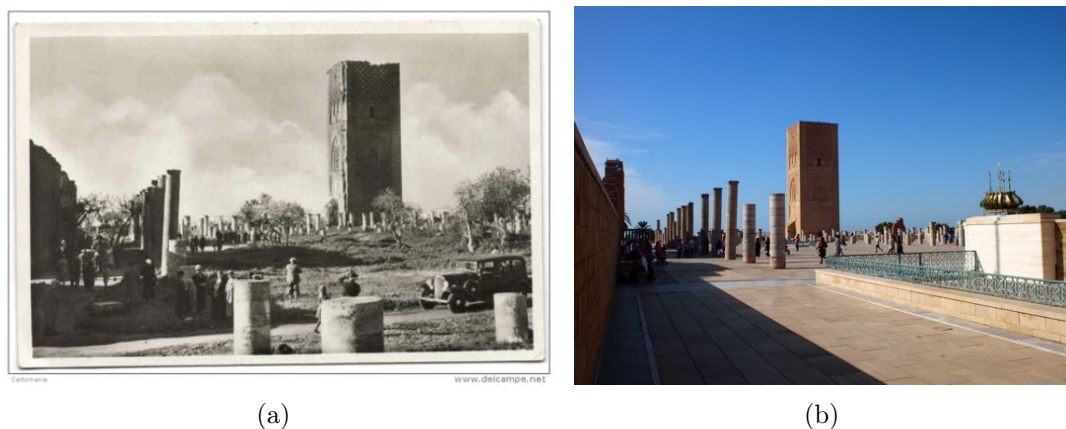

FIGURE 2 – Photos of the Hassan Mosque. (a) Old photo (before restoration)(<https://www.delcampe.net/>). (b) Recent photo (2017).

3.2. Results of digitization

We realized the digitization of the esplanade Hassan in june 2015 (from june 8 to 12) by using lasergrammetry and photogrammetry. Unfortunately, at the same time, the tower was under renovation and the scaffolding obstructed its digitization. Therefore, it was not possible to scan the tower accurately (as we can see in the results sections) neither outside nor inside. The lasergrammetry was done with Leica C10 scanner³. We made 25 scans on the entire esplanade to cover all the columns. Fig. 4 shows captions from the 3D model. Fig. 5 shows some results from the photogrammetry, with camera poses. Red color is the frontal side of the camera when the green color mention the rest of the camera. The results of the photogrammetry have used for the texture of pillar, wall and the outside of walls.

These 3D models can serve for measurements, accurate plans, extraction of exact shapes and also as a didactic support to explain the history of the architecture of this mosque.

3. by help of GLOBETUDES Sarl company.

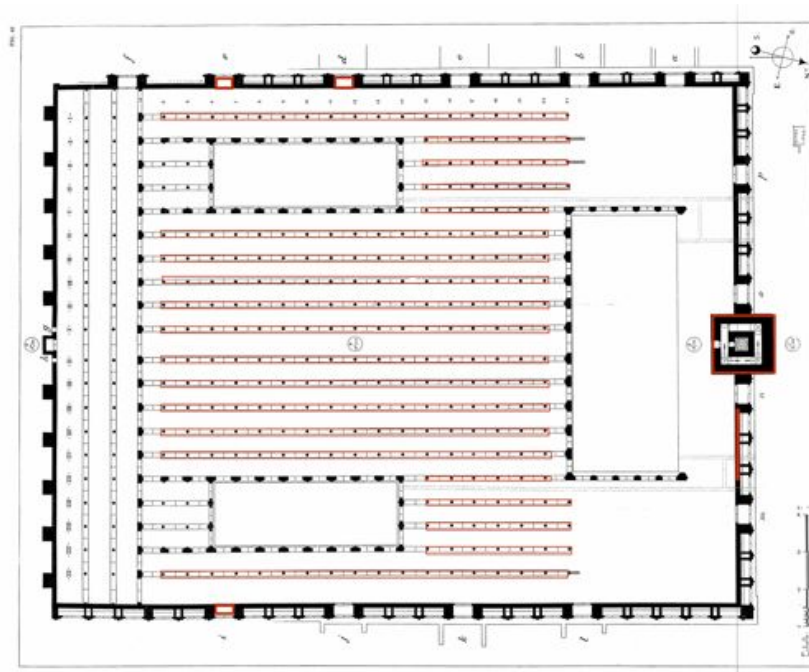

FIGURE 3 – Comparison between plan designed in [7] and the actual state on the esplanade. Red color indicates the common parts.

3.3. 3D reconstruction

In order to achieve the 3D reconstruction, we analyzed plans and descriptions of the mosque presented in [7] which is the most complete and up-to-date document written about this mosque. Fig. 6 shows two examples. These documents allowed us to realize a 3D model representing the missing parts of the Hassan mosque in Rabat.

The 3D digitization methods presented in Sec. 2.1 and 2.2, have been used to obtain the exact geometry, texture and color for the existing parts of the mosque. For the inexistent parts (arches and tiles), we have used historical sources, archives and archaeological excavations [7]. In the next we will give the results of the 3D reconstruction of five parts of the mosque.

- **Pillar model** : There are two types of pillar : the smallest pillar is used in the oratory hall except for the extreme aisles where the second type is used. We used the sizes given by the lasergrammetry. The texture has been obtained by the photogrammetry 3D model (Fig. 5) because the quality of images given by the internal camera of the scanner is not sufficient.
- **Arches model** : Many are smooth arches, which divide the aisles of the mosque between them and unite the oratory hall to the lateral gallery. However, there are also three kinds of lobed arches : arches with equal lobes, trefoil lobes or stalactites which emphasizes the importance of the central and extreme aisles. Fig. 7(a) shows

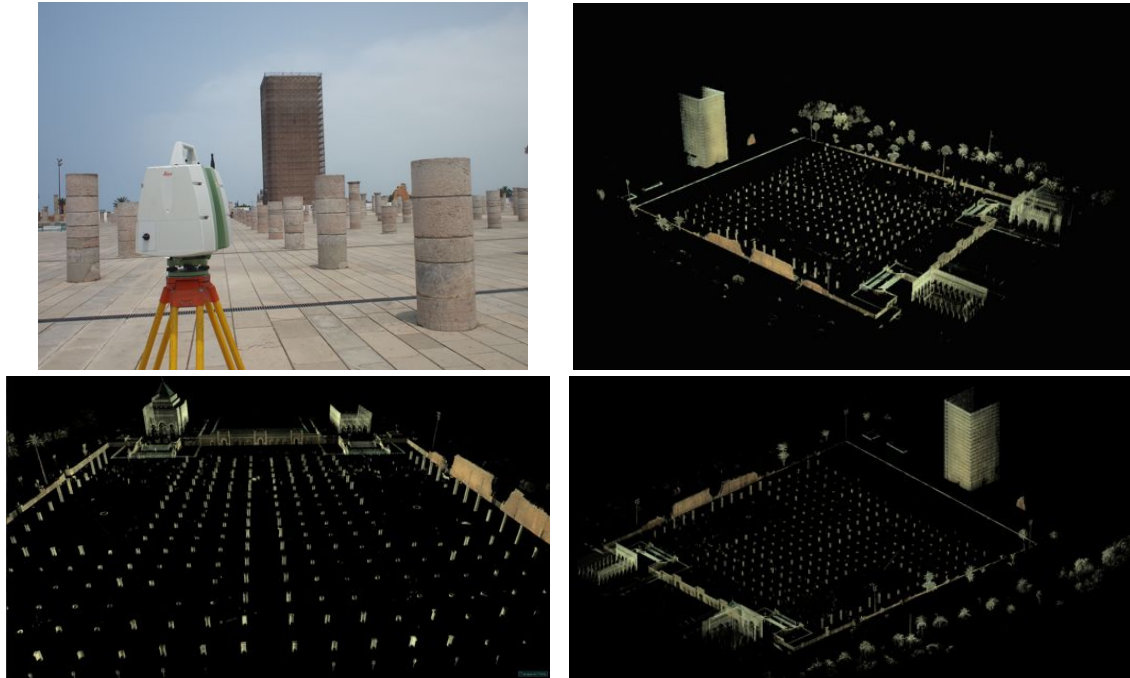

FIGURE 4 – View of the esplanade with the used scanner and captions from the 3D model got by lasergrammetry.

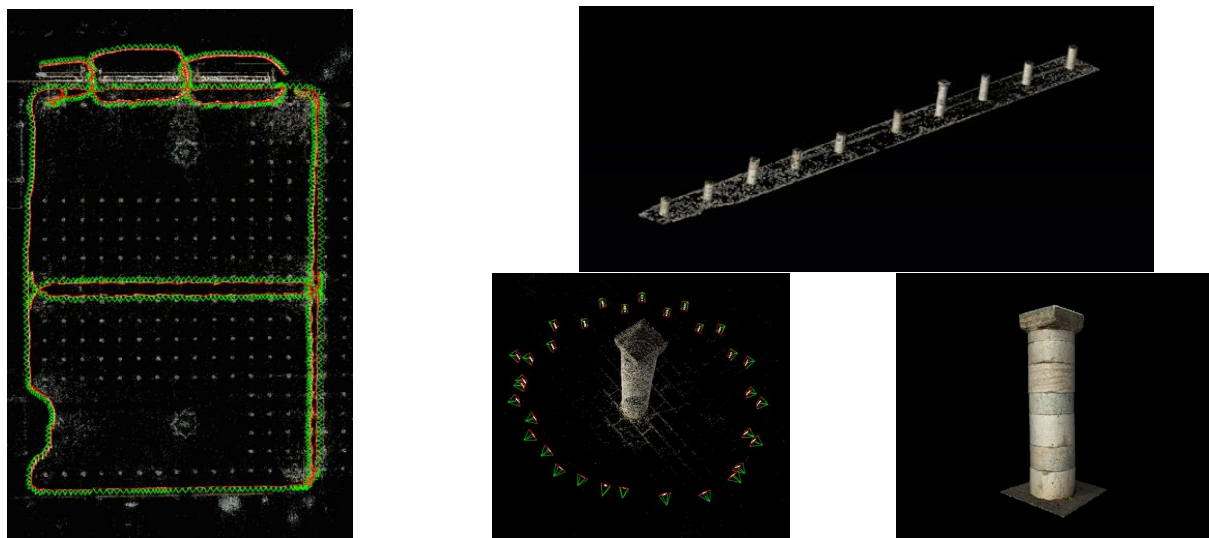

FIGURE 5 – (a) Global model and camera poses (green and red for frontal face), (b) Pillar and camera poses, (c) Dense 3D model for this pillar, (d) Row of pilars.

the restitution of the arches as they are on the plans of the mosque and Fig. 7(b,c,d) illustrates results of 3D reconstruction of all the existing arches in the mosque.

- **Outer wall :** The outer wall of the mosque is built by several basic elements that are modeled individually according to the dimensions expressed on the plans. The reconstruction process of the outer wall is composed of three steps that are :
 - Modeling the general form of the outer wall which surrounds the mosque. This step requires modeling stairs and all arches that represent the entries of the mosque.
 - Adding the decorative elements to the wall. There are two types of decorative elements on the plans : tiles and geometric form that are found above the wall and the minaret as well.
 - Adding texture to the wall. This texture is created after 3D mesh reconstruction process of the cloud of the wall. The textured mesh of the wall is then added to the 3D model of the second phase to obtain the final model of the outer wall.
 The same process was applied to the whole wall and the final result is shows in the Fig. 9.
- **Tile model :** The 3D modeling of the tile is based essentially on a single image given by [7] (see Fig. 10). The 3D model of tile is quite simple, but it is necessary to cover all the roofs and the outer wall of the mosque with thousands of tiles. This increase the rendering time of the final 3D model of the mosque. In order to reduce the amount of rendering time, we made sure we had as few vertices as possible on the tile model. In addition, we used the Blender Decimate modifier to decrement the number of vertices in tile model shown in Fig. 10.
- **Roof model :** The roof is composed by two types of elements : the small element covers the simple aisles and the larger one covers the central and extreme aisles of the mosque. The 3D reconstruction of the roof is achieved manually by duplicating the two above elements. The Fig. 10 shows the restitution of the roof.

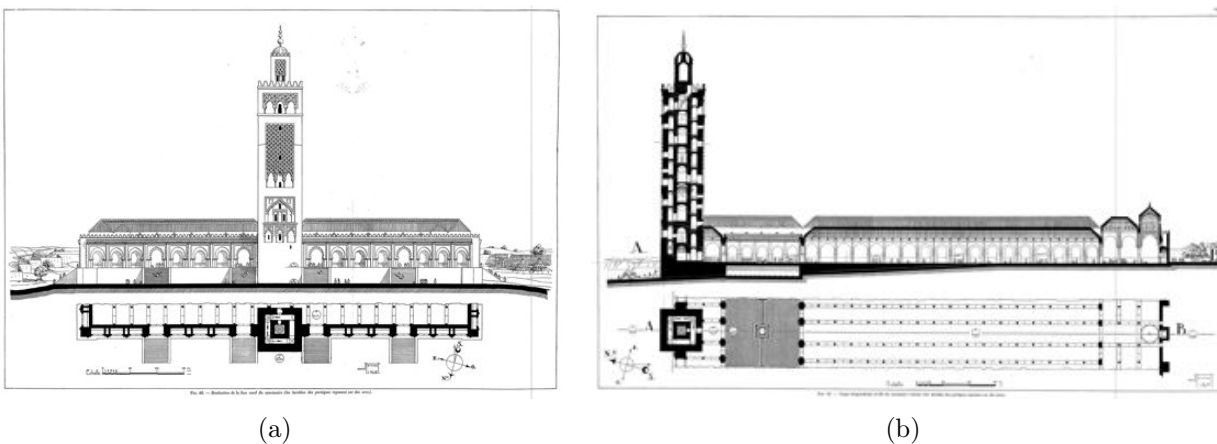

FIGURE 6 – Two examples of plans from [7] (see the electronic document for good quality).

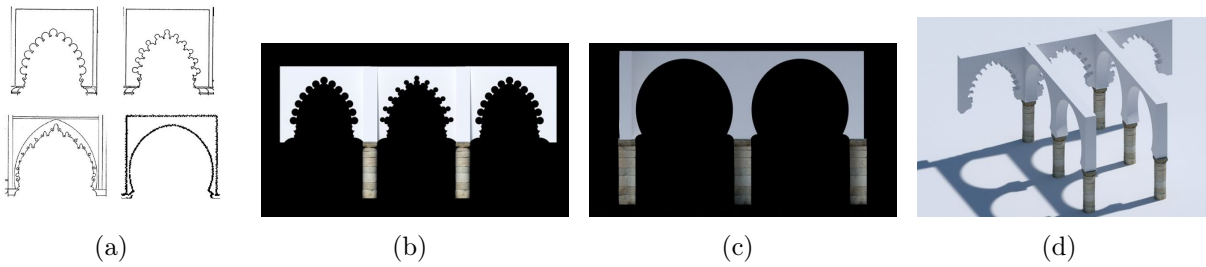

FIGURE 7 – (a) Restitution of the arches . (b) (c) (d) 3D reconstruction of all arches.



FIGURE 8 – (From left to right) Different steps of 3D reconstruction of outer wall.

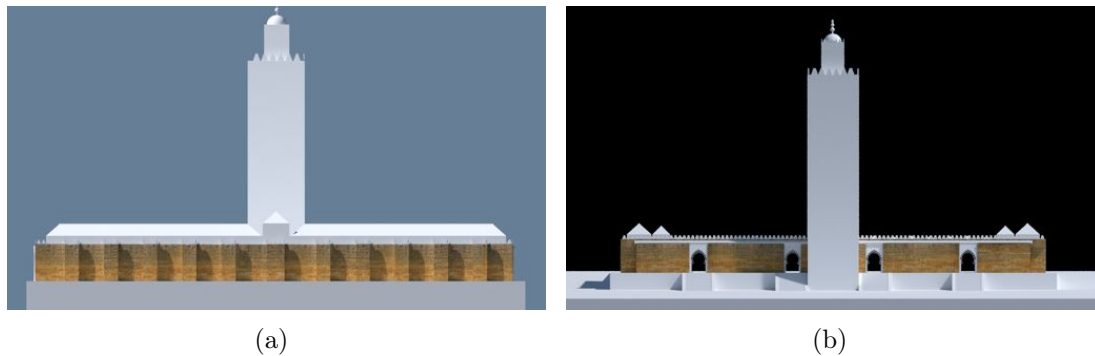

FIGURE 9 – Final 3D reconstruction of the outer wall.

The final model of the mosque includes all the parts mentioned above. The parts that appear several times in the plans are duplicated with the Blender Array modifier according to the distances in the plans. The parts that appear once as the minaret are added directly to the final model of the mosque. For example, to duplicate the arcs and the pillars we used several plans and especially the top view and cutplanes (Fig. 6) of the mosque from [7]. Fig. 11 shows the top view and the same view in final 3D reconstruction of the mosque.

Fig. 12 gives a view without the roof in order to show the global structure of the mosque and a global perspective view.

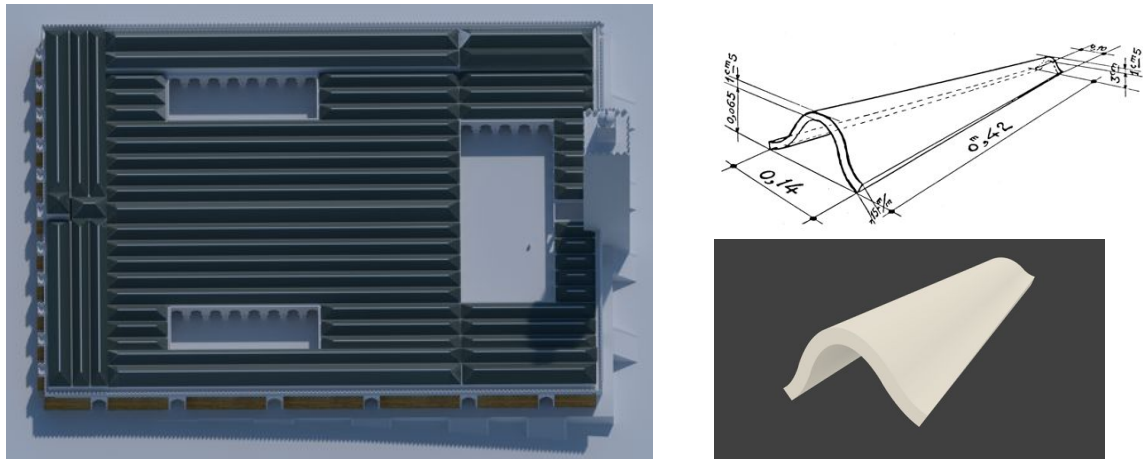

FIGURE 10 – (a) 3D reconstruction of the roof. (b) Tile shape and dimension [7]. (c) 3D model sample of the tile.

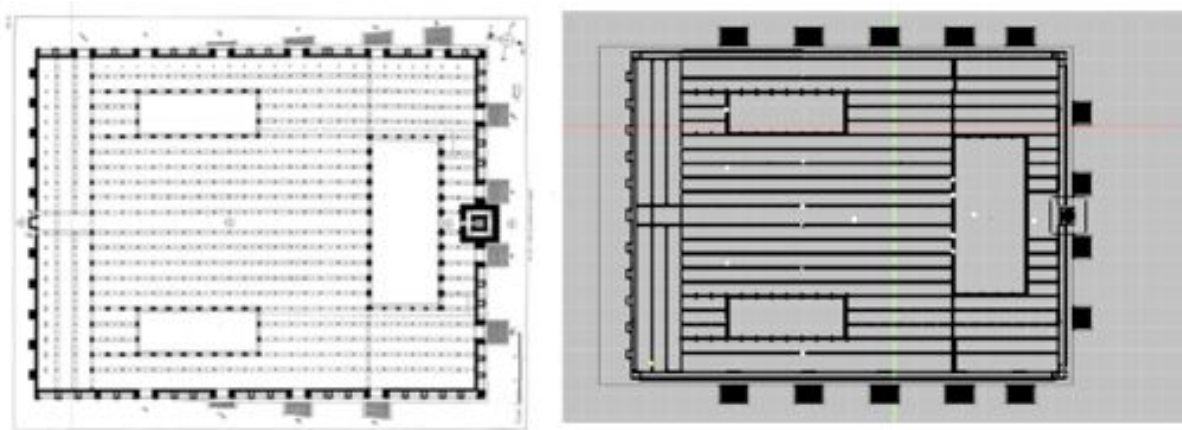

FIGURE 11 – At left plan of top view of the mosque[7]. At right top view of 3d reconstruction of the mosque.

4. Complete 3D model and comments on the architecture of the Hassan mosque

Hassan Mosque stands for a very moving monument due to its proportions and perfect design as we can see in Fig. 11 and Fig. 12 for a view with and without roof. The mosque was conceived to be the vastest worship space of the whole western medieval Muslim community and the most outstanding monument of Almohade dynasty. It covers an area of 25551 square meters, in a quadrilateral shape 185 meters long and 140 meters width and surrounded with a wall in Tabya (pisé). The enclosure is punctuated with square bastions giving to it a military

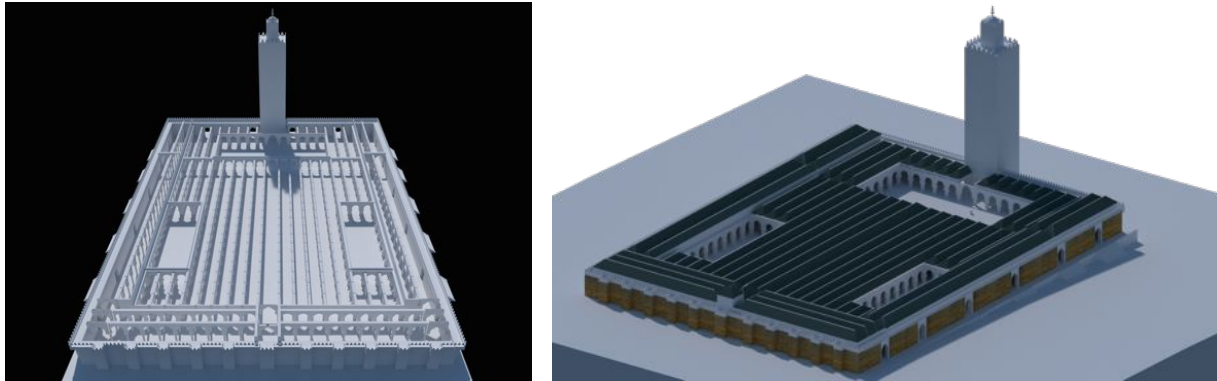

FIGURE 12 – Views of the final 3d reconstitution of the Hassan mosque in Rabat.

appearance; a new trend adopted by Almohades for worship spaces to symbolize their faith as well as their power. Many gates give access to the huge building : six of them are on the south-west side. The Northeast and North-West sides are open via four bays each Fig. 11. Salient canopies top these doors. These are allowing access to a large prayer hall almost square shaped. The naves are marked off by lined up rows of columns compound of cylindrical drums. The naves are perpendicular to the Qibla wall. These are set up in odd number on either side of a wider and taller axial nave. The intersection of this and the transept nave (the qibla nave) having the same dimensions, delimit a square area that receives a dome, the principal function of which is to enhance the Mihrab alcove (believers commander place), as it is usual in earlier Oyemade's, Aghlabids' and Almoravides Mosques. In this vast prayer hall, one can distinguish two specific areas : the first running along the qibla wall, which counts three parallel naves, and the second, more spacious, made of twenty-one naves perpendicular to those of the first area. The median naves, those of the qibla and those that are lateral are the same width. The first naves create the plane in **T**, the others lead to the plane **U**. To assure good airing and enough lighting to the monument grouping, Hassan Mosque is equipped on both sides of the longitudinal axis of two secondary courtyard barlongue shaped Fig.12. This plane with perfect symmetry where « shows a perfect predilection to the square is an unusual fact ([8], p. 207). However, to be different from their predecessors, Almohade master-builders introduced some innovations. The first innovation in the increasing number of domes in the transept nave that is competing with the axial nave. The two lateral naves of prayer halls are enlarged to obtain the same width as that of the transept nave and hence to keep, in both ends of this, two squared areas bearing two new domes like in Taza and Tinnel grand mosques. Besides this disposal, Hassan Mosque is made up of an uncovered courtyard : the Sahn (Fig. 12), bearing a rectangular shape (71, 50 meters of width and 27 meters in depth). This courtyard is organized in a perfect mouminide tradition reminding of Tinnel, Taza or Koutoubiya courtyard. Hassan mosque Sahn grows longer on both sides with two galleries in continuation of lateral naves of the oratory. In the center of north wall, there is a minaret/tower, reminding by its location, the minaret of Sidi Ukba Mosque in Kairouan. The

buttress towers of its southern façade testify the influence of Cordoue Mosque. The northern façade is composed of three superimposed naves; the first one spreads out a polyfoiled arc bordered with two arcs the springing of which are made of thin columns in white marble. The next alcove raises the first one, and shows a big arc holding tightly three polyfoiled arcs. The last register covers the truncated part of the façade. Three polyfoiled arcs are used on flat end on which rests an intertwine diamond shaped and curved darjel ktef. For a symmetry purpose, the same intertwine resting on the same type of arcs to fill out the upper register of the southern façade. The lower register of this is showing a worn out arc overstepping with smooth horses wrapped up by a large arc the extrados of which shows nine arcs with seven foils. The register axis is characterized by twin blind alcoves in form of pelmet arcs topped with a network of diamonds and two-headed curves. Eastern and western façades are reproducing almost the same composition. This is repeating a diamond frame in curved mesh supporting on either side three foil arcs similar to those already met on the same level of the northern façade.



FIGURE 13 – Longitudinal views.

5. Conclusion

In the aim to preserve the Moroccan architectural cultural heritage, we focus on the famous historical monument : the Hassan mosque. Our goal is to give the complete digital

3D model of what the Hassan mosque was supposed to be if its construction was finalized and remain intact. We have combined digitization techniques based photogrammetry and laser scanner to obtain the exact geometry, texture and color for the existent parts of the mosque. To complete the 3D model, we have used historical sources and archives to reconstruct the inexistent part of the mosque using Blender. We have succeeded restitution of five important parts of this huge mosque. This restitution is conforming to the plans given in [7] and allows to provide a realistic global structure of the mosque. Nevertheless, the obtained 3D model remains incomplete. We intend to explore other sources and archives in order to complete the restitution of the other inexistent parts of the Hassan mosque. On the another hand, we will develop some tools to allow the 3D navigation in this model.

The work whose premises have been presented in this paper, are intended to continue. We hope they will arouse a renewed interest in this monument.

Acknowledgements

The authors would like to thank the PhC Toubkal.

Références

- [1] <https://mis.u-picardie.fr/e-cathedrale/>.
- [2] K. Ait El Kadi. *Extraction des éléments des façades des bâtiments du patrimoine architectural à partir de données issues de scanner laser terrestre*. In PhD Thesis - Institut Agronomique et Vétérinaire Hassan II, 2016.
- [3] N. Crombez, G. Caron, E. Mouaddib. *3D point cloud model colorization by dense registration of digital images*. In 3D Virtual Reconstruction and Visualization of Complex Architectures, 3DARCH, ISPRS workshop, Feb 2015, Avila, Spain.
- [4] M. Kazhdan, H. Hoppe. *Screened poisson surface reconstruction*. In ACM Transactions on Graphics (TOG), 2013, vol. 32, no 3, p. 29.
- [5] <http://pointclouds.org/>
- [6] M. Dieulafoy. *La Mosquée d'Hassan*. Extrait Des mémoires de l'académie des inscriptions et belles-lettres, tome XLII, 1920.
- [7] J. Caille. *La Mosquée de Hassan à Rabat*. Publishing Editor, Number of Pages, Year of Publications.
- [8] G. Marcais. *Manuel d'art musulman. L'architecture*. 2 vol. Paris, 1926 et 1927.
- [9] E. Rupnik, M. Daakir, and M. Pierrot Deseilligny, *MicMac – a free, open-source solution for photogrammetry*, In Open Geospatial Data, Software and Standards, 2017.