



**HAL**  
open science

## Lack of correlation between the properties of a petroleum coke and its behaviour during combustion

Jean-Michel Commandre, Sylvain Salvador

► **To cite this version:**

Jean-Michel Commandre, Sylvain Salvador. Lack of correlation between the properties of a petroleum coke and its behaviour during combustion. *Fuel Processing Technology*, 2005, 86 (7), p. 795-808. 10.1016/j.fuproc.2004.08.001 . hal-01845780

**HAL Id: hal-01845780**

**<https://hal.science/hal-01845780v1>**

Submitted on 6 Nov 2018

**HAL** is a multi-disciplinary open access archive for the deposit and dissemination of scientific research documents, whether they are published or not. The documents may come from teaching and research institutions in France or abroad, or from public or private research centers.

L'archive ouverte pluridisciplinaire **HAL**, est destinée au dépôt et à la diffusion de documents scientifiques de niveau recherche, publiés ou non, émanant des établissements d'enseignement et de recherche français ou étrangers, des laboratoires publics ou privés.

# Lack of correlation between the properties of a petroleum coke and its behaviour during combustion

J.-M. Commandré\*, S. Salvador

*UMR CNRS 2392, Laboratoire de G'enie des Proce'd'es des Solides Divise's, Ecole des Mines d'Albi-Carmaux, Campus Jarlard, route de Teillet, 81013 Albi CT cedex 09, France*

## **Abstract**

This work is an attempt to establish links between the properties of the petcoke that can be measured through standard analysis in the laboratory and the behaviour of the petcoke both in terms of its combustion velocity and the emission of gas pollutants.

A large number of petcoke, 22, taken from different sources, were burnt in an Entrained Flow Reactor (EFR) in conditions close to those of a fluidised bed of a cement plant precalciner. The burnout for the 22 petcoke ranged from 68% to 81%. The gas emissions resulting from their combustion were analysed. Prior to this, each type of petcoke was characterised in terms of its chemical composition, volatile matter and ash content, structural properties and LCV. The correlation between all these characteristics and the combustion velocity, SO<sub>2</sub> emissions and NO emissions in the EFR were systematically investigated.

The combustion velocity does not appear to be correlated to any of the properties. The emissions of SO<sub>2</sub> can be accurately predicted from the content in S of the petcoke. The emissions in NO are not directly linked to the N content of the petcoke. No simple correlation could be established to predict NO emissions.

*Keywords:* Petcoke; NO emissions; SO<sub>2</sub> emissions

---

---

\* Corresponding author. Tel.: +33 5 63 49 31 27; fax: +33 5 63 49 32 43.  
*E-mail address:* commandr@enstima.fr (J.-M. Commandré).

## 1. Introduction

The refining of petroleum, during which the lighter fractions are extracted in the form of liquid or gaseous fuels, also results in a flux of heavy residue. This residue is called petroleum coke or petcoke. At ambient temperature, this fraction is solid and can be ground in traditional mills to obtain a powdered fuel that can be substituted for coal or other traditional fuels. Heavy industries such as cement plants can use these low-cost fuels whose LCV is high at 32,500–35,000 kJ/kg. Over the years, a number of difficulties have come to light in the use of such fuels.

Firstly, petcoke contains low quantities of volatile matters (VM). Consequently, most of the energy will be generated by the oxidation of the carbon residue, also called char, formed during the first step of the combustion process: devolatilisation. When coal is used, typically, 10–60% of the fuel mass is released during devolatilisation under the form of gasses (VM), and approximately, the same fraction of the energy production is due to the gas phase oxidation of the VM. These reactions are much quicker than the oxidation of the carbon residue, also called char. Petcoke contains only 5–16% of VM. Consequently, the residual amount of carbon in the ash can be very high at the exit of a furnace or kiln using petcoke.

Secondly, as is the case for coal, petcoke contains significant amounts of N and S. Their combustion causes the formation of gases containing nitrogen, particularly NO. The relative importance of fuel NO with regard to the thermal NO depends on the rate of fuel nitrogen, on the combustion temperature and on the equivalence ratio in the reactor [1]. In the conditions of the combustion performed in this work, which correspond to those encountered in a fluidised bed reactor or in a cement plant precalciner, only fuel NO is formed [1,2], i.e., NO resulting only from the oxidation of the N initially present in the fuel and not from the oxidation of N<sub>2</sub> present in the air. The sulphur initially present in the petcoke will cause the formation of S-containing gas species, of which SO<sub>2</sub> is the most prevalent [3,4]. The presence of S-species in the gas phase has an effect on the level of NO concentration emitted at the end of the reactor [5–10].

In the past, the use of petcoke in large-scale boilers and furnaces has clearly established that the behaviour of a petcoke can be drastically different from one petcoke to another both in terms of the combustion velocity and of pollutant emissions. Very little literature has been devoted to these fuels, making it difficult to interpret the differences observed in the behaviour of cokes from different sources. The cost of petcoke has fallen to virtually zero, but at the same time, the quality has declined. In particular, sulphur contents have generally risen, and the mineral matter content has also increased.

Developing a tool to predict the behaviour of a petcoke is of course very attractive: this would enable petcoke to be selected that will not produce high amounts of residual carbon in ash and that will keep environmental pollution to a minimum. Inasmuch as these fuels are usually bought in large quantities (several tens of thousands tons of fuel carried by ship), the rewards for developing such a product may be considerable.

This work, carried out over a period of more than 6 years, was devoted to this purpose. As a first step, we characterised a large number of petcoke coming from different origins in terms of all standard laboratory analysis: ultimate analysis, proximate analysis, structural properties, LCV, water content. We then performed combustion of the petcoke

using an Entrained Flow Reactor, sometimes also called a Drop tube furnace, which we developed specifically for this work. The temperature was 900 °C, and the gas residence time was 2.13 s. The gas emissions resulting from petcoke combustion were quantified at the exit of the combustion process. We then systematically searched for any correlation that could be established between the properties of the petcoke and its behaviour during combustion. The combustion velocity was quantified through the amount of oxygen that was consumed. The gas species NO and SO<sub>2</sub> were also quantified. The emissions of CO, CO<sub>2</sub> and hydrocarbons (HC) were analysed to see if information about their concentration would facilitate the understanding of the combustion and pollutant formation process. All the details of the procedure developed and the results obtained in this first step are described in this paper.

In parallel, but here termed as a second step, important work was carried out to identify and to characterise the physicochemical phenomena involved in the combustion process and in gas phase pollutant formation. This work, which has already been published [11–13], will be recalled here and will provide a number of key elements in interpreting and explaining results obtained in the search for correlation between the properties of the petcoke and their behaviour during combustion.

## 2. Properties of the petcoke

Twenty-two petroleum cokes were used in this study. They were sampled at different industrial sites, dried, ground in the laboratory and pneumatically sieved to select the 30–100 µm fraction for each fuel. This calibration meant that the particle size distribution for all the petcoke that were burned was very similar. As a result, this parameter will not affect combustion behaviour in our experiments.

Ultimate and proximate analysis was carried out, and results are given in Table 1. The BET surface area and the LCV were also quantified. The 22 petcoke exhibit very similar compositions in terms of the major species: the content in C ranges between 81% and 89%. The volatile matter content ranges between 5% and 16%, which is low when compared with coals, which typically exhibit percentages of 10–60%. The ash contents are also low, inasmuch as all the petcoke contain less than 6% of ash (most of the time around 1%), one of them containing 0.12%.

The amounts of N are comparable with those of coal; they range between 1.21% and 3.5%, most of the values being lower than 2%. It has been demonstrated in previous works [3,14] that the NO formed during the combustion of powdered fuels in fluidised bed conditions is fuel NO, i.e., NO formed by the oxidation of N in the fuel and not by the oxidation of N<sub>2</sub> present in the air. If all the N of the fuels studied here were converted into NO, the concentration in the flue gas would range between 2317 and 6613 ppm at 3% O<sub>2</sub>.

The sulphur content of the petcoke is significantly higher than that usually present in coal. The values range between 2.5% and 7.5% of S. A full conversion of S into SO<sub>2</sub>, which is known as the very dominant sulphur species after combustion, would range from 2007 to 6400 ppm at 3% O<sub>2</sub> for the present petcoke.

In terms of the heat released by the combustion of the petcoke, the values of the HCV indicated in Table 1 vary by 8.2% around an average value of 34,762 kJ/kg.

Table 1  
Ultimate analysis, proximate analysis and lower calorific value of the 22 petcoke

	Ultimate analysis					Proximate analysis		LCV J/g	BET m <sup>2</sup> /g
	C %	H %	O %	S %	N %	VM %	Ash %		
Coke 1	81.2	3.3		5.97	1.8	11.43	5.88	32,950	3.95
Coke 2	87.85	3.51	1.1	7.47	1.61	10.48	0.33	34,450	4.5
Coke 3	87.95	3.71	0.9	7.23	1.51	9.95	0.36	34,400	4.3
Coke 4	87.9	3.51	1.1	7.08	1.51	10.09	0.38	34,350	10
Coke 5	87.05	3.89	2.43	4.05	2.03	12.63	1.25	34,500	7.2
Coke 6	83.96	3.6	1.72	7.14	1.21	10.91	0.91	34,400	6.3
Coke 7	83.39	3.89	3.11	6.62	1.31	14.47	0.44	33,400	5.5
Coke 8	87.65	4.16	1.52	4.67	1.52	11.97	1.4	34,900	4.7
Coke 9	86.69	3.66	1.53	4.37	1.42	9.69	1.75	34,050	8.4
Coke 10	82.18	3.75	2.02	5.89	1.32	8.99	1.22	34,300	3.6
Coke 11	86.69	3.46	1.88	6.51	1.42	9.41	1.64	34,050	5.3
Coke 12	85.5	3.79		4.6	1.46	12.86	1.52	34,300	5.4
Coke 13	89.4	3.6		4.02	1.88	10.14	0.47	34,500	5.3
Coke 14	88.4	3.7		6.16	1.56	10.96	0.12	34,350	6.2
Coke 15	88.5	1.94		6	1.63	5.17	0.5	32,500	6.3
Coke 16	88.5	3.6		5.33	1.41	10.01	0.99	34,200	5
Coke 17	85.8	3.5		5.85	1.7	11.09	3.35	33,400	4.8
Coke 18	87	3.6		5.67	1.7	10.2	0.47	34,250	5.7
Coke 19	86	4.2		3.8	1.9	10.37	0.5	34,000	4.7
Coke 20	87.4	4.2		4.92	2.4	10.8	0.34	34,400	4.8
Coke 21	85.6	3.8		4.96	3.5	16.1	1.9	33,650	
Coke 22	88.3	3.8		2.5	3.4	14.4	0.5	34,500	

Ultimate and proximate analysis are measured on dry basis. The BET specific areas are those of the chars.

The reactive surface is known to be an important parameter in the combustion of porous solid fuels. Most of the models used today to describe the combustion of a char residue, representing here 82.0–94.3% of the initial mass, assume that the mass loss rate is proportional to that surface [15]. Although the reactive surfaces are not always measured in a consistent manner [15,16], one of the standard ways to estimate this surface is by BET measurement. We used this technique to quantify the specific surface of the char residues after soak pyrolysis, with N<sub>2</sub> as the absorbed gas at 77 K; the results are reported in Table 1. The specific surfaces exhibited are very small; they range between 3.95 and 8.40 m<sup>2</sup>/g, when coals typically present surfaces between 10 and several hundreds of m<sup>2</sup>/g [15,17].

### 3. Experimental device

We carried out the combustion of the 22 petcoke in a device specifically set up to achieve the combustion of pulverised solid fuels under “flash” conditions, typical of those in a fluidised bed or in a cement plant precalciner. The apparatus consisted of an Entrained Flow Reactor (EFR) whose design details have been described before [18]. The apparatus is shown in Fig. 1. It is an 80-mm i.d. 1-m long isothermal quartz reactor fed with an electrically preheated laminar atmosphere gas flow. The powdered solid fuel is

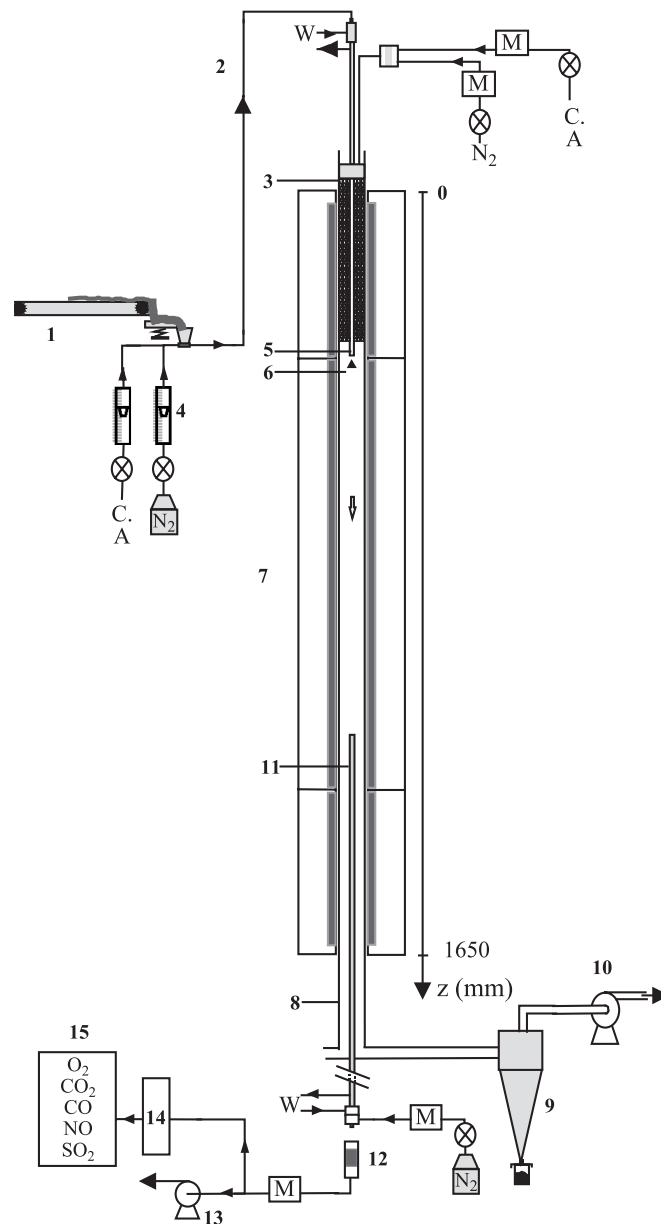

Fig. 1. Entrained Flow Reactor. (1) Conveyor belt/vibrating corridor/ejector; (2) pneumatic transport; (3) electrical preheater; (4) flow meters; (5) water-cooled feeding probe; (6) dispersion dome; (7) three-zone electrical furnace; (8) 80-mm i.d quartz tube reactor; (9) cyclone collector; (10) exhaust fan; (11) water-cooled nitrogen-quenched sampling probe; (12) particle collector (filter); (13) sampling pump; (14) gas conditioner; (15) gas analysers (infrared/paramagnetic); M—mass flow meters and controllers; N<sub>2</sub>—nitrogen; C.A—compressed Air; W—water (probes cooling).

injected through a water-cooled feeding probe and dispersed on the cross-section of the reactor. It burns for a controlled residence time (typically several seconds) before being sampled by a water-cooled nitrogen-quenched probe.

A specific device was set up to continuously quantify CO, CO<sub>2</sub>, NO<sub>x</sub> (NO+ NO<sub>2</sub>) and SO<sub>2</sub> through nondispersive IR absorption and O<sub>2</sub> through paramagnetic analysis.

During our experiments, the atmosphere gas and the reactor walls were heated to 900 °C. Measurements of the gas phase temperature inside the reactor during the combustion of petcoke indicated higher temperatures in the first third of the reactor but not exceeding 930 °C. The atmosphere gas was air, fed at a flow rate of 18 l/min at STP. The petcoke flow rate was 1.5 g/min; in these conditions, the equivalence ratio was 0.8. The sampling probe was placed 900 mm downstream of the feeding probe; the resulting gas residence time was 2.13 s. The difference between these experiments and the conditions found in an industrial boiler or furnace is that the flow was laminar in the EFR when it is usually turbulent on a large scale. Nevertheless, the temperature levels and chemical composition of the flow were similar in the EFR to those in an industrial application.

#### 4. Results and discussion

The solid fuel was injected continuously until a stable regime was reached; this was indicated by stable values for the gas species concentrations at the sampling point. The results obtained are reported in Table 2. In this table, the O<sub>2</sub> concentration has been

Table 2

O<sub>2</sub> consumed (O<sub>2</sub>cons), CO, CO<sub>2</sub>, SO<sub>2</sub>, NO, methanic and nonmethanic hydrocarbons (HC<sub>m</sub> and HC<sub>nm</sub>), total hydrocarbons (HC<sub>t</sub>) measured after combustion of petcoke in the EFR (900 °C, 2.13 s, equivalence ratio (0.8); (1)—gases concentrations converted at 3% O<sub>2</sub>, in daf (dry ash-free basis)

	O <sub>2</sub> cons (%) daf	CO (ppm) <sup>(1)</sup>	CO <sub>2</sub> (%) <sup>(1)</sup>	SO <sub>2</sub> (ppm) <sup>(1)</sup>	NO (ppm) <sup>(1)</sup>	HC <sub>nm</sub> (ppm) <sup>(1)</sup>	HC <sub>m</sub> (ppm) <sup>(1)</sup>	HC <sub>t</sub> (ppm) <sup>(1)</sup>
Coke 1	11.9	43	13.5	3763	469	13	1	25
Coke 2	12.2	53	14.4	4840	486	15	0	24
Coke 3	12.3	94	13.4	4527	425	23	0	32
Coke 4	11.8	93	13.6	4552	435	5	0	0
Coke 5	12.2	45	13.6	2486	216	5	0	0
Coke 6	12.5	81	13.9	4635	491	36	0	46
Coke 7	11.8	89	13.2	4430	392	121	200	330
Coke 8	13.0	16	14.0	2691	452	57	6	72
Coke 9	13.5	78	14.5	2644	644	65	14	88
Coke 10	13.3	89	14.3	3693	616	45	5	59
Coke 11	13.1	73	13.8	3752	593	51	16	75
Coke 12	12.7	11	13.5	2991	394	44	9	63
Coke 13	13.3	52	13.6	2645	575	55	9	72
Coke 14	13.3	32	13.9	3871	581	80	52	140
Coke 15	11.4	53	14.3	3725	470	39	7	56
Coke 16	12.4	60	13.9	3555	537	51	9	69
Coke 17	13.0	49	13.8	4044	487	52	9	70
Coke 18	12.9	23	13.7	3635	587	58	9	75
Coke 19	13.1	49	13.7	2297	544	40	9	58
Coke 20	13.5	57	13.8	2937	608	56	12	76
Coke 21	12.8	6	14.0	3087	454	287	35	330
Coke 22	13.0	7	14.3	1729	515	114	28	151

expressed as the difference between the initial O<sub>2</sub> content of the air (20.8%) and the percentage of O<sub>2</sub> at the exit of the reactor so as to deduce the quantity consumed by the combustion. The values ranged between 11.4% and 13.5%; this is equivalent to an average burnout of 80% for all the petcoke (from an O<sub>2</sub> balance).

The first objective of this work was to establish links between petcoke properties and combustion velocity, deduced from the burnout or from the oxygen consumed (O<sub>2cons</sub>). The correlation between O<sub>2cons</sub> and each of the properties of the petcoke were systematically investigated by testing linear fitting. In no case was the correlation coefficient  $r^2$  higher than 0.309.

As explained before, one could have expected that the oxygen consumed would have correlated to the BET surface; in fact, as indicated in Fig. 2,  $r^2$  is only 0.037. The reason for this is that the petcoke exhibit very similar BET surfaces, making it unlikely that this parameter would explain the differences in the combustion velocity of the petcoke.

The volatile matter content might also be considered as a parameter to influence the burnout, inasmuch as devolatilisation and oxidation in the volatile matter reactions are much quicker than char oxidation. The plot in Fig. 3 does not, however, show a significant correlation ( $r^2=0.011$ ).

The second aim of this work was to establish links between the petcoke properties and pollutant gas emissions. It should be mentioned at this point that all the gas molar fractions specified in Table 2 (except O<sub>2cons</sub>) have been converted at 3% O<sub>2</sub>. This conversion enables concentrations of the gas species that have been formed by the different petcoke with different burnout to be compared, avoiding the dilution effect by unreacted air.

As far as SO<sub>2</sub> emissions are concerned [5], the plot in Fig. 4, where SO<sub>2</sub> emissions are given in relation to the initial content in S of the petcoke, indicates a strong correlation:  $r^2=0.96$ . Moreover, it is possible to establish that the quantity of SO<sub>2</sub> that has been formed is proportional to the fuel burnout. A full conversion of S into SO<sub>2</sub> would theoretically lead to the SO<sub>2</sub> concentrations indicated by the dotted line in Fig. 4. The values obtained

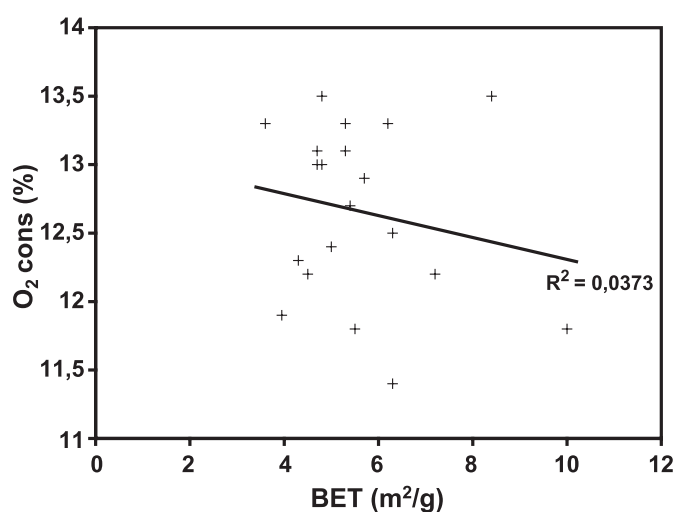

Fig. 2. Oxygen consumed during the combustion versus the specific surface of the char residues of the petcoke.



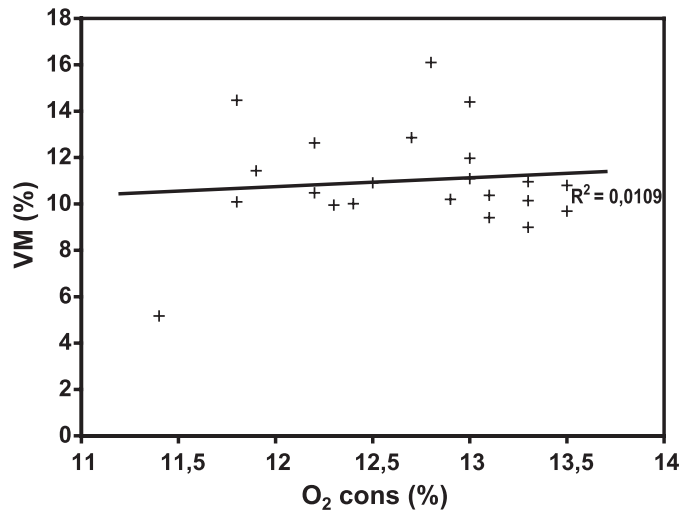

Fig. 3. Oxygen consumed during the combustion versus the volatile matter content of the petcokes.

experimentally for a burnout of approximately 80% appear to represent 80% of the full conversion. This observation was reported after investigations into the fate of S in coals [3].

The very high correlation coefficient obtained here also attests to the accuracy of the experiments. This point is particularly important in the context of experiments in the combustion of powdered solid fuels dispersed in a gas phase, which can be perturbed by phenomena such as the fuel-feeding rate fluctuations or bad dispersion of the fuel particles on the cross-section of the reactor.

None of the other fuel properties indicated a correlation to SO<sub>2</sub> emissions during the combustion of the petcokes.

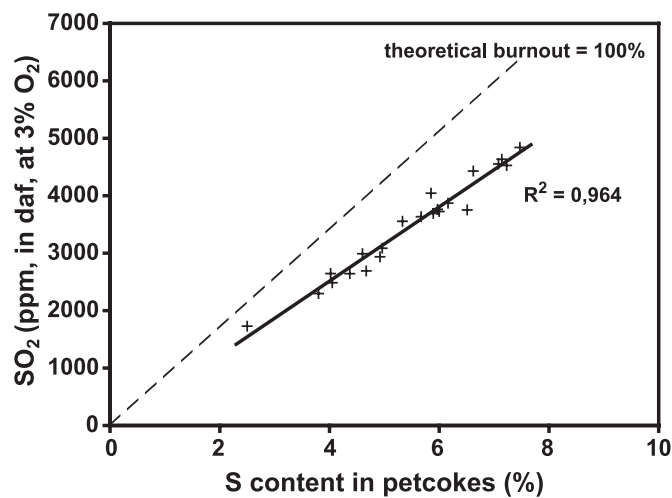

Fig. 4. Emissions of SO<sub>2</sub> versus the percentage of S in the petcokes.

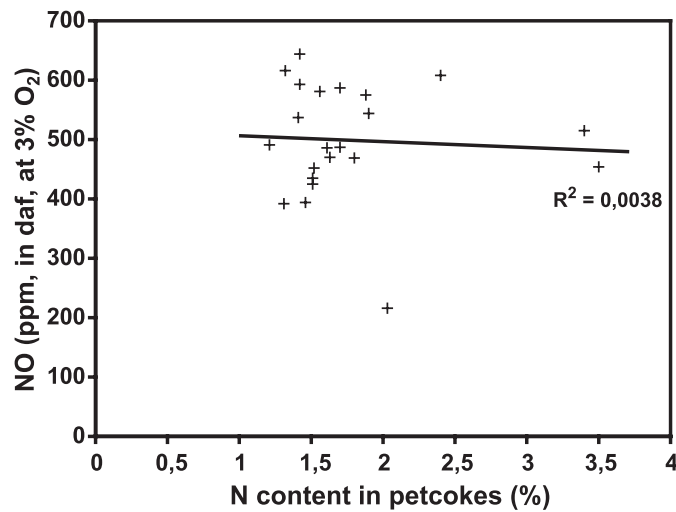

Fig. 5. Emissions of NO versus the percentage of N in the petcoke.

The emissions in NO were also confronted with each property of the petcoke with a view of identifying a correlation. The  $r^2$  was never higher than 0.15 (correlation between NO and VM), which indicates that it is not possible to predict NO emissions in a simple way.

The plot in Fig. 5 clearly shows that the initial N content of the petcoke does not determine ultimate NO emissions. This has been reported before in the case of coal [3]. Basically, the fuel nitrogen is released partly in gas phase during devolatilisation and during char oxidation; the NO present in the gas phase can also react with the solid residue to be reduced into N<sub>2</sub>. The kinetic of these reactions varies from one coke to another. The complexity of the phenomena involved explains why NO cannot be predicted only from the knowledge of the initial N content in the fuel.

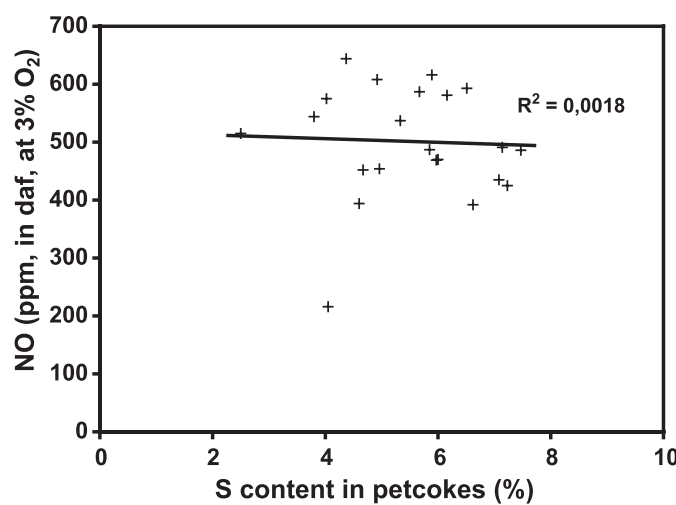

Fig. 6. Emissions of NO versus the percentage of S in the petcoke.

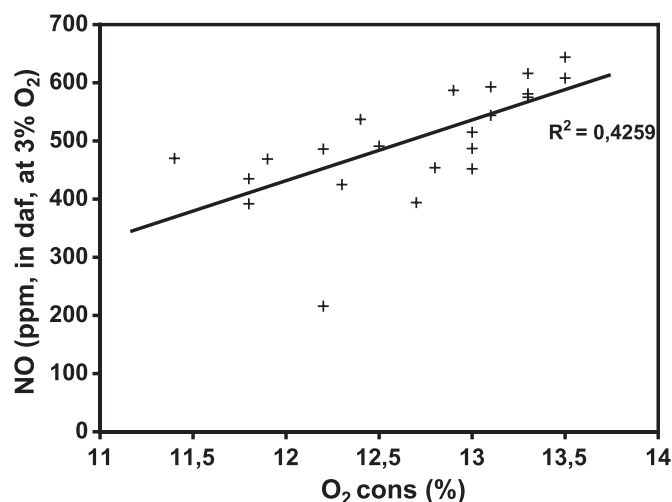

Fig. 7. Emissions of NO versus the oxygen consumed during the combustion of the petcokes.

The literature on the combustion of coal and other solid fuels points out that the presence of S species in the gas phase has an effect on the level of NO emissions resulting from the combustion [5–10]. For the case at fuel-lean conditions, which is the case in our experiments, the tendency observed by the authors is that when the sulphur concentration increases, NO concentration decreases. Considering this, we have plotted in Fig. 6 NO emissions versus the S content of the petcokes, which has been shown to be correlated with the SO<sub>2</sub> concentration of the gas phase. The plot does not indicate a correlation in the case of our petcokes, despite the fact that the content in S varies in a range as large as 2.5–7.47%.

As a complement to our search for correlation between the petcoke properties and gas phase pollutant emissions, we investigated the correlation between the different gas emissions themselves. As indicated in Fig. 7, a weak correlation ( $r^2=0.43$ ) exists between the combustion burnout, deduced from O<sub>2</sub>cons, and NO emissions. It should be remembered that NO concentration is converted at 3% O<sub>2</sub> so as to avoid dilution effects by the air that has not reacted. This relation between the burnout and NO is generally accepted for the fate of N in coals during combustion. Despite the fact that a number of other parameters influence NO emissions, it seems probable from these results that N is released in proportion to the burnout during petcoke combustion.

## 5. Catalytic effects

In previously presented work, the approach can be qualified as global in the sense that the gas emissions that were analysed result from a number of reactions that occur simultaneously during the combustion. These reactions are devolatilisation, char residue oxidation, gas phase reactions and also the heterogeneous reaction of a reduction of NO at the porous surface of the char residue. In parallel to the search for correlation, studies have been carried out in which these reactions were considered separately [1,2,16,19,20]. Some

Table 3  
Analyses of five metals, K and Ca in six of the petcokes (ppm)

Sample	V	Co	Mo	Iron	Mn	K	Ca
2	507	9.1	7.0	615	5.1	45	220
4	819	–	–	6	–	–	180
13	2570	1.9	1.4	93	0.5	10	20
14	1390	3.8	17.3	20	2.6	17	100
15	899	6.1	26.3	1740	17.1	15	150
17	1830	3.1	16.6	381	6.1	57	2190

of these results are relevant to the present investigation between the petcoke properties and their behaviour during combustion, and are presented here.

The catalytic effect of metals present in a solid fuel is known to be potentially very influential in the combustion process [21–25]. We selected 6 petcokes among the 22, covering the range of reactivities observed, and we quantified the following metals: vanadium, copper, molybdenum, iron and manganese. Potassium and calcium were also analysed. The results are grouped in Table 3.

- In Fig. 8, we plotted on the Y-axis the content of all the metals versus  $O_{2\text{cons}}$ , the amount of oxygen consumed during the combustion of the petcoke in the EFR. It seems that vanadium, which is present in quantities up to 2570 ppm, has a nonnegligible catalytic effect on the combustion velocity of the petcokes. It was nevertheless found in another work that the combustion of petcokes in a thermogravimetry crucible strongly correlated to the amount of V in the fuel. The reader can refer to Refs. [12,26] for more details.
- The reaction during which NO in the gas phase is reduced at the char surface is known to play an important role in NO balance during the combustion of carbonaceous fuels [15,27–29]. Experimental work carried out in the past showed that quantities of 185–849 ppm (starting from 955 ppm at the inlet) could be reduced within several seconds at

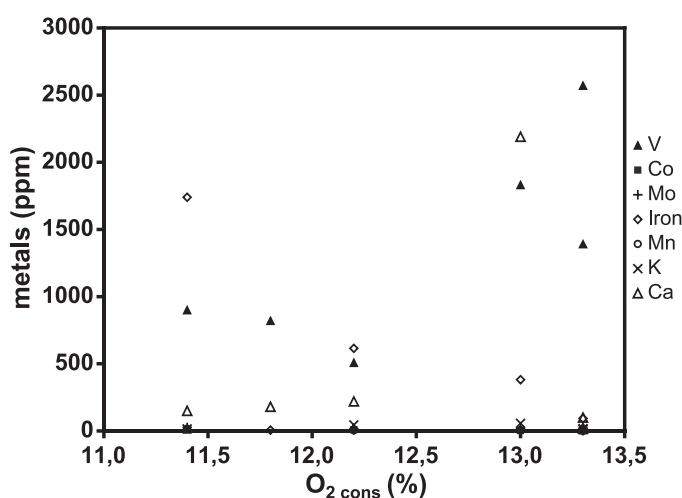

Fig. 8. Metals content in petcokes versus oxygen consumed during the combustion.

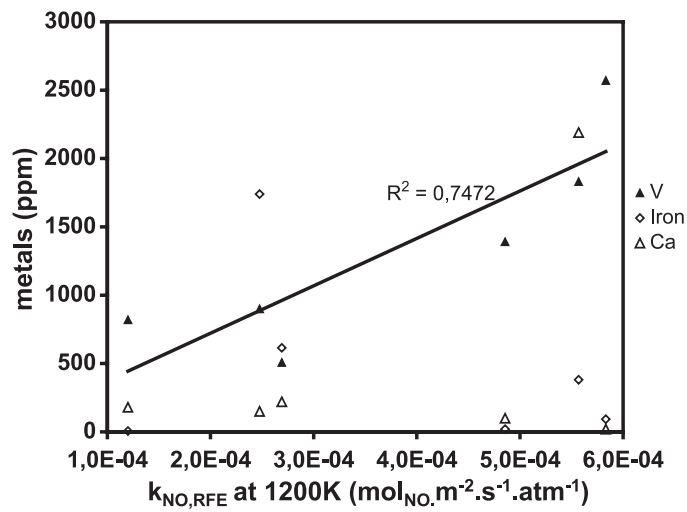

Fig. 9. Vanadium, iron and calcium content versus the reaction rate for the reduction of NO at the char surface.

temperatures of 800–1000 °C [16]. It has been shown previously that the higher the amount of V in the petcoke, the more rapid the reaction is [13]. This is illustrated in the two figures where we have plotted the amount of vanadium, iron and calcium (Fig. 9) and copper, molybdenum, manganese and potassium (Fig. 10) in relation to the reaction rate for the reduction of NO at the char surface. The reaction rates were calculated from the concentration in NO at the exit of the reactor and were assuming a plug flow reactor [16]. A clear correlation is observed. Consequently, one could expect that the amount of V in the petcoke will determine the amount of NO present in the flue gases of the combustion. Nevertheless, as discussed previously, the NO present in the flue gas of the EFR is the result of a large number of phenomena; this is why the correlation observed

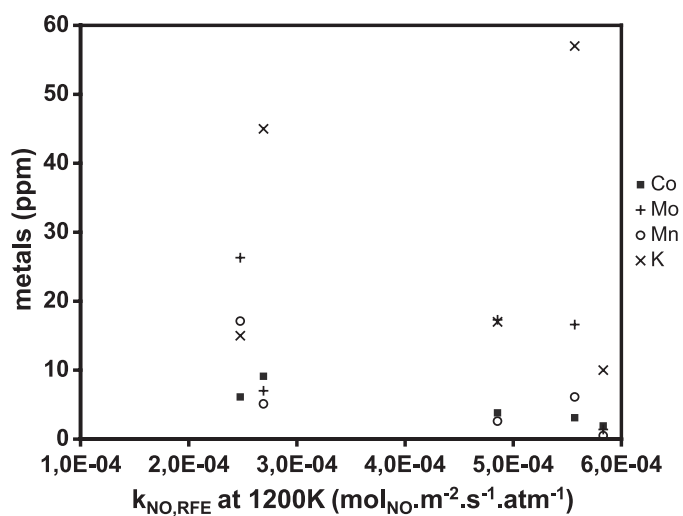

Fig. 10. Metals content versus the reaction rate for the reduction of NO at the char surface.

here is not explained as a correlation between NO emissions and the amount of V in the petcoke.

## 6. Conclusion

A systematic search for correlation between the petcoke properties—in terms of the chemical composition, proximate analysis, physical structure and LCV—and their behaviour during combustion brought the following conclusions:

- The velocity of combustion of a petroleum coke or burnout reached after a given time cannot be correlated with any of the petcoke properties, including the volatile matter content. The catalytic effect of vanadium, which may be present in the petcoke at a mass fraction up to 2570 ppm, has a nonnegligible effect on the burnout.
- The SO<sub>2</sub> emissions are very well correlated ( $r^2=0.96$ ) to the initial amount of S in the petcoke. The present work, based upon a large number of petcoke, also confirms a probable release of S from the solid fuel proportionally to particle burnout, as suggested by previous authors.
- The NO emissions cannot be predicted simply from the petcoke properties. They are not correlated with the N content of the fuel. This observation can be understood by considering the large number of phenomena that participate in the formation and reduction of NO and which can be more or less efficient from one petcoke to another. In previous works, we have shown that the reduction of NO at the char surface has an important impact on NO balance, and that this reaction is catalysed by the vanadium entering the composition of the petcoke. The present work shows that this impact is not sufficient to impose a correlation between NO emissions due to the combustion and the content in V of the petcoke.

## References

- [1] P. Glarborg, A.D. Jensen, J.E. Johnsson, Some aspects of fuel nitrogen conversion in solid fuel fired systems Invited lecture N °3, -6th International conference on technologies and combustion for a clean environment, Clean Air 6, Porto, 2001.
- [2] K.M. Thomas, The release of nitrogen oxides during char combustion, Fuel 76 (1997) 457.
- [3] E. Hampartsoumian, W. Nimmo, B.M. Gibbs, Nitrogen sulphur interactions in coal flames, Fuel 80 (2001) 887.
- [4] G.G. De Soete, Aspects chimiques de la combustion du charbon pulvérisé—2<sup>ème</sup> partie, Revue de l'Institut Français du Pétrole 37 (4) (1982) 503.
- [5] J.M. Commandré, S. Salvador, G. Charnay, Investigating the influence of sulfur on NO formation during the combustion of highly sulphurised petcoke, -6th International conference on technologies and combustion for a clean environment, Clean Air 6, Porto, 2001.
- [6] L.E. Amand, B. Leckner, K. Dam-Johansen, Influence of SO<sub>2</sub> on the NO/N<sub>2</sub>O chemistry in fluidized bed combustion: 1. Full-scale experiments, Fuel 72 (1993) 557.
- [7] E.J. Anthony, Y. Lu, Relationship between SO<sub>2</sub> and other pollutants emissions from fluidised-bed combustion, -27th International symposium on combustion, Combustion Institute, 1998, p. 3093.
- [8] T.L. Corley, J.O.L. Wendt, Postflame behavior of nitrogenous species in the presence of fuel sulfur: II. Rich, CH<sub>4</sub>/He/O<sub>2</sub> flames, Combustion and Flame 58 (1984) 141.

- [9] K. Dam-Johansen, L.E. Amand, B. Leckner, Influence of SO<sub>2</sub> on the NO/N<sub>2</sub>O chemistry in fluidized bed combustion: 2. Interpretation of full-scale observations based on laboratory experiments, *Fuel* 72 (4) (1993) 565.
- [10] C.J. Tullin, A.F. Sarofim, J.M. Beer, J.D. Teare, Effect of SO<sub>2</sub> and NO on the conversion of fuel nitrogen to N<sub>2</sub>O and NO in single particle combustion of coal, *Combustion Science and Technology* 106 (1995) 153.
- [11] J.M. Commandré, Formation des oxydes d'azote lors de la combustion de cokes de pétrole dans des conditions de précalcinateur de cimenterie, PhD thesis, 2002.
- [12] S. Salvador, J.M. Commandré, B.R. Stanmore, The catalytic effect of vanadium on the reactivity of petcoke with O<sub>2</sub> and NO, 7th International conference on energy for a clean environment, *Clean Air* 7, Lisbon, 2003.
- [13] S. Salvador, J.M. Commandré, B.R. Stanmore, R. Gadiou, The catalytic effect of vanadium on the reactivity of petroleum cokes with NO, *Energy and Fuels* 18 (2004) 296.
- [14] J.M. Commandré, S. Salvador, G. Charnay, R. Gadiou, The formation and reduction of NO during the combustion of petroleum cokes: the case of cement plant precalciner conditions, *Combustion Science and Technology*, accepted.
- [15] I. Aarna, E.M. Suuberg, A review of the kinetics of the nitric oxide-carbon reaction, *Fuel* 76 (6) (1997) 475–491.
- [16] J.M. Commandré, B.R. Stanmore, S. Salvador, The high temperature reaction of carbon with nitric oxide, *Combustion and Flame* 128 (2002) 211.
- [17] J.E. Johnsson, Formation and reduction of nitrogen oxides in fluidized-bed combustion, *Fuel* 73 (1994) 1398.
- [18] L. Van De Steene, S. Salvador, G. Charnay, Controlling powdered fuel combustion at low temperature in a new entrained flow reactor: laboratory experiments and modelling, *Combustion Science and Technology* 159 (2000) 255.
- [19] D.W. Blair, J.O.L. Wendt, W. Bartok, Evolution of nitrogen and other species during controlled pyrolysis of coal, -16th International Symposium on combustion Combustion Institute, 1977, p. 475.
- [20] K.M. Thomas, The release of nitrogen oxides during char combustion, *Fuel* 76 (1997) 457.
- [21] M.J. Illan-Gomez, A. Linares-Solano, C. Salinas-Martinez de Lecea, J.M. Calo, NO reduction by activated carbons: 1. The role of carbon porosity and surface area, *Energy and Fuels* 7 (1993) 146.
- [22] M.J. Illan-Gomez, A. Linares-Solano, L.R. Radovic, C. Salinas-Martinez de Lecea, NO reduction by activated carbons: 5. Catalytic effect of iron, *Energy and Fuels* 9 (1995) 540.
- [23] M.J. Illan-Gomez, A. Linares-Solano, C. Salinas-Martinez de Lecea, NO reduction by activated carbons: 6. Catalysis by transition metals, *Energy and Fuels* 9 (1995) 976.
- [24] M.J. Illan-Gomez, A. Linares-Solano, L.R. Radovic, C. Salinas-Martinez de Lecea, NO reduction by activated carbons: 7. Some mechanistic aspects of uncatalyzed and catalyzed reaction, *Energy and Fuels* 10 (1996) 158.
- [25] M.J. Illan-Gomez, C. Salinas-Martinez de Lecea, A. Linares-Solano, L.R. Radovic, Potassium-containing coal chars as catalysts for NO<sub>x</sub> reduction in the presence of oxygen, *Energy and Fuels* 12 (1998) 1256.
- [26] S. Salvador, J.M. Commandré, B.R. Stanmore, Reaction rates for the oxidation of highly sulphurised petroleum cokes: the influence of thermogravimetric conditions and some coke properties, *Fuel* 82 (2003) 715.
- [27] J.E. Johnsson, Formation and reduction of nitrogen oxides in fluidized bed combustion, *Fuel* 73 (1994) 1398.
- [28] Y.H. Li, Kinetics study of NO and N<sub>2</sub>O reduction with coal chars, PhD thesis, Brisbane, Australia, 1999.
- [29] G.G. De Soete, Aspects chimiques de la combustion du charbon pulvérisé—2<sup>ème</sup> partie, *Revue de l'institut français du pétrole* 37 (1982) 503.