



HAL
open science

EEG-based Visual Attentional State Decoding Using Convolutional Neural Network

Soheil Borhani, Reza Abiri, J I Muhammad, Yang Jiang, Xiaopeng Zhao

► **To cite this version:**

Soheil Borhani, Reza Abiri, J I Muhammad, Yang Jiang, Xiaopeng Zhao. EEG-based Visual Attentional State Decoding Using Convolutional Neural Network. 7th International BCI Meeting, May 2018, Pacific Grove, CA, United States. pp.1-D-32. hal-01843916v2

HAL Id: hal-01843916

<https://hal.science/hal-01843916v2>

Submitted on 28 Sep 2018

HAL is a multi-disciplinary open access archive for the deposit and dissemination of scientific research documents, whether they are published or not. The documents may come from teaching and research institutions in France or abroad, or from public or private research centers.

L'archive ouverte pluridisciplinaire **HAL**, est destinée au dépôt et à la diffusion de documents scientifiques de niveau recherche, publiés ou non, émanant des établissements d'enseignement et de recherche français ou étrangers, des laboratoires publics ou privés.

EEG-based Visual Attentional State Decoding Using Convolutional Neural Network

Soheil Borhani¹, Reza Abiri², Jabril Ibrahim Muhammad³, Yang Jiang⁴, Xiaopeng Zhao¹

¹Department of Mechanical, Aerospace, and Biomedical Engineering, University of Tennessee, Knoxville, USA,

²Department of Neurology, University of California, San Francisco/Berkeley, CA, USA,

³Department of Electrical Engineering and Computer Science, University of Tennessee, Knoxville, USA,

⁴Department of Behavioral Science, College of Medicine, University of Kentucky, Lexington, USA

Introduction

Maintaining sustained visual attention to a cognitive task is of high importance [1]. Recent studies in Brain-Computer Interface (BCI) using electroencephalography (EEG) shows a promising capability to reveal moment-to-moment attentional states [2]. A number of studies highlight the implication of Event-Related Potentials (ERPs) such as N170 or P300, yet some other studies identified the significance of alpha and beta bands elicited from specific parts of human scalp in spotting level of attention. In the present study, we developed a deep learning approach to analyzing the neurophysiological signals collected during a visual attention task. An individualized EEG-based classifier was developed to probe and extract underlying subject-specific features of early visual attention.

Experiment Setup

The BCI platform will consist of a wireless EEG headset, a workstation computer with dual monitors, data acquisition, and analysis software.

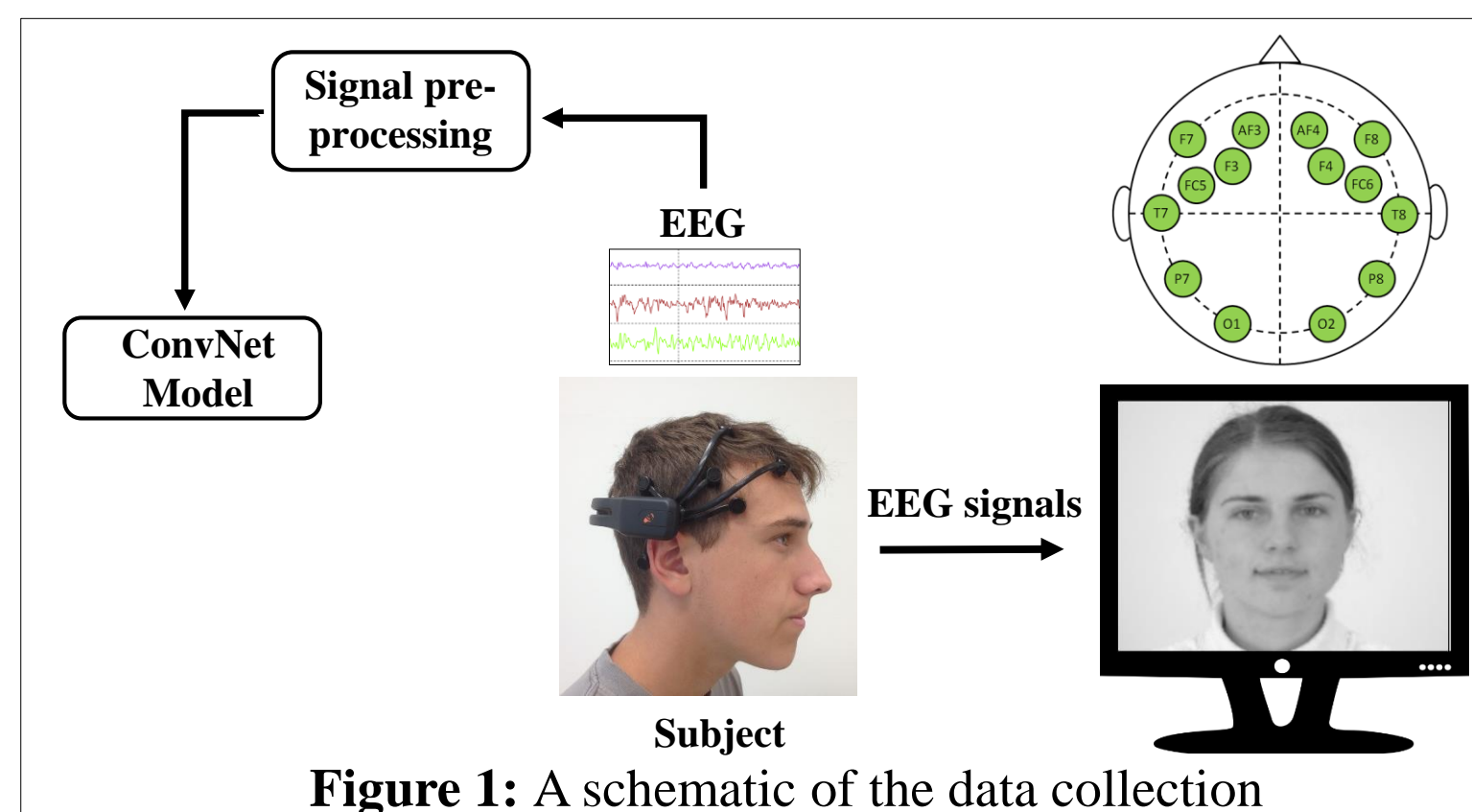

Figure 1: A schematic of the data collection

A flexible Graphical User Interface (GUI) has been developed to allow the experimenter to conveniently administer the experimental protocols. The data collection protocol is borrowed and adapted from a fMRI study [32]. Simulink is adopted as the data acquisition engine; the signal processing, feature extraction, classification, presenting the images, and recording behavioral responses were all carried out within MATLAB. The participants were primed into the subcategories throughout the experiment by asking their overt response during each trial.

Data

Thirty-eight healthy participants (11 females; 21.3 ± 1.9 years and 27 males; 23.1 ± 5.2 years) were recruited to conduct tasks on visual attentional state evaluation.

The participants were exposed to 8 blocks of 50 trials. Each trial is a single image followed by a black screen. Each block starts with a 1000ms cue texture that guides participants on the requested behavioral response. Then, it continues with showing single images randomly selected from scene subcategories (Indoor scene & outdoor scene) or face subcategories (male face & female face) with a black screen between images. Each image will be shown for 1000ms and the black screen for 1000ms to 1500ms.

We also collected the behavioral response via keyboard button presses.

Method

Information is reflected in the EEG as dynamical changes in **time**, **frequency**, and **space**. Among various time-frequency analysis methods, Wavelet transform stands out for the efficiency. This technique brings multi-resolution analysis to analyze EEG at different scales. EEG records for each block were divided into 50 epochs. Each epoch includes EEG records when subjects exposed to an image plus one second EEG record during the successive blank image.

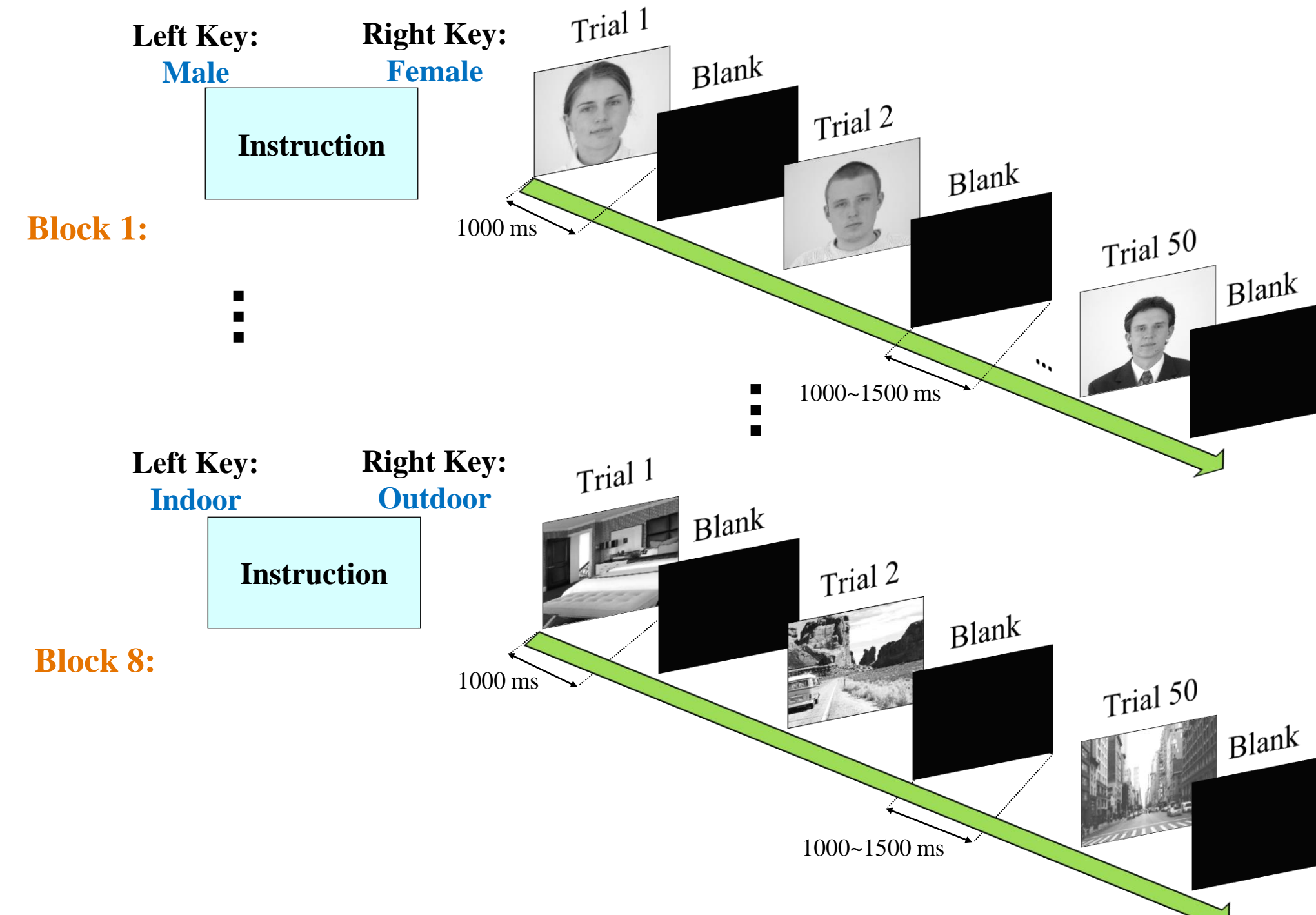

Figure 2: An illustration of the experimental data collection protocol

A Convolutional Neural Network (CNN) classifier inspired by AlexNet has been developed. Two different representations of the EEG data were used as input to the CNN classifier. The first approach utilizes a spatio-temporal representation and the second one utilizes a spatio-spectral representation. We also used Adam optimizer to adapt the learning rate while preventing the fluctuations of the gradient descent.

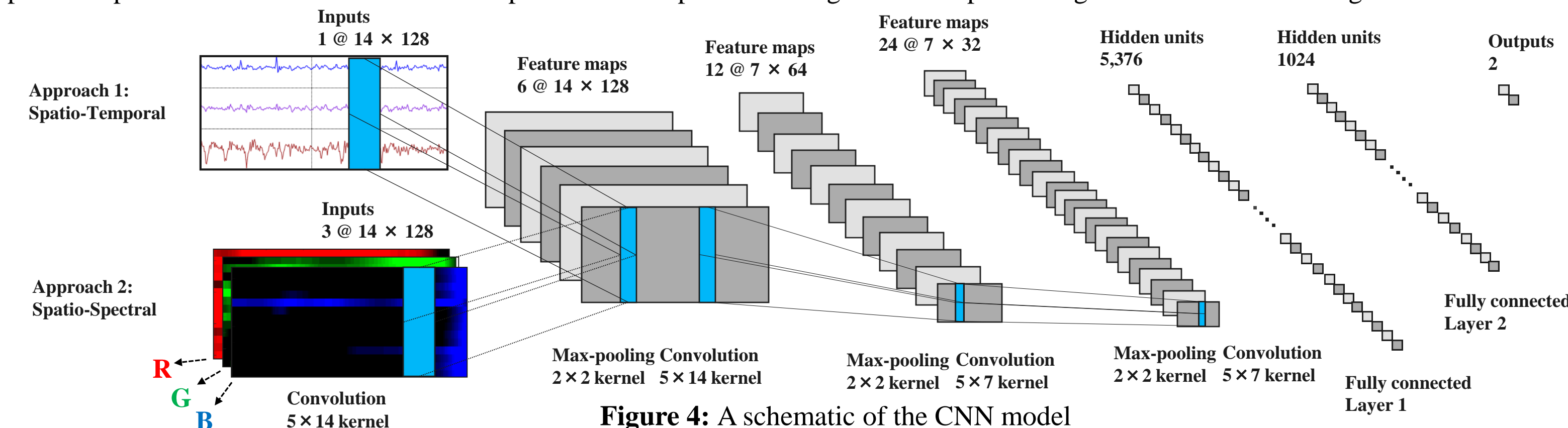

Figure 4: A schematic of the CNN model

Results

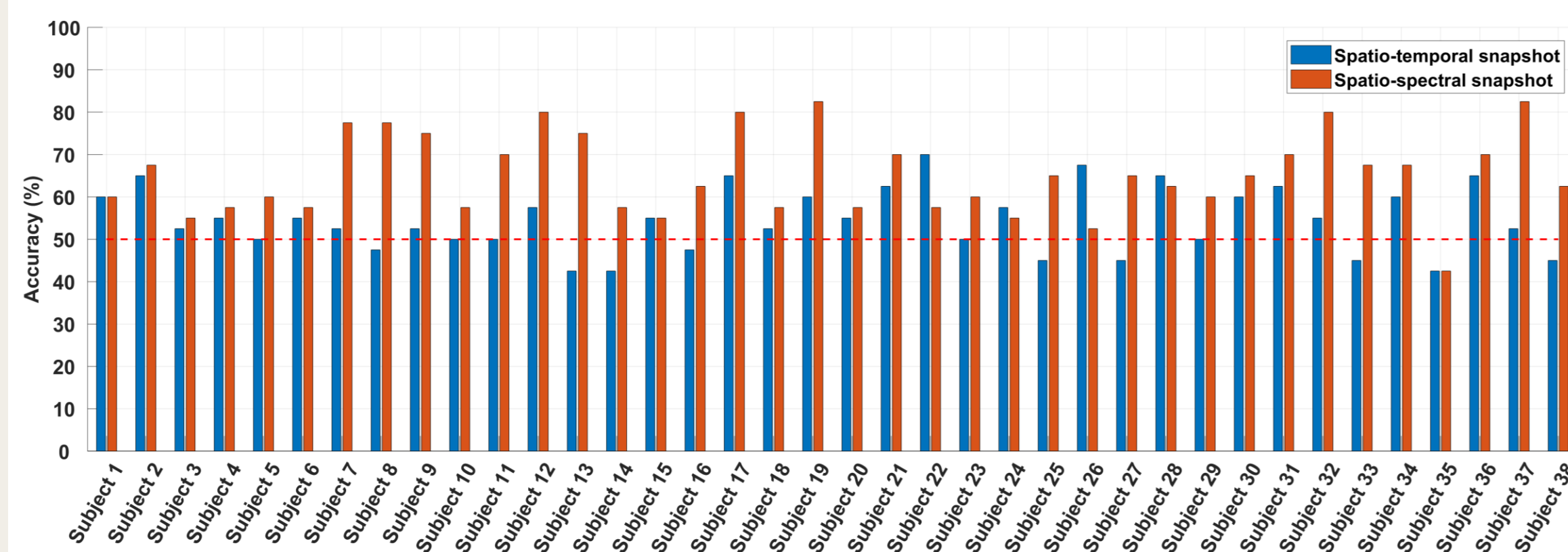

Figure 5: Accuracy of decoding over the individual participant

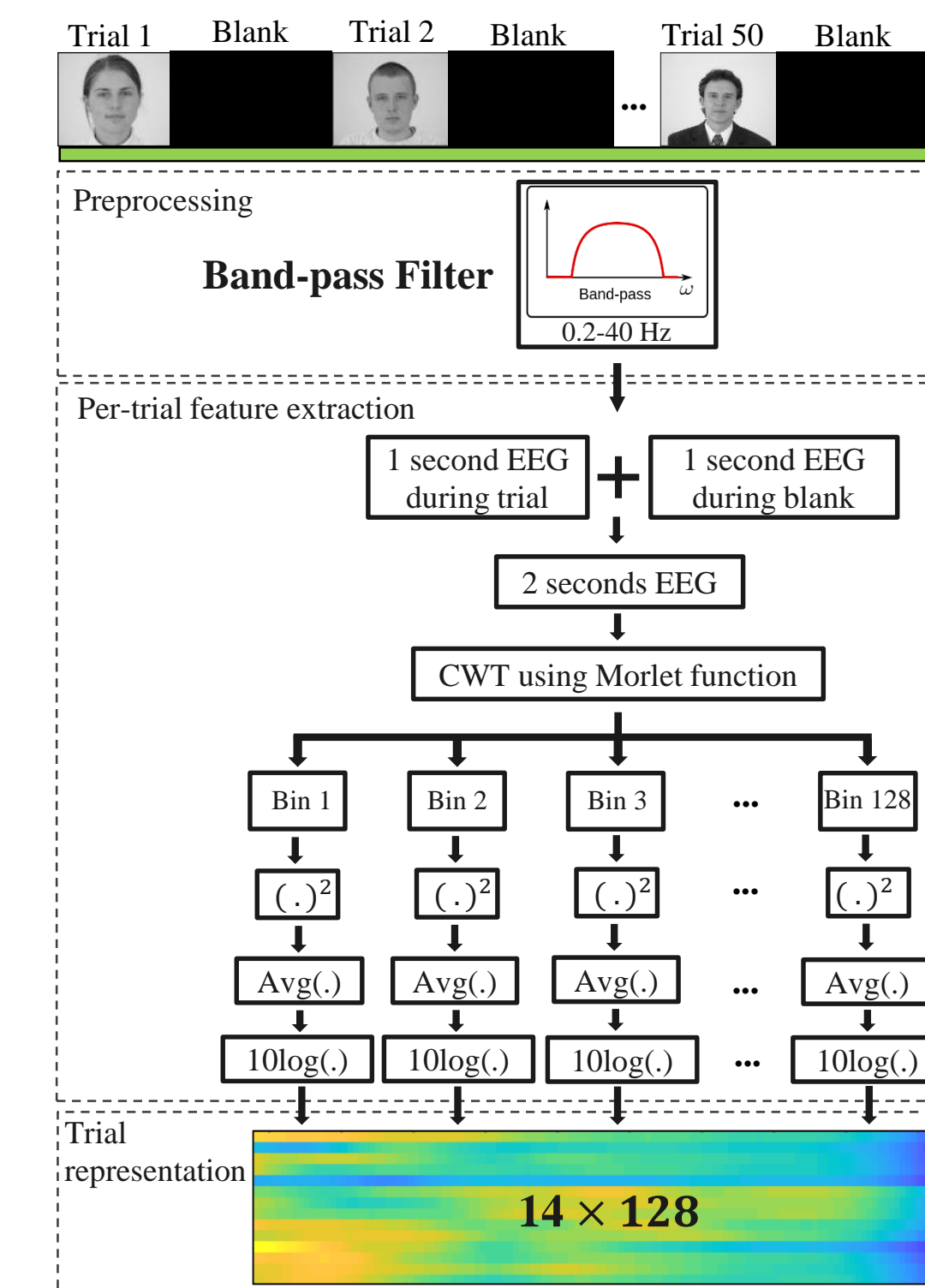

Figure 3: A flowchart of EEG data representation

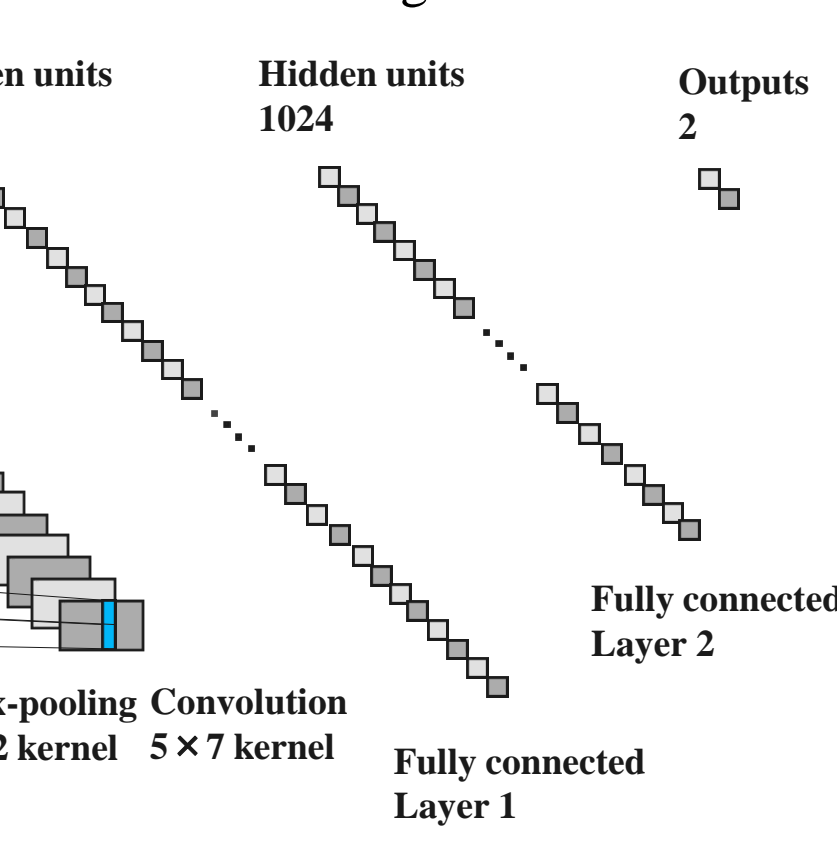

Figure 6: Mean decoding accuracy over different dropout probability

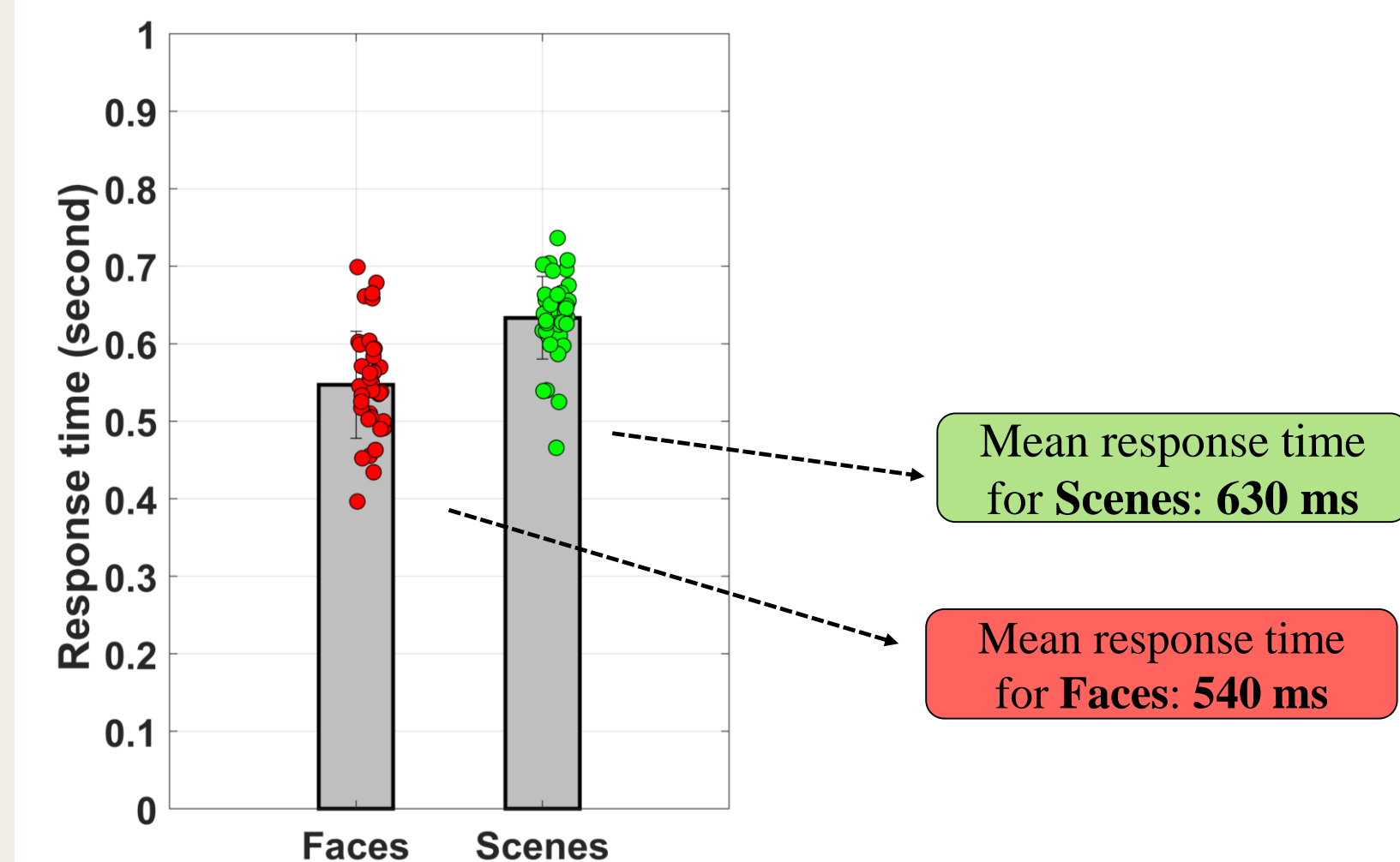

Figure 7: Average response time for faces and scenes

Rectified Linear Unit (ReLU) activation function was used as a nonlinear function. We also used Adam optimizer to adapt the learning rate while preventing the fluctuations of the gradient descent. On average, a dropout with a probability of 0.2 (Keep Prob = 0.8) in the fully connected layers resulted in higher accuracy over the dataset. Overall, the first approach achieved an average accuracy of 55% and the second approach achieved an average accuracy of 73%.

Two different representations were studied. The spatio-spectral representations lead to more accurate results compared to spatio-temporal representations. The size and architecture of the model are designed in a way that training the model would be considerably fast (less than 1 minute for each participant's dataset using a workstation equipped with a Titan Xp GPU, an 8-core i7 CPU, and 32 GB RAM) and enable it to run on small machines.

Conclusion

This study shows that EEG signal can be used to distinguish attentional state using visual stimuli. The proposed deep learning approach has advantages over the conventional selective visual attention decoding procedures [3]; instead of using engineered features of the EEG, we developed a classifier based on the convolutional neural network using learned features.

We are also interested in more complex snapshot-based models such as VGGNet and ResNet. The temporal correlation between samples of EEG suggests that Recurrent Neural Network (RNN) may result in a higher accuracy. We aim to apply a sequential model in the future. The findings of this study may be beneficial to people with attention deficit and attention disorder. Also, the platform may improve the understanding of the causal attributes of human visual attention.

Bibliography

- [1] R. Abiri, S. Borhani, X. Zhao, and Y. Jiang, 2017. *Real-Time Neurofeedback for Attention Training: Brainwave-Based Brain-Computer Interface*, Organization for Human Brain Mapping (OHBM 2017), Vancouver, Canada, June 25-29, 2017.
- [2] Y. Jiang, R. Abiri, X. Zhao, *Tuning Up the Old Brain with New Tricks: Attention Training via Neurofeedback*, Frontiers in Aging Neuroscience, 239996, 2017.
- [3] P. Bashivan, I. Rish, M. Yeasin, & N. Codella, "Learning representations from EEG with deep recurrent-convolutional neural networks." arXiv preprint arXiv:1511.06448 (2015).