

COMBUSTION OF ALUMINUM PARTICLES IN SOLID ROCKET MOTORS

Background

Metal combustion has an interesting **energetic potential** and an elevated temperature flame. According to its high energetic density, **aluminum micrometric particles** are currently used in industrial solid propellants, especially to **increase thrust** of solid rocket motors (SRM). However, aluminum particles combustion is a complex process sensitive to many parameters. Indeed it is already proved that combustion time depends on particle diameter. Thus, the initial particle size impacts combustion dynamic and larger particles burn as vapor flame in a **diffusion mode** whereas smaller particles combustion occurs in a **kinetic-limited regime**. Relying on experiments, different other factors like **pressure** or **ambient composition** change the aluminum **burning time** and determination of dependence with influencing parameters is an ongoing effort to elaborate accurate correlations, especially in less documented atmospheres such as CO, CO₂ or H₂O which are oxidizers released by solid propellant combustion.

Objectives

Explain and quantify influence of ambient SRM conditions on combustion process analyzing single burning aluminum particle :

- Development of an experimental technique with high-speed image processing
- Determination of combustion time dependence to improve numerical simulations
- Improvement of phenomenological understanding

Experimental set-up

- Single aluminum particle (30-150µm) is isolated in an electrodynamic levitator confined in a high pressure chamber supplied by various gases [1].

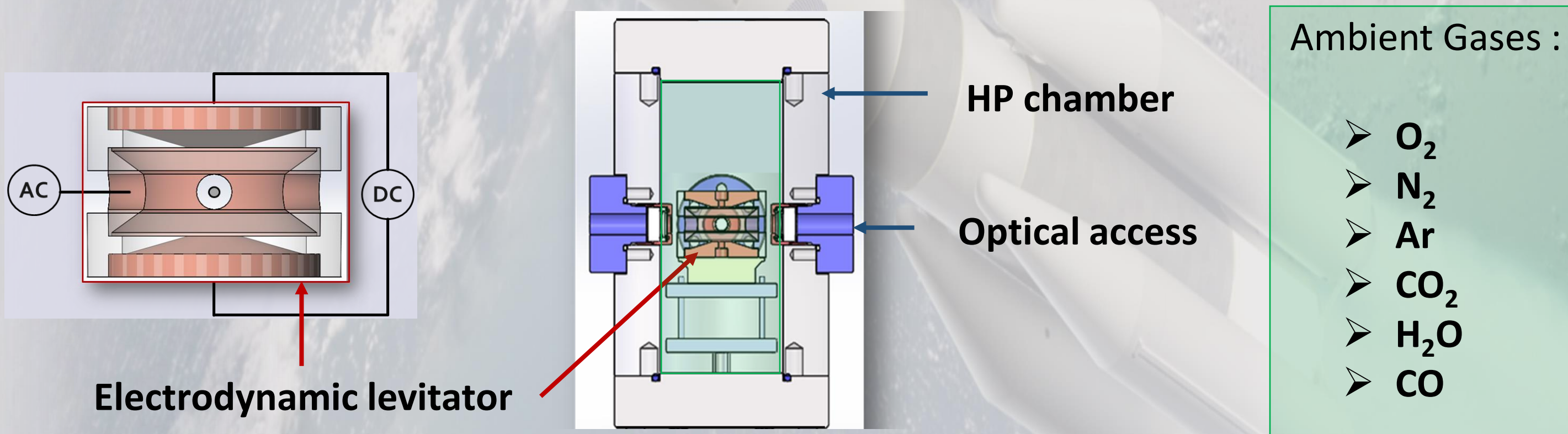

- Autonomous combustion is initiated by using a separated CO₂ laser beam.
- Optical signature of burning aluminum particle is recorded using filtered photomultipliers and a high-speed camera.

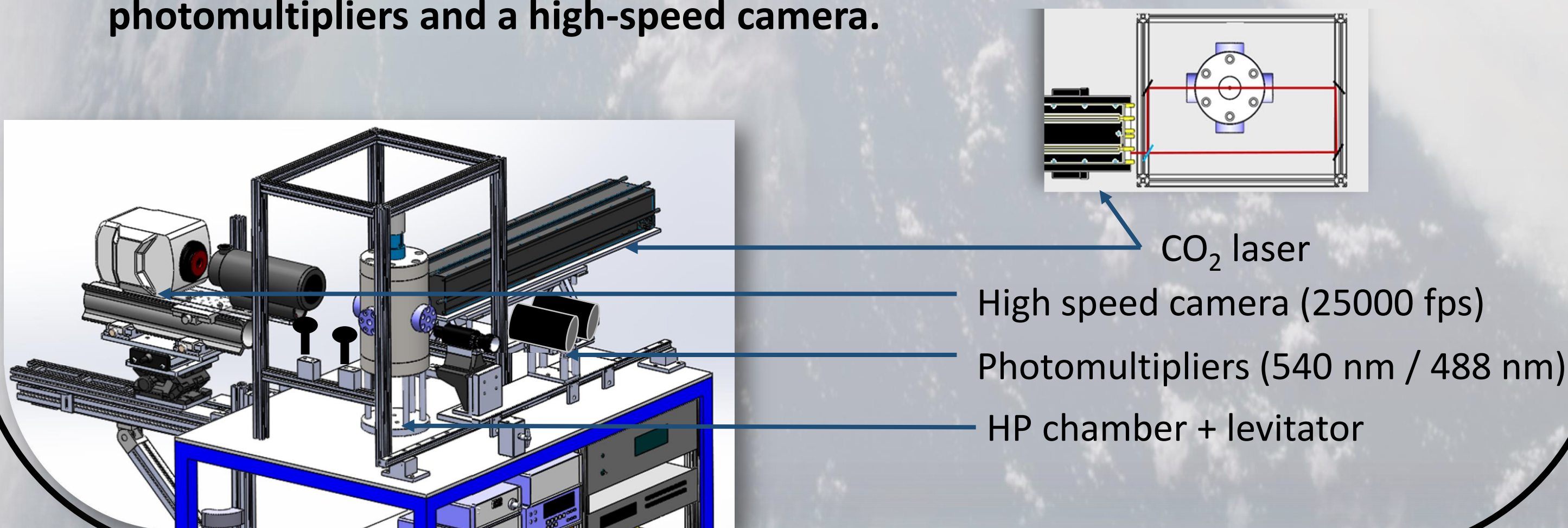

Results

- Recording of optical emissions and laser signal during combustion sequences

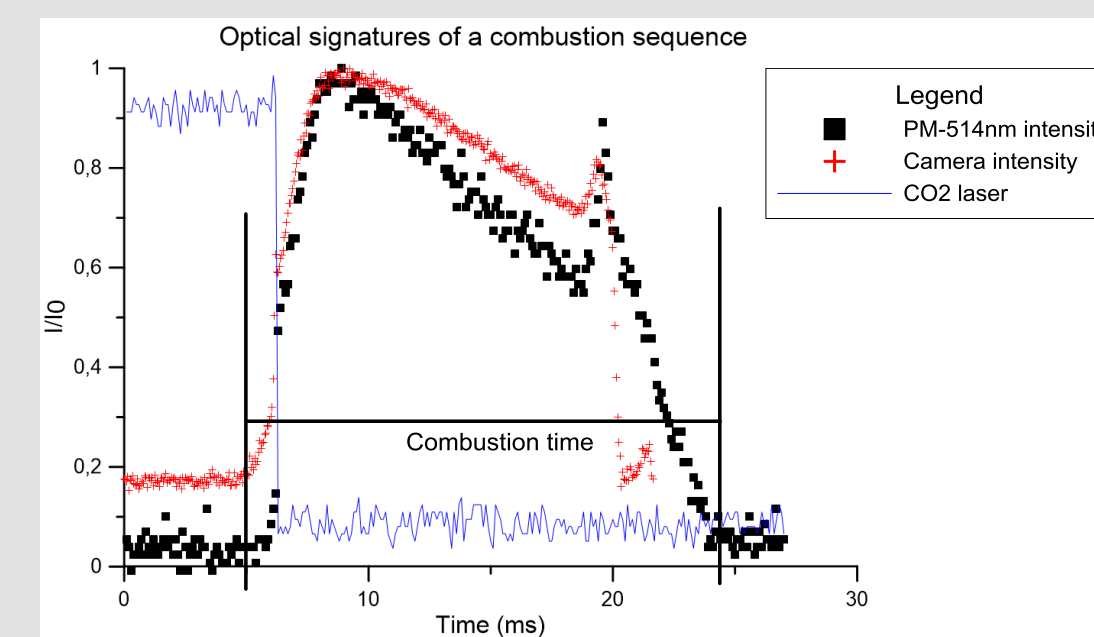

- Combustion time
- Temporal identification of singular emissions
- Confirmation of laser extinction

- Recording of dynamic combustion sequences

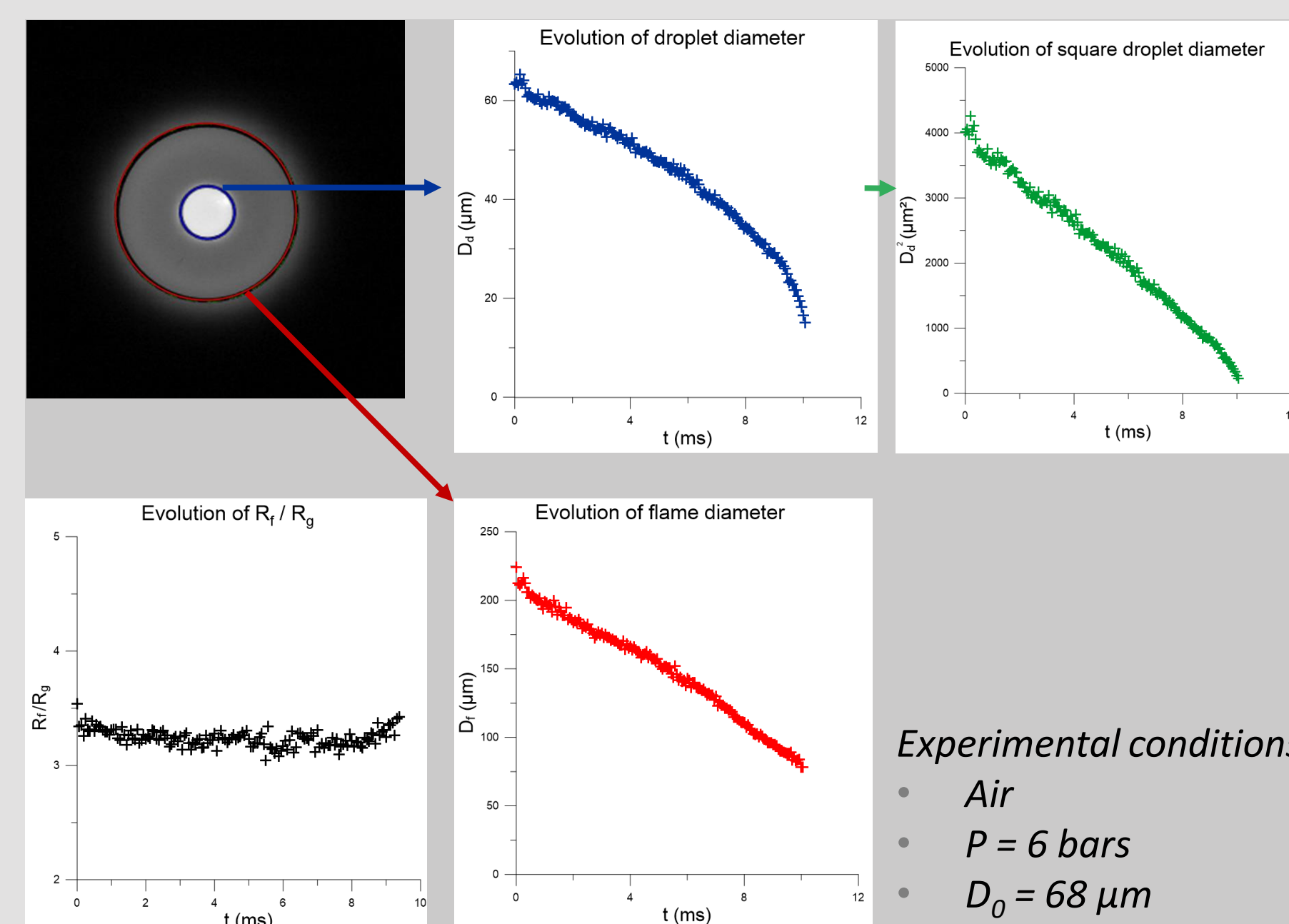

- Combustion time t_c
- Initial droplet diameter D_0
- Evolution of droplet diameter D_g
- Evolution of flame diameter D_f
- Identification of phenomena

- Highlighting the existence of different stages [2] of combustion

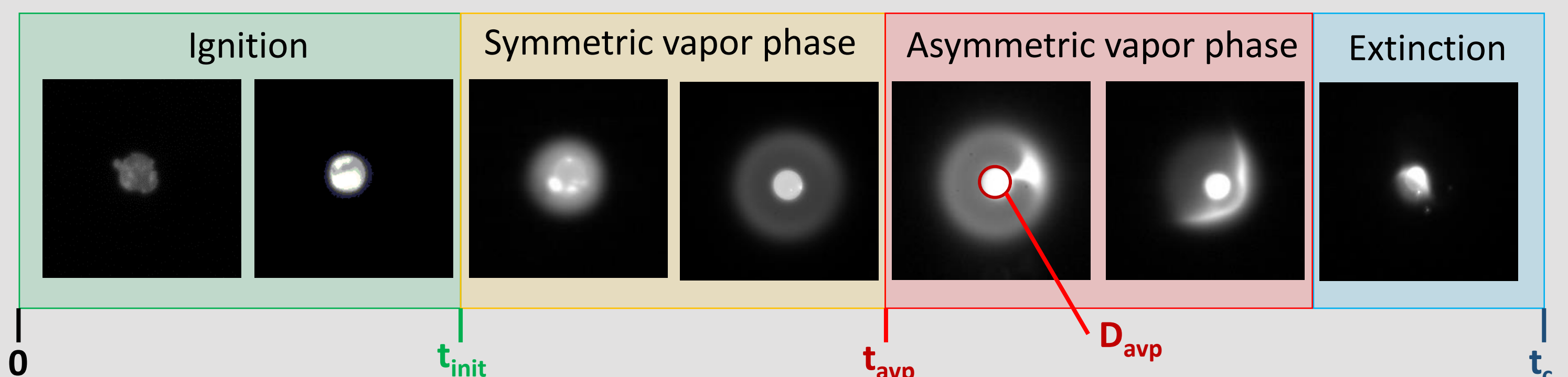

Experimental conditions :

- Air
- P = 1 bars
- D₀ = 90 µm

- Existence of a symmetric and asymmetric vapor phase (avp) regimes
- Introduction of related parameters : t_{avp} and D_{avp} , respectively time and droplet diameter before asymmetric phase occurrence.

- Combustion in air at various pressure : 1 to 31 bars

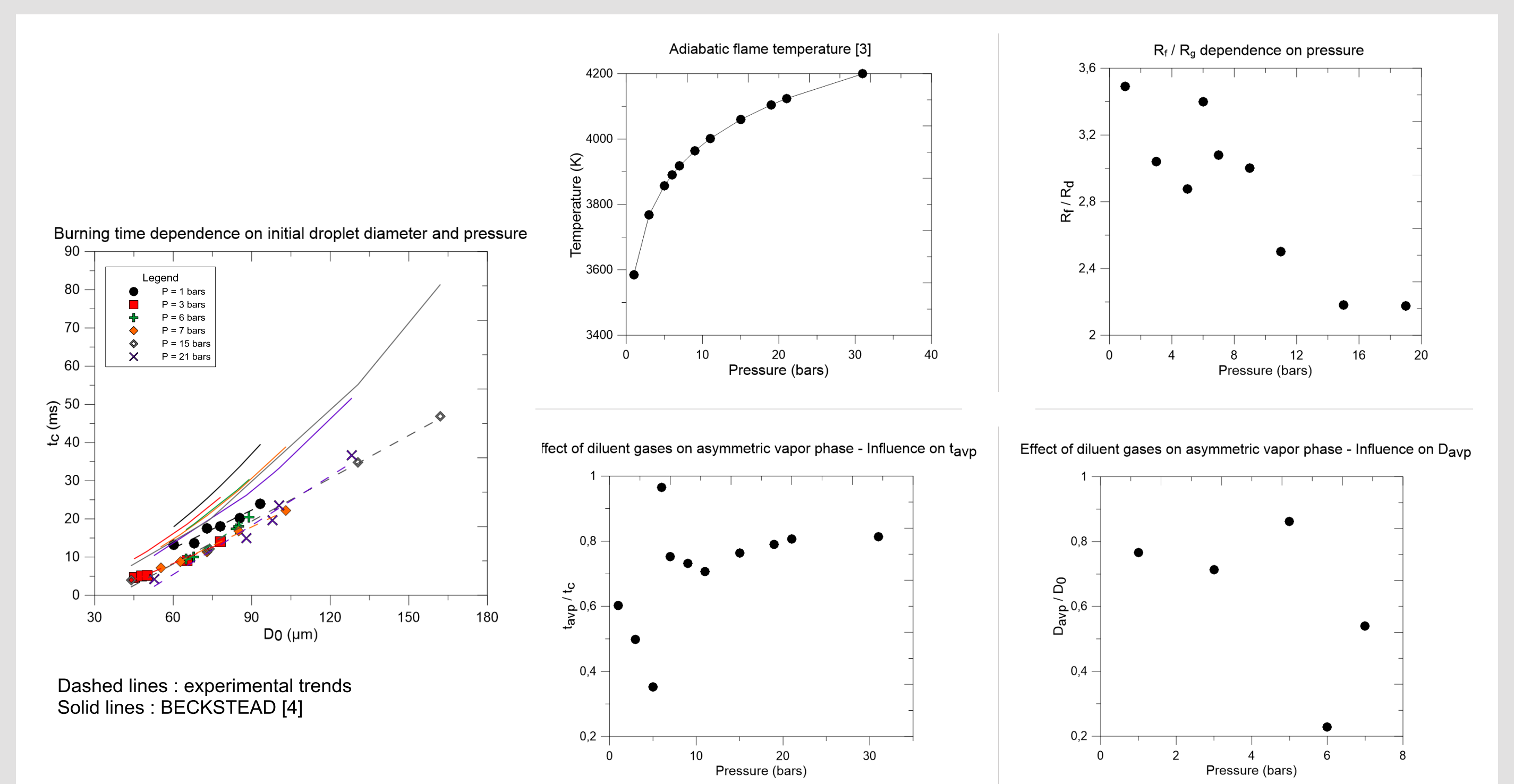

- Varying pressure in a low range seems to modify combustion times and related parameters of asymmetric vapor phase. Influence of higher pressure is then less considerable.

- Combustion in various mixtures at atmospheric pressure : O₂-N₂-Ar

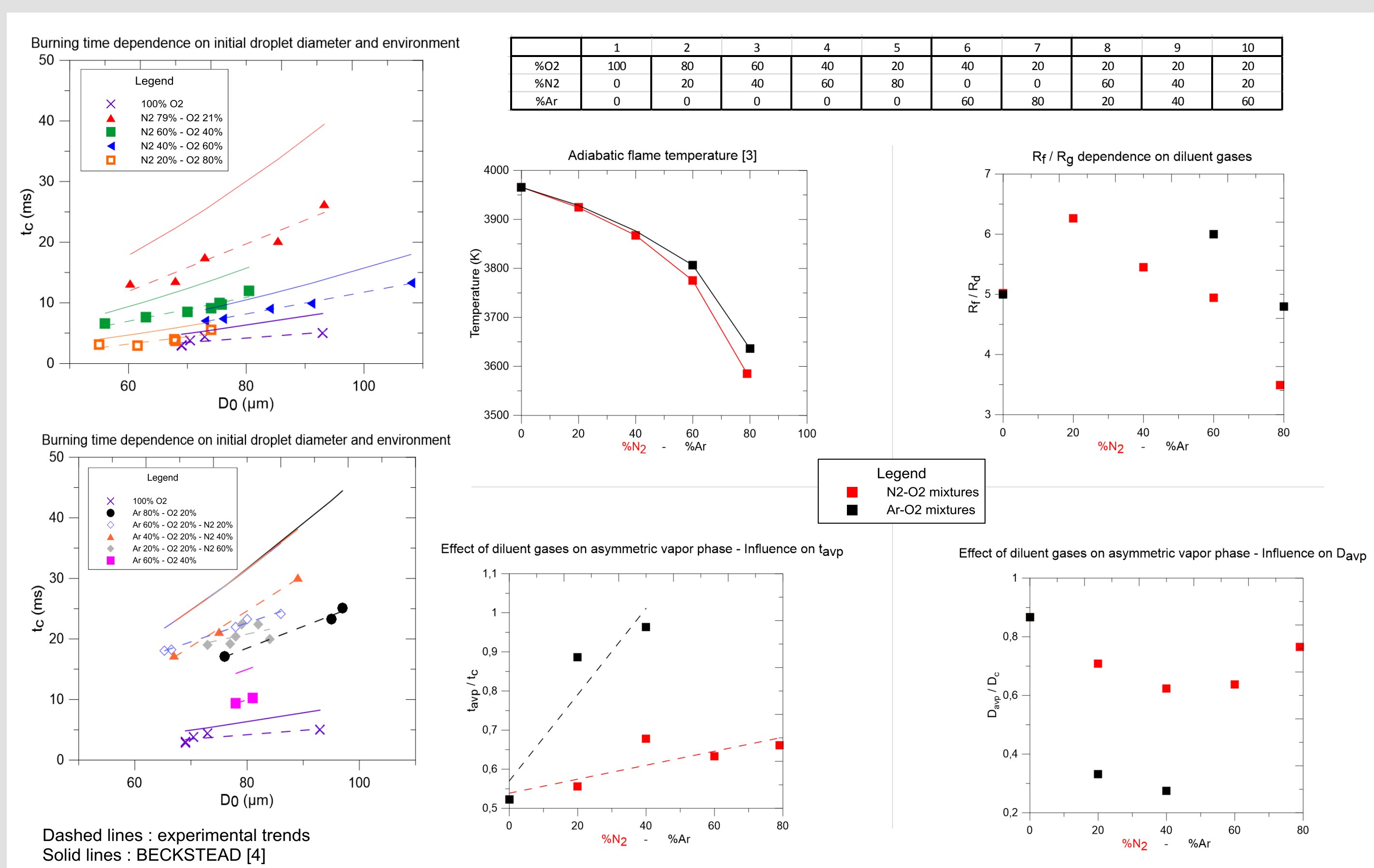

- Varying diluent environment, both in composition and proportion, modify combustion times and related parameters of asymmetric vapor phase.
- N₂ and Ar species have similar influences on combustion dynamic but N₂ has a more considerable effect, favoring the apparition of asymmetric vapor phase in comparison with Ar.

Future works

- Further investigations to understand and quantify the occurrence of asymmetric phase and its influence on burning parameters varying surrounding composition and pressure.
- Determine correlations between burning time and initial diameter based on regression ratio estimated by image processing.
- Analyze combustion of aluminum particles in CO₂, CO, H₂O vapor and mixtures.

References :

- [1] Legrand B., Marion M., Chauveau C., Gökalp I., Shafirovich E. Ignition and combustion of levitated magnesium and aluminum particles in carbon dioxide. Combustion Science and Technology, 165 (1), 151-174, (2001).
- [2] DREIZIN, Edward L. Experimental study of stages in aluminium particle combustion in air. Combustion and Flame, 1996, vol. 105, no 4, p. 541-556.
- [3] NASA, CEA. Chemical Equilibrium with Applications. Software Package
- [4] BECKSTEAD, M. W. A summary of aluminum combustion. Brigham Young Univ Provo Ut, 2004.



Scan me