



HAL
open science

On the design and testing of Airtightness Modifier dedicated to the TIPEE IEQ House

Maxime Paquet, Marcelli Martin, Aline Bachelet, Ekaterina Obukhova, Emma Calamote, Florian Lae, Jérôme Nicolle, Marc O. Abadie

► **To cite this version:**

Maxime Paquet, Marcelli Martin, Aline Bachelet, Ekaterina Obukhova, Emma Calamote, et al.. On the design and testing of Airtightness Modifier dedicated to the TIPEE IEQ House. 38th AIVC Conference "Ventilating healthy low-energy buildings", Sep 2017, Nottingham, United Kingdom. <hal-01840885>

HAL Id: hal-01840885

<https://hal.science/hal-01840885v1>

Submitted on 20 May 2025

HAL is a multi-disciplinary open access archive for the deposit and dissemination of scientific research documents, whether they are published or not. The documents may come from teaching and research institutions in France or abroad, or from public or private research centers.

L'archive ouverte pluridisciplinaire **HAL**, est destinée au dépôt et à la diffusion de documents scientifiques de niveau recherche, publiés ou non, émanant des établissements d'enseignement et de recherche français ou étrangers, des laboratoires publics ou privés.



HAL Authorization

On the design and testing of Airtightness Modifier dedicated to the TIPEE IEQ House

Maxime Paquet¹, Marcelli Martin¹, Aline Bachelet¹, Ekaterina Obukhova¹,
Emma Calamote¹, Florian Lae¹, Jérôme Nicolle² and Marc Abadie^{*1}

*1 University of La Rochelle
23 avenue Albert Einstein
La Rochelle, France*

*2 TIPEE platform
8 Rue Isabelle Autissiers
Lagord, France*

**Corresponding author: mabadie@univ-lr.fr*

ABSTRACT

This paper aims to present the elaboration of a device able to modify the airtightness of a test House. This project has been conducted with three Master student groups in the framework of their research projects from 2015 to 2017. The TIPEE IEQ test House, comprising of two floors and eight rooms, is dedicated to the study of Indoor Air Quality (IAQ), thermal comfort and energy consumption. Its envelope has been designed to reach an airtightness target slightly lower than the French Energy Efficiency Standard RT2012 requirement for dwellings i.e. $Q_{4 Pa}$ value equals to $0.5 \text{ m}^3/\text{h.m}^2$ ($n_{50} = 1.2 \text{ ACH}$). The role of the new device, called Building Airtightness Modifier (BAM) in this paper, is to allow the experimental researchers to adapt the envelope airtightness of the test house (or part of it) in a gradually fashion from the lower value of 0.5 to about $2 \text{ m}^3/\text{h.m}^2$. The main objective here is to evaluate the influence of envelope airtightness on IAQ and heating/cooling/ventilation system efficiency. In this paper, the description of the TIPEE IEQ test House is given in a first part. Then, the design process of the BAM is presented. Tests performed by the students on both experimental bench and in situ show a good agreement with the initial design objectives.

KEYWORDS

Building Airtightness Modifier, airflow rate, test house, measurement

1 INTRODUCTION

The Building Airtightness Modifier (BAM) were designed to modify the test house airtightness within a range representative of the French residential building stock in order to simulate any type of building envelope. Two main objectives have been considered:

1. To vary the airflow rate across the building envelope at standard pressure indoor to outdoor pressure difference from its initial low value $Q_{4Pa}=0.5 \text{ m}^3/\text{h.m}^2$ ($n_{50} = 1.2 \text{ ACH}$) to a upper value encountered in France.
2. To keep the nature of the airflow through the building envelope representative of the reality i.e. the value of the airflow exponent n .

The first objective helps determining the maximum airflow through one single BAM. Figure 1 presents the evolution of $Q_{4 Pa}$ in France with time. The airtightness range corresponds to 0.5 to $2.0 \text{ m}^3/\text{h.m}^2$. The BAM have then to provide $1.5 \text{ m}^3/\text{h.m}^2$ i.e. **a total airflow of $23.4 \text{ m}^3/(\text{h.BAM})$ under 4 Pa-pressure gradient** (considering a total of 16 BAM).

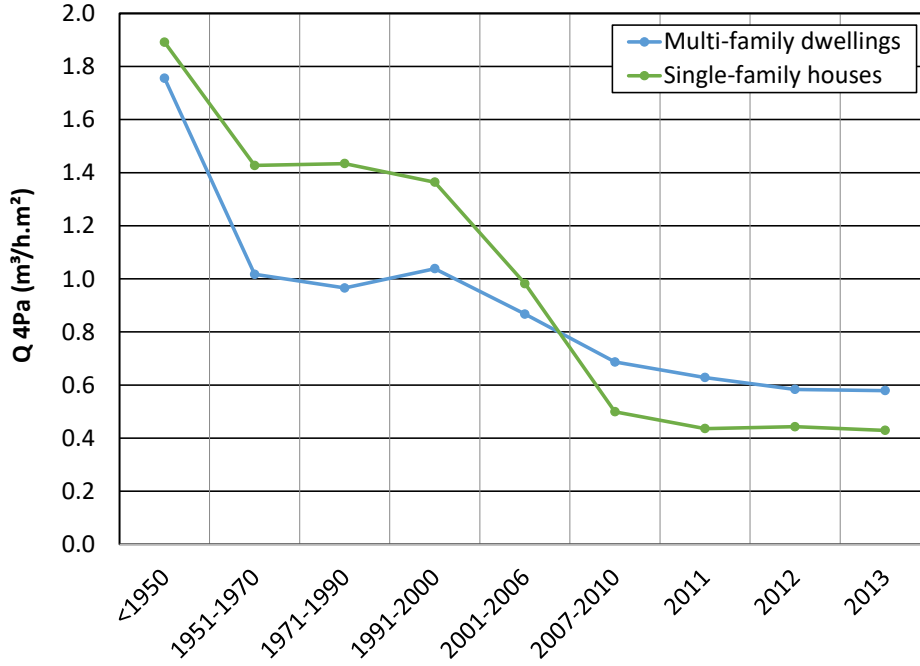

Figure 1: Evolution of the airtightness envelope measurements and their results for residential buildings in France (from Bailly et al., 2015).

To fulfil the second objective, the airflow exponent n has to be defined. The airflow rate across the building envelope, Q_{env} (m³/h), is calculated from the difference between the indoor and outdoor pressure, Δp (Pa) using the following power law equation:

$$Q_{env} = C_{env} \times \Delta p^n \quad (1)$$

where C_{env} is the airflow coefficient (m³/(h.Paⁿ)) and n , the airflow exponent (-) that characterises the flow regime, with values ranging from 0.5 for turbulent flow to 1 for laminar flow (EN ISO 9972:2015).

The study of airflow exponent n identifies the type of air pathway, which helps characterise the usual infiltration pathways. The majority of airflow exponent for leakage openings at joints or material interfaces are found to be between 0.5-0.7. On the other hand, the exponent for porous surfaces varies between 0.5 and 1 (Orme et al., 1998). A value of 0.66 is the reference adopted in countries where airtightness standards are traditionally high because air leakage pathways in residential units are dominated by developing flows in cracks such that $n = 0.67$ (Walther and Rosenthal, 2009). More recently, Walker et al. (2013) have studied the link between the measurement uncertainty and the power-law, and especially the flow exponent n . Using the Residential Diagnostics Database (about 7000 measurements), they calculated a mean value of 0.646 (standard deviation, $sd=0.057$). The values measured in countries such as Italy, 0.55–0.69 with a mean on the order of 0.60 (D’Ambrosio Alfano et al., 2012), or Spain, 0.54 to 0.64 with a median of 0.58 (Fernández-Agüera et al., 2016), are lower because n tends to be higher in leakage openings with larger flow resistance than those found in the Mediterranean area. In 2016, Bailly et al. studied the airtightness measurements of about 90,000 residential and non-residential buildings in France (2008 to 2014) and evaluated the flow exponent to 0.667 ($sd = 0.05$). The BAM have to produce an airflow nature characterized by an **exponent n of about 0.667**.

2 METHODOLOGY

2.1 Description of the TIPEE IEQ test House

This research test House has been built up in order to work on Indoor Air Quality, comfort and energy consumption in real conditions. With a surface area of 150 m², it consists of 2 levels with a kitchen/living-room, an office room and a WC located in the first level and 3 bedrooms and a bathroom in the second floor. An additional technical room is dedicated to the measurement and control systems and is completely independent from the rest of the house. The main characteristics of the test house are: low-emission internal surfaces, adaptable ventilation systems (extract or supply/extract, with or without heat recovery system), automatic control of windows opening and sunscreens and centralized energy meters. A particular effort has been made to improve the performance of the building envelope to ensure airtightness (design $Q_{4 Pa} = 0.5 \text{ m}^3/\text{h}\cdot\text{m}^2$, $n_{50} = 1.2 \text{ ACH}$). In order to artificially vary the permeability of the envelope to mimic the behaviour of older buildings (more porous building envelopes and/or natural ventilation), cylindrical holes (23 cm in diameter) have been uniformly distributed over the house envelope (Figure 2). These holes are reservations for the BAM studied in this paper and described in the next section.



Figure 2: BAM locations in the test house (left: outside view; right: inside view).

2.2 Design of the BAM

The technical constraints for the design of the BAM were initially:

1. Total airflow rate of 23.4 m³/h under 4 Pa-pressure gradient for each BAM,
2. External dimensions: diameter $D = 20\text{cm}$ and length $L = 35\text{cm}$.

Two different approaches have been considered: multiple circular ducts and rectangular cracks (Figure 3). Pressure drop across the BAM have been calculated with classic approach (friction + local losses) for the first configuration. The correlation of Baker et al. (1987) has been used for the rectangular cracks. Figure 4 presents the characteristic curves of these two BAM designs (called “initial” in Figure 4). In addition to the airflow rate at 4 Pa (Target), the BAM should also produce airflow of the same nature of real envelope i.e. with an exponent n of about 0.67. As a consequence, the circular configuration with $n = 0.52$ has been rejected. Note that the rejection of this configuration has also been motivated for technical building complexity and maintenance for cleaning. The rectangular cracks configuration has been adopted. The initial design suffers some modifications because of changes in allowable spaces for the cracks so that their widths had to be shortened. The final design includes 8 slots instead of 4; its characteristic curve and its dimensions are presented in Figure 4 and 5, respectively.

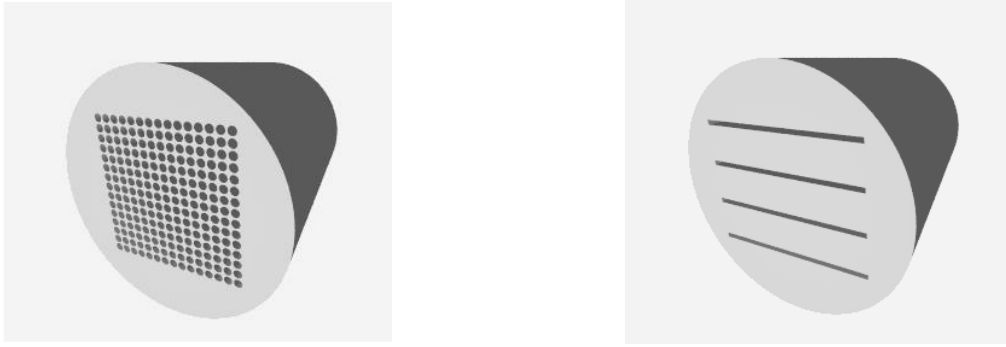

Figure 3: Initial design (left: circular ducts; right: rectangle cracks).

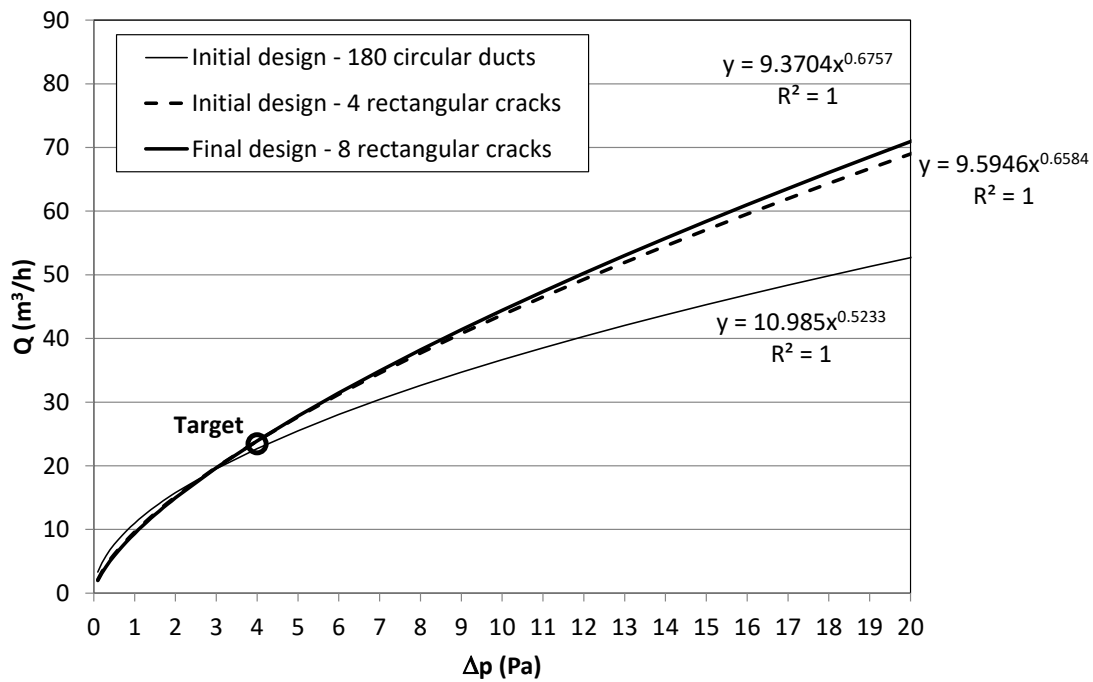

Figure 4: Characteristic curves of different BAM designs.

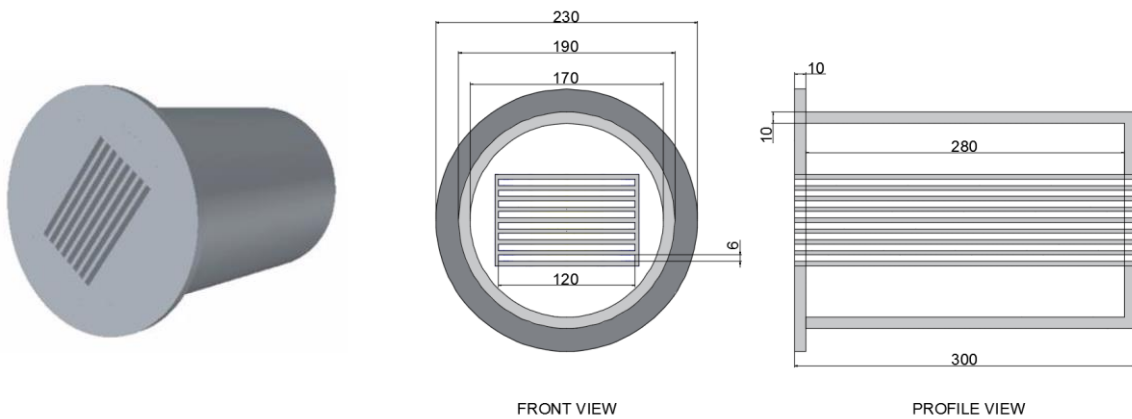

Figure 5: Final design (dimensions are in mm).

3 RESULTS AND DISCUSSION

3.1 Testing on the experimental bench

The prototype has been first tested in the laboratory. The main parts of the experimental bench are: a variable speed fan equipped with an iris diaphragm to measure the airflow rate, a circular duct (D = 20 cm, L = 3 m), a static pressure point at 1 m from the duct end and the BAM prototype (Figure 6).

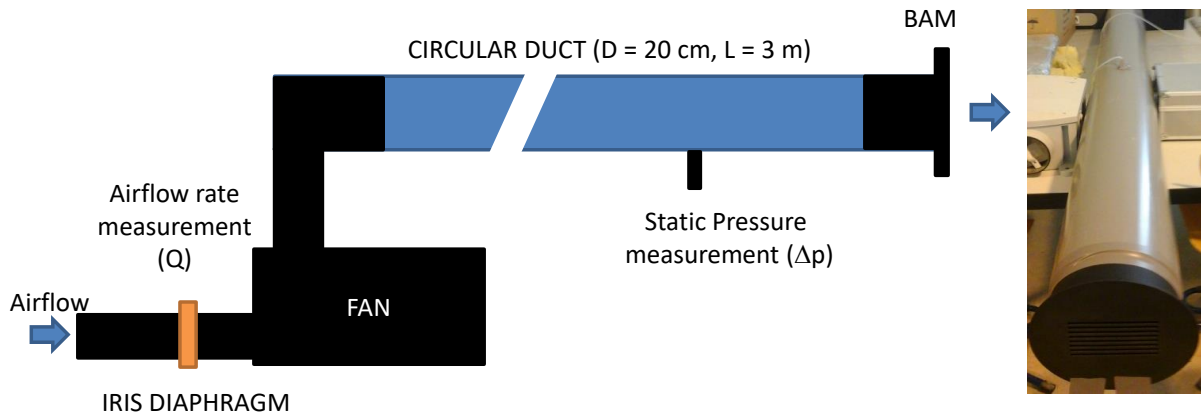

Figure 6: Experimental set-up.

The test consisted in measuring the airflow rate according to the pressure gradient around the BAM from 10 to 70 Pa with 10 Pa increment. The results of 3 validated tests are presented in Figure 7. The repeatability of the tests is positive with differences lower than 3 m³/h. On the whole, the airflow rates are lower than expected. However, the airflow rate target at 4 Pa is only 10% lower than the design one; this will only affect the highest envelope permeability that can be adjusted in the test House (1.4 instead of 1.5 m³/h.m²). Also, the nature of the airflow through the envelope will be slightly more turbulent than the expected one (0.59 instead 0.667).

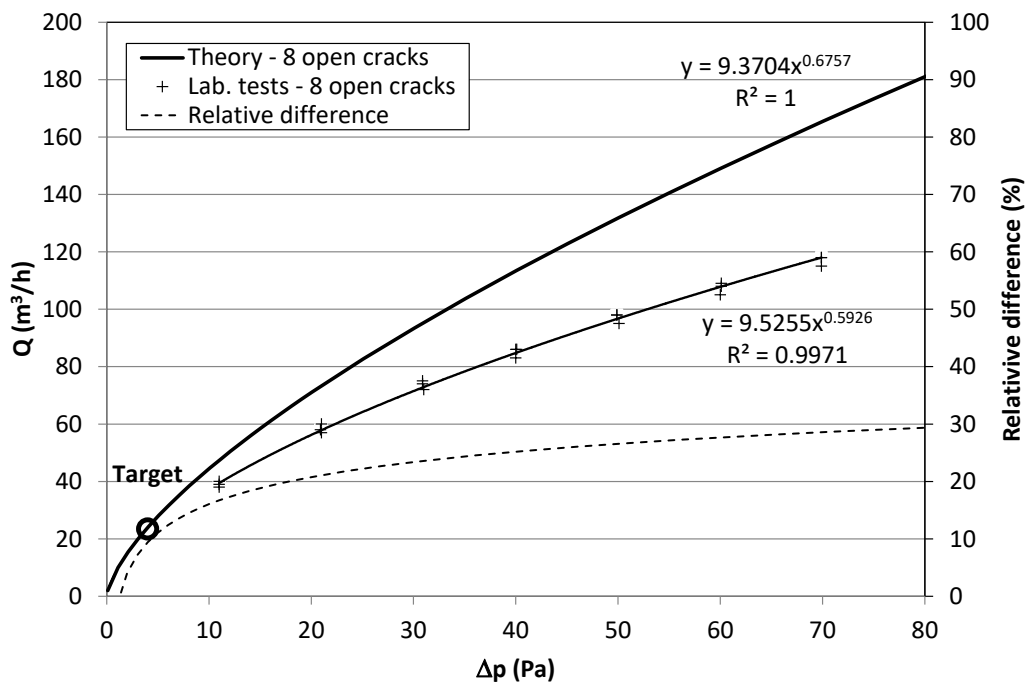

Figure 7: BAM characteristic curves obtained by measurement in the laboratory.

3.2 Testing in the test House

In a second step, the prototype has been tested in the test House by placing it in one reservation of a bedroom located in the second floor (Figure 8a). The test has been performed according to the International Standard EN ISO 9972 (2015) using a Minneapolis blower door (Figure 8b). The BAM characteristic curve has been obtained by making the difference between the measurements when the BAM was fully open (airflow through BAM + room infiltration) and test with a completely sealed BAM (room infiltration only), Figure 8c and 8d respectively.

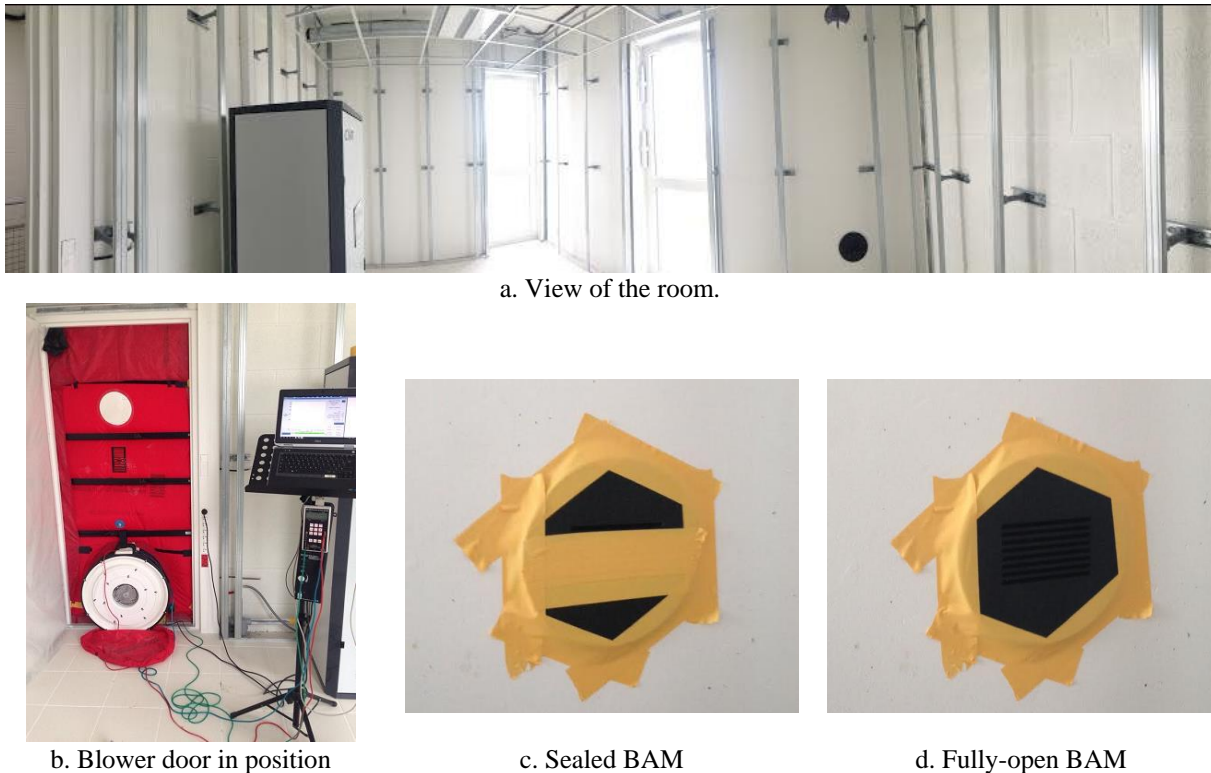

Figure 8: Experimental set-up in the test House.

Figure 9 presents the BAM characteristic curve obtained in this in-situ test. Similar deviation from the theory is observed with the same relative difference for high pressure gradient. This difference is slightly higher at 4 Pa in this case. Figure 10 presents a comparison between the curves from the lab. and in-situ tests for pressure gradient that can be encountered in real buildings (0 to 30 Pa). The difference between the two tests is essentially lower than 10% showing a good repeatability of the tests with two measurement equipment.

The difference between the theory used in the design process and the experimental results can come from limitation of the theoretical calculations. The correlation of Baker et al. (1987) has been developed for crack's length smaller than 15.2cm (the actual length of BAM is 30cm) and smooth surface (the surface presents a non-negligible roughness). In this way, pressure losses may have been underestimated by the theory. Another factor is the possible interaction among the airflows exiting from the cracks that may increase the pressure drop in relation to the theory that supposes that the cracks' airflows are independent.

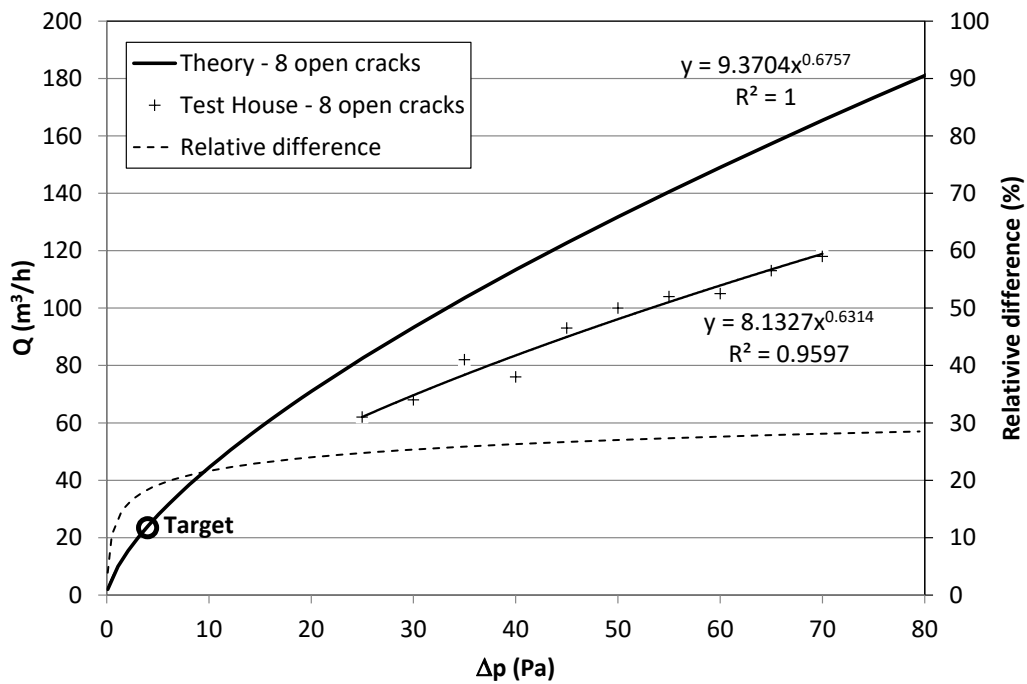

Figure 9: BAM characteristic curves obtained by in-situ measurement.

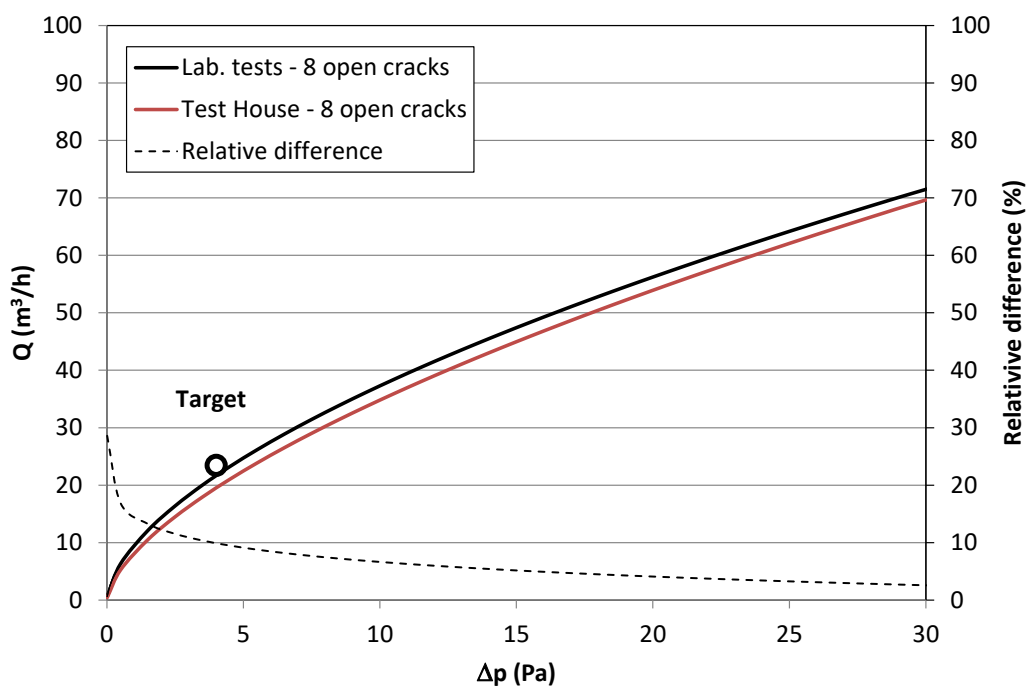

Figure 10: BAM characteristic curves obtained by lab. and in-situ measurements.

3.3 Perspectives

Perspective of this work is to allow the determination of the infiltration rate (airflow through the BAM) in the test house by simple measurement of pressure gradient at each module. In parallel of this work, pressure coefficients on the test house envelope have been measured according to wind direction in a small scale house in the wind tunnel of the Research Laboratory in Hydrodynamics, Energy and Atmospheric Environment (LHEEA). These

results with the BAM characteristic curve have been implemented into CONTAM to allow the modelling of the airflow through the envelope and in the house (Figure 11).



Figure 11: Scale model (left) and CONTAM simulation of natural ventilation through the BAM (right).

4 CONCLUSIONS

The motivations, designs and experimental testing regarding the development of the BAM for the Tipee test House have been presented in this paper. A good agreement has been found between the characteristic curves obtained experimentally in a lab bench and in-situ. On the whole, the actual airflows through the BAM are slightly lower than initially expected considering same pressure gradient. However, the BAM will still be able to represent the whole range of envelope permeability encountered in the French buildings. Moreover, those measured correlations will be used to model the airflows through the building envelope for projects related to energy consumption and IAQ.

5 ACKNOWLEDGEMENTS

Marc Abadie, associate Professor at University of La Rochelle, wants to thank all students from the Civil Engineering Department that took part of this development in the frame of their research projects during the last 3 years.

6 REFERENCES

- Bailly, A., Guyot, G., Leprince, V. (2015). 6 years of envelope airtightness measurements performed by French certified operators: analyses of about 65,000 tests. *Proceedings of the 36th AIVC – 5th TightVent – 3rd Venticool Conference*, 23-24 September, Madrid, Spain.
- Bailly, A., Guyot, G., Leprince, V. (2016). Analyses of About 90,000 Airtightness Measurements Performed in France on Residential and Non-Residential Buildings from 2008 to 2014. *Proceedings of the ASHRAE and AIVC IAQ 2016—Defining Indoor Air Quality: Policy, Standards and Best Practices*, Alexandria, Virginia, USA, September 12–14, 2016.
- Baker, P.H., Sharples, S., Ward, I.C. (1987). Airflow Through Cracks, *Building and Environment*, 22, 293–304.
- D'Ambrosio Alfano, F.R., Dell Isola, M., Ficco, G., Tassini, F. (2012). Experimental analysis of airtightness in Mediterranean buildings using the fan pressurization method. *Building and Environment*, 53, 16–25.

EN ISO 9972:2015. *Thermal performance of buildings – Determination of air permeability of buildings – Fan pressurization method*. (ISO 9972:1996, modified).

Fernández-Agüera, J., Domínguez-Amarillo, S., José Sendra, J., Suárez, R. (2016). An approach to modelling envelope airtightness in multi-family social housing in Mediterranean Europe based on the situation in Spain. *Energy and Buildings*, 128, 236-253,

Orme, M., Liddament, M., Wilson, A. (1998). Numerical data for Air Infiltration and Natural Ventilation Calculations. *AIVC Technical Note 44*, 108p.

Walker, I.S., Sherman, M.H., Joh, J. and Chan, W. R. (2013). Applying Large Datasets to Developing a Better Understanding of Air Leakage Measurement in Homes. *Journal of Ventilation*. March.

Walther, W., Rosenthal, B. (2009). Airtightness Testing of Large and Multi-family Buildings in an Energy Performance Regulation Context. *Information Paper no P165*, EPBD buildings platform.