



HAL
open science

The "Coffee-flux collaborative observatory": measuring and modeling carbon, nutrients, water and sediment Ecosystem services in a coffee agroforestry watershed (Costa Rica)

Olivier Roupsard, Karel van den Meersche, Clementine Alline, Bruno Rapidel, Jacques Avelino, Fédérico Gomez-Delgado, Fabien Charbonnier, Laura Benegas, Kristen Welsh, Rintaro Kinoshita, et al.

► To cite this version:

Olivier Roupsard, Karel van den Meersche, Clementine Alline, Bruno Rapidel, Jacques Avelino, et al.. The "Coffee-flux collaborative observatory": measuring and modeling carbon, nutrients, water and sediment Ecosystem services in a coffee agroforestry watershed (Costa Rica). 2016, 23 p. hal-01837379

HAL Id: hal-01837379

<https://hal.science/hal-01837379>

Submitted on 5 Jun 2020

HAL is a multi-disciplinary open access archive for the deposit and dissemination of scientific research documents, whether they are published or not. The documents may come from teaching and research institutions in France or abroad, or from public or private research centers.

L'archive ouverte pluridisciplinaire **HAL**, est destinée au dépôt et à la diffusion de documents scientifiques de niveau recherche, publiés ou non, émanant des établissements d'enseignement et de recherche français ou étrangers, des laboratoires publics ou privés.



The “Coffee-Flux Collaborative Observatory”: measuring and modeling carbon, nutrients, water and sediment Ecosystem Services in a coffee agroforestry watershed (Costa Rica).

O. Roupsard^{1,2,8}, K. Van den Meersche^{1,2,8}, C. Allinne^{1,6,8}, B. Rapidel^{1,6,8}, J. Avelino^{2,8,12}, F. Gómez-Delgado^{1,4,8,23}, F. Charbonnier^{1,2,8,28}, L. Benegas^{2,13}, K. Welsh^{2,11}, R. Kinoshita⁹, Remi Vezy²⁵, L. Audebert²⁴, E. Defrenet¹⁴, A. Deffner¹⁵, J. Nespoulous¹⁸, L. Jarri¹⁵, E. Khac¹⁶, A. Cambou¹⁹, J.P. Perez Molina^{2,26,15}, F. Guidat¹⁹, F. Raçon¹⁵, M. Soma¹⁶, C. Mages³¹, I. Prieto²⁰, D. Picart⁷, Elias de Melo Virginio Filho², S. Taugourdeau¹, R. Moussa³, Y. Le Bissonnais³, R. Sánchez-Murillo²⁷, R., C. Jourdan¹, G. Le Maire¹, J-M. Harmand¹, J. Dautat¹⁰, A. Albrecht¹, T. Chevallier¹, C. Roumet²⁰, A. Stokes¹⁰, J.-M. Bonnefond⁷, L. Vierling^{11,2}, J. Eitel¹¹, E. Dreyer¹⁷, Laurent Saint-Andre^{1,29}, Anders Malmer³⁰, D. Loustau⁷, M. Isaac²², A. Martin²², A. Priemé³¹, B. Elberling³¹, M. Madsen³¹, A. Robelo⁵, D. Robelo⁵, G. Ramirez⁵, M. Jara⁵, A. Perez², A. Barquero⁵, C. Rivera Wilson², M. Navarro^{1,2}, P. Vaast¹

¹UMR Eco&Sols, F-34060 Montpellier– France

²CATIE, 7170 Turrialba– Costa Rica

³INRA-ENSAM-UMR Lisah – France

⁴ICE (Costa Rica Institute of Electricity) – Costa Rica

⁵Hacienda Aquiares – Costa Rica

⁶UMR System, F-34060 Montpellier – France

⁷UMR ISPA, Bordeaux – France

⁸PCP Agroforestry MesoAmerica: Pôle de Compétences en Partenariat

⁹Cornell University-USA

¹⁰UMR AMAP, F-34060 Montpellier– France

¹¹University of Idaho–USA

¹²UPR Bioagresseurs de pérennes, CIRAD, Montpellier F-34398, France

¹³Swedish University of Agricultural Sciences (SLU)

¹⁴Agrocampus Ouest, Rennes, France

¹⁵Supagro, Montpellier, France

¹⁶AgroParisTech, France

¹⁷UMR EEF, INRA-Nancy, France

¹⁸U. Savoie, France

¹⁹ENSAIA, Nancy-France

²⁰CNRS, CEFE UMR 5175, 34293, Montpellier Cedex 5, France

²²Department of Physical and Environmental Sciences, Center for Critical Development Studies, University of Toronto Scarborough, Canada

²³World Meteorological Organization (WMO-Costa Rica)

²⁴U. Nancy I-France

²⁵U. Bordeaux-France

²⁶U. Viçosa-Brazil

²⁷UNA-Stable Isotope Research Group: National University of Costa Rica

²⁹UR BEF, INRA-Nancy, France

³⁰SLU, SWEDEN

³¹U. Copenhagen



Photo 1: Coffee-Flux experimental watershed: arabica coffee agroforestry watershed in the Aquiares farm (Costa Rica), with *Erythrina poeppigiana* shade tree. Photo Nils Roar.

Coffee is one of the world's largest agricultural export by value (FAO, 2011, Pendergrast, 2009). Costa Rica declared its ambition to become the first C-Neutral country in 2021 and will lead the development of NAMA-Café and C-Neutral coffee certification. The Coffee-Flux experimental site is unique to study simultaneously carbon, water, sediment and nutrient ecosystem services.

Aims and Philosophy of the CoffeeFlux¹ Collaborative Platform

The aim of Coffee-Flux is to assess carbon, nutrients, water and sediment Ecosystem Services (ES) at the scale of a coffee agroforestry watershed. Observation, experimentation, modelling and remote-sensing are combined, collecting data and calibrating models locally, then upscaling to larger regions. The project has been running continuously since 2009, in order to encompass seasonal and inter-annual fluctuations of coffee productivity and ecosystem services.

Coffee-flux is a platform where collaborative research on coffee agroforestry is promoted: data are being shared between collaborators and positive interactions are enhanced. The philosophy is to concentrate several investigations on one specific site and for several years, to share a useful common experimental database, to develop modelling and to publish results in highly-ranked scientific journals. Applied research is also highly encouraged (e.g. C-Neutral certification, NAMA, Agronomy, etc.). Coffee-Flux benefits from infrastructure, easy access from CATIE² and very good security, ready to welcome complementary scientific investigations and collaborations. The project is wide open to complementary projects, scientists and of course to students. The core data base is for sharing.

Sponsors-Networks- Flowchart

Coffee-flux was launched in December 2009 in Costa Rica by Cirad³, CATIE, PCP⁴ and the AQUIARES far⁵. First, it was a sub-project of CAFNET⁶ (EuropAid/121998/C/G): “Connecting, enhancing and sustaining environmental services and market values of coffee agroforestry in Central America, East Africa and India”. Coffee-Flux is a contributor of FLUXNET⁷ and became an **Observatory** within the European and french SOERE F-ORE-T⁸ network in early 2011. It is fueled by projects and delivers products to Networks and Instruments.

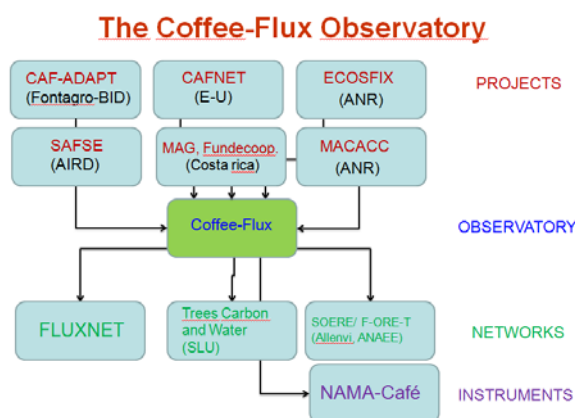

Site and infrastructure description

A 1 km² coffee watershed, homogeneously shaded with tall *Erythrina poeppigiana* was selected in AQUIARES, one of the largest coffee farms of the country, “Rainforest AllianceTM” certified, located on the slopes of the Turrialba volcano, ranging in elevation from 1,020 up to 1,280 m.a.s.l., strongly influenced by the climatic conditions of the Caribbean hillside, and without strong dry spell. The

¹ CoffeeFlux: <http://www6.montpellier.inra.fr/ecosols/Recherche/Les-projets/CoffeeFlux>

² CATIE : Centro Agronómico Tropical de Investigación y Enseñanza: <http://www.catie.ac.cr/>

³ CIRAD : <http://www.cirad.fr/>

⁴ PCP «Agroforesterie à base de cultures pérennes en Amérique Centrale» : <http://www.pcp-agroforestry.org/>

⁵ Hacienda AQUIARES : http://auction.stoneworks.com/includes/crq2004/aquiaries_brochure.html

⁶ CAFNET : http://www.catie.ac.cr/BancoMedios/Documentos%20PDF/cafnet_carbon_sequestration_mela.pdf

⁷ FLUXNET (Global Network of Micrometeorological Tower Sites) : <http://daac.ornl.gov/FLUXNET/>

⁸ Observatoire SOERE/F-ORE-T : http://www.allenvi.fr/?page_id=768

watershed is instrumented with automatic flumes, pluviometers, soil moisture probes, piezometers, turbidimeters, sapflow and eddy-covariance tower (for H₂O and CO₂ gas fluxes).

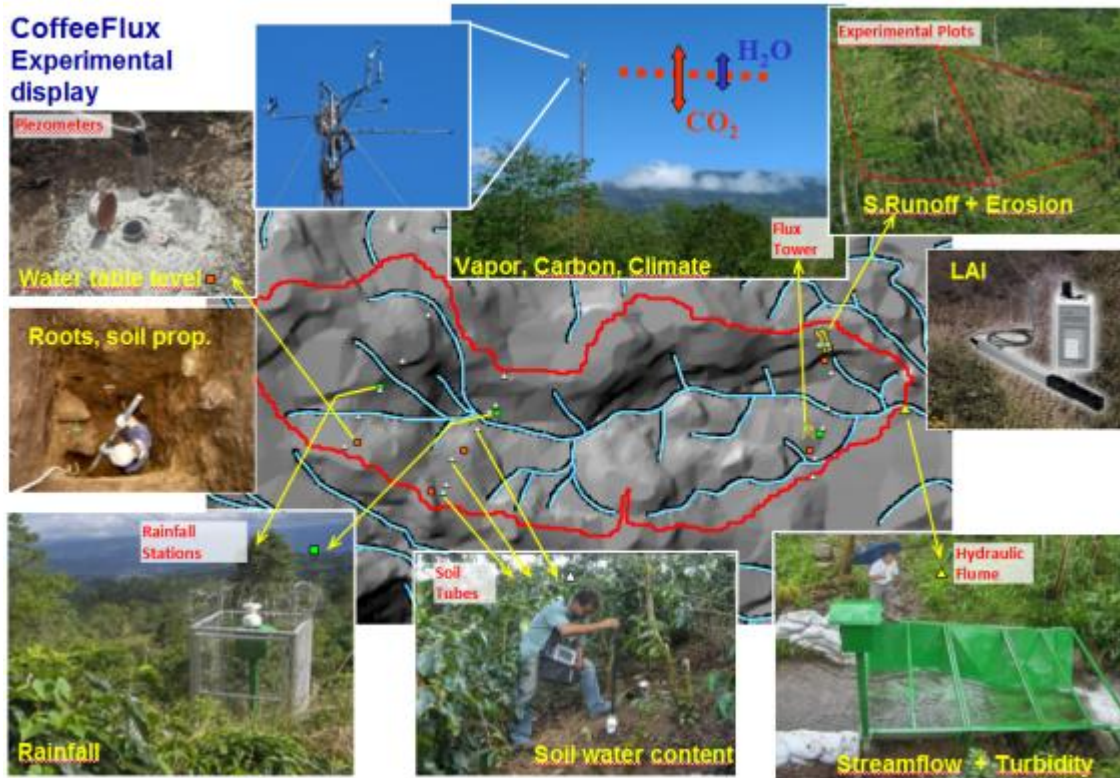

Photo. 2: The Coffee-Flux experimental display.

Monitoring Ecosystem Services

Hydrological service: Coffee-Flux is monitoring and modelling the water balance partitioning (rainfall, interception, superficial runoff, infiltration, sapflow, soil water balance, evapotranspiration, aquifer fluctuations and total streamflow), and the sediment yield from plot to watershed. One model was developed (Hydro-SVAT: Gómez-Delgado et al., 2011). Also $\delta^{18}\text{O}/\delta\text{D}$ isotopic tracing experiments are underway (collaboration with UNA, Ricardo Sánchez-Murillo et al., 2015). 1 PhD thesis is achieved (Gómez-Delgado F., 2010), two are in progress (Benegas L.; Welsch K.) and 2 postgraduate fellowships achieved (Kinoshita, 2009; Deffner A.).

Carbon service: Coffee-Flux is monitoring the leaf area index (LAI) using field and remote sensing techniques (High Resolution Multispectral Images; MODIS), the Net Primary Productivity (NPP: tree + coffee growth and mortality) above and below-ground (minirhizotrons, rhizotrons), the Gross Primary Productivity or (GPP = ecosystem photosynthesis), the ecosystem + soil respiration, the whole plant gas exchanges, the leaf gas exchanges and the Net Ecosystem Exchange (NEE) which is the ecosystem C balance, using combined eddy covariance, growth+litter monitoring and various plant chambers. The SOC, nitrogen, active C, non-crystalline clay minerals such as allophane, imogolite, ferrihydrite as well as metal-humus complexes have been surveyed, SOC and N were estimated by VISNIR and mapped (kriging) for the whole watershed (Kinoshita et al., 2015). 1 PhD is completed (Charbonnier F.), two PhD in progress (Perez Molina J.P., Vezy, R.), 6 MSc achieved (Taugourdeau S.; Audebert L.; Defrenet E.; Nespoulous, J., Khac E., Soma M.) and 2 post-graduate fellowships (Jarri, L., Cambou A., Guidat, F., Rançon, F.). One radiation absorption + photosynthesis + transpiration model is being used (MAESPA: Charbonnier et al., 2013).

Nutrient balance: Coffee-Flux is monitoring nutrient inputs, assimilation and leaching, according to distance to shade trees and within an experimental display controlling fertilization (K. Van Den Meersche). Nitrates and P are also being monitored in aquifers and streamflow (PhD of K. Welsch).

Other GHGs emissions: a N₂O & CO₂ soil flux automatic monitoring experiment was settled in February 2016 in a fertilization trial, in collaboration with U. Copenhagen; Master of Carolin Mages).

Protection against erosion: Coffee-Flux is monitoring erosion at plot scale (with trees and without trees) and sediment yield at the watershed scale (using automatic turbidimeter). Also in the PhD of Gómez-Delgado F. (2010).

Coffee pests and diseases regulation: Incidence and severity of coffee pests and diseases (including coffee leaf rust) are being monitored under shaded and full sun conditions, and compared with or without treatment (C. Allinne). Incidence is also measured in function of the fertilization level.

Effect of Shade on coffee microclimate: The CATIE Agroforestry trial (Elias de Melo) has been equipped to monitor coffee canopy temperature and microclimate according to Shade types (MSc. of Maxime Soma, PhD of Rémi Vezy).

Rainfall and streamflow

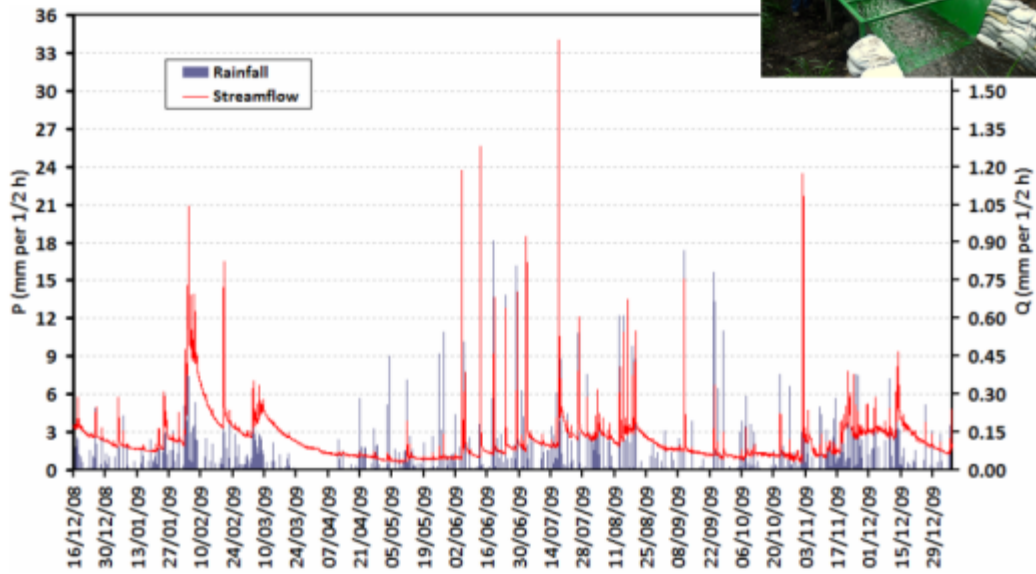

Fig. 1: The red line is the time-course of streamflow at the outlet of the Coffee-Flux watershed (automatic flume), showing a large contribution of the baseline (aquifer responding in terms of discharge and recharge) + episodic and rather low contribution of superficial runoff (peaks after rainfall events). This behaviour is typical of watersheds with large infiltration capacity, low superficial runoff and probably low laminar sediment transport.

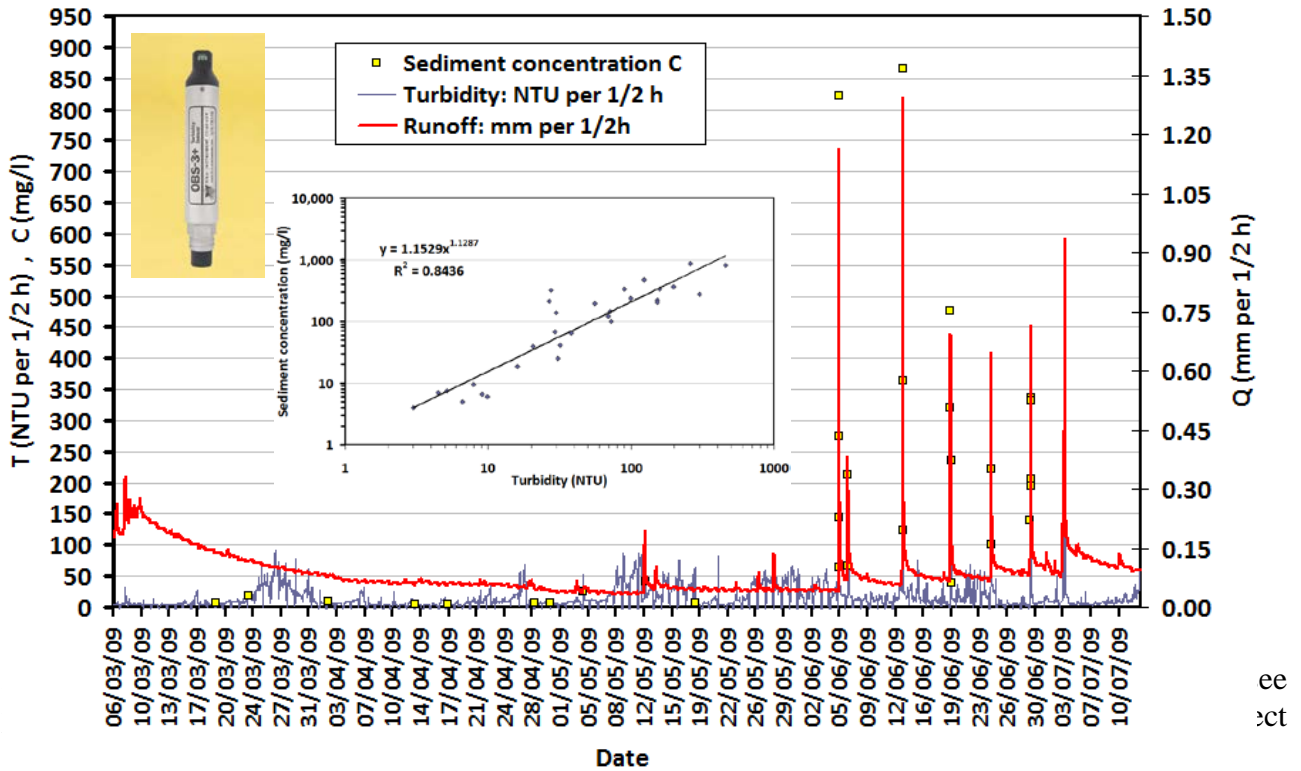

Fig. 2: Time-course of the sediment transport assessed by automatic turbidimeter (OBS-3, see photo) and bottle collection at the outlet of the Coffee-Flux watershed. The rating curve of turbidity in terms of sediment load is also given.

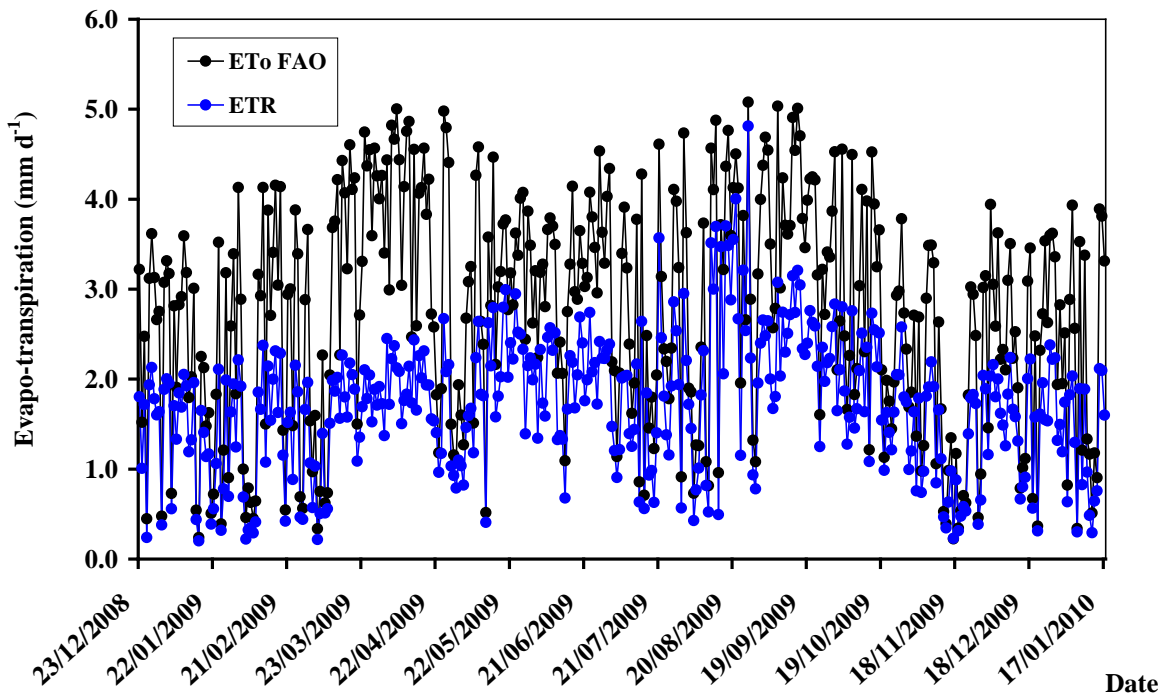

Fig. 3: Time-course of daily potential (ET_0 -Penman Monteith, FAO) and real evapo-transpiration (ETR, by eddy covariance) in the Coffee-Flux Watershed. ETR/ET_0 varies from 0.4 to 0.7, according to LAI fluctuations mainly.

Cumulative water balance

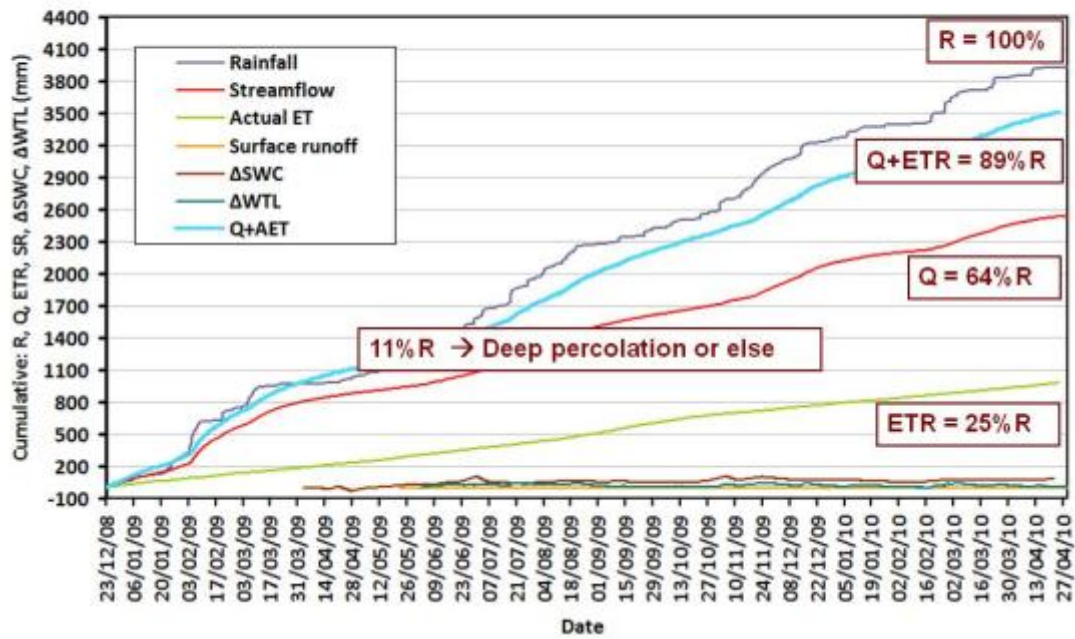

Fig. 4: Cumulative water balance of the CoffeeFlux watershed, as measured by independent methods (ETR by eddy covariance ; Q by flume).

Lumped Hydro-SVAT model

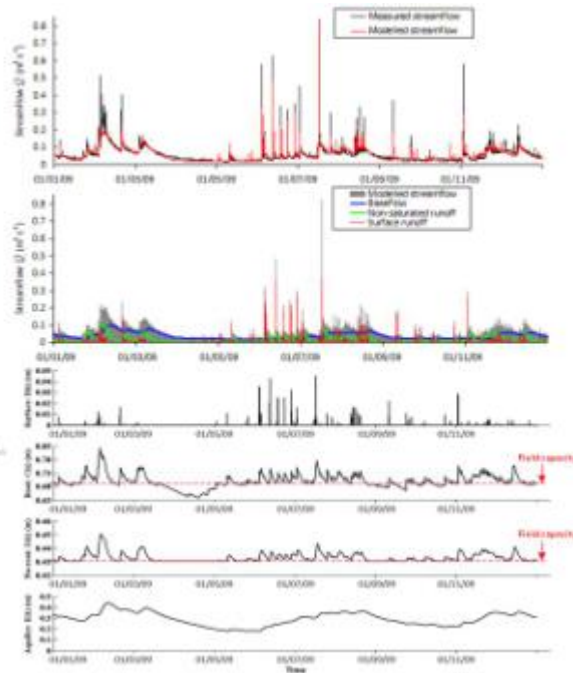
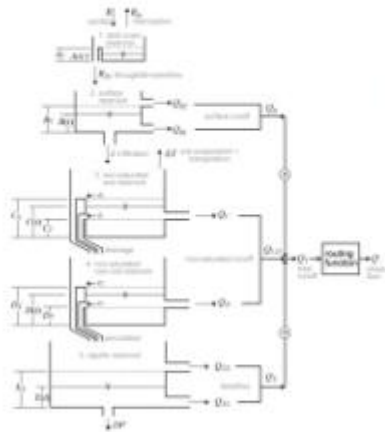

Fig. 6: Structure and simulations of the lumped Hydro-SVAT model for the water-balance partitioning of the Coffee-Flux watershed (Gómez-Delgado et al, HESS, 2011)

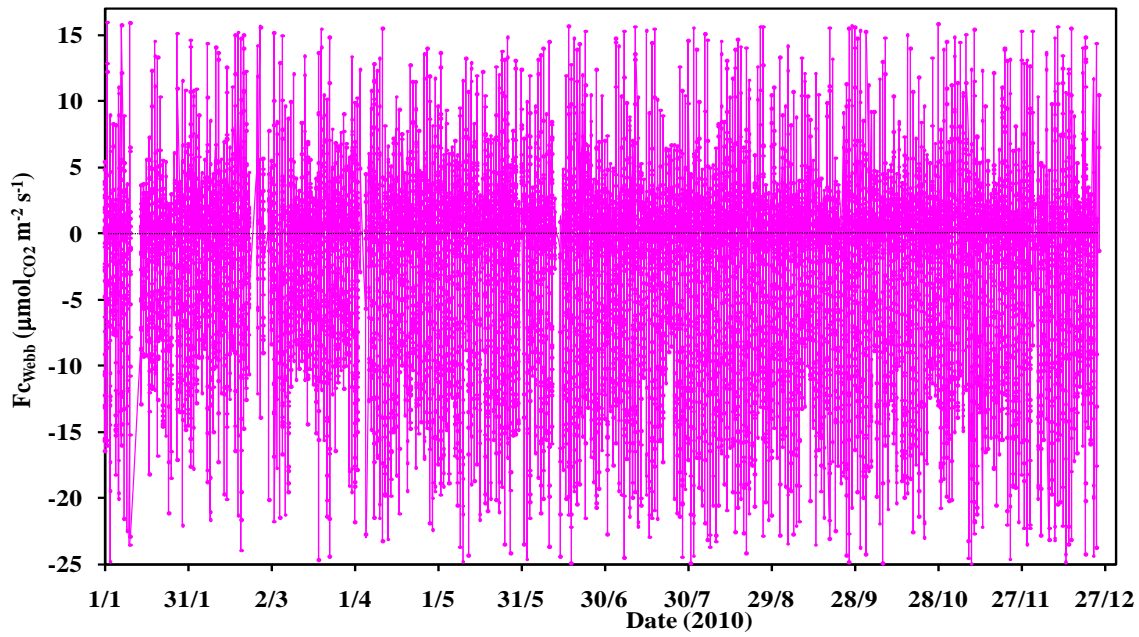

Fig. 7: Time-course of carbon net ecosystem exchange (F_c), and its partitioning into ecosystem respiration (positive values, mainly at night) and C uptake (photosynthesis + respiration, negative values). One cycle is one day, data from year 2010

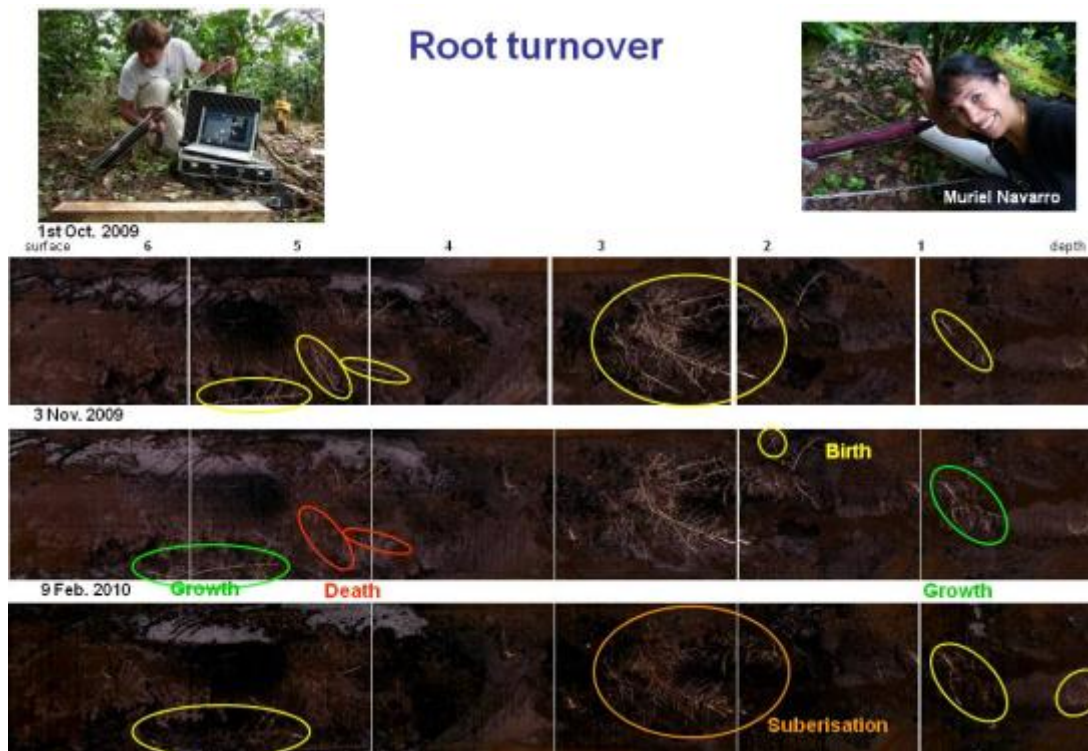
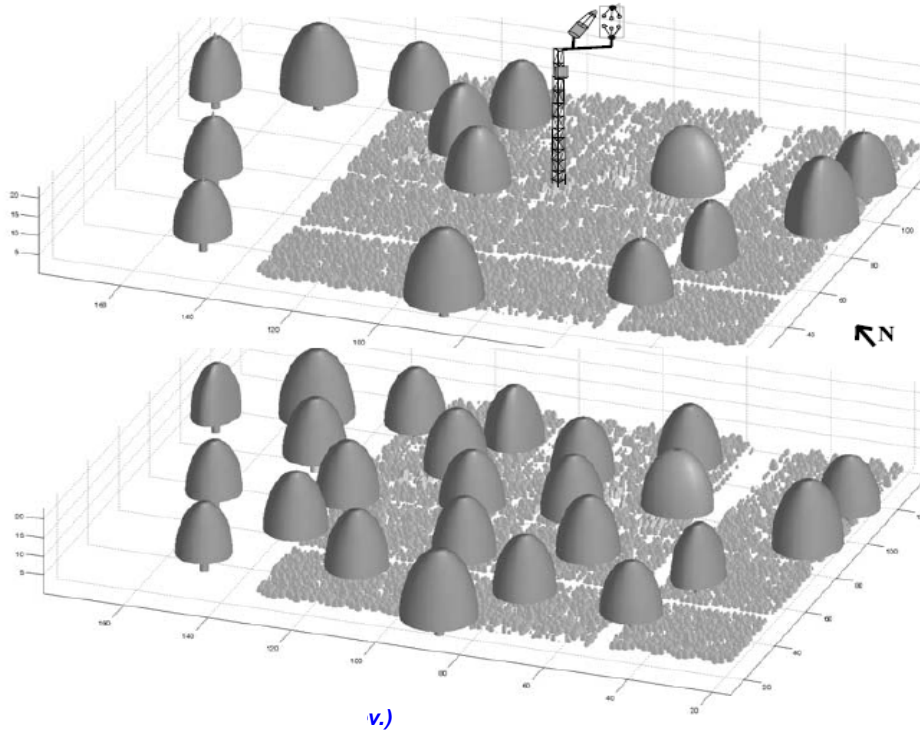

Fig. 8: Root turnover (birth, growth, mortality) assessed by minirhizotrons

Simulating intra-plot light absorption with MAESTRA



v.)

Fig. 9: Scenes for the simulation of light absorption, water and CO₂ exchanges by every plant of the plot under actual or double shade-tree density. Charbonnier et al., AFM, 2013

Simulating intra-plot light absorption with MAESTRA

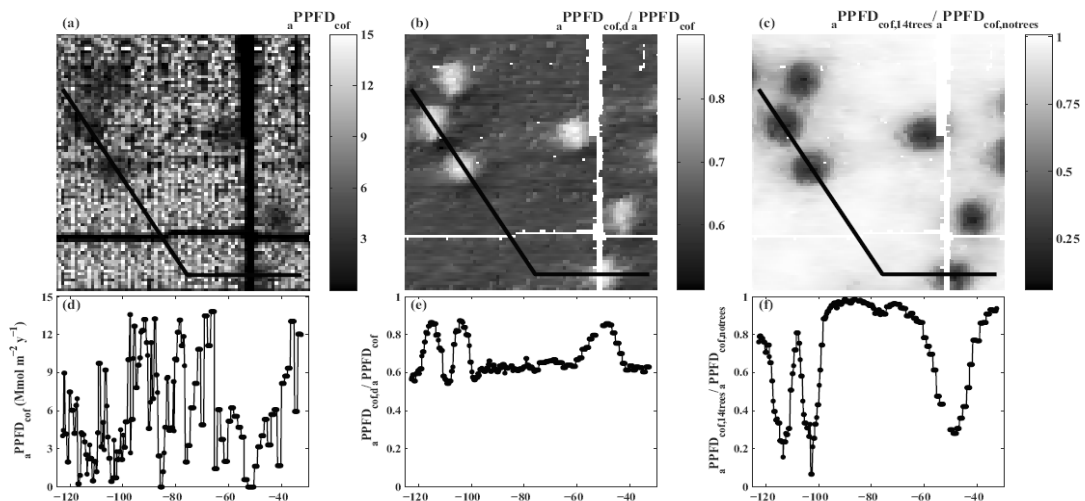

v.)

Fig. 10: Intra-plot variability for light absorption. Top views and transects for yearly absorbed PPFD by the coffee layer, relative absorbed diffuse PPFD by the coffee layer, relative absorbed by the coffee layer when shade trees are present or not. Charbonnier et al., AFM, 2013.

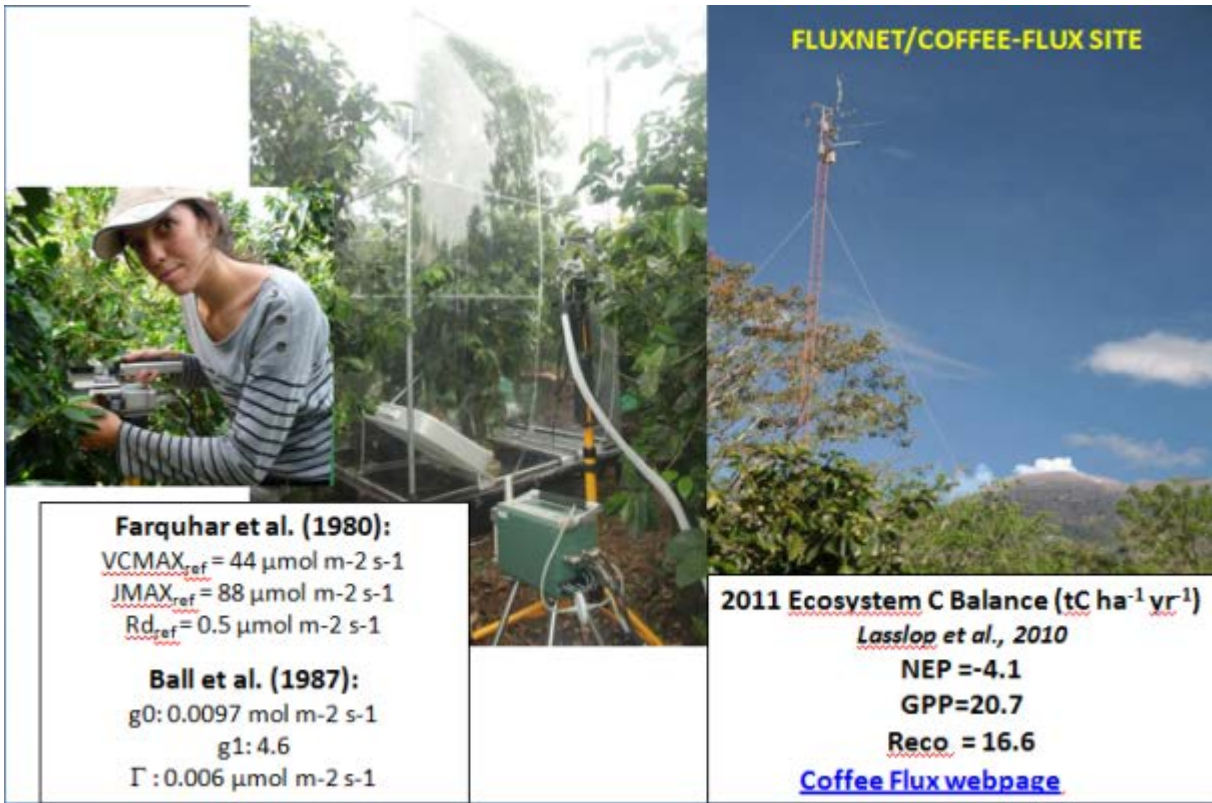

Fig. 11: Measuring photosynthesis at three scales: leaf, whole coffee-plant and ecosystem. Charbonnier et al, 2012.

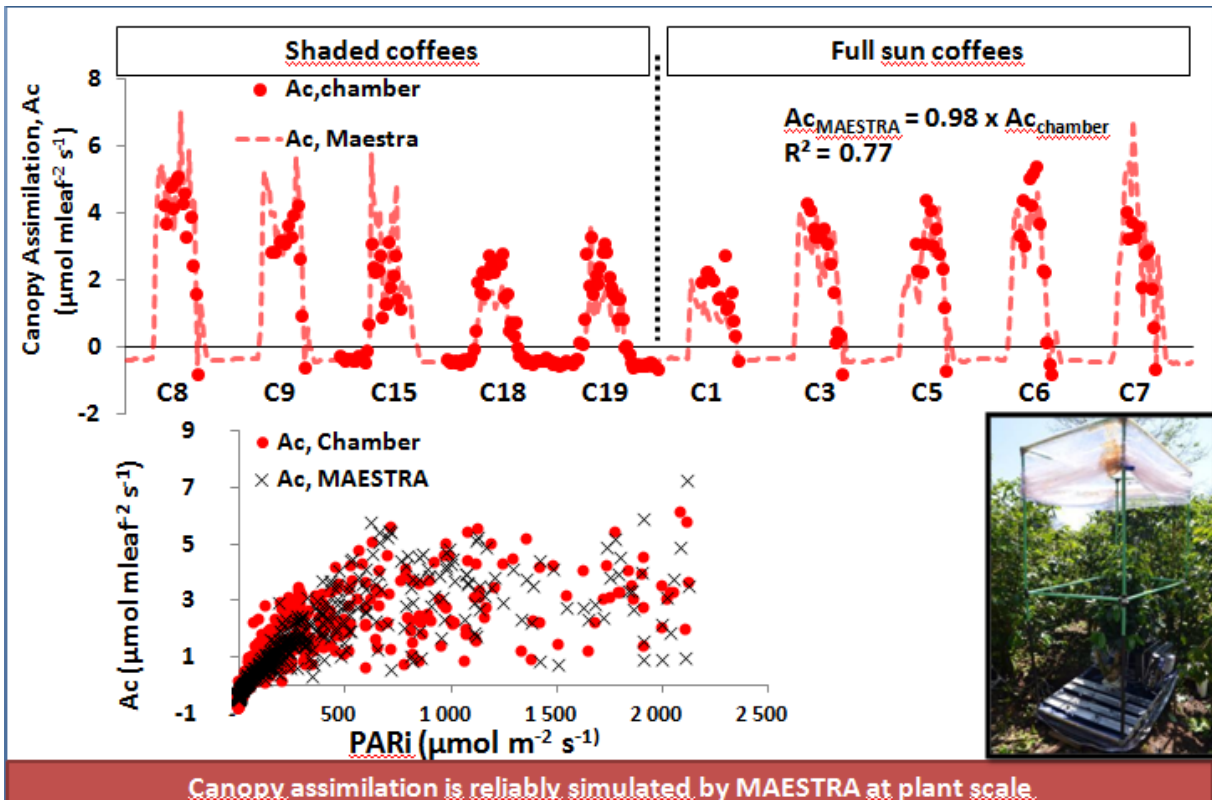

Fig. 12: Verifying photosynthesis simulated by the MAESTRA model at the whole plant –scale. Charbonnier et al, 2012.

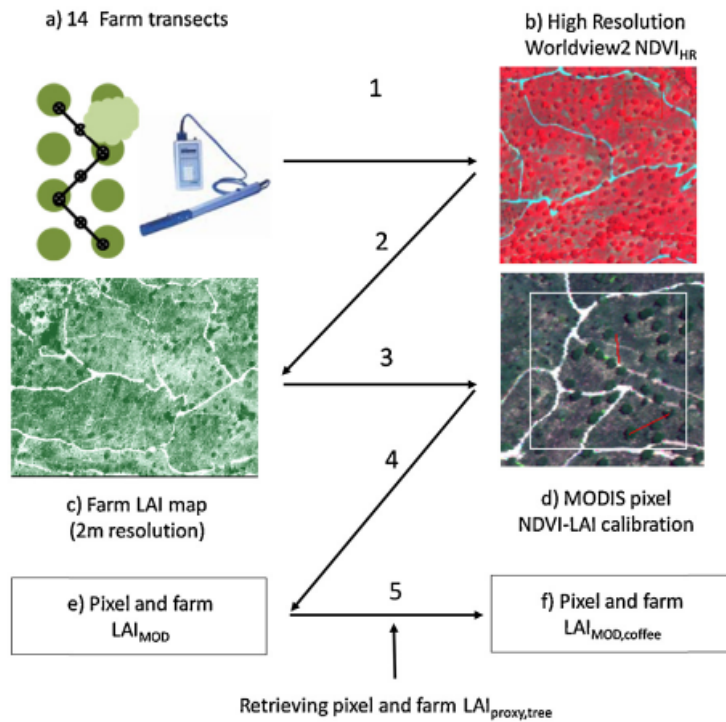

Fig. 3. Scheme for the methods used when upscaling LAI from transects to MODIS pixels and to farm: (a) 14 farm transects (see Fig. 2); (b) High resolution Worldview2 NDVI_{HR} image, calibrated using the 14 transects (step 1); (c) Farm LAI map at 2m resolution computed from step 2; (d) MODIS pixel position (white frame) used to compute the LAI_{HR} average and to calibrate the MODIS LAI-NDVI relationship at 250 m resolution from step 3; (e) computing pixel and farm LAI_{MOD} from step 4; (f) computing pixel and farm LAI_{MOD,coffee} after retrieving pixel and farm LAI_{proxy,tree}, from step 5.

Fig. 13: Methods used in Leaf Area Index assessment from plant to plot to farm. Taugourdeau et al., 2014.

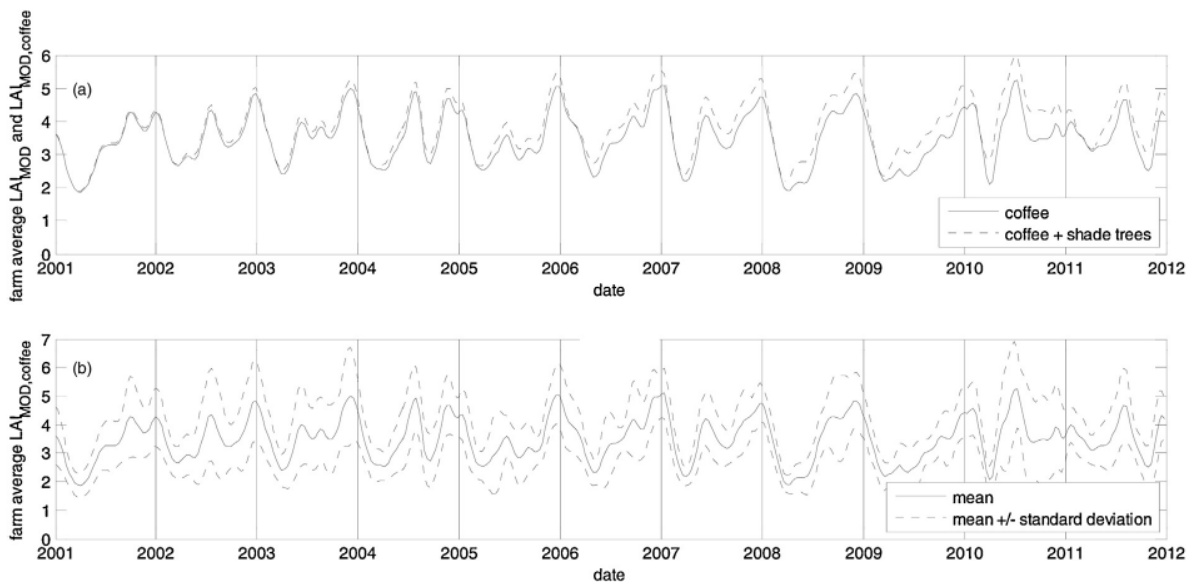

Fig. 14: Monitoring Leaf Area Index at farm scale using MODIS 2001-2012. Taugourdeau et al. AGEE, 2014.

Emisiones finales Finca Entera (beneficio + bosque + parcelas)

Inventario GEI Cafetalera Aquiares S.A				
Tipo de emisiones	Categoría de emisión	Fuente	Ton CO ₂ e	Notas
Total con biomasa (CO ₂)	Total con biomasa (CO ₂)		3 857	
Total sin biomasa (CO ₂)	Total sin biomasa (CO ₂)		1 154	
*Emisiones de CO ₂ por Biomasa son excluidas de este inventario según la norma nacional INTE ISO 12-10-06				
	Remoción CO ₂ en bosque	Inventario MINAET 2007	-221	67ha x 0.9 tC ha ⁻¹ x 44 / 12 = 221 tCO ₂ ha ⁻¹ año ⁻¹
	Remoción CO ₂ en parcelas	0.1*Hojarascas+0.1*(Biomasa subterránea no exportada)/duración del ciclo	-1 968	0.66 tC ha ⁻¹ año ⁻¹ x 673 ha x 44 / 12. Promedio 4 años 2010-2013
	TOTAL Finca	Balance de CO₂ de la Finca Entera	-1 035	

Carbono-Neutral ya (y mas...)



Un valor negativo significa Remoción!!!

22

Fig. 15: Estimating the GHG balance of the Aquiares Farm, application to C-Neutral certification. O. Roupsard dec 2014, presentation to Junta Nacional del Carbono/Costa Rica.

Conclusiones : ?Carbon-Neutralidad: una meta finita o mejor un “punto de transición hacia manejos más eficientes” ¿

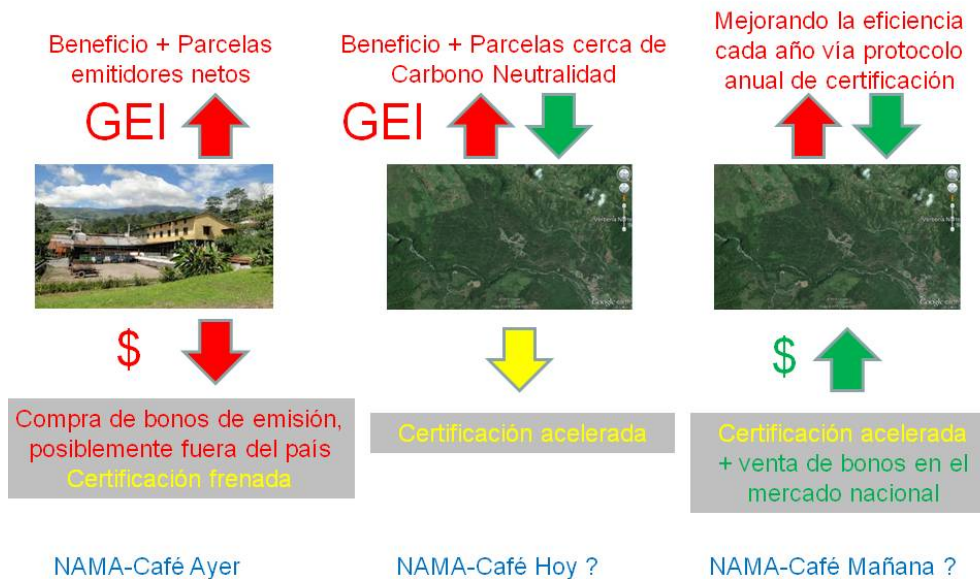

25

Fig. 16: A proposed strategy to enhance C-Neutral certification in the coffee sector. O. Roupsard dec 2014, presentation to Junta Nacional del Carbono/Costa Rica.

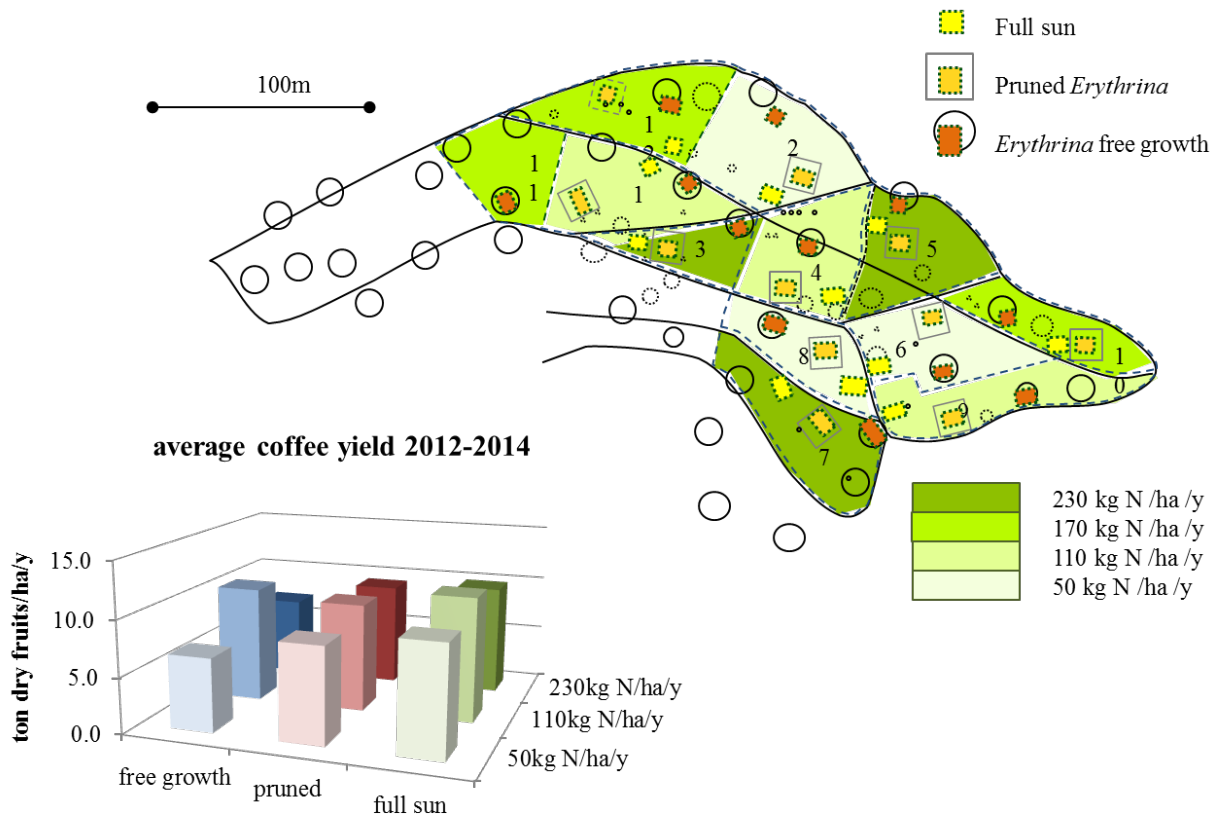

Fig. 17: Schematics and averaged yields in the fertilization/shade experiment (K. Van den Meersche et al.).

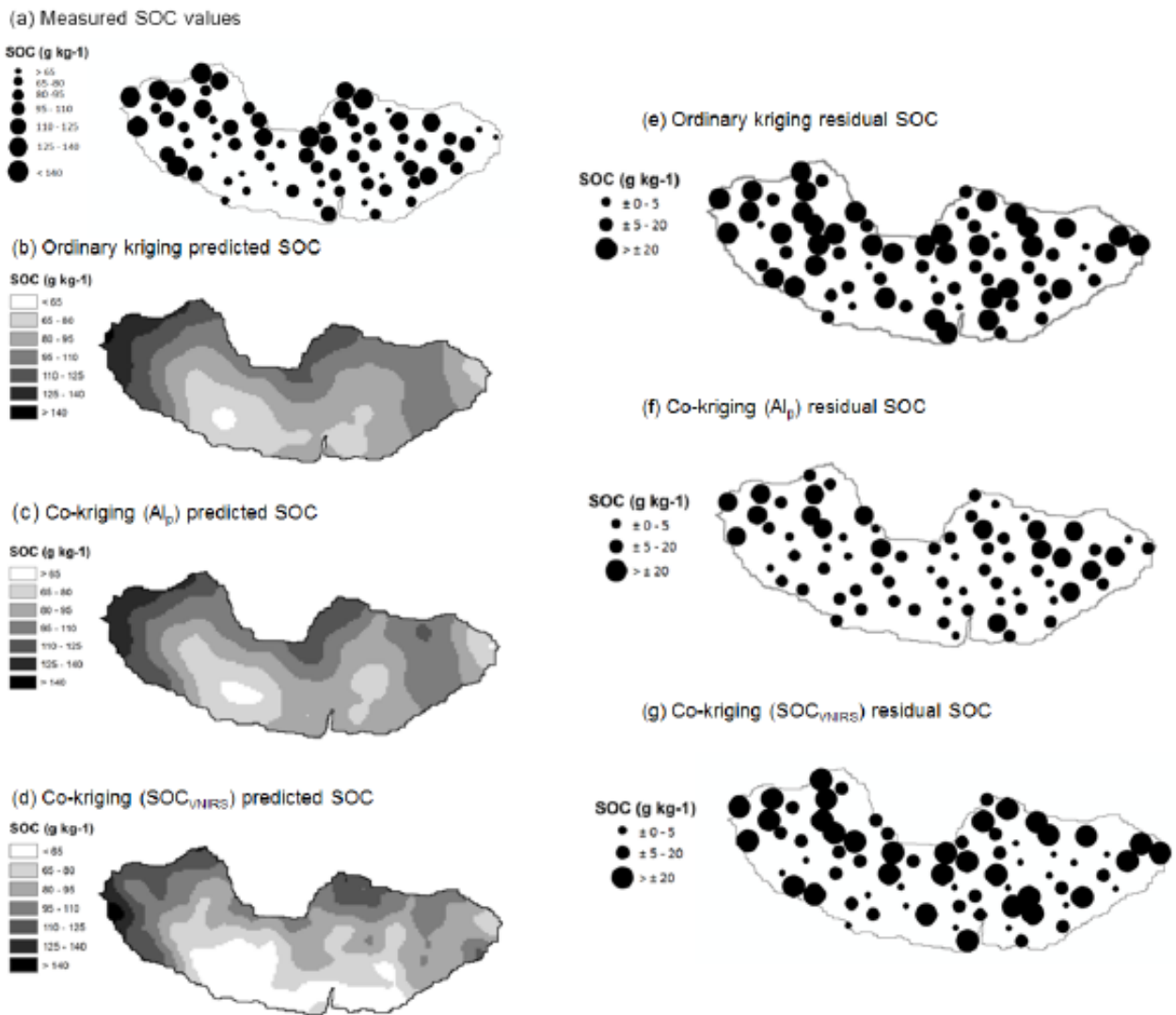

Fig. 18: Maps of a) measured soil organic carbon (SOC) by dry combustion; b) c) and d) predicted soil organic carbon; and e), f) and g) prediction residuals. Figures b) and e) are associated with the ordinary kriging method, c) and f) with co-kriging with aluminum extracted by sodium pyrophosphate (Al_p), and d) and g) with co-kriging with visible-near-infrared reflectance spectroscopy (VNIRS) predicted SOC (SOC_{VNIRS}). Kinoshita et al., Geoderma, 2015

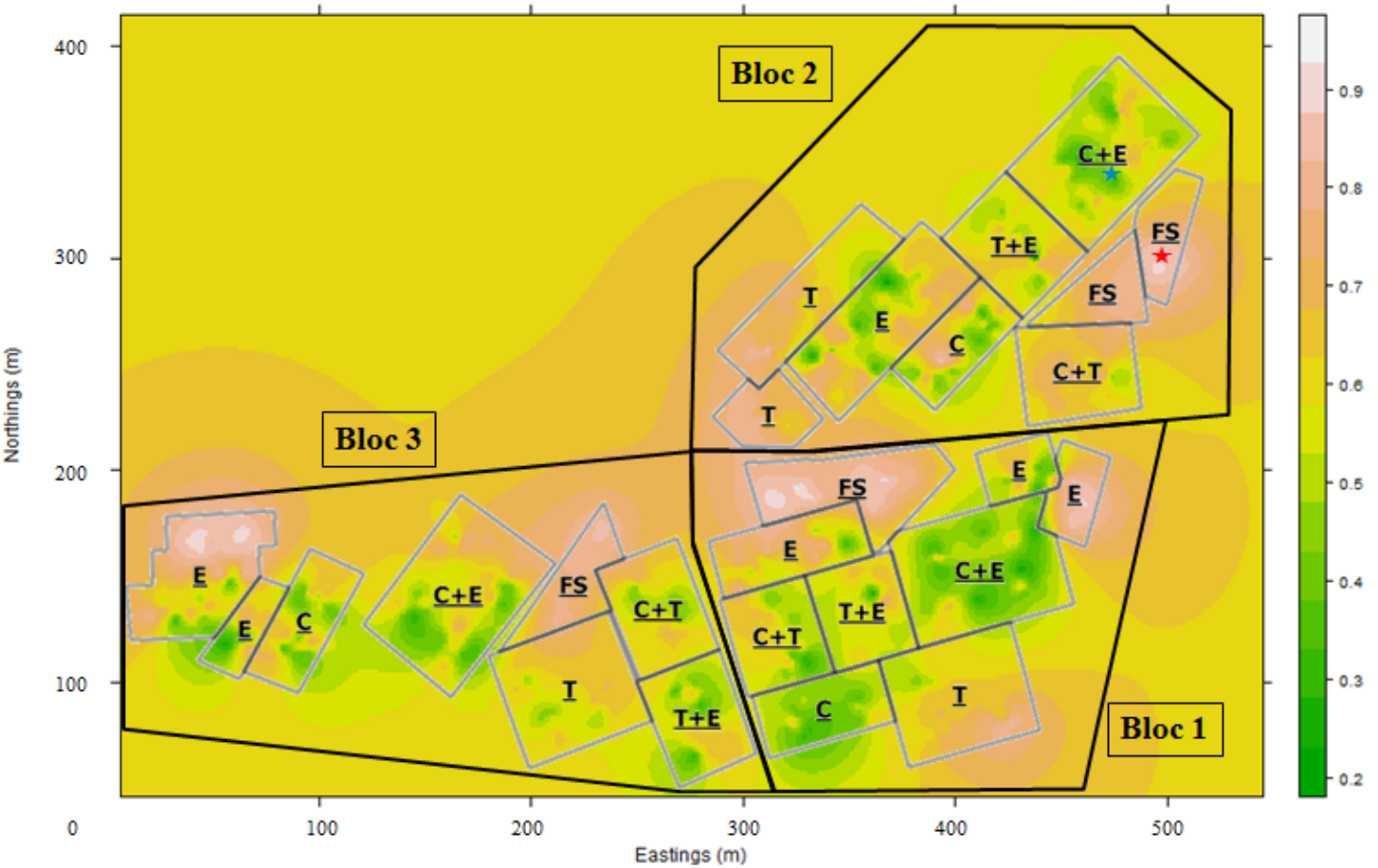

Figure 19 : Kriged map of shade tree canopy openness in the CATIE agroforestry trial. Grey lines represent the edges of the whole-plot treatment (Shade type) and black lines are for the 3 Blocs. C = *Chloroleucon*; T = *Terminalia*; E = *Erythrina*; ★ = Reference weather stations (blue: shaded in C+E, red: in Full-Sun, FS). N = 570 canopy openness measurements used for kriging. Source: MSc of Maxime Soma.

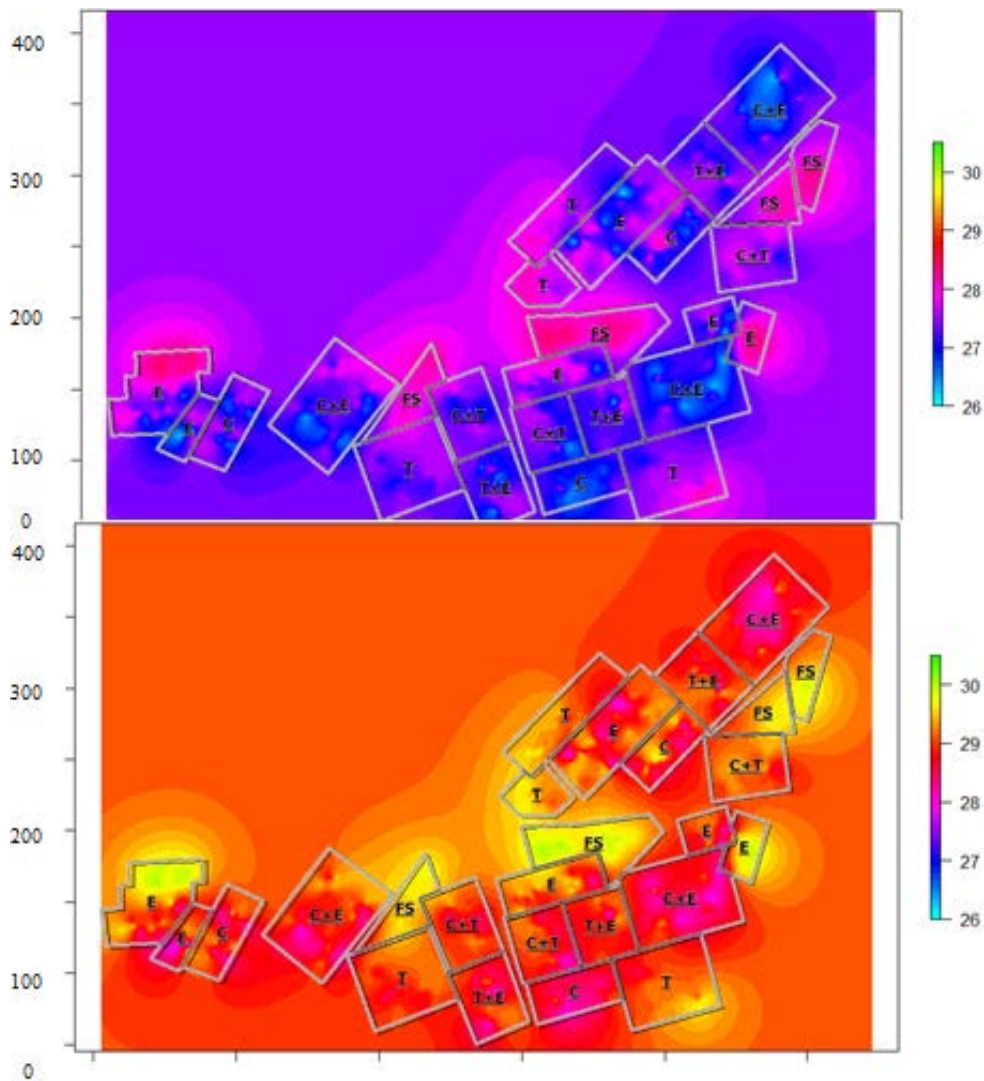

Figure 20 : Kriged map of predicted coffee canopy temperature (T_c) for typical days (top: 08/05/2015 at 02:08 PM; bottom: 01/06/2015 at 12:17 AM), exhibiting contrasted climatic conditions. Top map is typical of cloudy conditions and bottom map is typical of sunny days. Temperatures in $^{\circ}\text{C}$. $N=570$ kriged values. Vertical axis in meters. Colour scale in degree Celsius. Source: MSc of Maxime Soma.

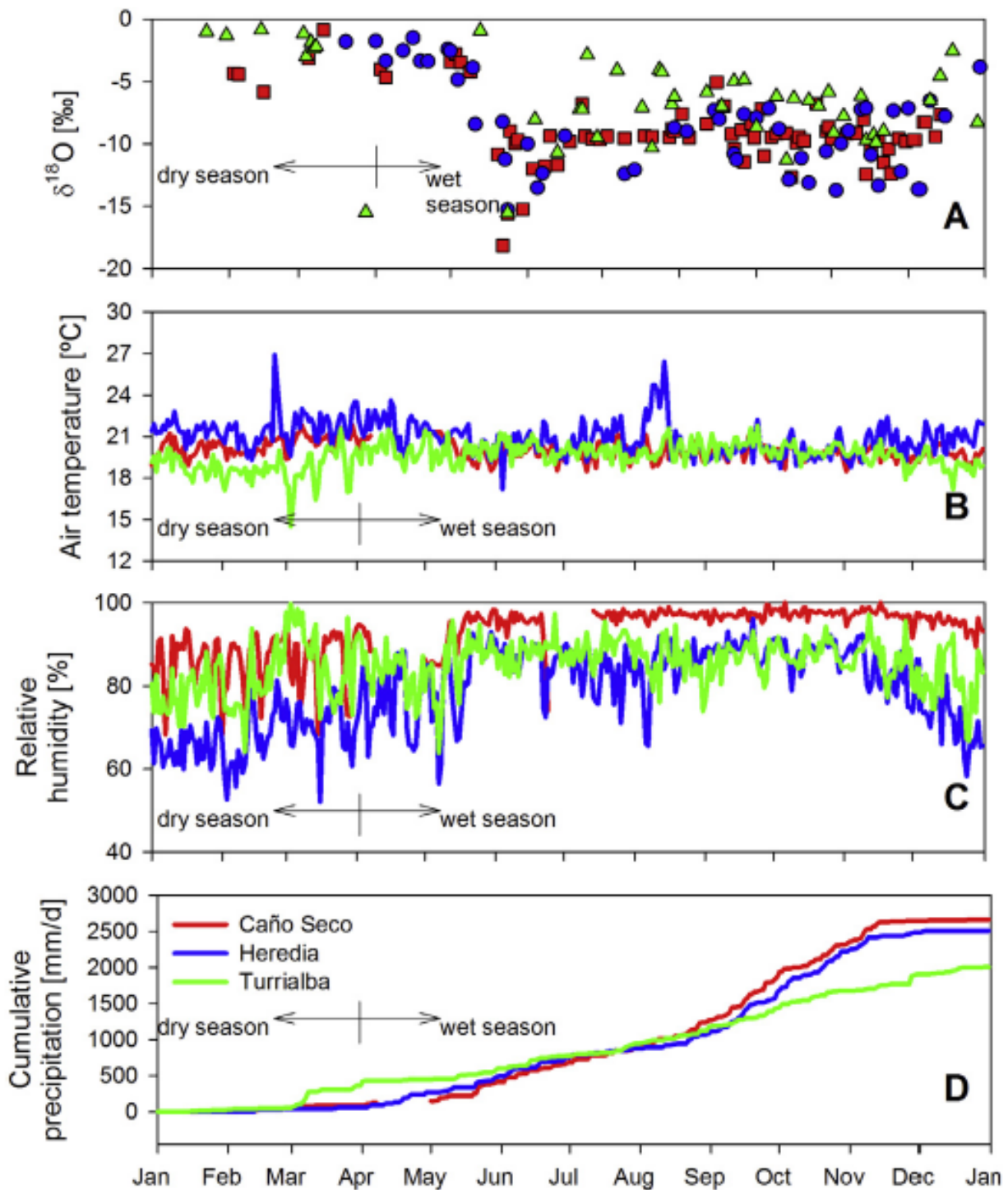

Figure 21 : Time series of (A) precipitation $\delta^{18}\text{O}$ and observed surface meteorological variables, (B) air temperature, (C) relative humidity and (D) cumulative precipitation during 2013 at the three study sites Heredia (blue), Turrialba (green) and Cano Seco (red). Black arrows denote the transition from the dry season (Dec-April) to the wet season (May-Nov). Source: Sanchez-Murillo et al., Quaternary Science Reviews, 2015

Local team and students

- Dr. Olivier Roupsard (UMR Eco&Sols/Cirad/CATIE, ecophysiological, bioclimatologist)
- Dr. Karel Van den Meersche (UMR Eco&Sols/Cirad/CATIE, ecophysiological)
- Dr. Clémentine Allinne (UMR System/Cirad/CATIE, phytopathologist)
- Dr. Bruno Rapidel (UMR System/Cirad/CATIE, agronomist, ecophysiological)
- Dr. Jacques Avelino (Cirad/CATIE, phytopathologist)
- Dr. Elias de Melo Virginio Filho (CATIE, agroforester)
- Dr. Federico Gómez-Delgado (WMO/ hydrologist)
- Dr. Muriel Navarro (Ti Motu Design/ biologist)
- Dr. Fabien Charbonnier (CONACyt-ECOSUR, ecophysiological)
- Dr. Simon Taugourdeau (CIRAD, ecologist)
- PhD std. Laura Benegas (CATIE/SLU, hydrologist)
- PhD std. Kristen Welsh Unwala (U. Idaho/CATIE/ hydrologist)
- PhD std. Junior Pastor Perez Molina (U. Viçosa-Supagro, ecophysiological)
- PhD std. Remi Vezy (U. Bordeaux, modeler-ecophysiological)
- MSc Rintaro Kinoshita (U. Cornell, pedologist)
- MSc Louise Audebert (U. Nancy I, ecophysiological)
- MSc Jérôme Nespoulous (U. Savoie, pedologist)
- MSc Elsa Defrenet (Agrocampus Ouest-Rennes, ecophysiological)
- MSc Emmanuelle Khac (Agroparistech_Montpellier, ecophysiological)
- MSc. Maxime Soma (AgroparisTech, ecophysiological)
- Ing. Titouan Baraer (VetAgro Sup, agronomist)
- Ing. std. Aurélie Cambou (ENSAIA-Nancy, ecophysiological)
- Ing. std. Anna Deffner (Supagro, ecophysiological)
- Ing. std. Laura Jarri (Supagro, ecophysiological)
- Ing. std. Florian Guidat (ENSAIA-Nancy, pedologist)
- Ing. std. Florian Rançon (Supagro, remote-sensing)
- Ing. std. Maëva Colombet (ENSAT, agronomist)
- A. Perez (CATIE, Technician)
- A. Barquero and family (Aquiaries farm, Technicians)

Collaborations

- . Aquiaries farm: MSc. Don Alfonso Robelo (CEO); MSc. Diego Robelo; MSc. Guillermo Ramirez; MSc. Rafael Vargas; MSc. Manuel Jara; MSc. Alonso Barquero
- . CATIE: Prof. Francisco Jiménez; Prof. Jeffrey Jones; Prof. Nelly Vasquez; Prof. Tamara Benjamin; Prof. Pablo Imbach; PhD std Luis Molina; MSc. Patricia Leandro
- . CIRAD : Dr. Anne Clément-Vidal
- . Idaho University (USA) : Dr. Lee Vierling; Dr. Jan Eitel; Prof. Jan Boll
- . Instituto Costarricense de Electricidad (ICE, Costa-Rica): Dr. Federico Gómez-Delgado
- . Swedish University of Agricultural Sciences (SLU): Prof. Anders Malmer; Dr. Ulrik Ilstedt
- . U. Copenhagen: Prof. Anders Priemé; Prof. Bo Elberling; Mathias Madsen
- . U. Toronto: Dr. Marney Isaac
- . U. Western Sydney-Australia: Dr. Remko Duursma
- . U. Macquarie NSW-Australia: Dr. Belinda Medlyn.
- . UMR BIOEMCO-Paris : Dr. Christian Valentin; Dr. Christian Hartmann
- . UMR ISPA ; Dr. Denis Loustau, Dr. J.-C. Domech
- . UMR-AMAP, Montpellier : Dr. Jean Dauzat; Dr. Alexia Stokes; Dr. Hervé Rey; Dr. Thierry Fourcaud; Dr. John Kim
- . UMR-CEFE, Montpellier : Dr. Catherine Roumet; Dr. Ivan Prieto-Aguilar
- . UMR-Eco&Sols Montpellier : Dr. Christophe Jourdan, Dr. Tiphaine Chevallier, Dr. Alain Albrecht ; Dr. Bernard Barthès, Dr. Philippe Thaler ; Dr. Yann Nouvellon ;
- . UMR-EEF, INRA Nancy : Dr. Erwin Dreyer (Président de Centre INRA);

- . UMR-LISAH, INRA Montpellier : Dr. Roger Moussa, Dr. Yves Le Bissonais, Dr. Marc Voltz
- . UMR-PIAF, INRA Clermont-Ferrand : Dr. André Lacoïnte
- . UNA-Stable Isotope Research Group: Universidad Nacional, Heredia Costa Rica. Ricardo Sánchez-Murillo; Kristen Welsh.
- . University of Copenhagen: Prof. Anders Priemé, Prof. Bo Elberling, Dr. Rasmus Kjoller.
- . University of Oslo: Prof. Lars Gottschalk; Dr. Irina Krasovskaia; Prof. Nils Roar
- . University of Viçosa, Brazil: Prof. Fabio Da Matta; PhD std. Junior Pastor Perez Molina
- . UMR ISPA: Jean-Marc Bonnefond, Dr. Denis Loustau, Dr. Delphine Picart, Prof. Jean-Christophe Domec
- . World Meteorological Organization (WMO, Costa-Rica): Dr. Federico Gómez-Delgado

Journal Articles (published)

- Benegas, L., Ilstedt, U., Roupsard, O., Jones, J.R., Malmer, A., 2014. Effects of trees on infiltrability and preferential flow in two contrasting agroecosystems in Central America. *Agric. Ecos. Envir.* , 185-196. <http://dx.doi.org/10.1016/j.agee.2013.10.027>
- Charbonnier, F., le Maire, G., Dreyer, E., Casanoves, F., Christina, M., Dauzat, J., Eitel, J.U.H., Vaast, P., Vierling, L.A., Roupsard, O., 2013. Competition for light in heterogeneous canopies: Application of MAESTRA to a coffee (*Coffea arabica* L.) agroforestry system. *Agricultural and Forest Meteorology* 181, 152-169. <http://dx.doi.org/10.1016/j.agrformet.2013.07.010>
- Gómez-Delgado, F., Roupsard, O., le Maire, G., Taugourdeau, S., Perez, A., van Oijen, M., Vaast, P., Rapidel, B., Harmand, J.M., Voltz, M., Bonnefond, J.M., Imbach, P., Moussa, R., 2010. Modelling the hydrological behaviour of a coffee agroforestry basin in Costa Rica. *Hydrol. Earth Syst. Sci.* 15, 369-392. www.hydrol-earth-syst-sci.net/15/369/2011/doi:10.5194/hess-15-369-2011
- Kinoshita R, Roupsard O, Chevallier T, Albrecht A, Taugourdeau S, Ahmed Z, van Es HM. 2016. Large topsoil organic carbon variability is controlled by Andisol properties and effectively assessed by VNIR spectroscopy in a coffee agroforestry system of Costa Rica. *Geoderma*, 262: 254-265. <http://dx.doi.org/10.1016/j.geoderma.2015.08.026>
- Prieto I, Roumet C, Cardinael R, Dupraz C, Jourdan C, Kim JH, Maeght JL, Mao Z, Pierret A, Portillo N, Roupsard O, Thammahacksa C, Stokes A. 2015. Root functional parameters along a land-use gradient: evidence of a community-level economics spectrum. *Journal of Ecology*, 103: 361-373. [DOI: 10.1111/1365-2745.12351](http://dx.doi.org/10.1111/1365-2745.12351)
- Sánchez-Murillo R, Birkel C, Welsh K, Esquivel-Hernández G, Corrales-Salazar J, Boll J, Brooks E, Roupsard O, Sáenz-Rosales O, Katchan I, Arce-Mesén R, Soulsby C, Araguás-Araguás LJ. 2016. Key drivers controlling stable isotope variations in daily precipitation of Costa Rica: Caribbean Sea versus Eastern Pacific Ocean moisture sources. *Quaternary Science Reviews*, 131, Part B: 250-261. <http://dx.doi.org/10.1016/j.quascirev.2015.08.028>
- Taugourdeau, S., le Maire, G., Avelino, J., Jones, J.R., Ramirez, L.G., Jara Quesada, M., Charbonnier, F., Gómez-Delgado, F., Harmand, J.-M., Rapidel, B., Vaast, P., Roupsard, O., 2014. Leaf area index as an indicator of ecosystem services and management practices: An application for coffee agroforestry. *Agriculture, Ecosystems & Environment* 192, 19-37. <http://dx.doi.org/10.1016/j.agee.2014.10.033>

Journal Articles (submitted)

- Defrenet E, Roupsard O, Van den Meersche K, Charbonnier F, Perez Molina JP, Khac E, Prieto I, Stokes A, Roumet C, Rapidel B, De Melo Virginio Filho E, J. VV, Robelo D, Barquero Aguillar A, Jourdan C. 2015. Deep root biomass and net primary productivity in a coffee agroforestry system of Costa Rica. *Annals of Botany*. Submitted November 2015.
- Gómez-Delgado F, Roupsard O, Vaast P, Robelo A, Moussa R. 2014. When runoff and sediments are not coming from plots: a spatio-temporal analysis in a coffee agroforestry system. *Agriculture Ecosystems & Environment*. Submitted December 2015.

Thesis

- Audebert L. 2011. Productivité aérienne du café agroforestier : effets de l'ombrage et de l'âge des rejets. Master II. UHP Nancy I, Nancy, France, p 25 pp + Annexes
- Benegas, L., 2010-2013. The role of trees for groundwater recharge: PhD research plan, CATIE/SLU October 2009 – November 2013. Faculty of forest Sciences. Swedish University of Agricultural Sciences (SLU), Umeå/Uppsala/Alnarp.
- Cambou, A., 2012. Mesures des sucres lents et rapides d'organes de caféier par double approche VISNIR et Biochimique. Césure ENSAIA, Rennes.
- Charbonnier, F., 2013. Measuring and modelling light, water and carbon budgets and net primary productivity in a coffee-based agroforestry system of Costa Rica. PhD. Ecole doctorale RP2E. Université de Nancy I. 19 dec 2013, p. 54 p. + Appendices.

- Deffner, A., 2012. Partition du bilan hydrique d'une parcelle de café agroforestier au Costa Rica. Césure. Supagro-ENSAM, Montpellier, p. 31.
- Defrenet, E. 2012. Evaluating belowground biomass and net primary productivity (NPP) of coffee in an coffee agroforestry system in of Costa Rica., Master II Productions Végétales option Ingénierie des Agrosystèmes. Agrocampus Ouest Rennes-France. 29 pp + Appendices.
- Deswarte, C. 2015. Spatio-temporal distribution of coffee diseases according to shade in agroforestry systems, Master II Productions Végétales option Ingénierie des Agrosystèmes. Agrocampus Ouest Rennes-France. XX pp + Appendices.
- Jarri, L., 2012. Adaptation to Climate Change and Genotype x Environment Interactions in leaf water-use efficiency and carbon isotope discrimination ($\Delta^{13}C$) of Coffee F1 hybrids: a field trial experiment under contrasting altitudinal and drought conditions. Césure. Supagro-ENSAM, Montpellier.
- Khac, E., 2012. Plasticity and Genotype x Environment Interactions in productivity, biomass partitioning and drought tolerance of Coffee F1 hybrids in Costa Rica. MSc. Aproparistech, Montpellier.
- Kinoshita, R., 2009. Experimental display for rainfall interception and steady state infiltrability in a coffee agroforestry system of Costa Rica (E.U. CAFNET/Coffee-Flux project in AQUIARES farm). Internship report, April to August 2009. Cirad, CATIE, PCP, Turrialba, p. 31.
- Kinoshita, R., 2012. Strategies for soil quality assessment using VNIR hyperspectral spectroscopy. Cornell, USA., New-York. Master Sc. 89pp.
- Gómez-Delgado, F., 2010. PhD Thesis: Hydrological, ecophysiological and sediment processes in a coffee agroforestry basin: combining experimental and modelling methods to assess hydrological environmental services. Centre international d'études supérieures en sciences agronomiques -Montpellier Supagro; Ecole doctorale Systèmes Intégrés en Biologie, Agronomie, Géosciences, Hydrosiences, Environnement (SIBAGHE), Montpellier, p. 254.
- Nespoulos J. 2011. Relations entre la stabilité structurale, la résistance au cisaillement et les caractéristiques physicochimiques des sols-Application sur trois sites agroforestiers. Master Sciences et technologies: U. Savoie, Montpellier, p 25 + annexes.
- Perez Molina, J.P., 2013. Variabilidad temporal y espacial de la respiración del suelo y su partición en respiración autotrófica y heterotrófica, necromasa y tasas de liberación de nutrientes de la hojarasca, en un sistema agroforestal de café, comparado a bosque de origen. MSc, Dep. Forestal, CATIE. Costa Rica. 29 Nov 2013, p. 82.
- Perez Molina JP. 2014-2018. Coffee Acclimation to elevated [CO₂]. A field experiment with FACE (Free-Air CO₂ Enrichment) in Brazil, PhD project PhD, PhD Project, U. Viçosa, Brazil. Bourses du Sud CIRAD.
- Soma M. 2015. On the relationship between structure and canopy temperature in stands: comparing Shaded and Full-Sun situations in a coffee agroforestry trial in Costa Rica, Nancy I. MSc, Master Forêt, agronomie, gestion des écosystèmes, Spécialité Forests and their environment, AgroParisTech Nancy I. Defended 1st of September 2015. 25pp + Appendices.
- Taugourdeau S. 2010. Indice foliaire d'un système agroforestier à base café, mesure, dynamique et relation avec la production. Master FENEC: Université des Sciences et Technologies du Languedoc, Montpellier, p 12 + annexes.
- Vezy R. 2014-2017. Simulation of alternative management practices for perennial plantation adaptation to global changes, PhD, Université de Montpellier 2, France.
- Welsh, K., 2011-2014. Balance of water and contaminants in various systems of the Reventazon watershed (Costa Rica). PhD project. U. Idaho-CATIE, IGERT, Idaho.

Communications

- Charbonnier, F., Rouspard, O., Dreyer, E., Le Maire, G., 2012. Using the MAESTRA model to simulate light interactions and photosynthesis in a heterogeneous agroforestry system under alternative density and pruning practices. Oral Presentation. 30th AMS Conference on Agricultural and Forest Meteorology. American Meteorological Society, Boston, MA, USA, 29 May -- 1 June 2012.
- Charbonnier, F., Le Maire, G., Dreyer, E., Casanoves, F., Christina, M., Dauzat, J., Eitel, J., Vierling, L., Van den Meersche, K., Harmand, J.M., Rouspard, O., 2014. The End of the Sun / Shade dichotomy in AFS: mapping of plant light budgets in multistrata heterogeneous plots. Oral Presentation. World Congress on Agroforestry, Dehli, India, 10-14 February 2014.
- Charbonnier, F., Rouspard, O., Casanoves, F., Audebert, L., Defresnet, E., Cambou, A., Alline, C., Rapidel, B., Avelino, J., Van den Meersche, K., Harmand, J.M., Jourdan, C., Vaast, P., Barquero Aguillar, A., Leandro, P., Dreyer, E., 2014. Strong spatial variability of light use efficiency in a coffee AFS, highlighted by 3D light and gas exchange model. Oral Presentation. World Congress on Agroforestry, Dehli, India, 10-14 February 2014.
- Dauzat, J., Griffon, S., Rouspard, O., Vaast, P., Rodrigues, G., 2013. Building the foundations of a Coffea arabica FSPM. In: Risto Sievänen, E.N., Christophe Godin, Anna Lintunen, Pekka Nygren (Ed.),

- Proceedings of the 7th International Conference on Functional-Structural Plant Models (FSPM2013), Saariselkä, Finland, 9-14 June 2013. Vantaa, : Finnish Society of Forest Science, p. 269-270. International Conference on Functional-Structural Plant Models. 7, 2013-06-09/2013-06-14, Saariselkä, Finland, Saariselkä, Finland.
- Le Maire, G., Nouvellon, Y., Roupsard, O., Christina, M., Charbonnier, F., Zhou, J., Ponzoni, F.J., Stape, J.L., Dautat, J., Couteron, P., Proissy, C., 2012. Very high resolution images for parameterization of tree-scale forest process-based models. Poster. IEEE. Proceedings of 2012 IEEE International Geoscience and Remote Sensing Symposium (IGARSS 2012), Munich, Germany, 22-27 July 2012,. Piscataway : IEEE, p. 6553-6556. IEEE International Geoscience and Remote Sensing Symposium, 2012-07-22/2012-07-27, Munich, Germany.
- Le Maire, G., Raçon, F., Charbonnier, F., Roupsard, O., 2014. Characterizing the structure of coffee agroforestry systems in Costa Rica. Poster. Pleiades days. April 1-3 2014, Toulouse, France.
- Roupsard, O., Gómez Delgado, F., Rapidel, B., le Maire, G., 2009. Why is agroforestry so challenging for modellers? How to conciliate complexity, interactions, accuracy and upscaling? A proposed strategy for agroforestry modelling. In: Rapidel, B., Roupsard, O., Navarro, M.N. (Eds.), Modelling Agroforestry Systems. Workshop Proceedings. CATIE, Turrialba, Costa Rica, 25-29 February 2008. Technical Series. Technical meetings n°14. ISBN 978-9977-57-479-4, pp. 69-80.
- Roupsard, O., Gómez-Delgado, F., Moussa, R., Rapidel, B., Perez, A., Barquero, A., Rivera Wilson, C., Benegas, L., Kinoshita, R., Taugourdeau, S., Navarro, M.N.V., Jourdan, C., Le Maire, G., Harmand, J.-M., Bonnefond, J.M., Vaast, P., 2010. The CAFNET/Coffee-Flux project: evaluating water, sediment and carbon ecosystem services in an agroforestry coffee watershed (Costa Rica). 21st Century Watershed Technology: Improving Water Quality and Environment. American Society of Agronomical and Biological Engineers (ASABE), University La Earth Costa Rica, Poster presentation.
- Roupsard, O., Charbonnier, F., Taugourdeau, S., Kinoshita, R., Guidat, F., Raçon, F., Le Maire, G., Van den Meersche, K., Jourdan, C., Harmand, J.M., Vaast, P., De Melo, E., Imbach, A., Albrecht, A., Chevallier, F., Do, F., Rocheteau, A., Chotte, J.L., 2014. Using process models, remote sensing and spectrometry to open scientific locks in agroforestry systems: the example of coffee in Costa Rica. Poster. In: FAO (Ed.), International Symposium on Agroecology for Food and Nutrition Security, FAO, Rome, 18-19 sept. 2014. FAO, Rome.
- Roupsard O. 2014. Cafetaleras cerca de la Carbono-Neutralidad. Un método original y sencillo para mostrarlo Documento Powerpoint, 30 diapositivas. Charla a La Junta Nacional del Carbono. 12 de Diciembre 2014. Powerpoint. Centro de Cambio Climático, San Pedro, San José, Costa Rica.
- Roupsard O. 2014. ¿Es mi finca cafetalera Carbono-Neutral? Acompañando productores de café con su certificación Carbono Neutral. Documento Powerpoint, 30 diapositivas. Visita de Campo en la finca Aquiares y charla a la GIZ, ICAFE, NAMA-Café, Fundecooperación, MAG, MINAE. 15 de Mayo 2014. Aquiares, Turrialba Costa Rica.
- Roupsard O, Loustau D, Subervie J, Le Maire G, Laclau JP, Nouvellon Y, Domec JC, De Melo E, Imbach P, Rapidel B, Le Coq JF, Augusto L, Avelino J, Van den Meersche K, Duursma RA, Medlyn B, Trichet P, Bosc A, Maris C, Garcia A, E. B, Le Meilleur S, Picart D, Lamour A, Vezy R. 2014. MACACC ANR Project: Modelling to accompany stakeholders towards adaptation of forestry and agroforestry systems to global changes (MACACC). ANR Agrobiosphère 2014-2017 (ANR-13-AGRO-0005). 3 million euros budget. Xylofutur-MACACC: <http://xylofutur.fr/macacc/>.
- Roupsard O. 2015. Accompanying NAMA-Café with the C-Neutral certification : a joint PCP effort to link our activities with socio-economical stakes. In: PCP, ed. PCP Evaluation. CATIE.
- Roupsard O. 2015. La utilización de modelos para apoyar la validación de Innovaciones Agroforestales. In: CATIE, ed. Diseño de Piloto de Sistemas Agroforestales en el ámbito de la NAMA-CAFÉ Costa Rica–CATIE-CIRAD-FUNDECOOPERACIÓN-ICAFE-MAG. CATIE: NAMA-Café Costa Rica.
- Roupsard O, Soma M. 2015. Visio-chat : Agroforesterie et changement climatique, l'exemple du Costa-Rica. Participants : lycée Franco-Costaricien de San José (Costa Rica) / lycée agricole de Mirecourt, Vosges / collège de Langogne, Lozère / Vigie de l'eau, Vittel. <http://www.lavigiedeleeau.eu/node/822> . 30th of April 2015. Visio-Chats. Vittel.
- Roupsard O, Van den Meersche K, Rapidel B, De Melo Virginio Filho E, Charbonnier F, Alline C, Avelino J, Roumet C, Stokes A, Bonnefond J-M, Vierling L, Boll J, Dreyer E, Saint-André L, Loustau D, Elberling B, Isaac ME, Malmer A, Sanchez-Murillo R, Vargas V, Fonseca C. 2015. COFFEE-FLUX (Costa Rica): Observatory for monitoring and modeling carbon, nutrients, water and sediment ecosystem services in coffee agroforestry systems; Mitigation and adaptation to climate changes through ecosystem manipulation. ANAEE-France. Toulouse.
- Sánchez-Murillo R, Welsh K, Birkel C, Esquivel Hernández G, Corrales-Salazar J, Boll J, E. B, Roupsard O, Sáenz-Rosales O, I. K, Arce-Mesén R, C. S, Araguás-Araguás L. 2015. Key drivers controlling daily stable isotope variations in precipitation of Costa Rica: Caribbean Sea versus eastern Pacific Ocean

- moisture sources. Paper EGU2015-4277. Oral presentation and Poster, session AS4.8/BG1.11/CL5.11/HS7.10. 2015 IAEA Isotope Hydrology Symposium. Vienna, Austria, 15th April 2015.
- Somarriba E, Roupsard O. 2015. Impactos del cambio climatico sobre el café. Entrevista de la radio Columbia 98.7FM. 11 de Setiembre de 2015. 30 minutos.
- Soto, M., 2011. Como se sabe cuanto carbono captura un cafetal? , El Periodico La NACION-Costa Rica, 5th of June 2011, San José.
- Soto, M. 2012. Cafetales con arboles funcionan como esponjas durante las lluvias, pp. 20 El Periodico La NACION-Costa Rica, 27th of June 2012, San José.
- Taugourdeau, S., Le Maire, G., Roupsard , O., Avelino, J., Gómez-Delgado, F., Jones, J.R., Marsden, C., Robelo, A., Alpizar, E., Barquero, A., Rapidel , B., Vaast, P., Harmand, J.M., 2010. LAI dynamics of agroforestry and full sun coffee systems in Costa Rica. Poster. ASIC 2010, Bali, Indonesia, October 3-7 2010. Poster Communication and Proceedings.
- Vezy R, Picart D, Christina M, Soma M, Charbonnier F, Loustau D, Le Maire G, Roupsard O. 2016. Effect of shade on temperature mitigation and canopy assimilation of coffee agroforestry systems. EURAF: 3rd European Agroforestry Conference, 23-25 May 2016, Montpellier, France. Poster presentation.
- Vezy R, Picart D, Roupsard O, Charbonnier F, Loustau D, Le Maire G. 2016. Coupling a 3D light interception with a growth and yield model to adjust the shade level in coffee agroforestry systems simulated under climate change. 32nd Conference on Agricultural and Forest Meteorology, 20-24 June 2016, Salt Lake City, Utah, USA. Oral presentation.
- Welsh K, Boll J, Roupsard O. 2014. Seasonal isotope hydrology of a coffee agroforestry watershed in Costa Rica. Poster. AGU. December 2014. Session "Emerging Issues in Tropical Ecohydrology". San Francisco, USA.

Workshops organized

- Roupsard, O., L. Vierling, J. Eitel, G. Le Maire, and J. Dauzat. 2011. PCP Workshop. "From the Leaf to the Landscape: Field and Remote Sensing Approaches for Understanding Vegetation Structure and Dynamics". CATIE, 12-13 May 2011. Website: <https://sites.google.com/site/laiworkshoppcp/> [Online].
- Roupsard, O., Loustau, D., Braconnier, P., 2014. Modelling to accompany stakeholders towards adaptation of forestry and agroforestry systems to global changes (MACACC). Kickoff meeting Bordeaux-Lacanau, France. 17-24 of March 2014. <https://sites.google.com/site/macacclacanau/>.
- Roupsard O, Loustau D, Subervie J, Le Maire G, De Melo E, Imbach P, Rapidel B, Le Coq JF, Van den Meersche K, Garcia A, Lamour A. 2014. Modelling to accompany stakeholders towards adaptation of forestry and agroforestry systems to global changes (MACACC). Costa Rica meeting Tarrazu & CATIE, October 2014. <https://sites.google.com/site/macaccostarica/>.

Visitors

Coffee-Flux is also place for organizing visits, training and for demonstrating the PCP, CATIE, Aquiares and Cirad collaboration: we organize one or two visits per month for officials (e.g. coffee sector in Central America, MAG, Fundecooperacion, GIZ, NAMA-Café), politicals (MAE, French Embassy), journalists (Daily Newspaper-La Nación; Et si on changeait le monde-Television, Vigie de l'eau-Visio conference and Web site), University Professors (Norway, Sweden, Denmark, USA, England), groups of students (all levels, e.g. U. Costa Rica), and congress field trips (21st Century Watershed Technology Conference ASABE; ASIC 2012-Costa Rica)

Contacts and links

<p>Olivier Roupsard Tree-Crop Physiologist CIRAD-Persyst, UMR Ecologie Fonctionnelle and Biogéochimie des Sols and Agroécosystèmes, SupAgro-CIRAD-INRA-IRD, Montpellier, France.</p>	<p>Posted at: CATIE 7170, Apartado 3 Cartago, Turrialba 30501 COSTA RICA Email : olivier.roupsard@cirad.fr</p>
--	--

Web sites:

<p>CIRAD-Persyst: Agricultural Research for development: http://www.cirad.fr/en UMR ECO&SOLS: http://www.montpellier.inra.fr/ecosols Theme 3 of UMR Eco&Sols: Carbone et changements globaux: http://www5.montpellier.inra.fr/ecosols/Themes-de-recherche/carbone_changements_globaux CATIE (Centro Agronómico Tropical de Investigación y Enseñanza): http://www.catie.ac.cr/</p>
--

Coffee-Flux platform: <http://www6.montpellier.inra.fr/ecosols/Recherche/Les-projets/CoffeeFlux>