



**HAL**  
open science

## ICARE-VEG: A 3D physics-based atmospheric correction method for tree shadows in urban areas

K.R.M. Adeline, X. Briottet, X. Ceamanos, T. Dartigalongue, Jean-Philippe Gastellu-Etchegorry

► **To cite this version:**

K.R.M. Adeline, X. Briottet, X. Ceamanos, T. Dartigalongue, Jean-Philippe Gastellu-Etchegorry. ICARE-VEG: A 3D physics-based atmospheric correction method for tree shadows in urban areas. ISPRS Journal of Photogrammetry and Remote Sensing, 2018, 142, pp.311-327. 10.1016/j.isprsjprs.2018.05.015 . hal-01835698

**HAL Id: hal-01835698**

**<https://hal.science/hal-01835698>**

Submitted on 11 Jul 2018

**HAL** is a multi-disciplinary open access archive for the deposit and dissemination of scientific research documents, whether they are published or not. The documents may come from teaching and research institutions in France or abroad, or from public or private research centers.

L'archive ouverte pluridisciplinaire **HAL**, est destinée au dépôt et à la diffusion de documents scientifiques de niveau recherche, publiés ou non, émanant des établissements d'enseignement et de recherche français ou étrangers, des laboratoires publics ou privés.

1 **ICARE-VEG: A 3D PHYSICS-BASED ATMOSPHERIC CORRECTION METHOD**  
2 **FOR TREE SHADOWS IN URBAN AREAS**

3  
4  
5 4 K.R.M. Adeline<sup>ab</sup>, X. Briottet<sup>a</sup>, X. Ceamanos<sup>a1</sup>, T. Dartigalongue<sup>a</sup>, J.-P. Gastellu-Etchegorry<sup>c</sup>  
6  
7 5

8  
9 6 <sup>a</sup>The French Aerospace Lab (ONERA), 31055 Toulouse, France

10 7 <sup>b</sup>University of Toulouse, Higher Institute of Aeronautics and Space (ISAE), 31055 Toulouse,  
11 France  
12  
13 8

14 9 <sup>c</sup>Centre for the Study of the Biosphere from Space (CESBIO), 31401 Toulouse, France

15  
16 10 E-mail address of corresponding author: karine.adeline@onera.fr  
17  
18 11

19  
20 12 **KEYWORDS**

21  
22 13  
23 14 atmospheric correction,  
24  
25 15 radiative transfer,  
26  
27 16 hyperspectral,  
28  
29 17 high spatial resolution,  
30  
31 18 tree shadows,  
32  
33 19 urban areas  
34  
35 20

36 21 **ABSTRACT**  
37  
38 22  
39

40 23 Many applications dedicated to urban areas (e.g. land cover mapping and biophysical  
41 properties estimation) using high spatial resolution remote sensing images require the use of  
42 24 3D atmospheric correction methods, able to model complex light interactions within urban  
43 25 topography such as buildings and trees. Currently, one major drawback of these methods is  
44 26 their lack in modelling the radiative signature of trees (e.g. the light transmitted through the  
45 27 tree crown), which leads to an over-estimation of ground reflectance at tree shadows. No  
46 28 study has been carried out to take into account both optical and structural properties of trees in  
47 29 the correction provided by these methods. The aim of this work is to improve an existing 3D  
48 30 atmospheric correction method, ICARE (Inversion Code for urban Areas Reflectance  
49 31 Extraction), to account for trees in its new version, ICARE-VEG (ICARE with VEGetation).  
50  
51  
52  
53  
54  
55  
56  
57  
58  
59

---

60 <sup>1</sup> Present address : CNRM, Météo-France/CNRS, 31057 Toulouse, France  
61  
62  
63  
64  
65

33 After the execution of ICARE, the methodology of ICARE-VEG consists in tree crown  
34 delineation and tree shadow detection, and then the application of a physics-based correction  
35 factor in order to perform a tree-specific local correction for each pixel in tree shadow. A  
36 sensitivity analysis with a design of experiments performed with a 3D canopy radiative  
37 transfer code, DART (Discrete Anisotropic Radiative Transfer), results in fixing the two most  
38 critical variables contributing to the impact of an isolated tree crown on the radiative energy  
39 budget at tree shadow: the solar zenith angle and the tree leaf area index (LAI). Thus, the  
40 approach to determine the correction factor relies on an empirical statistical regression and the  
41 addition of a geometric scaling factor to account for the tree crown occultation from ground.  
42 ICARE-VEG and ICARE performance were compared and validated in the Visible-Near  
43 Infrared Region (V-NIR: 0.4-1.0 $\mu\text{m}$ ) with hyperspectral airborne data at 0.8m resolution on  
44 three ground materials types, grass, asphalt and water. Results show that (i) ICARE-VEG  
45 improves the mean absolute error in retrieved reflectances compared to ICARE in tree  
46 shadows by a multiplicative factor ranging between 4.2 and 18.8, and (ii) reduces the spectral  
47 bias in reflectance from visible to NIR (due to light transmission through the tree crown) by a  
48 multiplicative factor between 1.0 and 1.4 in terms of spectral angle mapper performance.  
49 ICARE-VEG opens the way to a complete interpretation of remote sensing images (sunlit,  
50 shade cast by both buildings and trees) and the derivation of scientific value-added products  
51 over all the entire image without the preliminary step of shadow masking.

## 52 53 **1. Introduction**

54  
55 The potential of hyperspectral remote sensing imagery with high spatial resolution in  
56 the reflective domain 0.4-2.5 $\mu\text{m}$  has long been studied to increase the characterization of  
57 surface materials for ecosystem monitoring (Wulder et al., 2004), and particularly for urban  
58 environments (Jensen and Cowen, 1999; Small, 2001; Puissant and Weber, 2014), such as for  
59 vegetation biodiversity assessment (Alonzo et al., 2014), road traffic monitoring (Rosenbaum  
60 et al., 2010) and land cover classification (Roessner et al., 2001). For urban applications, one  
61 major limitation comes from the complex topography of urban landscapes combined with low  
62 solar elevation, which induces many shaded pixels in aerial and satellite images at high spatial  
63 resolution. In image processing, shaded region areas are often neglected, with shadows  
64 classified as a material class (Dell'Acqua et al., 2005; Yuan and Bauer, 2006) or used to  
65 retrieve the dimensions of nearby buildings (Liow and Pavlidis, 1990).

66 The processing of shadows involves both shadow detection (Adeline et al., 2013a) and  
67 shadow correction (Shahtahmassebi et al., 2013). For shadow correction purposes, two main  
68 categories of methods can be examined. The first includes de-shadowing methods using  
69 multisource data fusion or applying a radiometric enhancement correction to "re-light" shaded  
70 pixels generally based on histogram adaptation strategies (Dare, 2005). Although sufficient  
71 for coarse classification of urban material types, it is unsatisfactory for the intra-class  
72 variability quantification and the retrieval of physico-chemical properties of surface materials,  
73 which requires the accurate spectral reflectance of each material. The second category of de-  
74 shadowing methods uses atmospheric correction codes to convert at-sensor radiance into  
75 reflectance units. They are physics-based methods which correct the radiometrical bias  
76 occurring in shaded pixels by considering atmospheric conditions and sometimes the scene  
77 3D topography (e.g. Digital Surface Model - DSM or a vector model). To our knowledge,  
78 only a few atmospheric correction codes are adapted to urban environments: the semi-  
79 empirical model of Chen et al., 2013, ICARE (Inversion Code for urban Areas Reflectance  
80 Extraction, Lachéradé et al., 2008) and ATCOR-4 (Atmospheric/topographic correction for  
81 airborne imagery, Richter and Schläpfer, 2002). However, only the two last codes can achieve  
82 an exact calculation of the 3D radiative terms to retrieve surface reflectance.

83 ATCOR-4 is currently the most used atmospheric correction code by the scientific  
84 community that has been tested for a large panel of hyperspectral airborne sensors over the  
85 spectral range 0.4-2.5 $\mu$ m. For a flat terrain composed of lambertian materials (i.e.  
86 corresponding to an isotropic light reflection), ATCOR-4 performance achieves an error in  
87 the retrieved reflectance of 0.02 and 0.04 for an initial reflectance of less than 0.10 and 0.40,  
88 respectively (Rese ATCOR-4 User Guide; Richter and Schläpfer, 2002). For a rugged terrain,  
89 ATCOR-4 performance is not quantified since it strongly depends on the DSM accuracy and  
90 the registration between the image and the DSM (Rese ATCOR-4 User Guide; Schläpfer et  
91 al., 2000). An improved version of ATCOR named BREFCOR is able to correct the effects of  
92 bidirectional reflectance distribution function of materials (Schläpfer et al., 2015). ICARE is a  
93 3D atmospheric correction method dedicated to urban areas with lambertian materials. It was  
94 initially developed to process airborne multispectral images acquired by the PELICAN image  
95 system (Duffaut and Deliot, 2005) with spectral bandwidth of 30nm at a spatial resolution of  
96 20cm, and with limited spatial extent. Its performance showed a maximum peak to peak  
97 accuracy of 0.04 in the retrieved reflectance for eight spectral bands from 420 to 917nm and  
98 for pixels located in shadows cast by buildings (Lachéradé et al., 2008). Currently, ICARE is  
99 being improved to process hyperspectral images. The improved method named ICARE-HS

100 (ICARE using HyperSpectral imagery) was tested with airborne HySpex hyperspectral data  
101 with 160 spectral bands in the Visible-Near Infrared (V-NIR: 0.4-1.0 $\mu$ m) at a spatial  
102 resolution of 80cm (Ceamanos et al., 2017). The performance of this new ICARE version was  
103 not quantitatively validated.

104 Atmospheric correction codes succeed in modeling opaque objects governed by  
105 absorption and reflection processes (e.g. buildings). However, the main issue lies in the lack  
106 of modeling of transmittance processes resulting from semi-transparent and transparent  
107 surfaces (e.g. trees and windows). For trees, ATCOR-4 and ICARE neglect the fraction of the  
108 incident solar radiation that is transmitted through tree crown, thus generating a bias in the  
109 retrieved reflectance in tree shadows (Adeline et al., 2012; Schläpfer et al., 2013; Damm et al,  
110 2015). Actually, the under-estimation of total irradiance in the shade produces an over-  
111 estimation of retrieved reflectance, which is higher in the NIR bands than in the visible with a  
112 transition close to the red-edge (Adeline et al., 2012; Damm et al, 2015). With ICARE,  
113 Adeline et al., 2012 showed that the retrieved reflectance in tree shadows compared to their  
114 counterpart in sunlit areas for the same material type (asphalt and grass) gave mean root mean  
115 square error values up to 0.09. With ATCOR-4, Damm et al, 2015 showed that an inaccurate  
116 estimation of irradiance can lead to a difference in tree shadows in NDVI values (Normalized  
117 Difference Vegetation Index; Rouse, 1974) up to 13% and in PRI values (Photochemical  
118 Reflectance Index; Gamon et al., 1992) up to 32% for some test scenarios over grass. One of  
119 the required steps to solve this issue is to carry out a sensitivity analysis in order to know  
120 which tree canopy parameters, both spectral (e.g. optical properties of leaves and wood) and  
121 structural (e.g. leaf area index, leaf angular distribution, clumping, tree dimensions) have the  
122 most impact on light transmission through the tree crown. To our best knowledge, such an  
123 analysis has not been performed yet for radiative transfer budget estimation.

124 The objective of this work is to improve the existing 3D atmospheric correction code  
125 ICARE to cope with the presence of trees. The new version is further named ICARE-VEG  
126 (ICARE with VEGetation). It is based on the building of a physics-based correction factor to  
127 apply to ICARE's outputs in order to provide a better estimation of surface reflectance in tree  
128 shadows. The challenge is to define a general correction baseline adapted to any urban trees  
129 and requiring a small number of relevant variables to study. To this end, ICARE-VEG relies  
130 on the decoupling between a spectral reference correction based on a "reference tree model"  
131 with fixed geometrical dimensions, and a spatial correction accounting for the real dimensions  
132 of the tree processed in the image. The spectral reference correction is built from the results of  
133 a sensitivity analysis based on a design of experiments to derive the most important factors

134 contributing to light transmission through the tree crown. The spatial correction factor is  
135 computed from the tree dimensions and the location of the pixel within the tree shadow. At  
136 last, ICARE-VEG only considers deciduous trees with green healthy leaves and surfaces with  
137 a lambertian spectral behaviour.

138 This paper is organized as follows. Section 2 introduces the physical principles of  
139 radiative transfer modeling for ICARE-VEG. Section 3 describes each step implemented in  
140 ICARE-VEG. Section 4 presents the airborne and field data used for validation. Finally, the  
141 performance of ICARE-VEG for surface reflectance retrieval in tree shadows is presented in  
142 section 5. Conclusion and perspectives are given in section 6.

## 144 2. Physical modeling for ICARE-VEG

146 For a given wavelength  $\lambda$  in the optical domain 0.4-2.5 $\mu\text{m}$ , the surface reflectance  $\rho$  of  
147 a target is derived from the direct upwelling radiance  $R$  coming from the target and  
148 reaching a given pixel of the sensor detector matrix, the total downwelling irradiance  
149 received at ground, and the upwelling direct atmospheric transmission (Fig. 1; Lachérade  
150 et al., 2008) such as:

$$152 \quad \text{---} \quad \text{---} \quad (1)$$

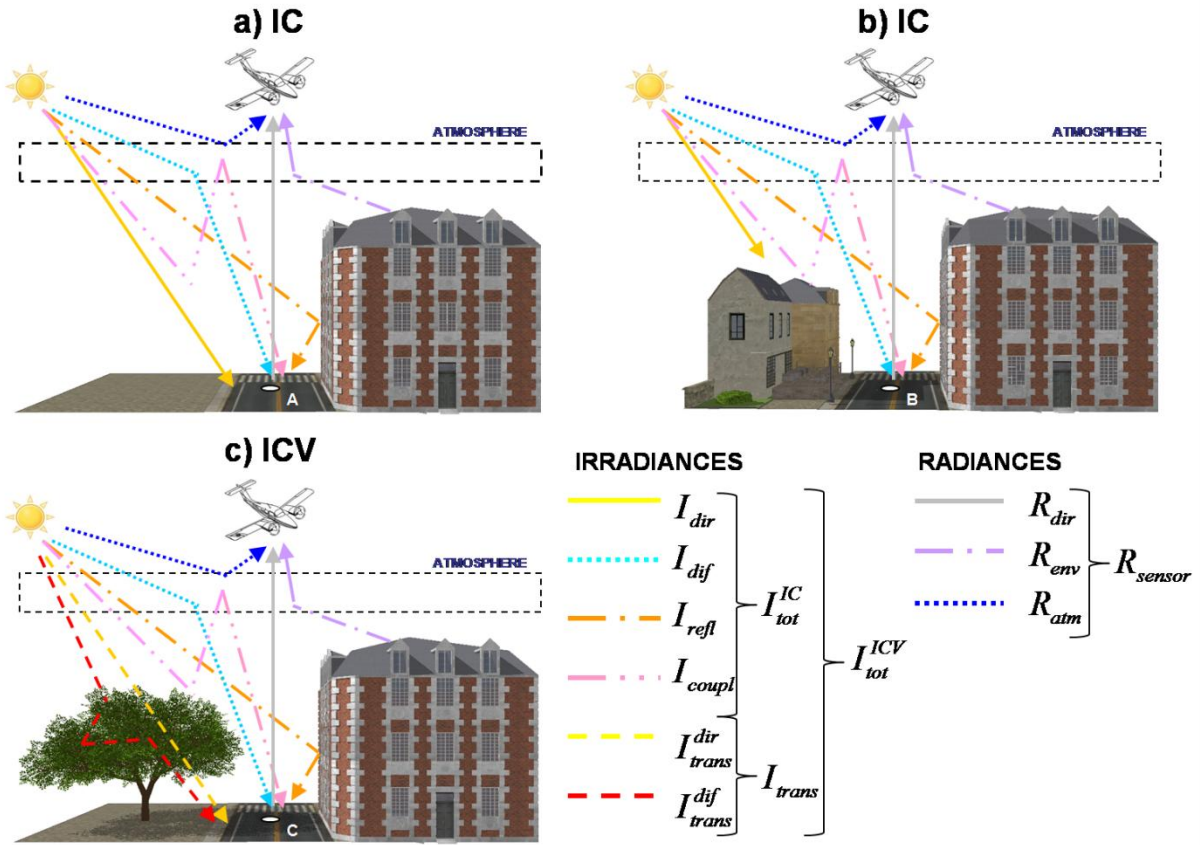


Fig. 1. Taxonomy of the radiative transfer components for ICARE (IC) and ICARE-VEG (ICV) for an urban scene and for a target a) in the sun, b) in a building shadow and c) in a tree shadow.

In urban environment, the radiative components  $R_{dir}$  and  $I_{tot}$  are highly sensitive to the complex 3D topography inducing downwelling and upwelling multiple reflections on surrounding surface elements, and to local atmospheric multiple scattering. The total at-sensor radiance,  $R_{sensor}$ , is the sum of the direct radiance,  $R_{dir}$ , the environment radiance due to the atmospheric light scattering,  $R_{env}$ , and the atmospheric radiance (the so-called path radiance),  $R_{atm}$  (Fig. 1). Also, the total irradiance,  $I_{tot}^{IC}$ , is the sum of the direct solar irradiance,  $I_{dir}$ , the atmospheric diffuse solar irradiance,  $I_{dif}$ , the irradiance due to scattering by the surrounding environment,  $I_{refl}$ , and the earth-atmosphere coupling irradiance,  $I_{coupl}$  (Fig. 1).

ICARE (noted  $IC$ ) considers that surfaces have lambertian reflectances and the viewing direction is Nadir. The surface spectral bidirectional reflectance for any pixel  $P$  at the wavelength  $\lambda$  is simply named  $\rho(P, \lambda)$ . ICARE analytically determines the surface reflectance for a pixel  $A$  in a sunlit region (Fig. 1a) with:

172

1

2 173

3

4 174

5

6 175

7

8 176

9

10 177

11

12 178

13

14 179

15

16 180

17

18 181

19

20 182

21

22 183

23

24 184

25

26 185

27

28 186

29

30 187

31

32 188

33

34 189

35

36

37 190

38

39 191

40

41 192

42

43 193

44

45 194

46

47 195

48

49 196

50

51 197

52

53 198

54

55 199

56

57 200

58

59 201

60

61

62

63

64

65

$$\text{---} \quad \text{---} \quad \text{---} \quad \text{---} \quad (2)$$

For a pixel  $B$  in any shaded region (Fig. 1b), ICARE assumes  $\rho_{\text{veg}}$  to be null, leading to the following expression:

$$\text{---} \quad \text{---} \quad \text{---} \quad \text{---} \quad (3)$$

This reflectance determination for  $\rho_{\text{veg}}$  is only valid for shadows cast by opaque surface materials such as buildings. In shaded regions cast by trees, however, the incoming light transmitted through tree crowns,  $\rho_{\text{veg}}$ , must be considered in addition to  $\rho_{\text{veg}}$  (Fig. 1c). The term  $\rho_{\text{veg}}$  can be split into  $\rho_{\text{veg}}$ , the light directly transmitted without interactions with the tree elements, and  $\rho_{\text{veg}}$ , the light that is transmitted after at least one scattering with crown elements, either leaves or woody stems (Fig. 1c). Consequently, Eq. 3 needs to be modified for a pixel  $C$  in tree shadow with a more accurate estimation of total irradiance received at ground,  $E_{\text{g}}$ , such as :

$$\text{---} \quad \text{---} \quad \text{---} \quad \text{---} \quad (4)$$

with

The goal of ICARE-VEG (noted  $ICV$ ) is to update ICARE retrieved surface reflectance to cope with tree shadows. It requires to solve Eq. 4 from Eq. 3 with the introduction of a physics-based correction factor  $\beta$  which is the ratio between the transmitted light,  $E_{\text{g}}$ , and the total irradiance computed by ICARE,  $E_{\text{g}}$ , with the following expression:

$$\text{---} \quad \text{---} \quad \text{---} \quad \text{---} \quad (5)$$

The factor  $\beta$  depends on the wavelength  $\lambda$ , and the solid angle  $\Omega$  under which the tree crown that casts the shadow is seen from any pixel  $C$  in the shadow. The analytical determination of  $\beta$  is not straightforward due to both the spectral and spatial dependence of



the ratio  $\beta$ . Here, the main assumption is that the spectral and spatial response of  $\beta$  can be linearly decorrelated. Thus,  $\beta$  is decomposed as follows:

$$\beta = \beta_{ref} \cdot \beta_{C} \quad \text{with} \quad \beta_{ref} = \frac{\beta_{ref}}{\beta_{C}} \quad (6)$$

$\beta_{ref}$  is the mean spectral response of  $\beta$  according to a "reference tree model" with fixed geometric dimensions.  $\beta_{C}$  is further called the reference correction factor. It is associated with a reference solid angle  $\Omega_{ref}$ .  $\Omega$  is the solid angle at the location of the pixel  $C$  for the real geometrical dimensions of the tree in the scene.

### 3. ICARE-VEG method implementation

The semi-automatic ICARE-VEG correction code is structured as depicted in Fig. 2. The original ICARE code is executed as a preliminary step (section 3.1). Individual trees and their associated shadows are then identified to perform a tree-specific local correction for each pixel in tree shadow (sections 3.2 and 3.3). The physics-based correction factor  $\beta$  (section 3.4) is divided into the determination of the reference correction factor  $\beta_{ref}$  (section 3.4.1) and the solid angles,  $\Omega_{ref}$  and  $\Omega$  (section 3.4.2).  $\beta_{ref}$  is evaluated in 3 steps. They rely on a "reference tree model" with fixed geometrical dimensions to study how  $\beta$  is impacted by tree crown biophysical and structural variables, and other external variables. For that purpose, the DART 3D radiative transfer code is used to simulate light interactions within a tree crown (Discrete Anisotropic Radiative Transfer; Gastellu-Etchegorry et al, 1996). The results are stored in a look-up table and a sensitivity analysis aims at defining the major variables required to assess  $\beta_{ref}$  (section 3.4.1.1). Then, these major variables are derived from the processed image (section 3.4.1.2) and they are used to empirically compute  $\beta_{ref}$  thanks to statistical multivariate strategies (section 3.4.1.3). At last, ICARE-VEG correction provides an improved reflectance retrieval for the pixels in tree shadows, while pixels in the sun and in the shadow of buildings are not updated from ICARE outputs (section 3.5).

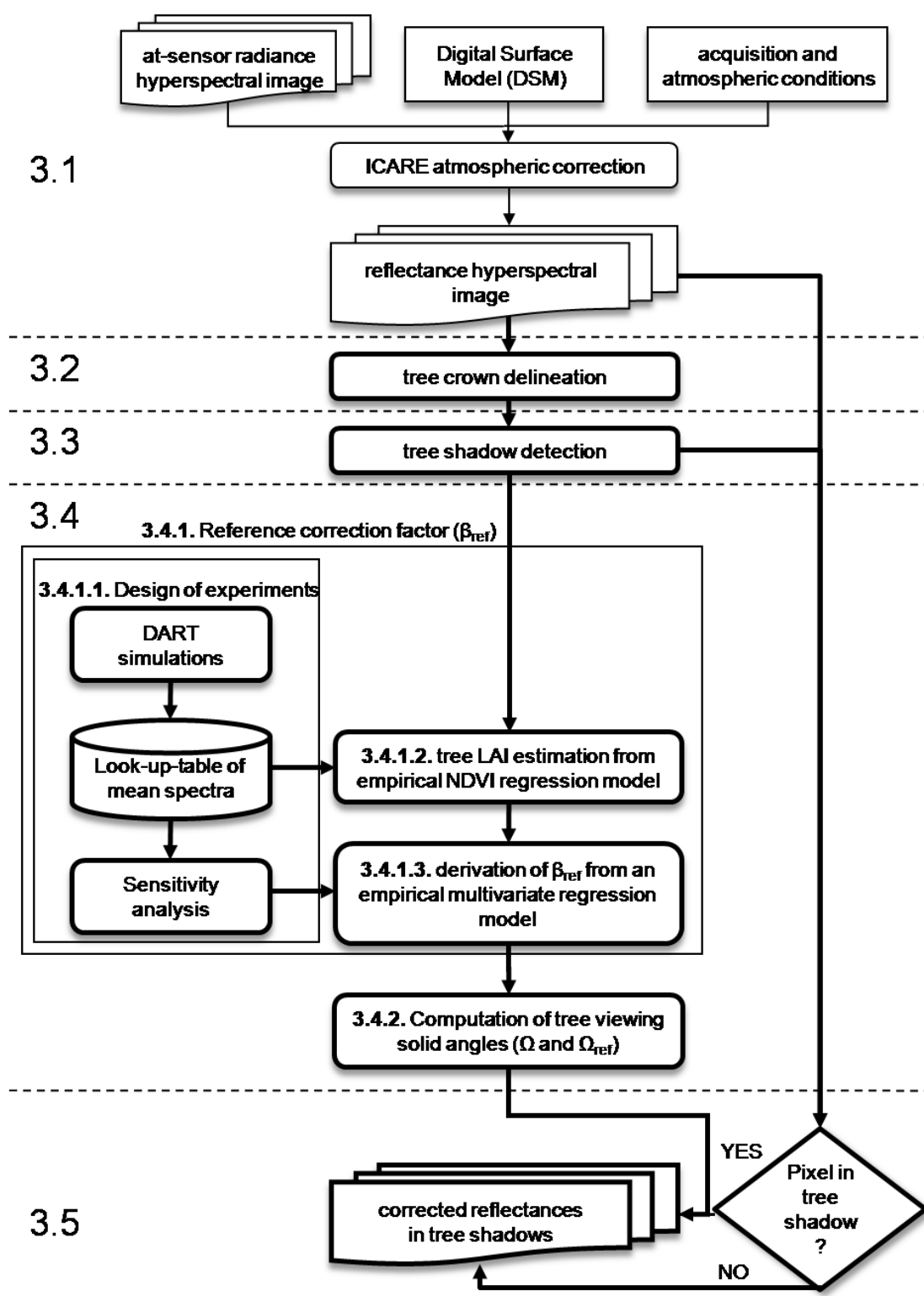


Fig. 2. ICARE-VEG method workflow (3.1 existing ICARE method, from 3.2 to 3.5 new developments presented in this paper, highlighted by bold boxes).

3.1. Atmospheric correction by ICARE

ICARE (Lachérade et al., 2008) requires 3 inputs: an at-sensor image expressed in spectral radiance unit, a DSM and the geometry conditions (e.g. flight altitude, sensor spatial and spectral characteristics, sun and viewing angles) and the atmospheric conditions. Atmospheric radiative components are computed with the radiative transfer code 6SV (Vermote et al., 1997). The output is an image of spectral surface reflectance.

### 3.2. Tree crown delineation

Two consecutive image segmentations are performed for delineating the individual tree crowns: detection of tree clusters, and separation of individual tree crowns in each cluster (Fig. 3).

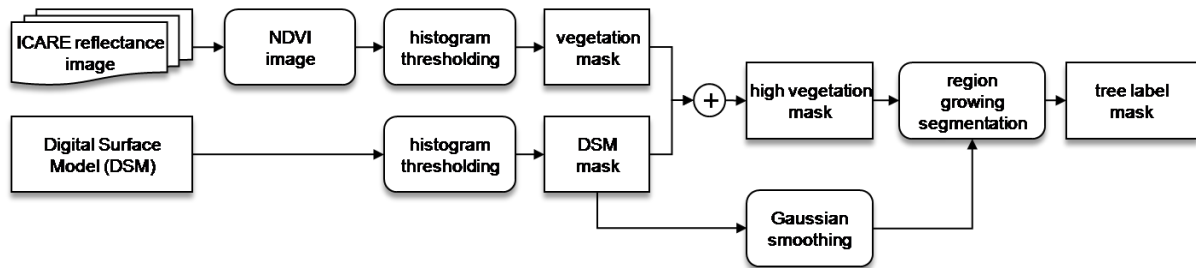


Fig. 3. Flowchart of the individual tree crown delineation.

First, pixels of vegetation are extracted in the image by computing the NDVI with the red band at 670nm and the NIR band at 800nm. The histogram of the NDVI image is thresholded with the bimodal technique of Otsu (1979) to create a binary vegetation mask. Then, a refinement step uses the DSM to separate high vegetation (e.g. trees) and low vegetation (e.g. grass). The histogram of the DSM image is classified with a user-defined threshold based on the minimum tree height the user wants to consider. The overlap between the resulting DSM mask and the vegetation mask generates the high tree vegetation mask (i.e. tree clusters location).

Afterwards, individual tree crowns are delineated within each tree cluster. Zheng et al., 2016 give a relevant review of long studied techniques in the literature. The most used technique is raster-based using extrapolation, interpolation and smoothing procedures for treetop detection and crown segmentation. First, the DSM mask is smoothed with a Gaussian filter in order to flatten the strong irregularities on top of tree canopies. Second, a region growing segmentation based on the method of Iovan et al. (2014) is used to delineate the tree

crowns. In short, the method detects local maxima in the DSM from the high vegetation mask, attributes a tree label to each treetop, and then performs a gradient descent technique to give a tree label to all pixels in the high vegetation mask. This step provides a tree label mask.

To avoid the detection of several treetops for the same tree, an adjacency condition sets the minimum distance between two treetops. This distance, expressed in a number of pixels, essentially depends on the image spatial resolution. The tree label mask is refined with two other criteria. The first removes trees with very small crowns, using a minimum number of pixels per tree label. The second one eliminates tree crowns that are partially in the shade of other trees or buildings. For that, it uses a maximum percentage of shaded pixels for a tree crown.

### 3.3. Tree shadow detection

The identification of tree shadows is twofold: detection of all the shadows in the image and assignation of tree labels for tree shadows pixels (Fig. 4).

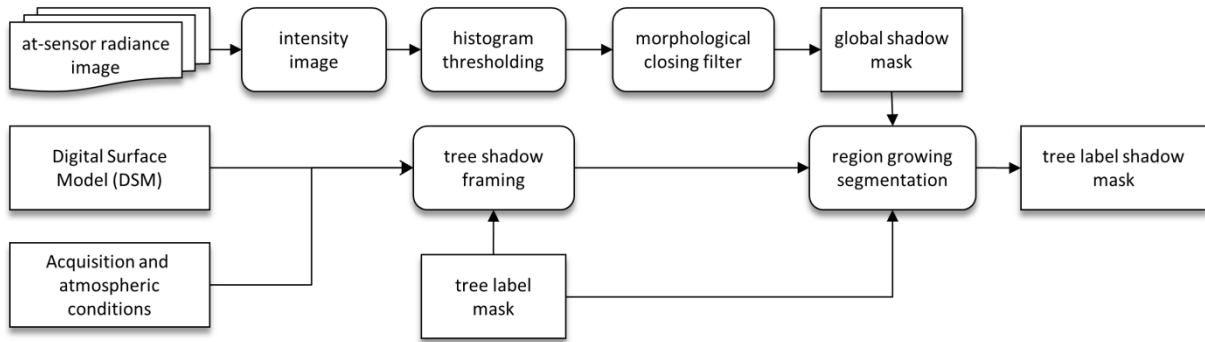


Fig. 4. Flowchart of the individual tree shadow detection.

First, the shadow mask is created using an intensity image (noted  $I$ ) computed from the combination of four radiance ( $R$ ) spectral images ( $B$ : 470nm,  $G$ : 550nm,  $R$ : 670nm and  $NIR$ : 800nm):

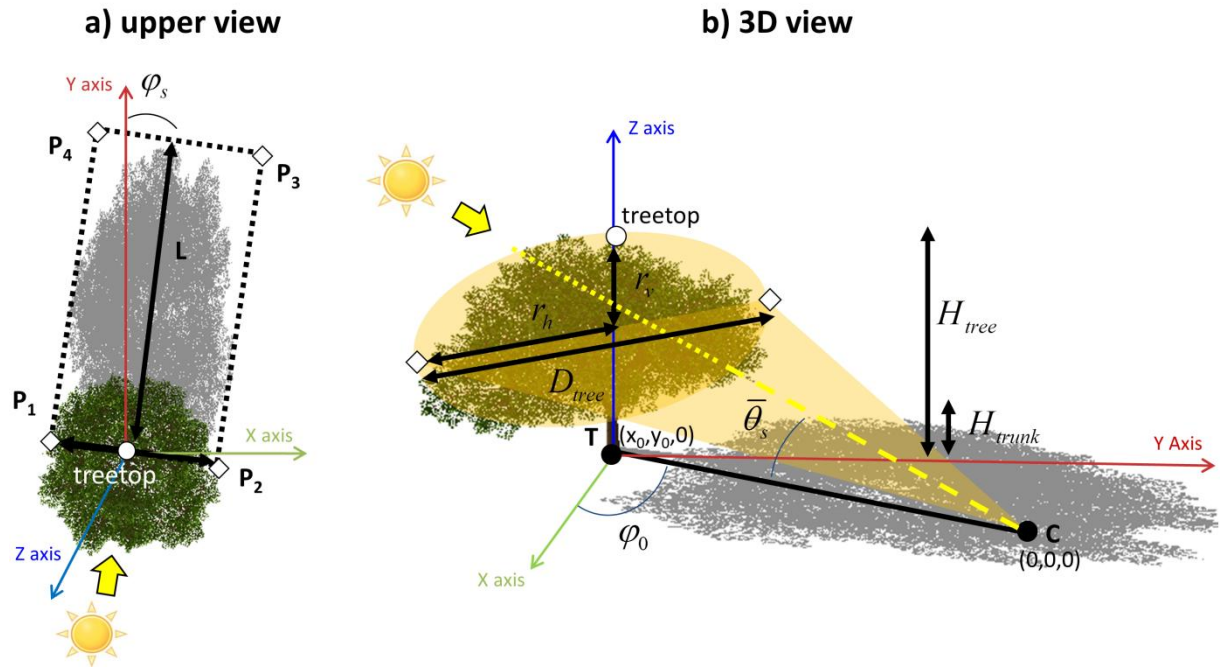
$$I = \frac{2 \times (R_{NIR} + R_R) + R_B + R_V}{6} \quad (7)$$

A global shadow binary mask is derived from this intensity image by histogram thresholding following the first valley detection method of Nagao et al.(1979). This method has shown good performance for high spatial resolution aerial images (Adeline et al, 2013a).

294 A morphological closing filter is applied in order to spatially homogenize the tree shadows  
 295 possibly containing many penumbra areas.

296 Second, the detection of tree shaded pixels is achieved by framing each individual tree  
 297 shadow with a rectangular box with vertices  $P_1 - P_2 - P_3 - P_4$  (Fig. 5a). The edge  $P_1 - P_2$  of  
 298 this box represents the tree crown diameter, which is the segment intersecting the treetop in  
 299 the direction perpendicular to the sun azimuth angle  $\varphi_s$ . The orientation of the adjacent edges  
 300 of the box, namely  $P_2 - P_3$  and  $P_1 - P_4$ , is driven by  $\varphi_s$  while their length is dependent on the  
 301 tree shadow length  $L$  (Fig. 5a) following sun ray parallel projection to the ground (Roskopf  
 302 et al., 2017). This length  $L$  is actually computed from the knowledge of the ground sampling  
 303 distance (GSD), the sun zenith angle ( $\theta_s$ ), and the tree height ( $H_{tree}$ ) derived from the treetop  
 304 position and the DSM:

$$L = \frac{\tan(\theta_s) \times H_{tree}}{GSD} \quad (8)$$



308  
 309 Fig. 5. Geometric configurations with an isolated tree for a) tree shadow framing and b) solid  
 310 angle computation from a point  $C$  in tree shadow and for a tree crown modelled as an  
 311 ellipsoid (for the annotations see Appendix B).

312  
 313 Once the dimensions of the rectangular box are known, a region growing technique is  
 314 applied, consisting in gradually scanning the box area and looking for pixels that belong to the  
 315 global shadow mask but do not fall into the labeled pixels of the tree label mask. Each

316 detected tree shaded pixel is assigned to the corresponding tree label to build a tree shadow  
1 317 label mask.

3 318 In case of overlapping tree shadows, the highest tree is assumed predominant over the  
4  
5 319 others. Also, a shaded region cannot be associated with more than one tree. And a refinement  
6  
7 320 step is applied to remove small tree shadows based on a criterion counting the number of  
8  
9 321 pixels belonging to each tree label.

10 322

### 12 323 *3.4. Correction factor determination*

14 324

16 325 The correction factor  $\beta$  is the product between the reference correction factor  
17  
18 326  $\beta_{ref}$  (section 3.4.1) and a ratio of viewing solid angles  $\Omega(C)/\Omega_{ref}$  (section 3.4.2; Eq. 6).

20 327

#### 22 328 *3.4.1. Reference correction factor*

23 329

25 330 A regression model is built using a design of experiments based on a "reference tree  
26  
27 331 model" for further empirical computation of  $\beta_{ref}$ .

29 332

##### 31 333 *3.4.1.1. Design of experiments with DART and sensitivity analysis*

32 334

34 335 A simple scenario was considered in the form of an isolated tree on a flat ground, for  
35  
36 336 urban mid-latitude conditions and considering a viewing direction at Nadir (Fig. 6). Table 1  
37  
38 337 gives the DART input parameters that describe the scene and the "reference tree model"  
39  
40 338 (Gastellu-Etchegorry et al, 1996). The latter has fixed arbitrary dimensions, an ellipsoid  
41  
42 339 crown, and a trunk outside and inside the crown with a cylindrical and conical shape,  
43  
44 340 respectively. The DART spatial discretization scheme was set to 0.4m (i.e. spatial resolution  
45  
46 341 of the output image).

47 342

49

50

51

52

53

54

55

56

57

58

59

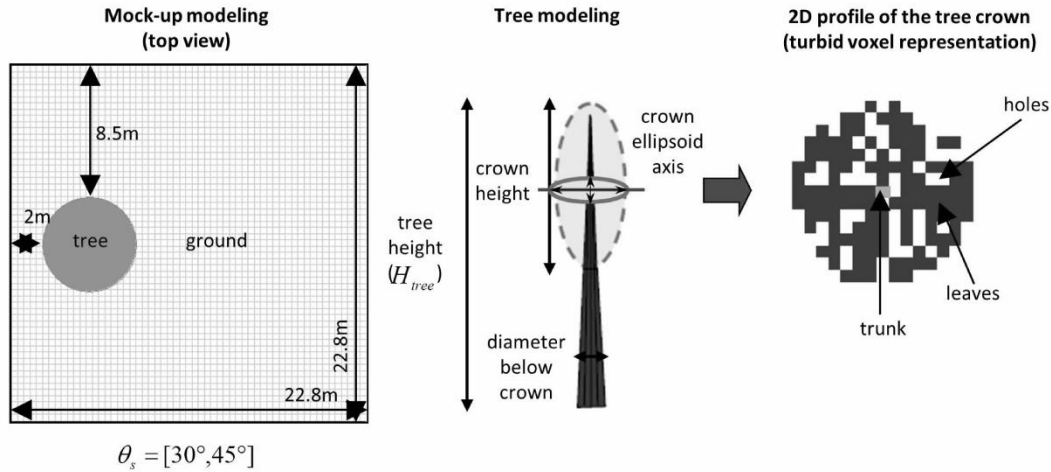


Fig.6. "Reference tree model" building from the DART interface.

Table 1. DART settings for the design of experiments (the abbreviations of the variables of interest are given in brackets and in bold)

	Variables [units]	Values
Sun geometry	Zenith angle [°] ( <b>SUN</b> )	30 - 45 - 60
	Azimuth angle [°]	90 (relative value)
Sensor geometry	Zenith angle [°]/ azimuth angle [°]	0 / 0
Spectral bands	Number <sup>a</sup> / Range [μm]	110/ 0.4 - 1.0
	FHWM <sup>b</sup> [nm]	3.7
Atmospheric conditions	Gaseous atmospheric profile	Mid-latitude summer
	Aerosol type	Urban
	Visibility [km] ( <b>VISI</b> )	10 - 23
Scene	Dimensions in x,y,z [m x m x m]	For a zenith angle <60°: 22.8 x 22.8 x 14.0 For a zenith angle = 60°: 30.8 x 30.8 x 14.0
	Voxel size in x,y,z [m x m x m]	0.4 x 0.4 x 0.4
	Ground reflectance ( <b>GROUND</b> )	Asphalt and grass (cf. Fig.7)
	Tree height [m]/ tree crown height [m]	14.2 / 9.4
Isolated tree	Tree crown ellipsoid axis in x,y [m x m]	6 x 6
	Trunk diameter below crown [m]	0.4

---

Tree leaf area index [ $\text{m}^2 \cdot \text{m}^{-2}$ ] ( <b>LAI</b> )	0.5 - 1 - 1.5 - 2 - 2.5 - 3 - 3.5 - 4 - 6 - 8
Leaf angle distribution	ellipsoidal
Average leaf angle [ $^\circ$ ]( <b>ALA</b> )	30 - 57.58 - 70
Horizontal random distribution of holes in the tree crown [%] <b>(POROSITY)</b>	0 - 30 - 70
Leaf optical properties ( <b>LOP</b> )	Liquidambar, oak and poplar (cf. Fig.7)

---

<sup>a</sup>*Spectral bands inside atmospheric water vapour windows are not considered*

<sup>b</sup>*FHWM: Full-Half-Width-Maximum*

In agreement with previous studies characterizing the canopy reflectance (Weiss et al., 2000; Combal et al., 2002) or the tree crown transmittance (Sampson and Smith, 1993), seven variables of interest  $X$  are selected to study the variations of  $\beta_{ref}$ : tree Leaf Area Index that is the product between Leaf Area Index of the scene and the vegetation cover of the scene (for simplicity referred in this paper as LAI; Norman and Welles, 1983), Average Leaf Angle (ALA) defined for an ellipsoidal angle distribution (Campbell, 1990), percentage of holes in the tree crown (POROSITY) approximating somehow the clumping effect, Leaf Optical Properties (LOP), ground reflectance (GROUND), sun zenith angle (SUN) and atmospheric visibility (VISI). Each variable is tuned between 2 and 10 values according to its sensitivity. The ground and trunk optical properties come from the DART spectral database while the leaf optical properties come from the ANGERS03 spectral database (Jacquemoud et al., 2003). The ground surface is assumed to be asphalt or grass (Fig. 7). Three representative urban tree species were chosen: liquidambar "liquidambar styraciflua", for its mean leaf optical properties, and oak "quercus palustris" and poplar "populus alba", for their extreme optical properties (Fig.7).



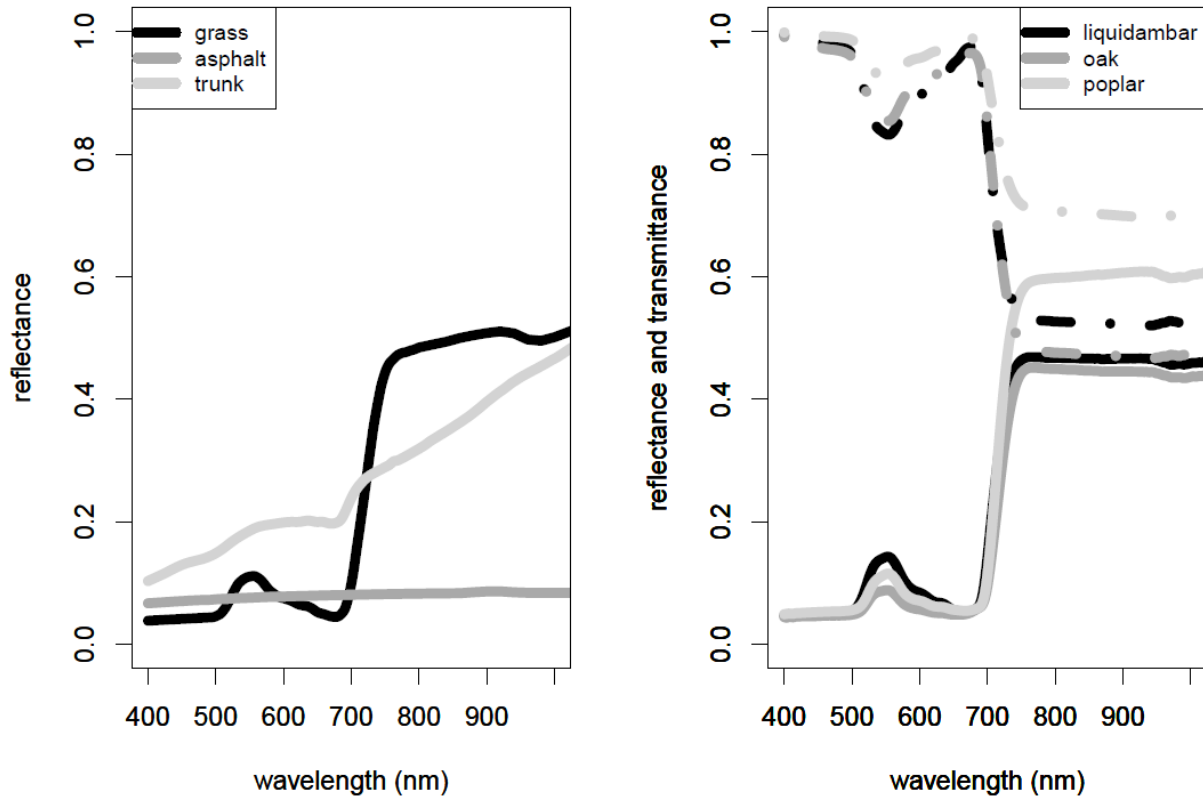


Fig. 7. Optical properties of scene components: two ground types (asphalt and grass) and trunk (left), leaves for the "reference tree model" (right: reflectances are in solid lines and transmittances are in dashed lines).

A full factorial design was carried out to study the impact of each independent variable  $X$ , individually or in interactions with the others, on the variations of  $\rho$  (Droesbeke et al., 1997). DART simulated a total of 3240 scenarios, corresponding to top-of-canopy hyperspectral images with 110 spectral bands. It provided the radiative quantities required to compute  $\rho$  per ground pixel in tree shadow. Mean values of  $\rho$  were stored in a look-up table and used to perform a global sensitivity analysis to find out the major variables  $X'$  for determining  $\rho$ . A variance analysis (ANOVA) with a linear relationship between  $\rho$  and the variables  $X$  was performed to compute a sensitivity index noted  $\eta^2$ . This is the ratio "sum of squares values accounting for the single and combined effects of the variables on the variance of  $\rho$ " over "total sum of square values" (Monod et al., 2006; Olejnik and Algina, 2003). SUN and LAI are the major variables  $X'$  because they give the highest values of  $\eta^2$  (cf. Appendix A). SUN being usually known (e.g. from date, time and location), the issue is to estimate the LAI, which is therefore discussed below.

### 386 3.4.1.2. Tree LAI estimation

1 387

3 388 Tree LAI can be estimated through the use of spectral vegetation indices from which  
4 NDVI is the most used (Colombo et al., 2003 ; Jensen et al., 2012). An empirical LAI-NDVI  
5 389 relationship is built based on a Beer-Lambert exponential regression model with 3 coefficients  
6  
7 390 (Baret and Guyot, 1991):  
8  
9 391

10 392

$$13 393 NDVI = NDVI_{\infty} + (NDVI_g - NDVI_{\infty}) \cdot \exp^{-k_{NDVI} \times LAI} \quad (9)$$

14 394

16 395 where  $NDVI_g$  is the NDVI value for a bare soil (i.e. LAI equals zero),  $NDVI_{\infty}$  is the  
17 asymptotic value of NDVI if LAI tends to infinite and  $k_{NDVI}$  is the extinction coefficient.  
18 396  
19

20 397

22 398 The training data is provided by the design of experiments. For each DART scenario  
23 with a fixed LAI value, the NDVI is computed as the mean over a mask of 6×6 pixel grid  
24 399 centred at the canopy treetop. Then for each scenario out of the total of 324 run with DART,  
25 400 10 pairs of LAI and NDVI are available. However, the estimation of the coefficients of the  
26 regression model in Eq.9 depends on the 6 remaining variables of  $X$  from the design of  
27 401 experiments (ALA, POROSITY, LOP, GROUND, SUN, VISI). Except when  $SUN = 60^{\circ}$   
28 (high solar incidence angle leading to odd fits), performance of the built regression models  
29 402 gave coefficients of determination  $R^2 > 0.87$  and root mean square errors  $RMSE < 0.37$  in the  
30 estimated LAI.  
31 403  
32  
33 404  
34  
35 405  
36  
37 406

38 407

39 408 Then, regression models are applied in the NDVI image and the NDVI value for each  
40 tree is computed as a mean over a 3×3 pixel grid centred at the treetop (grid size can be  
41 chosen manually). In practice, due to the difficulty to have a priori knowledge about the  
42 409 variable values (ALA, POROSITY, LOP, GROUND, SUN, VISI) for each tree, they are  
43 arbitrarily fixed to their average values : ALA =  $57^{\circ}$  (close to the common spherical  
44 410 distribution), POROSITY = 0% (uniform leaf spatial distribution), LOP = liquidambar,  
45 411 GROUND = asphalt, SUN =  $45^{\circ}$  and VISI = 23km (good visibility).  
46 412  
47  
48 413  
49  
50 414

51 414

### 53 415 3.4.1.3. Multivariate regression analysis

54 416

56 417 From the previously determined major variables  $X'$  (i.e. SUN and LAI), a multivariate  
57 linear regression model is built to estimate the reference correction factor  $\beta_{ref}$  by using a  
58  
59 418

60

61

62

63

64

65

stepwise strategy in order to decrease the number of terms in the regression expression (Burnham and Anderson, 2004). A second degree polynomial expression with first order interactions between  $X'$  (LAI, SUN) is chosen at first. After some tests, the following reduced equation was chosen for all spectral bands:

$$Y(\lambda) = a_0 + X'_1 \cdot (a_1 + a_2 \cdot X_1'^2 + a_3 \cdot X_1'^3) + X'_2 \cdot (a_4 + a_5 \cdot X_2') + a_6 \cdot X'_1 \cdot X_2' + a_7 \cdot X_2' \cdot X_1'^2 + a_8 \cdot X_1'^2 \cdot X_2'^2$$

$$\text{with } \begin{cases} X'_1 = e^{-0.5 \cdot LAI} \\ X'_2 = \cos(SUN) \\ Y = \arcsin(\sqrt{\beta_{ref}}) \end{cases} \quad (10)$$

The 9 regression coefficients  $a_i$  were bootstrapped over 1000 samples and their mean values were the coefficients of the final expression in Eq. 10. The confidence intervals for the bootstrap fit of Eq. 10 were:  $0.87 \leq R^2 \leq 0.93$  and  $5.3\% \leq RMSE \leq 8.3\%$  ( $n = 2592$ ). The estimated  $\beta_{ref}$  corresponds to the ratio between  $I_{trans}$  and  $I_{tot}$  (Eq. 6). For instance for a sun zenith angle of  $55^\circ$ , its values reach more than 40%, and have a monotonous increase towards NIR bands for very low LAI values ( $LAI \leq 1$ ; Fig. 8).  $I_{trans}$  is mainly dominated by the contribution of  $I_{trans}^{dir}$  due to few light interactions with tree crown elements (Eq.4). The more the LAI increases, the more  $\beta_{ref}$  values have a curvature at red-edge position between 700nm and 800nm. This emphasizes the contribution of  $I_{trans}^{dif}$  in addition to  $I_{trans}^{dir}$  in  $I_{trans}$ . As a matter of fact, this spectrally-dependant feature of  $\beta_{ref}$  is consistent with the leaves optical property features (Fig.7). Hence with the strong light multiple scattering within the tree crown,  $\beta_{ref}$  values account less than 10% for very high LAI values ( $LAI \geq 5$ ; Fig. 8).

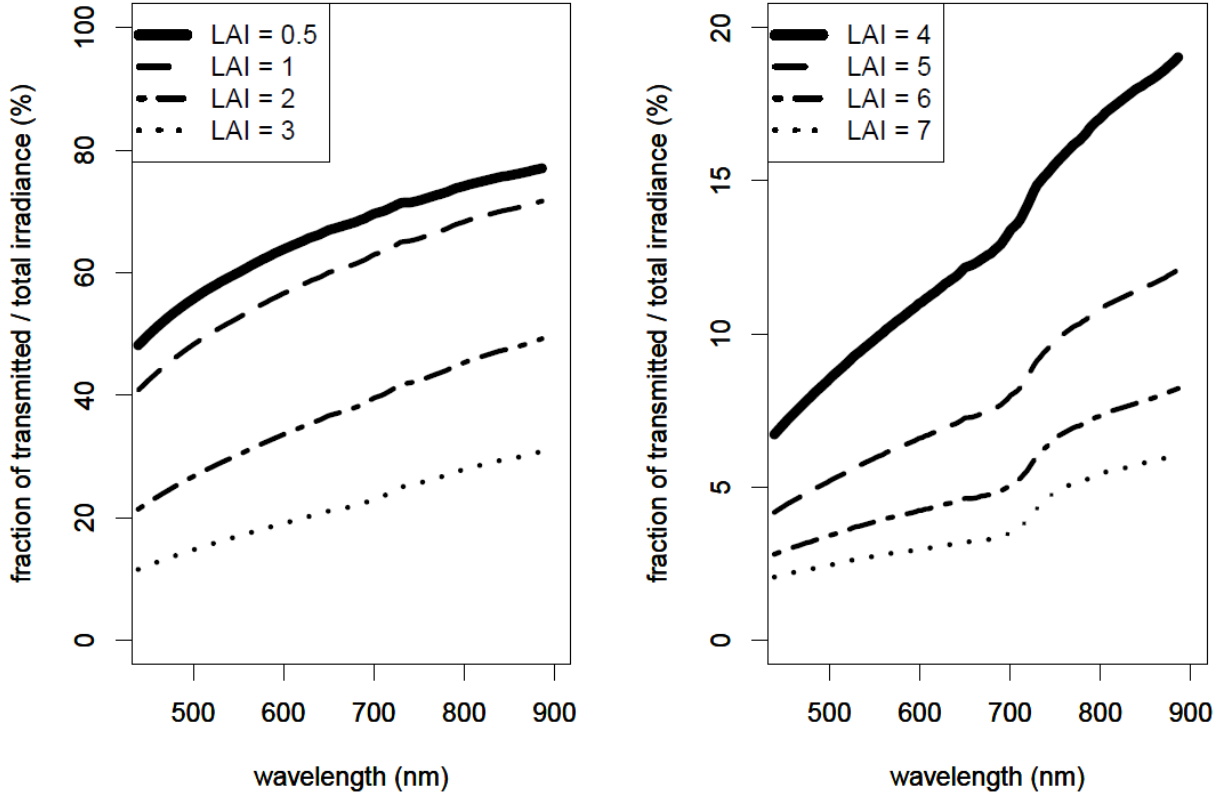


Fig. 8. Reference correction factor expressed in percentage (i.e.  $\beta_{ref}$ ) for different LAI values and for a zenith angle of  $55^\circ$ .

### 3.4.2. Tree viewing solid angle

Once the reference correction factor  $\beta_{ref}$  is estimated for each tree, a pixel-based spatial correction factor is needed to account for the real dimensions of the tree compared to the one used as a "reference tree model" in the design of experiments with DART. In a real scene, each point in the shade views a specific part of the tree; the closer the shaded point is to the tree position, and the larger the occultation is. This occultation is represented by the solid angle  $\Omega$  under which the tree crown is seen. For simplicity, each tree crown is modelled as an elliptic shape (Fig. 5b). However, the mathematical expression of  $\Omega$  is not straightforward and is further detailed in Appendix B. Then, the spatial correction factor is the ratio of  $\Omega$  for the real tree in the image over  $\Omega_{ref}$  for DART "reference tree model" (see Eq. 6).  $\Omega$  values usually ranges between 0 and  $\pi$  in steradian unit.  $\Omega_{ref}$  equals to 0.4sr.

### 3.5. Tree shadow reflectance correction

ICARE-VEG corrects the ICARE reflectance of any pixels in a tree shadow by a specific factor  $\beta$  (see Eq. 6). Other pixels are not corrected. In order to compare ICARE and ICARE-VEG performances, the Mean Absolute Error (MAE) in retrieved reflectance in tree shadows, i.e.  $\rho_{ICV}$ , is compared with ground truth measurements when they are available, or ICARE sunlit retrieved reflectance of the same material type over another area, i.e.  $\rho_{ref/IC}$ , such as:

$$MAE = \frac{1}{N} \times \sum_{i=0}^N |\rho_{ICV}(\lambda_i) - \rho_{ref/IC}(\lambda_i)| \quad (11)$$

with  $N$  the number of spectral bands.

The threshold for best MAE accuracy is set to 0.04 according to the performance of ICARE (Lachérade et al., 2008). A second metric is used, the spectral angle mapper (SAM; Kruse et al., 1993), to inform about the spectral distortions in the retrieved reflectance. It is a similarity spectral index independent of illumination and shadowing conditions. It requires computing the spectral angle  $\alpha$  between the reference reflectance, i.e.  $\rho_{ref/IC}$ , and the retrieved reflectance, i.e.  $\rho_{ICV}$ :

$$\alpha = \cos^{-1} \left( \frac{\sum_{i=1}^N \rho_{ref/IC}(\lambda_i) \cdot \rho_{ICV}(\lambda_i)}{(\sum_{i=1}^N \rho_{ref/IC}^2(\lambda_i))^{1/2} \cdot (\sum_{i=1}^N \rho_{ICV}^2(\lambda_i))^{1/2}} \right) \quad (12)$$

The lower  $\alpha$  value is, the more similar the spectral shape is between the reference and ICARE-VEG retrieved reflectances.

## 4. Experimental data

ICARE-VEG was validated by using the data collected on October 24<sup>th</sup> 2012 over Toulouse, France, from the UMBRA campaign (Urban Material characterization in the sun and shade of Built-up structures and trees and their Retrieval from Airborne image acquisitions over two French cities; Adeline et al., 2013b).

### 4.1. Airborne hyperspectral data

490 Airborne hyperspectral images were acquired with the push-broom sensor HySpex-  
1 491 VNIR1600 (NorskElektroOptikk) with 160 bands in the spectral range 0.4-1 $\mu$ m and a spectral  
2  
3 492 resolution of 3.7nm. For further analysis, 22 spectral bands are kept after removing low  
4  
5 493 instrumental signal-to-noise ratio and water vapour atmospheric windows, and after spectral  
6  
7 494 aggregation at 18nm to be compatible with ICARE running with 6SV code. The acquisitions  
8  
9 495 were at Nadir with a ground spatial resolution of 0.8 m. In addition, a DSM was derived by  
10  
11 496 multi-stereoscopic acquisitions from a panchromatic camera with a horizontal accuracy of  
12  
13 497 0.12 m (Pierrot-Deseilligny and Paparoditis, 2006). The aerial images were manually  
14  
15 498 georeferenced based on the DSM. More than 20 ground control points were selected with the  
16  
17 499 use of the ENVI software and the precision accuracy was inferior to the pixel size. At last, the  
18  
19 500 images were radiometrically corrected with in-lab sensor calibration coefficients.

20 501 Three images were studied and extracted, namely image U1, U2 and U3 (Fig. 9). They  
21  
22 502 corresponded respectively to an acquisition time of 12h40UTC for U1 and U2, and  
23  
24 503 11h30UTC for U3, with a solar zenith and azimuth angles of respectively (57.2°; 198.1°) for  
25  
26 504 U1 and U2, and (55.5°; 177.5°) for U3. They induced large shadows on aerial images  
27  
28 505 specifically in urban areas. The image U1 contains 27% of shaded pixels, 34% for U2, and  
29  
30 506 finally 30% for U3. The images U1 and U2 are located on a sports centre, and are largely  
31  
32 507 dominated by vegetated areas, both well maintained grass lawns and isolated trees, with  
33  
34 508 sports infrastructures. They are characteristics of open areas whereas image U3 is oppositely  
35  
36 509 representative of dense urban areas with high buildings and tree rows alongside the "canal du  
37  
38 510 Midi".

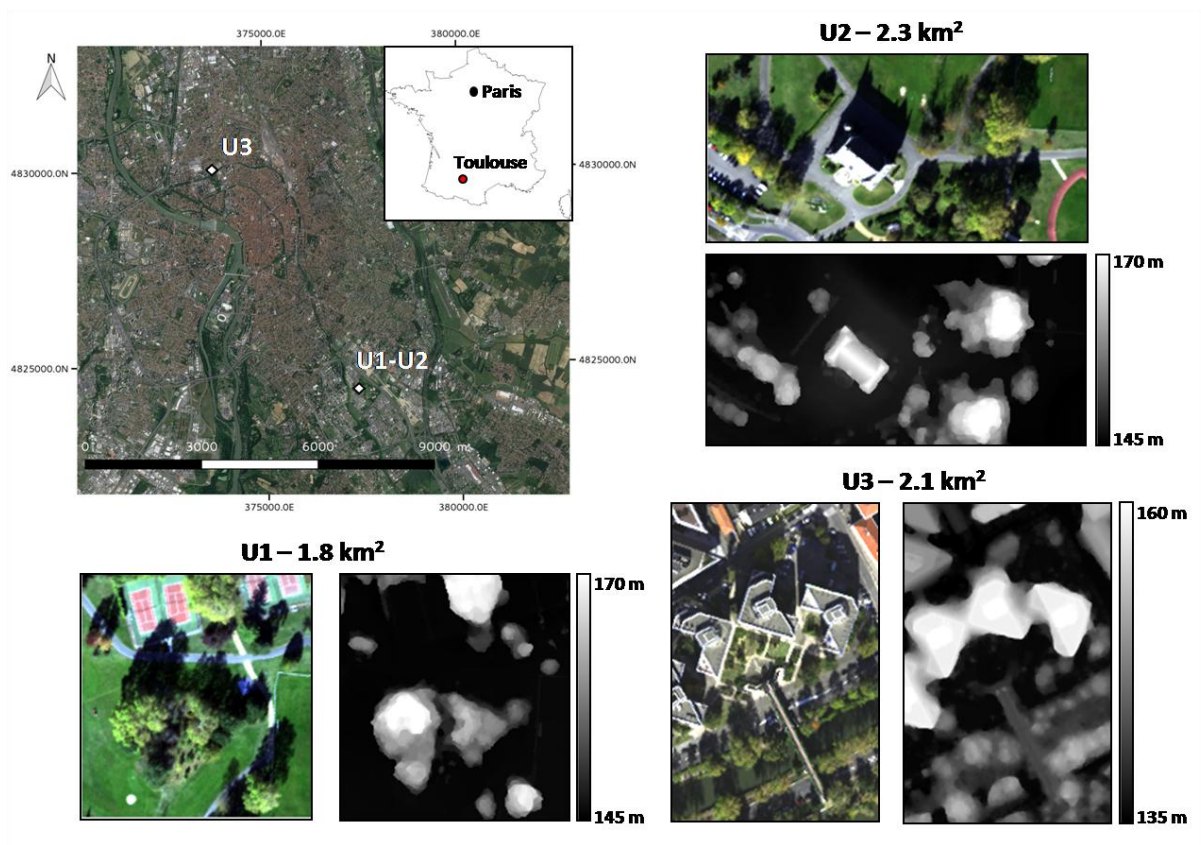


Fig. 9. RGB composite images used in this study associated with their greyscale DSM and their location on a Google Earth image over Toulouse, France.

#### 4.2. Field measurements and atmospheric conditions

Road asphalt and grass surface reflectance were measured over the spectral range 0.35-1.0 $\mu$ m at 3nm spectral resolution and 1nm spectral sampling interval with a portable ASD (Analytical Spectral Devices Inc., Boulder, CO, USA) spectroradiometer and a reflectance plate Spectralon® of known reflectance. The integrated water vapor content and the aerosol type and abundance were measured with a microwave radiometer and a sunphotometer from AERONET ([AERosol RObotic NETwork](#)).

### 5. Results and discussion

ICARE-VEG is applied on the three images described in section 4. Results are discussed for each processing step, then ICARE-VEG performance is compared with those of ICARE in tree shadows and with ground truth.

531 *5.1. Image processing steps performed on trees and their shadows*

1 532  
2  
3 533 Tree crown delineation and tree shadow detection (sections 3.2 and 3.3, cf. Fig. 2) are  
4 the most critical steps in ICARE-VEG since a tree-specific correction is further applied  
5 534 accounting for each tree dimensions and position relatively to the location of the shaded  
6 pixels.  
7 535  
8  
9 536

10 537 For tree crown delineation, the adjacency criterion was set to 5 pixels (i.e. 4 m) for U2  
11 and U3 images, and to 4 (i.e. 3.2m) for U1. The percentage of canopy pixels in the shade was  
12 538 set to 80% (except for U3, 70%), the minimum number of pixels per tree to 40 pixels, and the  
13 tree minimum height to 5m. The DSM of U1 and U3 images was smoothed with a 2×2 size  
14 539 Gaussian filter. From the original images in Fig. 11a, results of NDVI images and histogram  
15 thresholding are shown in Fig. 10a and 10c, leading to the tree label masks shown in Fig. 11b.  
16 540 Some advantages and drawbacks can be pointed out:  
17  
18 541  
19  
20 542  
21  
22 543

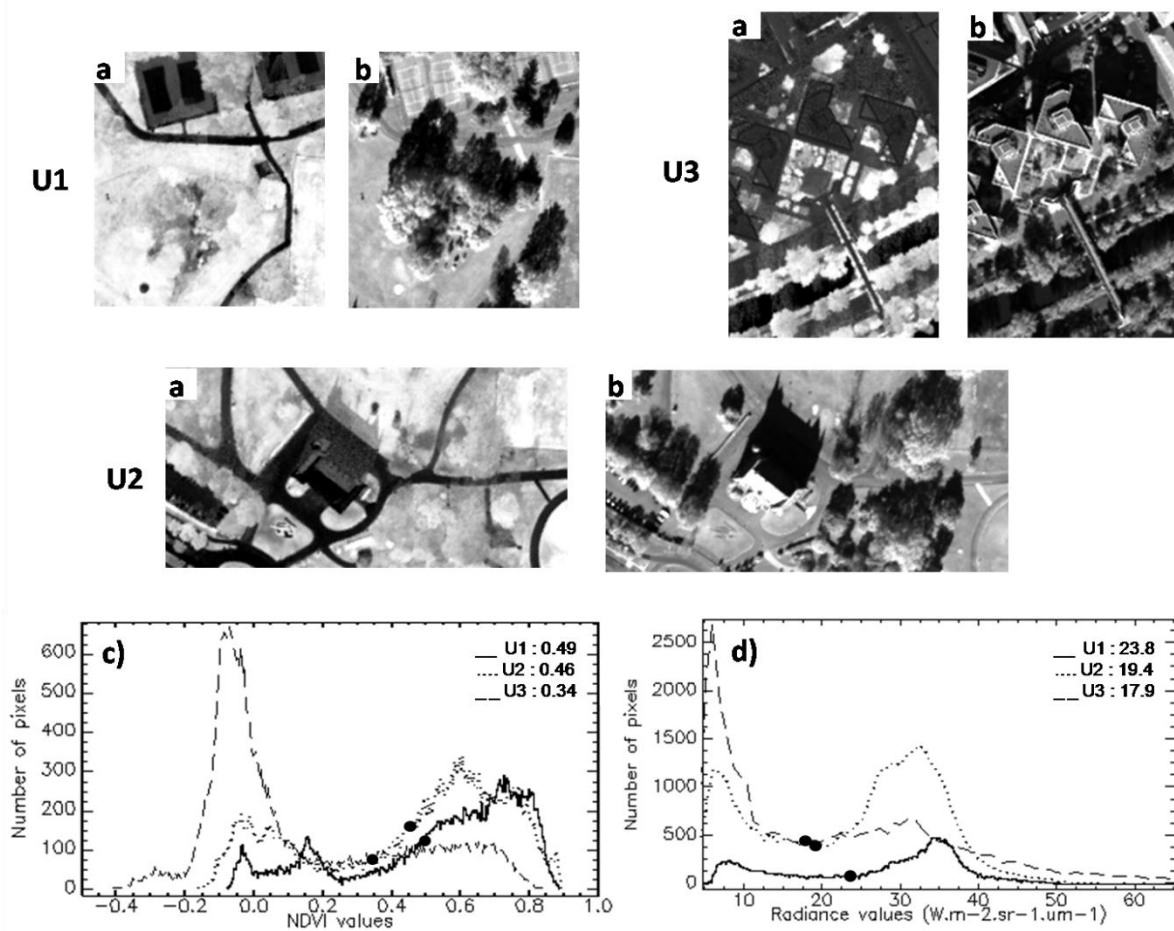
23 544 (i) Vegetation detection with NDVI is often limited by changes in tree phenology, age  
24 and health (e.g. senescent leaves, diseases), and also by top of canopy anisotropic directional  
25 545 reflectance behavior. The UMBRA campaign took place at the early autumn season (Fig.  
26 546 11a). Then, LAI of deciduous trees was falling, inducing a decrease in NDVI and sometimes  
27 tree under-detection (trees located at bottom of U1 and middle of U2 have mean NDVI values  
28 of 0.40 and 0.44, below the thresholds of 0.49 and 0.46: Fig.10c and Fig. 11b). Furthermore,  
29 547 the presence of a large vegetation fraction in the image (e.g. both grass and trees) produces an  
30 irregular shaped NDVI histogram, thus impacting the bimodal thresholding step (U1: Fig.  
31 548 10c). As a perspective, a combination of vegetation spectral indices is recommended for a  
32 better discrimination with artificial materials (Iovan et al, 2014).  
33  
34 550  
35  
36 551  
37  
38 552  
39  
40 553

41 554 (ii) Topography is assumed to be flat, which induces tree misdetection when local  
42 variations occur (vegetated hedges on a bridge, U3: Fig. 11b). Moreover, DSM accuracy may  
43 555 be degraded next to sudden slope changes (lawn close to high buildings, U3: Fig. 11b).  
44 However, these errors are generally corrected during the shadow detection step, since no  
45 556 shadow is usually associated to the false detected trees (e.g. false detection of grass as trees).  
46  
47 557  
48  
49 558  
50

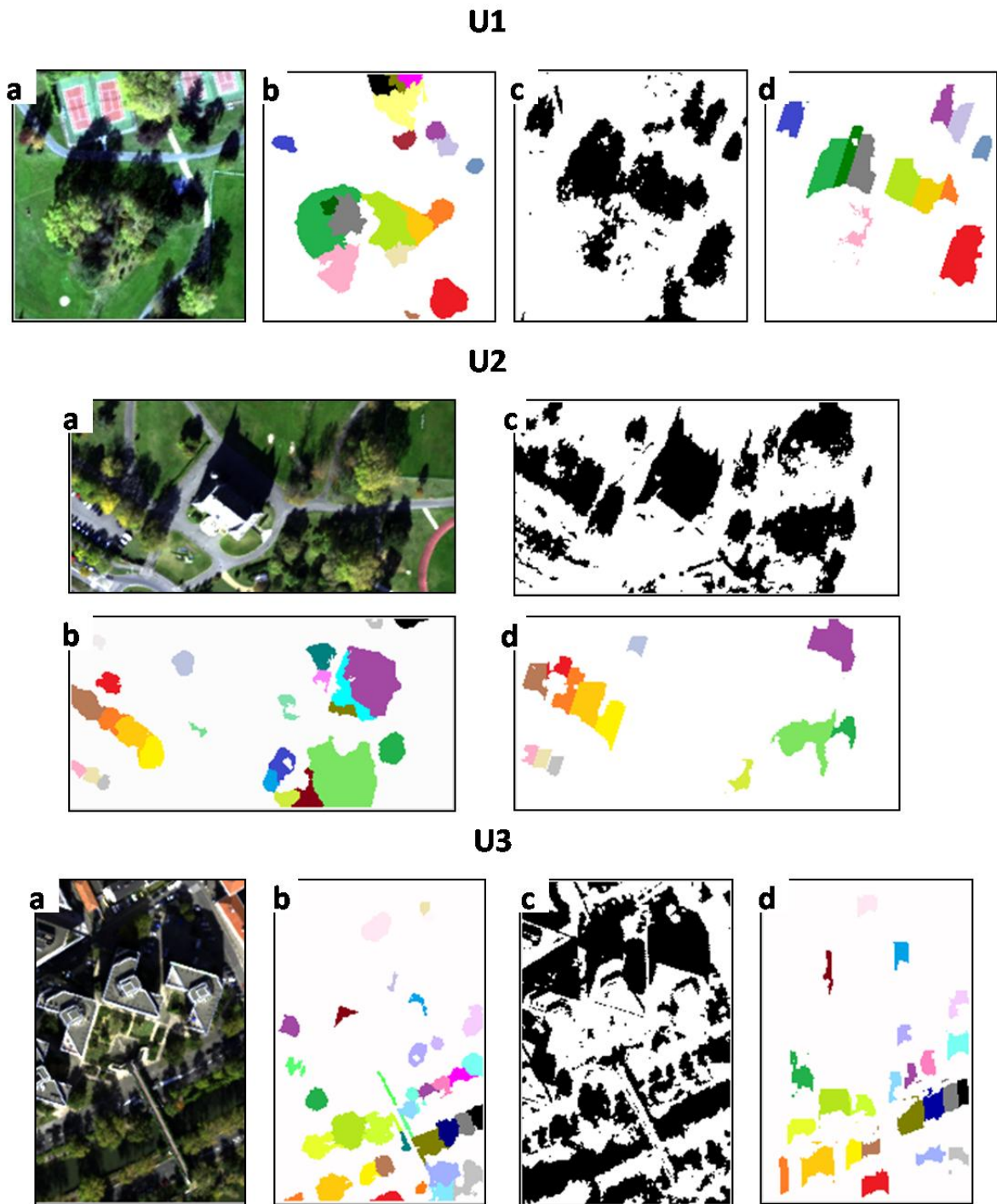
51 559 (iii) The delineation of each tree crown is straightforward for isolated trees. For  
52 instance, good performances are achieved for trees in rows (left in U2 and along the canal in  
53 560 U3: Fig. 11b). Difficulties arise in presence of clustered trees (centre and top-left of U1 and on  
54 the right of U2, Fig. 11b) and pruned trees (middle-right of U3: Fig. 11b), sometimes due to  
55 561 the presence of homogeneous canopies or a lack in height variation among trees (Zheng et al.,  
56 562 2016).  
57  
58 563  
59  
60 564



565 For tree shadow detection, the minimum number of pixels for a tree shadow was set to  
 566 100. From the original images in Fig. 11a, results of intensity images and histogram  
 567 thresholding are shown in Fig. 10b and 10d, leading to the global shadow masks shown in  
 568 Fig. 11c, and finally to the tree label shadow masks in Fig. 11d. Usually urban scenes contain  
 569 a high percentage of shadows, which makes easier the thresholding on the intensity image  
 570 based on a bimodal histogram. However, dark materials in sunlit regions and bright materials  
 571 in shaded regions may be falsely detected as shadows (Adeline et al., 2013a). To address  
 572 these problems, the thresholding method of Nagao (1979) is used to remove water bodies  
 573 (canal detected in U3 without shadow detection: Fig. 11c) and the morphological closing filter  
 574 homogenizes shaded regions (white road lines and cars, U3: Fig. 11c). In the tree label  
 575 shadow masks, the method visually performs well for trees in rows and less for clustered trees  
 576 such as observed before. In some cases, the tree shadow is truncated or under-detected due to  
 577 a local less accurate DSM horizontal and vertical description (tree in row at bottom-left in U3  
 578 and the clustered tree at middle-left in U1: Fig. 11d).



581 Fig. 10.a) NDVI images, b) intensity images, c) NDVI histograms and d) intensity histograms  
 582 (black dots indicates thresholds values).  
 583



584 Fig. 11. a) RGB composite images, b) tree label masks, c) global shadow masks before  
 585 applying the morphological filter and d) tree shadow label masks.  
 586  
 587

LAI and tree viewing solid angle estimation (sections 3.4.1.2 and 3.4.2, cf. Fig. 2) are the last steps required to compute the final physics-based correction factor  $\beta$  of ICARE-VEG.

For LAI estimation, the application of the LAI-NDVI regression model to the images shows the diversity of low estimated LAI values during the start of the fall season (Fig. 12). Without ground truth measurements, no validation can be performed. But on visual examination and by knowledge about the study site, qualitative comparison from one LAI to another seems correct if LAI values are not extreme (LAI close to 0 or superior to 4). Their values range is  $0.77\text{-}2.35\text{m}^2\cdot\text{m}^{-2}$  for U1,  $0.63\text{-}2.06\text{m}^2\cdot\text{m}^{-2}$  for U2 and  $0.61\text{-}2.21\text{m}^2\cdot\text{m}^{-2}$  for U3. Improvements can be investigated in the future by adding the contribution of textural indices or geostatistical information in cases of heterogeneous and patchy spectral information over tree crowns (Colombo et al., 2003).

Finally for tree viewing solid angle estimation,  $\Omega$  is computed for every pixel in each tree shadow. Its mean value is 0.16sr for U1 and U2, and 0.18sr for U3 (Fig. 12). For instance for the long cast shadow at the bottom right in U1,  $\Omega$  values range between 2.0sr for the pixel the closest to the trunk and 0.36sr for the pixel the furthest to the trunk.

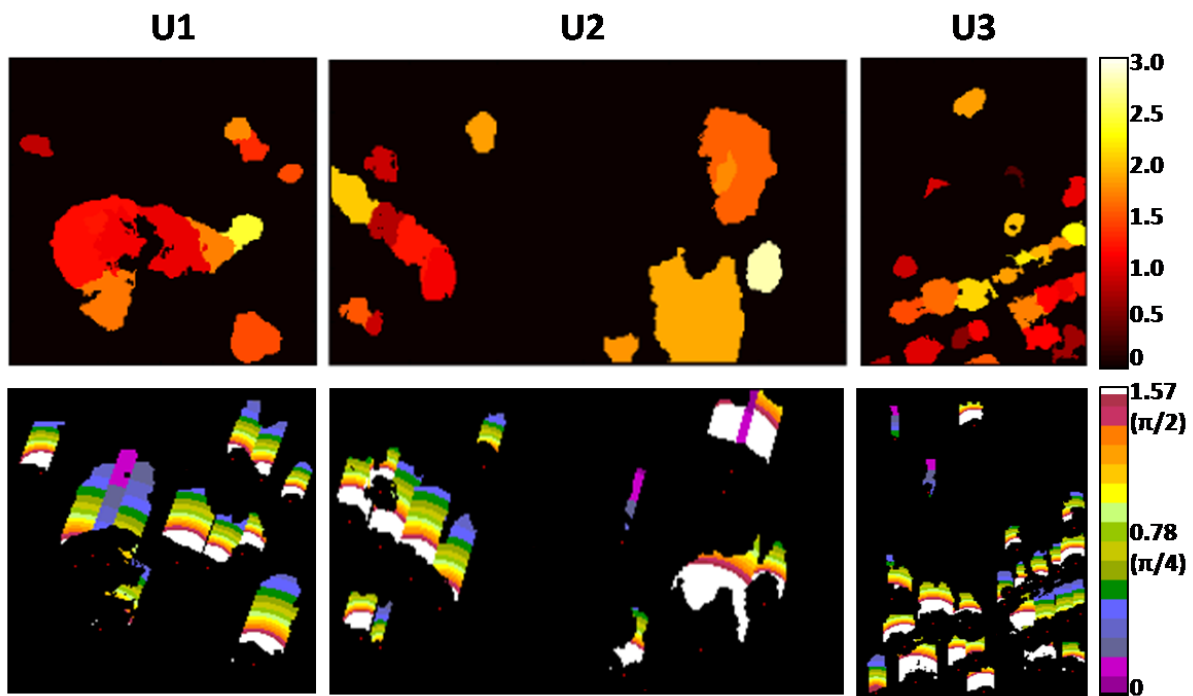


Fig. 12. LAI estimated from the LAI-NDVI regression model (first row) and tree viewing solid angles  $\Omega$  computed in each tree shadow (second row; treetops are indicated in red dots).

## 5.2. Spectral analysis and comparison between ICARE and ICARE-VEG

609

1  
2 610 The improvement of ICARE-VEG over ICARE in tree shaded regions is analyzed for  
3  
4 611 3 types of materials, namely grass (high variable reflectance), asphalt (intermediate flat  
5  
6 612 reflectance), and water (very low reflectance), respectively for 2 trees with different LAI  
7  
8 613 values (Fig. 13). Performances are assessed with the computation of the metrics, MAE and  
9  
10 614 SAM (Eq. 12, Table 2), and by observing the spectral variability in the retrieved reflectance  
11  
12 615 (Fig. 14). The results show that:

13 616  
14 617 (i) the mean reflectance of ICARE in the tree shade is always overestimated compared  
15  
16 618 to its counterpart in the sun. This is strengthened if the material in the shade has a high  
17  
18 619 reflectance (i.e. grass compared to asphalt) and if the LAI is small (since the tree crown  
19  
20 620 transmittance increases; Fig. 13). The MAE for ICARE in the tree shade is at least 4 times  
21  
22 621 higher than the one with ICARE in the sun when compared to the ground truth (Table 2),

23 622 (ii) ICARE retrieved reflectance in the tree shade is distorted from visible to NIR  
24  
25 623 bands, with a spectral increase starting at the red-edge position (particularly more visible for  
26  
27 624 grass). This observation is in line with the previous comments on  $\beta_{ref}$  (Fig. 12). ICARE-VEG  
28  
29 625 correction attenuates this spectral distortion: SAM values are better by a multiplicative factor  
30  
31 626 between 1.0 and 1.4 compared to ICARE (Table 2),

32 627 (iii) ICARE-VEG retrieves lower reflectance values than ICARE, and have a better  
33  
34 628 accuracy due to the correction brought by  $I_{trans}$  : its MAE decreases by a multiplicative  
35  
36 629 factor between 2 and 4.5 when considering ground truth as a reference, and by a  
37  
38 630 multiplicative factor between 4.2 and 18.8 when considering ICARE in the sun as a reference  
39  
40 631 (Table 2). ICARE-VEG correction is spectrally-dependent; it is less notable in the visible  
41  
42 632 range but becomes important in the NIR where ICARE can achieve non physical reflectance  
43  
44 633 values higher than 1 (e.g. grass; Fig. 13a and 13b),

45 634 (iv) The spectral dispersion in ICARE retrieved reflectances increases from sunlit to  
46  
47 635 shaded regions (Fig. 14). This may be due to penumbra and tree clumping effects impacting  
48  
49 636 the spatial homogeneity of the tree shadow at ground. Globally, ICARE-VEG correction  
50  
51 637 reduces this dispersion but not at the same order of magnitude of what ICARE in the sun  
52  
53 638 does,

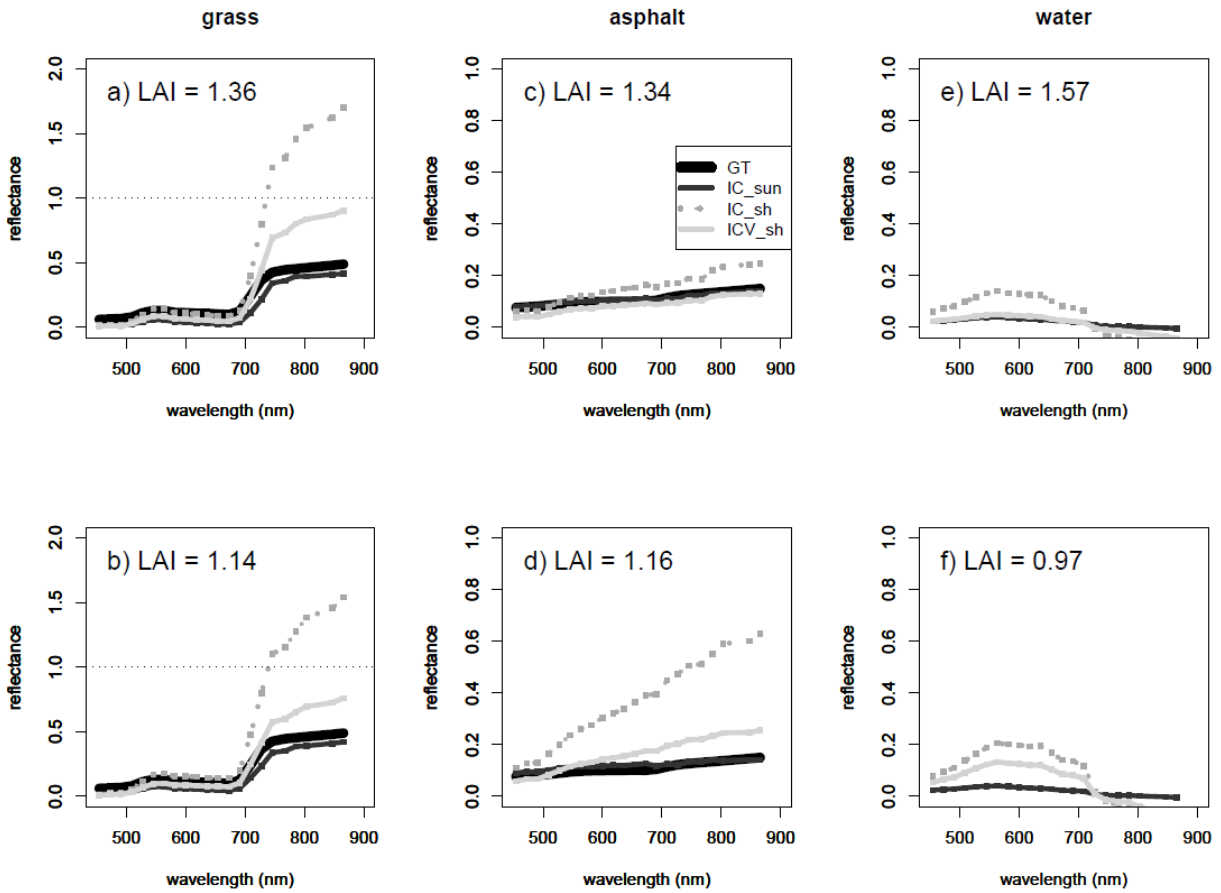
54 639 (v) The correction applied to water is the most challenging because of its very low  
55  
56 640 reflectance, smaller than the 4% threshold in MAE selected as the desired accuracy for  
57  
58 641 atmospheric correction models (Fig. 13). However, ICARE-VEG correction is promising

642 since the order of magnitude in retrieved reflectances is correct as well as its global spectral  
 643 shape,

644 (iv) The spectral differences between ICARE-VEG results and ground truth may be  
 645 explained by the fact that ground truth has been measured close to tree shadow but in the  
 646 sunny part, which induces spectral intra-class variability issue, and  $\beta_{ref}$  factor brings a mean  
 647 correction over the tree shadow, which cannot account for all local variations in tree shadow,  
 648 especially when LAI is low.

649 At last, ICARE and ICARE-VEG are compared for all pixels belonging to the tree  
 650 shadow label mask (U1: 5048 pixels, U2: 3843 pixels, U3: 4034 pixels). In the NIR band at  
 651 800nm, the decrease in the mean ICARE-VEG retrieved reflectance compared to ICARE is  
 652 43.3% for U1, 54.5% for U2 and 36.7% for U3. In the red band at 670nm, this decrease is  
 653 36.4% for U1, 51.8% for U2 and 40.1% for U3. At 800nm, ICARE reflectance is larger than 1  
 654 for 5.9%, 3.6% and 0.3% of pixels for U1, U2 and U3, respectively. ICARE-VEG reduces  
 655 this percentage of pixels to 4.1%, 2.9% and 0.1%, respectively.

656



657

658 Fig. 13. ICARE reflectances in the sun ("IC\_sun") and both ICARE and ICARE-VEG  
 659 reflectances in the shade ("IC\_sh" and "ICV\_sh") for 3 ground materials (grass: first column,  
 660  
 661  
 662  
 663  
 664  
 665

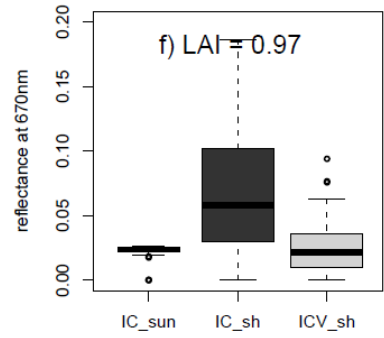
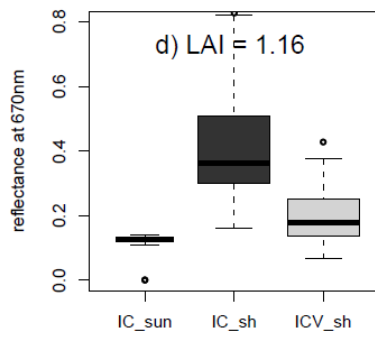
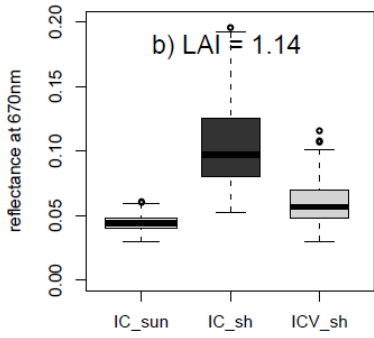
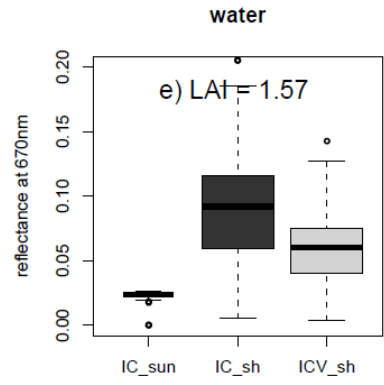
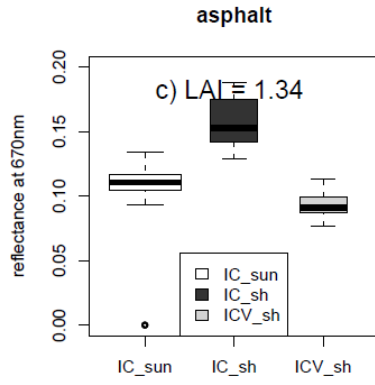
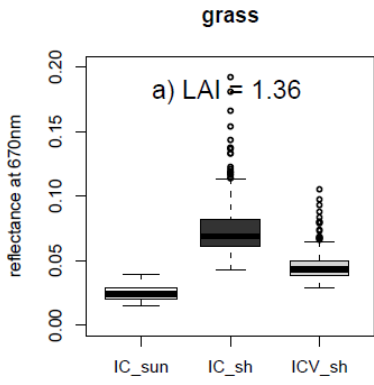
660 asphalt: second column, and water: third column) and for 2 different LAI values (high: first  
 661 row and low: second row). In-situ measurements are also shown when available ("GT" :  
 662 Ground Truth).

663  
 664 Table 2. ICARE and ICARE-VEG performance (MAE : Mean Absolute Error expressed in  
 665 percentage of reflectance unit, and SAM : Spectral Angle Mapper expressed in radian unit)  
 666 for scenarios from a to f (please refer to Fig. 13). Reference reflectance is in-situ  
 667 measurements or ICARE in the sun. Bold numbers indicate MAE values lower than 4%; "-"  
 668 stands for unavailable data.

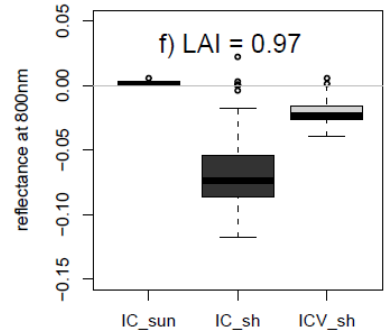
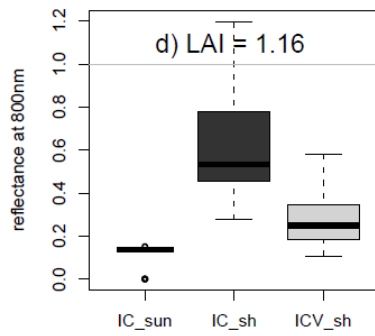
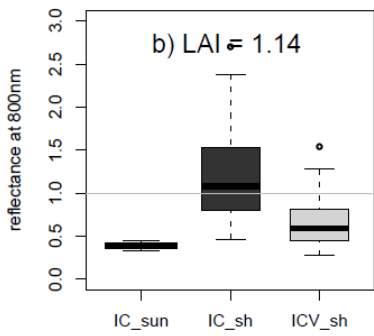
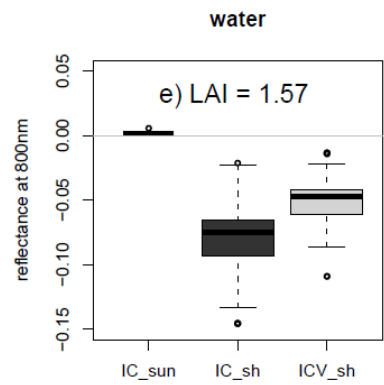
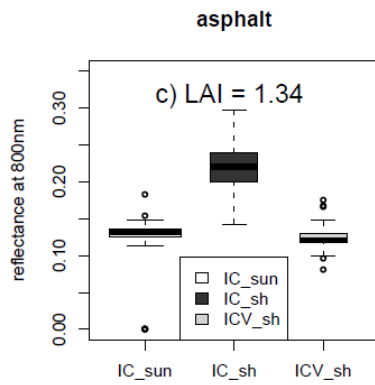
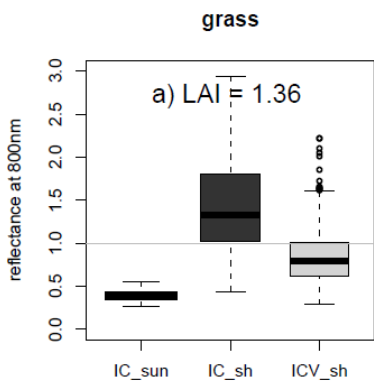
Reference	Test	Metrics	a)	b)	c)	d)	e)	f)
	ICARE (sun)	MAE	7.6%	6.5%	<b>0.5%</b>	<b>1.3%</b>		
		SAM	0.22	0.15	0.05	0.09	-	-
In-situ measurements (sun)	ICARE (shadow)	MAE	31.7%	29.0%	4.6%	25.2%		
		SAM	0.26	0.21	0.17	0.23	-	-
	ICARE-VEG (shadow)	MAE	13.1 %	8.2%	<b>2.3%</b>	5.7%		
		SAM	0.25	0.19	0.13	0.18	-	-
	ICARE	MAE	37.1%	34.2%	4.7%	24.0%	10.6%	7.1%
ICARE (sun)	(shadow)	SAM	0.07	0.07	0.20	0.30	0.37	0.49
	ICARE-VEG (shadow)	MAE	14.2%	10.5%	<b>2.3%</b>	5.1%	6.0%	<b>1.1%</b>
		SAM	0.05	0.05	0.15	0.25	0.34	0.42

669

1  
2  
3  
4  
5  
6  
7  
8  
9  
10  
11  
12  
13  
14  
15  
16  
17  
18  
19  
20  
21  
22  
23  
24  
25  
26  
27  
28  
29  
30  
31  
32  
33  
34  
35  
36  
37  
38  
39  
40  
41  
42  
43  
44  
45  
46  
47  
48  
49  
50  
51  
52  
53  
54  
55  
56  
57  
58  
59  
60  
61  
62  
63  
64  
65



670



671

672 Fig. 14. Reflectance variability in red band (2 first rows) and NIR band (2 last rows) for  
673 ICARE in the sun ("IC\_sun") and both ICARE and ICARE-VEG in the shade ("IC\_sh" and  
674 "ICV\_sh" respectively) for scenarios from a to f (please refer to Fig. 13).

## 676 6. Conclusions

677  
678 ICARE-VEG improves ICARE 3D atmospheric correction in order to correct retrieved  
679 surface reflectances in presence of tree shadows. It includes image-based techniques such as  
680 tree crown delineation and tree shadow detection, and then the application of a spectral and  
681 geometrical physics-based correction factor in tree shadow pixels following each tree crown  
682 characteristics. Since this issue is relatively new, the strategy was based on a complex  
683 exploratory methodology by using the DART 3D canopy radiative transfer model, and heads  
684 towards the development of a semi-automatic method. ICARE-VEG only considers deciduous  
685 trees with green healthy leaves and surfaces with a lambertian spectral behaviour.

686 The application of ICARE-VEG on VNIR hyperspectral high spatial resolution data  
687 and the comparison between ICARE and ICARE-VEG clearly stress that a large inaccuracy  
688 occurs if tree crown transmission is neglected. Globally, results were encouraging and showed  
689 that (i) neglecting the transmitted irradiance demonstrates an over-estimation in retrieved  
690 reflectances, the higher the material reflectance is and the lower the tree LAI is, (ii) this bias  
691 increases from visible to NIR at the red-edge position, which is due to the additive  
692 contribution of the diffuse over the direct transmitted irradiance in the total transmitted  
693 irradiance received at tree shadow; ICARE-VEG attenuated this spectral distortion by a  
694 multiplicative factor between 1.0 and 1.4 by means of spectral angle mapper performance,  
695 (iii) ICARE-VEG improves the mean absolute error in retrieved reflectances compared to  
696 ICARE in tree shadows by a multiplicative factor ranging between 4.2 and 18.8 for some test  
697 cases (taking ICARE in the sun as reference), and (iv) for a given wavelength, the spectral  
698 variability in the retrieved reflectances increases from sunlit to shaded regions due to  
699 penumbra and tree clumping effects, which makes difficult for the ICARE-VEG correction to  
700 exactly reduce at the same order of magnitude of what ICARE does in sunlit regions.

701 These results highlight the complexity to model physical natural processes with finer  
702 spatial resolutions. The difficulty relies on the high number of sources of variability to cope  
703 with, among them, the spectral and spatial dimensions for the tree shadow correction, the  
704 intra-class variability for a given material, and the intrinsic characteristics of urban areas  
705 (Small, 2001).



706 Future work includes the validation of ICARE-VEG in the Short Wave Infrared  
707 Region (SWIR: 1.0-2.5 $\mu$ m), the replacement of 6SV atmospheric code with MODTRAN  
708 (MODerate resolution atmospheric TRANsmission; Berk et al, 1999) in ICARE-HS, and the  
709 comparison of 3D atmospheric codes in urban areas between the fusion of ICARE-VEG and  
710 ICARE-HS and ATCOR-4. Moreover, a better analysis of the direct and diffuse transmitted  
711 irradiance terms in presence of a tree crown is planned to better understand the possible  
712 sources of errors and improvements of ICARE-VEG.

## 714 Acknowledgements

715  
716 This work was funded by ONERA and the French Research Agency in the framework  
717 of the ANR VegDUD proposal studying the role of vegetation in sustainable urban  
718 development. We would like to thank the CESBIO DART team (Nicolas Lauret, Tristan  
719 Gregoire, JérômeCros) for their useful advices and server resources as well as the ONERA IT  
720 department, Benedicte Diez and Sidonie Levebvre (ONERA) and Fabrice Vinatier (LISAH)  
721 for their support about the use of ICARE and statistical issues.

## 723 Appendix A

724  
725 To assess the most influent variables  $X'$ , a global sensitivity analysis based on  
726 ANOVA is applied on a second degree polynomial expression with first order interactions  
727 between the inputs  $X=\{LAI, ALA, POROSITY, LOP, GROUND, SUN, VISI\}$  and the output  
728  $\beta_{ref}$ . For each spectral band, the regression fit between  $X$  and  $\beta_{ref}$  gives:  $R^2 > 0.98$  and p-  
729 value  $< 1\%$ . The sensitivity index  $\eta^2$  is computed for 4 ranges of LAI from the results of  
730 ANOVA: full LAI range (0.5-8), low LAI (0.5-2), medium LAI (2-3.5) and high LAI (3.5-8).  
731 Results are shown in [Table A.1](#).

732  
733 Table A.1. Median values of the sensitivity index  $\eta^2$ , expressed in total percentage accounting  
734 for the contribution of the variable in the variance of  $\beta_{ref}$  computed over the spectral domain  
735 for different LAI ranges and based on ANOVA results. Each single variable represents its  
736 main effect (coefficient of the variable taken alone and squared except for the qualitative  
737 variables: LOP, GROUND, VISI); the interaction effect is the sum of all combinations

738 between the variables; residuals stand for the missing contribution from other variables or  
 739 errors in the fitting regression model of  $\beta_{ref}$ .

Variables (Df) <sup>a</sup>	LAI range			
	$0.5 \leq LAI \leq 8$ (n=3490)	$0.5 \leq LAI \leq 2$ (n=1296)	$2 \leq LAI \leq 3.5$ (n=1296)	$3.5 \leq LAI \leq 8$ (n=1296)
LAI (2)	<b>72.1</b>	<b>41.6</b>	<b>24.1</b>	<b>15.2</b>
ALA (2)	1.5	1.1	5.4	8.5
POROSITY (2)	0.9	0.2	2.3	8.3
LOP (2)	0.0	0.0	0.0	0.0
GROUND (1)	0.0	0.0	0.0	0.0
SUN (2)	<b>18.2</b>	<b>38.1</b>	<b>51.2</b>	<b>50.2</b>
VISI (1)	3.6	13.8	9.1	6.2
Interactions (27)	2.6	3.2	7.1	10.0
Residuals	1.1	2.0	0.8	1.6

<sup>a</sup>Degree of Freedom

740  
741  
742 Whatever the LAI range,  $\eta^2$  values showed few spectral dependence except locally on  
743 the red-edge with around 10% maximum variation (data not shown). In one side for the full  
744 LAI range ( $0.5 \leq LAI \leq 8$ ) and by order of importance, LAI and SUN contribute the most to  
745  $\beta_{ref}$  variance, then VISI, the interactions (mainly dominated by ALA with SUN), ALA,  
746 POROSITY, and at last no contribution for LOP and GROUND. These two last variables  
747 might interfere in the radiative budget (i.e.  $\beta_{ref}$ ) at a second level compared to LAI and SUN  
748 since the contribution of the direct light is predominant over the diffuse light within the  
749 canopy. On the other side, by considering LAI ranges, the more LAI increases, the more the  
750 influence of LAI and VISI is reduced for the increasing benefit of SUN, ALA, the interactions  
751 (e.g. ALA with SUN) and POROSITY. Indeed, increasing tree clumping and both sun zenith  
752 angle and leaf orientation gets more transparency in a very closed canopy (i.e. high LAI).  
753 Finally, LAI and SUN are selected as  $X'$  variables to estimate  $\beta_{ref}$ .

## 754 Appendix B

755  
756  
757 The solid angle viewing a surface situated in the upper space from any point is usually  
758 defined by:

759

$$\Omega = \int_0^{\pi/2} \int_{\varphi_{min}}^{\varphi_{max}} \cos(\theta) \cdot d\varphi \cdot d\theta = \int_0^{\pi/2} \Delta\varphi(\theta) \cdot \cos(\theta) d\theta \quad (\text{B.1})$$

761

762  $\theta$  denotes the elevation angle (which is not the standard notation in spherical  
763 coordinate system), and  $\varphi$  the azimuth angle (anticlockwise from South direction, e.g. X axis).

764  $\Delta\varphi(\theta) = \varphi_{max}(\theta) - \varphi_{min}(\theta)$  is the partial angle of the object for a given  $\theta$  and is set to 0  
765 when the object is out of reach for a given direction  $(\theta, \varphi)$ . However, here the tree crown is  
766 assumed to have an ellipsoid shape (Essery et al., 2008; Fig. 5), hence  $\Delta\varphi(\theta)$  expression is  
767 not trivial to determine and to integrate since it depends on  $\theta$  variations.

768 Let's consider a given point  $C(0,0,0)$  situated in the tree shadow.  $C$  is the centre of the  
769 Cartesian coordinates system. The coordinates of the base of the trunk  $T$  are  $(x_0, y_0, 0)$ , the total  
770 tree height is  $H_{tree}$ , the trunk height  $H_{trunk} = H_{tree}/4$ , the tree crown has a diameter of  $D_{tree}$   
771 and is modelled by an ellipsoid with a revolution symmetry in  $Z$  axis:

772

$$\frac{(x-x_0)^2+(y-y_0)^2}{r_h^2} + \frac{(z-z_0)^2}{r_v^2} = 1 \quad (\text{B.2})$$

774

775 with  $r_h = D_{tree}/2$  denotes the horizontal tree radius of the crown diameter,  $r_v = (H_{tree} -$   
776  $H_{trunk})/2$  is the vertical radius, and  $z_0 = H_{trunk} + H_{tree}/2$  is the altitude of the ellipsoid  
777 centre. For any ray beam emitted from point  $C(0,0,0)$  in a given direction denoted by the  
778 couple of angles  $(\theta, \varphi)$ , the parametric equation is:

779

$$C(l) = \begin{pmatrix} l \cdot \cos(\theta) \cdot \cos(\varphi) \\ l \cdot \cos(\theta) \cdot \sin(\varphi) \\ l \cdot \sin(\theta) \end{pmatrix} \quad (\text{B.3})$$

781

782  $l$  stands for the parametric distance. In order to find the intersection between the beam  
783 and the crown, Eq. B.2 is substituted into Eq. B.3. This gives a quadratic equation with three  
784 coefficients  $a \cdot l^2 + b \cdot l + c = 0$  determined by:

785

$$\begin{cases} a = \frac{\cos^2(\theta)}{r_h^2} + \frac{\sin^2(\theta)}{r_v^2} \\ b = \frac{-2 \cdot \cos(\theta) \cdot (x_0 \cdot \cos(\varphi) + y_0 \cdot \sin(\varphi))}{r_h^2} - \frac{2 \cdot \sin(\theta) \cdot z_0}{r_v^2} \\ c = \frac{x_0^2 + y_0^2}{r_h^2} + \frac{z_0^2}{r_v^2} - 1 \end{cases} \quad (\text{B.4})$$

786

787

788

789

787

788  $\varphi_0$  is defined as the azimuth of point  $T$ . The expression of parameter  $b$  can be  
789 rewritten as follows:

$$b = F_2[\theta] \cdot \cos(\varphi - \varphi_0) + F_3[\theta] \text{ with } \begin{cases} F_2[\theta] = -\frac{2 \cdot \cos(\theta) \cdot \sqrt{x_0^2 + y_0^2}}{r_h^2} \\ F_3[\theta] = -\frac{2 \cdot \sin(\theta) \cdot z_0}{r_v^2} \end{cases} \quad (\text{B.5})$$

791  
792 In order to find only one solution to this quadratic equation, *i.e.* when the ray intersects  
793 the tree crown surface at only one point located at the borders of the tree crown, the equality  
794  $b^2 - 4ac = 0$  must comply with:

$$b = 2\sqrt{ac} = F_1[\theta] = 2\sqrt{\left(\frac{\cos^2(\theta)}{r_h^2} + \frac{\sin^2(\theta)}{r_v^2}\right) \left(\frac{x_0^2 + y_0^2}{r_h^2} + \frac{z_0^2}{r_v^2} - 1\right)} \quad (\text{B.6})$$

795  
796 Thus, two solutions are resulting for  $\varphi$ :

$$\varphi = \varphi_0 \pm \Delta\varphi/2 \text{ with } \Delta\varphi = 2 \arccos\left(\frac{F_1[\theta] - F_3[\theta]}{F_2[\theta]}\right) \quad (\text{B.7})$$

797  
798 Since the azimuth of the two borders are symmetric,  $\Delta\varphi$  is centred on the azimuth of  
799 the trunk (*i.e.*  $\varphi_0$ ). By reporting [Eq. B.6](#) and [Eq. B.5](#) in [Eq. B.1](#), the integration will be solved  
800 numerically by using the Riemann integral, further validated with a Monte Carlo method.  $\Delta\varphi$   
801 will be set to 0 when the tree is out of reach, *i.e.* for values of  $\theta$  leading to  $\left|\frac{F_1[\theta] - F_3[\theta]}{F_2[\theta]}\right| > 1$ ,  
802 where the arcs function is not defined.

## 803 REFERENCES

804 Adeline, K.R.M., Chen, M., Briottet, X., Pang, S.K., Paparoditis, N., 2013a. Shadow  
805 detection in very high spatial resolution, aerial images: A comparative study. *ISPRS Journal*  
806 of *Photogrammetry and Remote Sensing* 80: 21–38.

807 Adeline, K., Le Bris, A., Coubard, F., Briottet, X., Paparoditis, N., Viallefont, F., Rivière, N.,  
808 Papelard, J.-P., Déliot, P., Duffaut, J., Airault, S., David, N., Maillet, G., Poutier, L., Foucher,  
809 P.-Y., Achard, V., Souchon, J.-P., Thom, C., 2013b. Description de la campagne aéroportée  
810 UMBRA: étude de l'impact anthropique sur les écosystèmes urbains et naturels avec des

1 817 images THR multispectrales et hyperspectrales. Revue française de photogrammétrie et de  
2 818 télédétection 202: 79–92.  
3 819  
4  
5 820 Adeline, K., Briottet, X., Paparoditis, N., 2012. Material reflectance retrieval in shadow due  
6  
7 821 to urban vegetation from 3D lidar data and hyperspectral airborne imagery. In 32nd EARSeL  
8  
9 822 Symposium and 36th General Assembly, Advances in Geosciences, Mykonos, Greece.  
10 823  
11  
12 824 AErosol RObotic NETwork - AERONET, NASA's Goddard Space Flight Centre,  
13  
14 825 <https://aeronet.gsfc.nasa.gov/>.  
15  
16 826  
17  
18 827 Alonzo, M., Bookhagen, B., RobertsD., 2014. Urban tree species mapping using hyperspectral  
19  
20 828 and lidar data fusion. Remote Sensing of Environment, 148:70–83.  
21  
22 829  
23 830 Baret, F., Guyot, G., 1991. Potentials and limits of vegetation indices for lai and apar  
24  
25 831 assessment. Remote Sensing of Environment, 35(2-3):161–173.  
26  
27 832  
28  
29 833 Berk, A., Anderson, G., Bernstein, L., Acharya, P., Dothe, H., Matthew, M., AdlerGolden, S.,  
30  
31 834 Chetwynd Jr., J., Richtsmeier, S., Pukall, B., Allred, C., Jeong, L., Hoke, M., 1999.  
32  
33 835 MODTRAN4 radiative transfer modeling for atmospheric correction. In Proceedings SPIE  
34  
35 836 Annual Meeting 3756, Denver, CO, pp. 348–353.  
36 837  
37  
38 838 Burnham, K., Anderson, D. R., 2004. Multimodel inference understanding aic and bic in  
39  
40 839 model selection. Sociological Methods & Research, 33(2):261–304.  
41  
42 840  
43 841 Campbell, G., 1990. Derivation of an angle density function for canopies with ellipsoidal leaf  
44  
45 842 angle distributions. Agricultural and Forest Meteorology, 49(3): 173–176.  
46  
47 843  
48  
49 844 Ceamanos, X., Briottet, X., Roussel, G., GilardyH., Adeline, K., 2017. Using 3D information  
50  
51 845 for atmospheric correction of airborne hyperspectral images of urban areas. 2017 Joint Urban  
52  
53 846 Remote Sensing Event (JURSE), Dubai, pp. 1-4.  
54  
55 847  
56 848 Chen, M., Seow, K. L. C., Briottet, X., Pang, S. K., 2013. Efficient empirical reflectance  
57  
58 849 retrieval in urban environments. IEEE Journal of Selected Topics in Applied Earth  
59  
60 850 Observations and Remote Sensing, 6(3) : 1596-1601.

851

1 852 Colombo, R., Bellingeri, D., Fasolini, D., Marino, C. M., 2003. Retrieval of leaf area index in  
2  
3 853 different vegetation types using high resolution satellite data. *Remote Sensing of*  
4  
5 854 *Environment*, 86(1): 120-131.

6  
7 855

8  
9 856 Combal, B., Baret, F., Weiss, M., Trubuil, A., Mace, D., Pragnere, A., Myneni, R.,  
10  
11 857 Knyazikhin, Y., Wang, L., 2002. Retrieval of canopy biophysical variables from bidirectional  
12  
13 858 reflectance - using prior information to solve the ill-posed inverse problem. *Remote Sensing*  
14  
15 859 *of Environment*, 84(1):1-15.

16 860

17  
18 861 Damm, A., Guanter, L., Verhoef, W., Schläpfer, D., Garbari, S., Schaepman, M.E.,  
19  
20 862 2015. Impact of varying irradiance on vegetation indices and chlorophyll fluorescence derived  
21  
22 863 from spectroscopy data, *Remote Sensing of Environment*, 156 : 202-215.

23 864

24  
25 865 Dare, P., 2005. Shadow analysis in high-resolution satellite imagery of urban areas.  
26  
27 866 *Photogrammetric Engineering and Remote Sensing*, 71:169-177.

28  
29 867

30  
31 868 Dell'Acqua, F., Gamba, P., Lisini, G., 2005. Urban land cover mapping using hyperspectral  
32  
33 869 and multispectral vhr sensors: spatial versus spectral resolution. In *Proc. URBAN, IAPRS*,  
34  
35 870 volume XXXVI-8/W27, Tempe, AZ, USA.

36 871

37  
38 872 Dreesbeke, J.-J., Saporta, G., Fine, J., and Société de statistique Association pour la  
39  
40 873 statistique et ses utilisations en France. *Plans d'expériences: applications à l'entreprise*.  
41  
42 874 Editions TECHNIP.

43 875

44  
45 876 Duffaut, J. and Déliot P., 2005. Characterization and calibration of a high-resolution multi-  
46  
47 877 spectral airborne digital camera. *Optical Complex Systems*, Marseille (France), October 24,  
48  
49 878 2005.

50  
51 879

52  
53 880 Essery, R., Bunting, P., Rowlands, A., Rutter, N., Hardy, J., Melloh, R., Link, T., Marks, D.,  
54  
55 881 Pomeroy, J., 2008. Radiative transfer modeling of a coniferous canopy characterized by  
56  
57 882 airborne remote sensing. *J. Hydrometeor*, 9: 228-241.

58 883

59

60

61

62

63

64

65

884 Gamon, J., Penuelas, J., Field, C., 1992. A narrow-waveband spectral index that tracks diurnal  
1 885 changes in photosynthetic efficiency. *Remote Sensing of environment*, 41: 35-44.  
2  
3 886  
4  
5 887 Gastellu-Etchegorry, J.-P., Demarez, V., Pinel, V., Zagolski, F., 1996. Modeling radiative  
6 888 transfer in heterogeneous 3-d vegetation canopies. *Remote Sensing of Environment*, 58(2):  
7 889 131–156.  
8  
9 890  
10  
11 891 Iovan, C., Courneade, P.-H., Guyard, T., Bayol, B., Boldo, D., Cord, M., 2014. Model-Based  
12 892 Analysis–Synthesis for Realistic Tree Reconstruction and Growth Simulation. *Geoscience  
13 and Remote Sensing, IEEE Transactions on*, 52(2): 1438-1450.  
14  
15 893  
16 894  
17  
18 895 Jacquemoud, S., Bidel, L., François, C., Pavan, G., 2003. ANGERS leaf optical properties  
19 896 database, Angers, France, June 2003, <http://opticleaf.ipgp.fr/index.php?page=database>.  
20  
21  
22 897  
23  
24 898 Jensen, J., Cowen, D., 1999. Remote sensing of urban/suburban infrastructure and  
25 899 socioeconomic attributes. *Photogrammetric Engineering and Remote Sensing*, 65:611–622.  
26  
27 900  
28  
29 901 Jensen, R. R., Hardin, P. J., Hardin, A. J., 2012. Estimating Urban Leaf Area Index (LAI) of  
30 902 Individual Trees with Hyperspectral Data. *Photogrammetric Engineering & Remote Sensing*,  
31 903 5(10): 495-504.  
32  
33 904  
34  
35 905 Kruse, F. A., Lefkoff, A. B., Boardman, J.W., Heidebrecht, K.B., Shapiro, A.T., Barloon, P.J.,  
36 906 Goetz, A.F.H., 1993. The Spectral Image Processing System (SIPS) - Interactive visualization  
37 907 and analysis of Imaging Spectrometer data. *Remote Sensing of Environment* 44: 145 - 163.  
38  
39 908  
40 909 Lachérade, C., Miesch, D., Boldo, X., Briottet, C., Valorge, Le Men, H., 2008. Icare: A  
41 910 physically-based model to correct atmospheric and geometric effects from high spatial and  
42 911 spectral remote sensing images over 3d urban areas. *Meteorology and Atmospheric Physics*,  
43 912 102(3-4):209–222.  
44  
45 913  
46  
47 914 Liow, Y., Pavlidis, T., 1990. Use of shadows for extracting buildings in aerial  
48 915 images. *Computer Vision, Graphics, and Image Processing* 49 (2) : 242–277.  
49  
50 916  
51  
52 917 Monod, H., Naud, C., Makowski, D., 2006. Working with Dynamic Crop Models - Chapter 3  
53  
54  
55  
56  
57  
58  
59  
60  
61  
62  
63  
64  
65

1 918 Uncertainty and sensitivity analysis for crop models. Edited by Daniel Wallach, David  
2 919 Makowski and James W. Jones, Elsevier B.V.  
3 920  
4  
5 921 Nagao, M., Matsuyama, T., Ikeda, Y., 1979. Region extraction and shape analysis in aerial  
6  
7 922 photographs. *Computer Graphics and Image Processing*, 10(3):195–223.  
8  
9 923  
10  
11 924 Norman, J., Welles, J., 1983. Radiative transfer in an array of canopies. *Agronomy Journal*,  
12  
13 925 75(3):481–488.  
14 926  
15  
16 927 Olejnik, S., Algina, J., 2003. Generalized eta and omega squared statistics: measures of effect  
17  
18 928 size for some common research designs. *Psychological Methods*, 8(4):434–447.  
19  
20 929  
21  
22 930 Otsu, N., 1979. A threshold selection method from gray-level histograms. *IEEE Transactions*  
23  
24 931 *on Systems, Man and Cybernetics*, 9(1):62–66.  
25 932  
26  
27 933 Pierrot-Deseilligny, M., Paparoditis, N., 2006. A multiresolution and optimization-based  
28  
29 934 image matching approach: An application to surface reconstruction from SPOT5-HRS stereo  
30  
31 935 imagery. *International Archives of the Photogrammetry, Remote Sensing and Spatial*  
32  
33 936 *Information Sciences* 36 (1/W41).  
34 937  
35  
36 938 Puissant, A., Weber, C., 2014. Les images à très haute résolution spatiale: une source  
37  
38 939 d'information géographique en milieu urbain ? état des lieux et perspectives. *L'Espace*  
39  
40 940 *Géographique*, 4:345–356.  
41  
42 941  
43  
44 942 Rese ATCOR-4 User Guide, Version 7.0.3, March 2016, [http:](http://www.rese.ch/pdf/atcor4_manual.pdf)  
45 943 [www.rese.ch/pdf/atcor4\\_manual.pdf](http://www.rese.ch/pdf/atcor4_manual.pdf)  
46  
47 944  
48  
49 945 Richter, R., Schläpfer, D., 2002. Geo-atmospheric processing of airborne imaging  
50  
51 946 spectrometry data. part 2: Atmospheric/topographic correction. *International Journal of*  
52  
53 947 *Remote Sensing*, 23(13):2631–2649.  
54  
55 948  
56  
57 949 Roessner, S., Segl, K., Heiden, U., Kaufmann, H., 2001. Automated differentiation of urban  
58  
59 950 surfaces based on airborne hyperspectral imagery. *Geoscience and Remote Sensing, IEEE*  
60 951 *Transactions on*, 39(7) : 1525-1532.  
61  
62  
63  
64  
65



952

1  
2 953 Rosenbaum, D., Leitloff, J., Kurz, F., Meynberg, O., Reize, T., 2010. Real-time image  
3 954 processing for road traffic data extraction from aerial images. volume Proceedings of ISPRS  
4  
5 955 Technical Commission VII Symposium, XXXVII (7B), pages 469–474, Vienna, Austria.  
6

7 956

8  
9 957 Roskopf, E., Morhart, C., Nahm, M., 2017. Modelling Shadow Using 3D Tree Models in  
10  
11 958 High Spatial and Temporal Resolution. *Remote Sensing*, 9(7): 719.  
12

13 959

14 960 Rouse, J., 1974. Monitoring the vernal advancement and retrogradation (green wave effect) of  
15  
16 961 natural vegetation. Technical report, Progress Report RSC 1978-2 for NASA, Greenbelt, USA.  
17

18 962

19  
20 963 Sampson, D.A., Smith, F.W., 1993. Influence of canopy architecture on light penetration in  
21  
22 964 lodgepole pine (*Pinus contorta* var. *latifolia*) forests. In *Agricultural and Forest Meteorology*,  
23  
24 965 64(1–2): 63–79.  
25

26 966

27 967 Schläpfer, D., Bojinski, S., Schaepman, M., Richter, R., 2000. Combination of geometric and  
28  
29 968 atmospheric correction for AVIRIS data in rugged terrain. AVIRIS Workshop, Pasadena CA.  
30

31 969

32  
33 970 Schläpfer, D., Richter, R., Damm, A., 2013. Correction Of Shadowing In Imaging  
34  
35 971 Spectroscopy Data By Quantification Of The Proportion Of Diffuse Illumination. Presented at  
36  
37 972 the 8th SIG-IS EARSeL Imaging Spectroscopy Workshop, Nantes, pp. 10.  
38

39 973

40 974 Schläpfer, D., Richter R., Feingersh, T., 2015. Operational BRDF Effects Correction for  
41  
42 975 Wide-Field-of-View Optical Scanners (BREFCOR). *IEEE Transactions on Geoscience and*  
43  
44 976 *Remote Sensing*, vol. 53(4): 1855–1864.  
45

46 977

47 978 Shahtahmassebi, A., Yang, N., Wang, K., Moore, N., Shen, Z., 2013. Review of Shadow  
48  
49 979 Detection and De-Shadowing Methods in Remote Sensing. *Chinese Geographical Science* 23  
50  
51 980 (4): 403–420.  
52

53 981

54  
55 982 Small C., 2001. Spectral dimensionality and scale of urban radiance. Presented at 2001 AVIRIS  
56  
57 983 Workshop, Pasadena, CA, USA.  
58

59 984

60

61

62

63

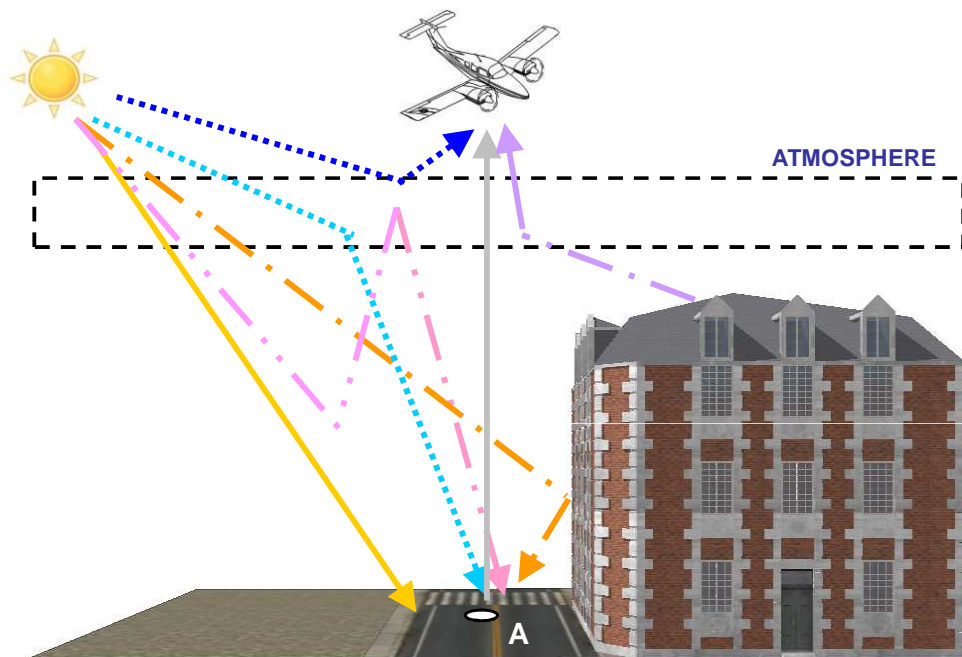
64

65

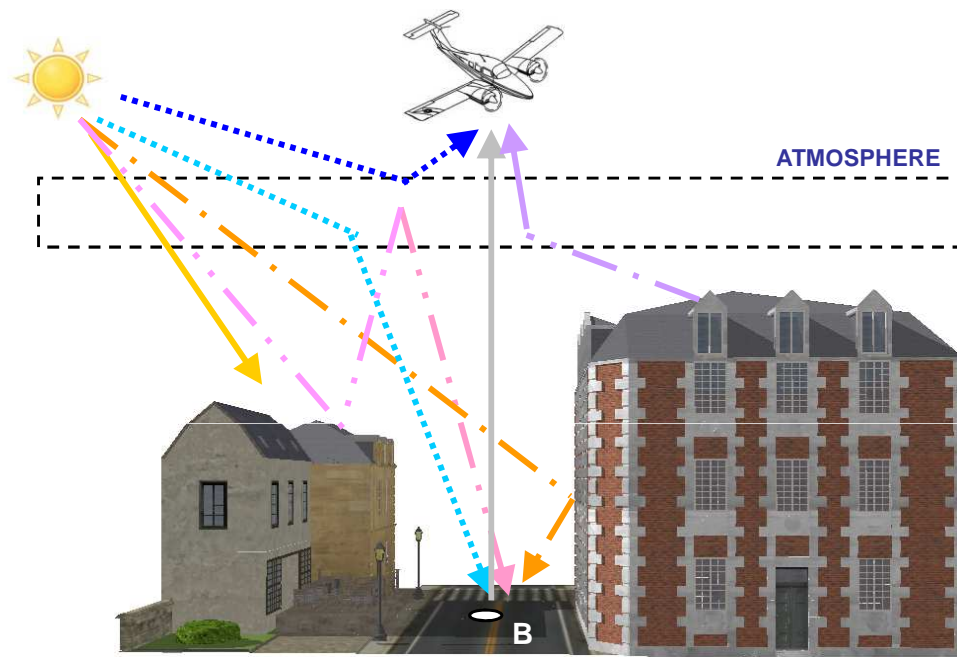
985 Vermote, E.F., Tanré, D., Deuzé, J.L., Herman, M., Morcrette, J.-J., 1997. Second Simulation  
1 986 of the Satellite Signal in the Solar Spectrum, 6S: An Overview, IEEE Transactions on  
2  
3 987 Geoscience and Remote Sensing, 35(3): 675-686.  
4  
5 988  
6  
7 989 Weiss, M., Baret, F., Myneni, R. B., Pragnère, A., Knyazikhin, Y., 2000. Investigation of a  
8  
9 990 model inversion technique to estimate canopy biophysical variables from spectral and  
10  
11 991 directional reflectance data. *Agronomie*, 20(1):3–22.  
12  
13 992  
14 993  
15 994  
16 995  
17  
18 996  
19  
20 997 Yuan, F., Bauer, M.E., 2006. Mapping impervious surface area using high resolution imagery:  
21  
22 998 A comparison of object-based and per pixel classification. In American Society for  
23  
24 999  
25  
26  
27 1000  
28  
29 1001  
30  
31 1002  
32  
33  
34  
35  
36  
37  
38  
39  
40  
41  
42  
43  
44  
45  
46  
47  
48  
49  
50  
51  
52  
53  
54  
55  
56  
57  
58  
59  
60  
61  
62  
63  
64  
65

Figure1  
[Click here to download Figure: Fig1.pdf](#)

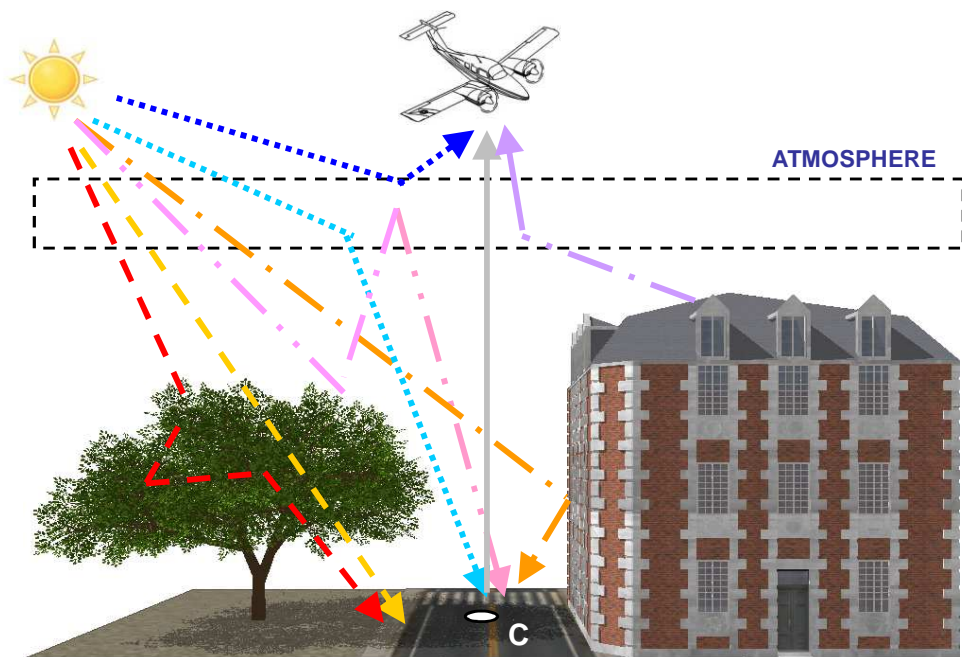
a) IC



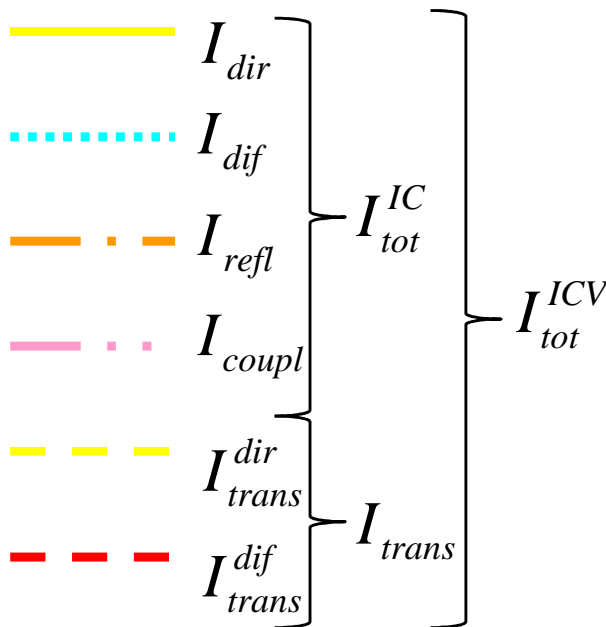
b) IC



c) ICV



**IRRADIANCES**



**RADIANCES**

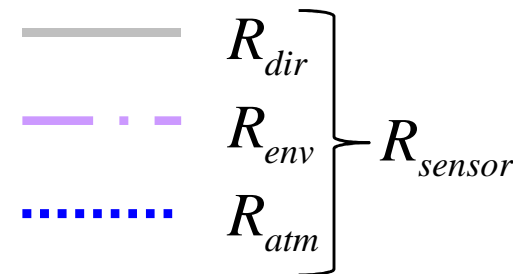


Figure3

[Click here to download Figure: Fig3.pdf](#)

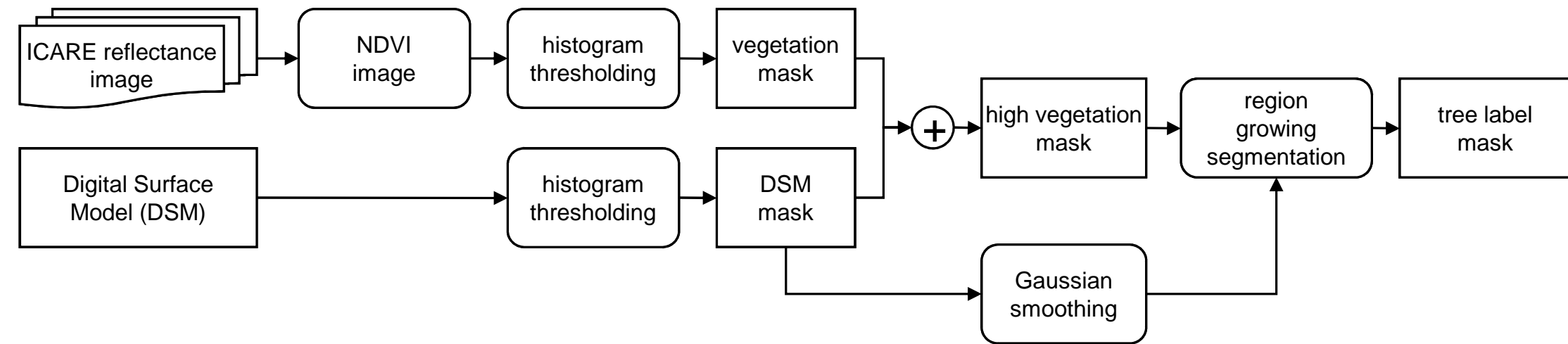
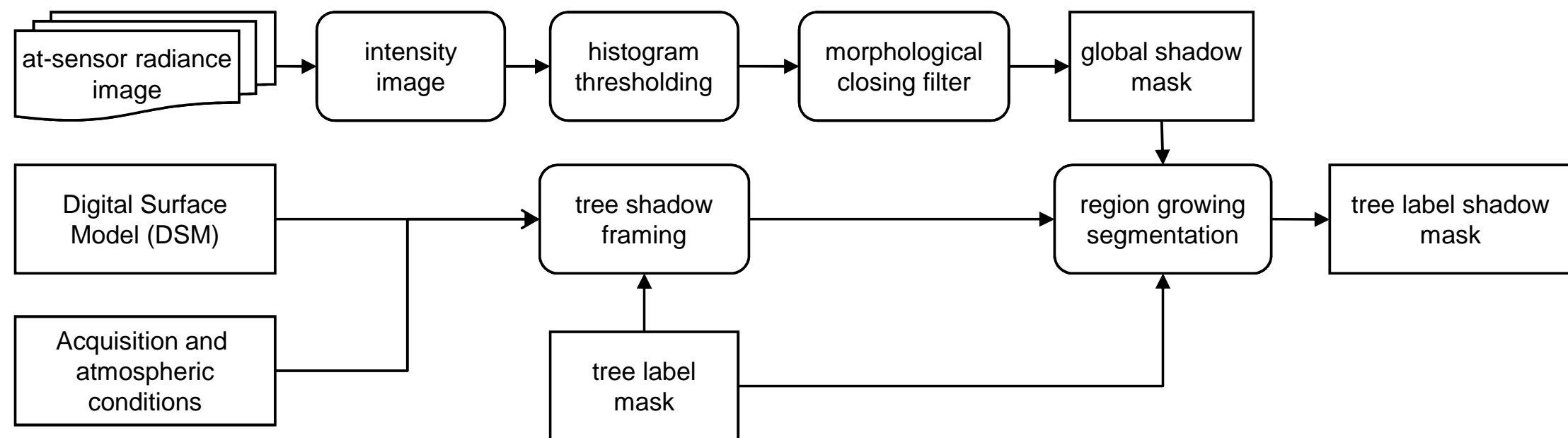
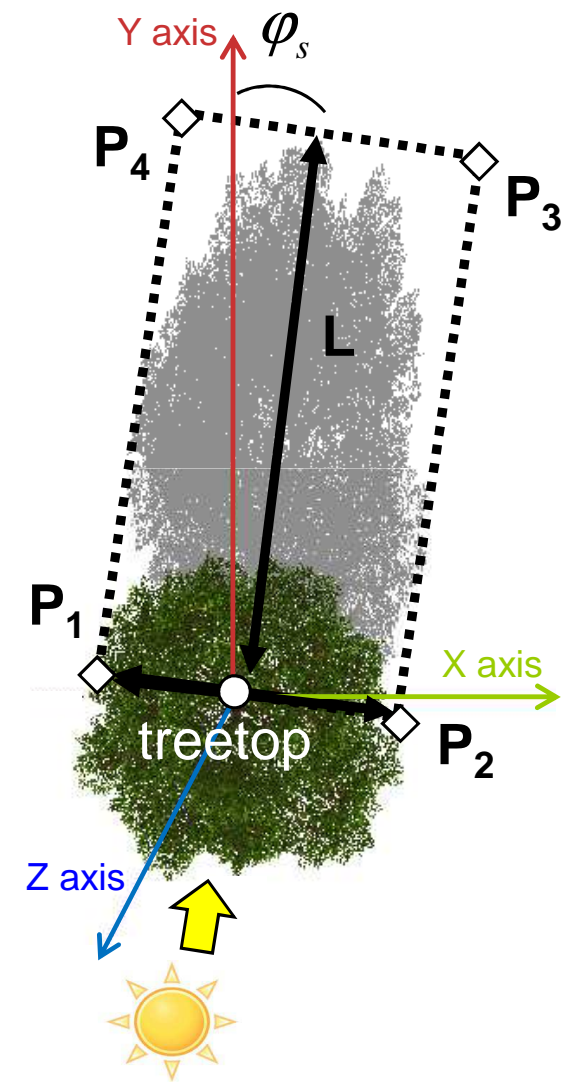


Figure4

[Click here to download Figure: Fig4.pdf](#)



a) upper view



b) 3D view

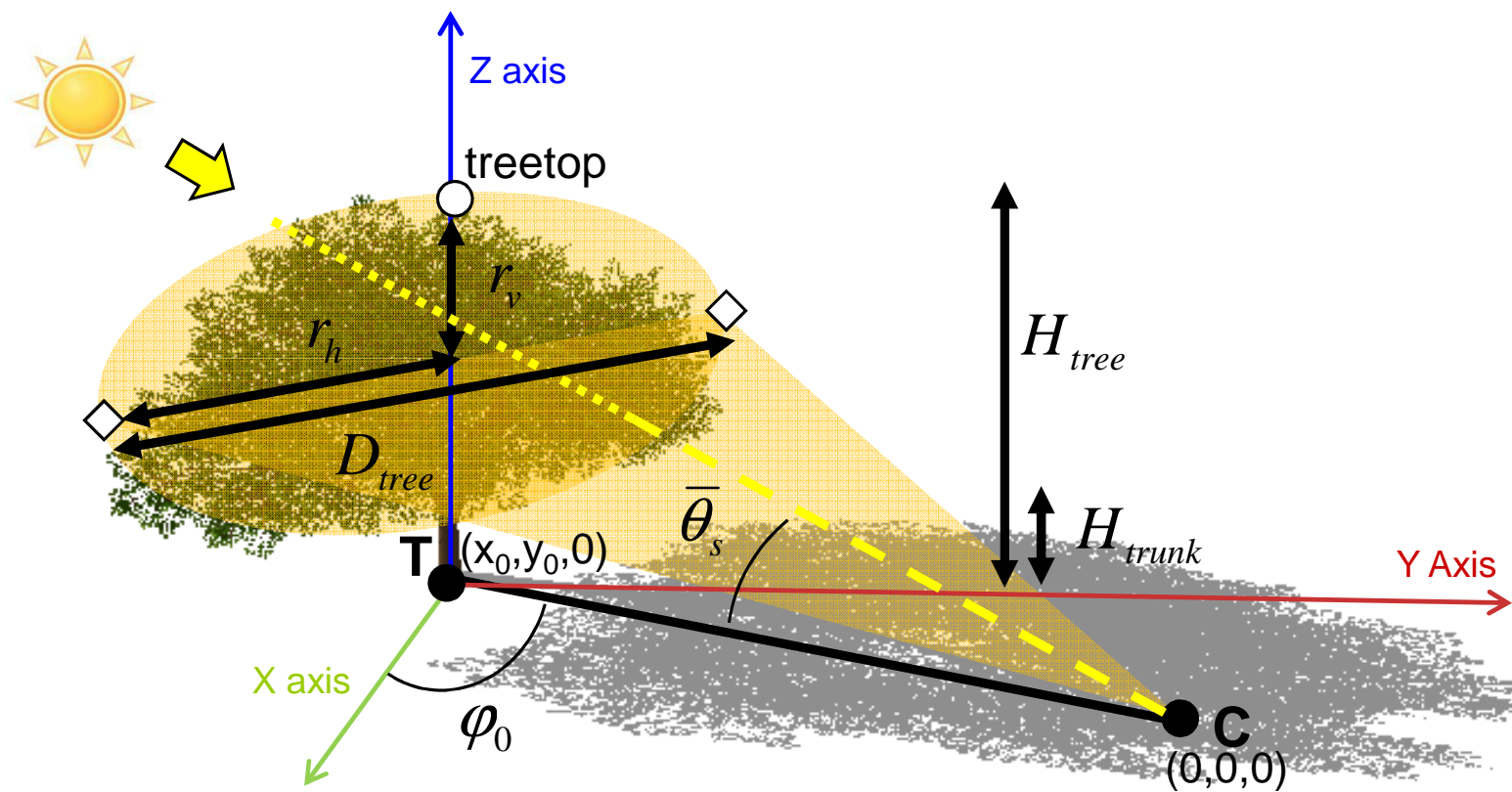
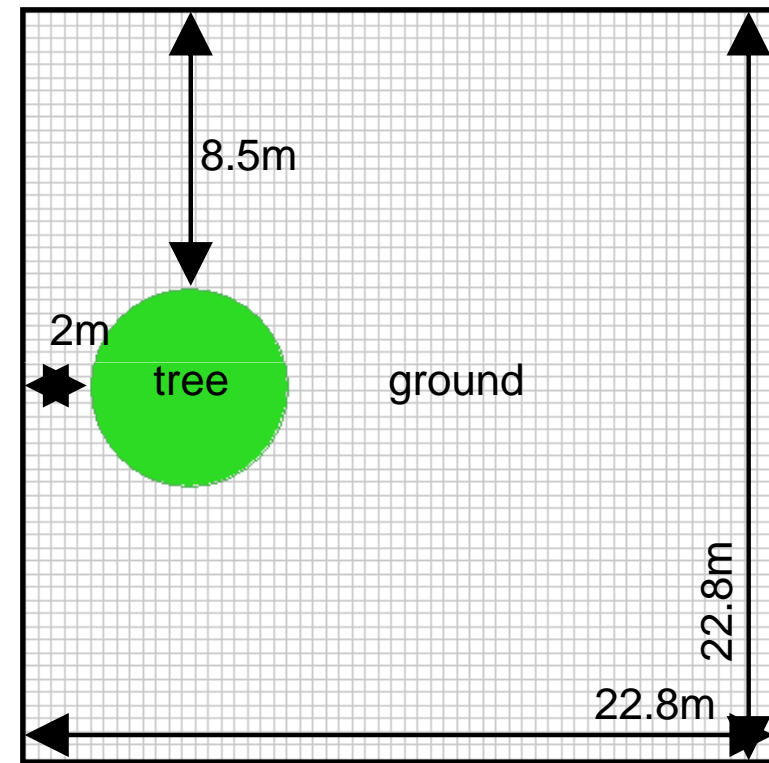


Figure6

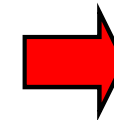
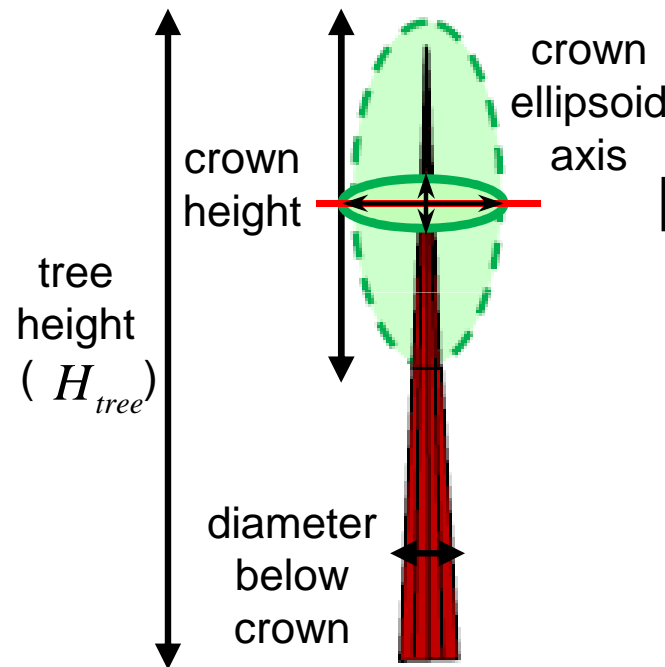
[Click here to download Figure: Fig6.pdf](#)

### Mock-up modeling (top view)



$$\theta_s = [30^\circ, 45^\circ]$$

### Tree modeling



### 2D profile of the tree crown (turbid voxel representation)

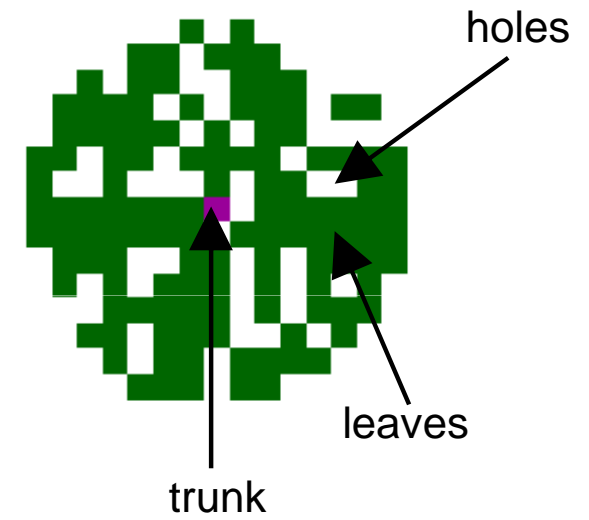
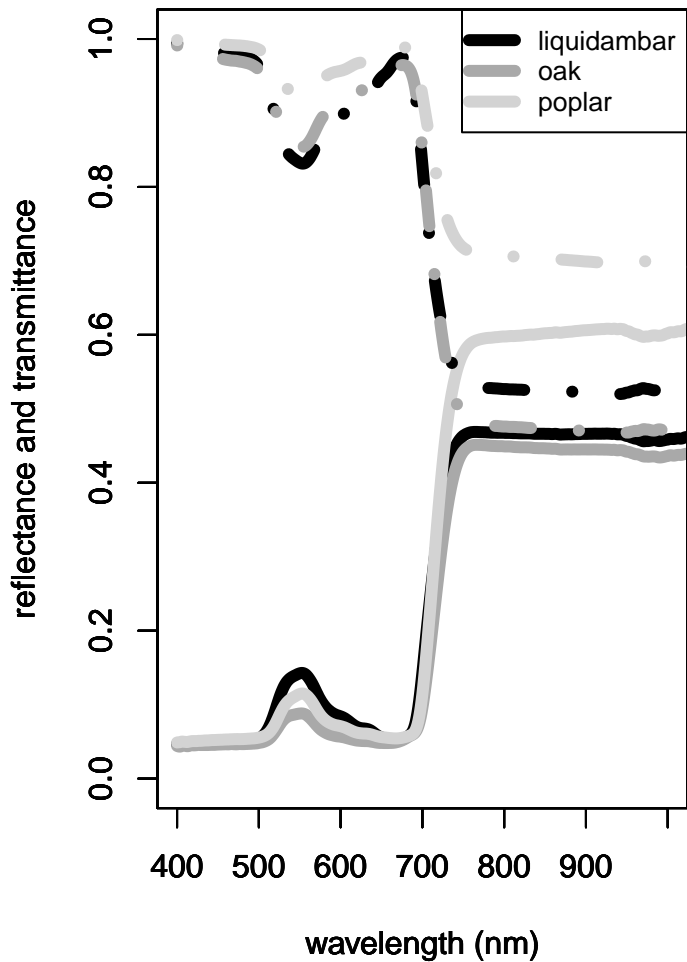
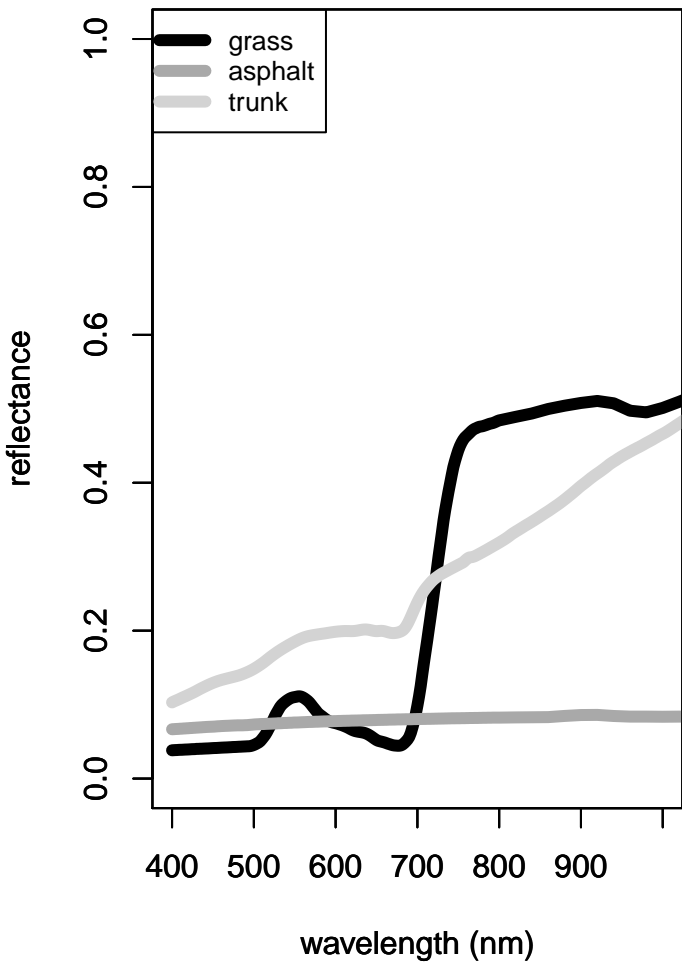


Figure7

[Click here to download Figure: Fig7.pdf](#)





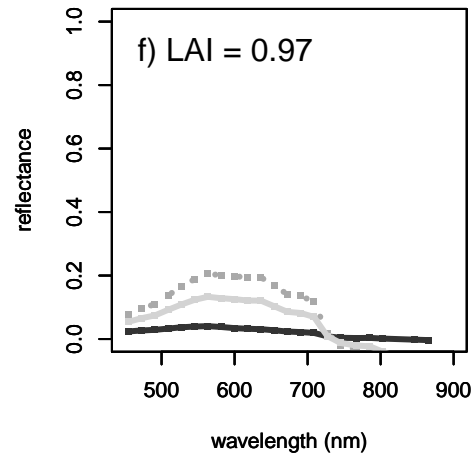
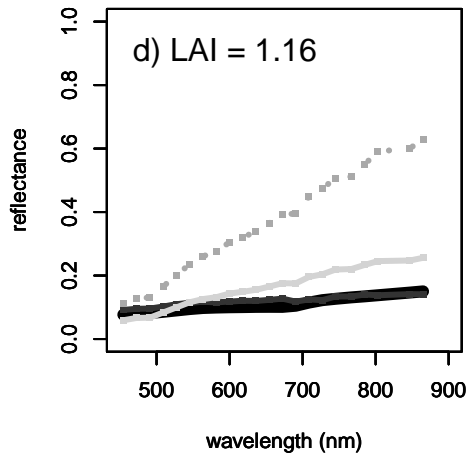
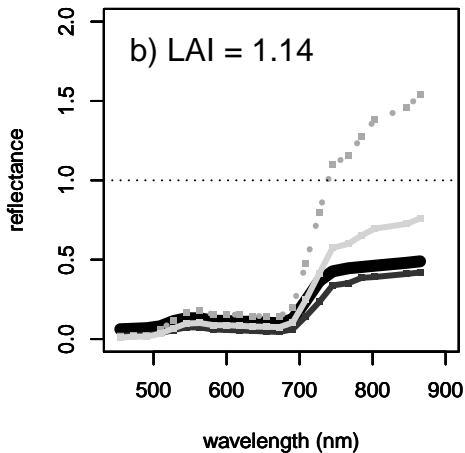
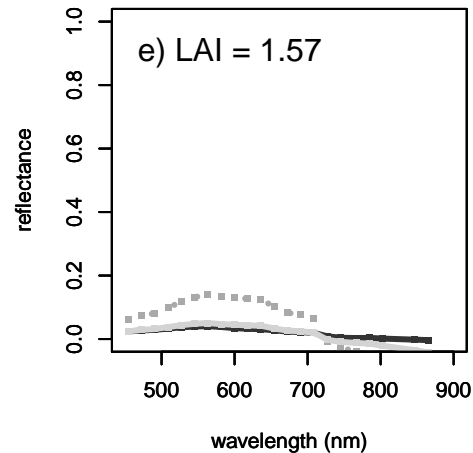
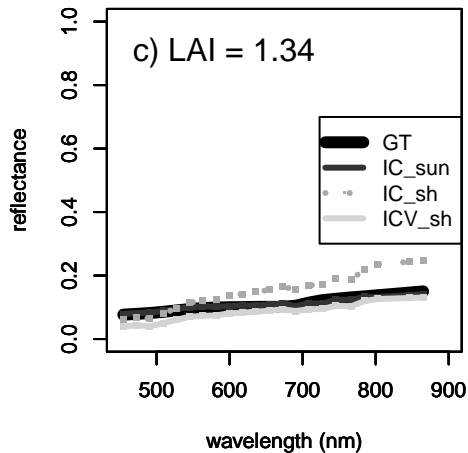
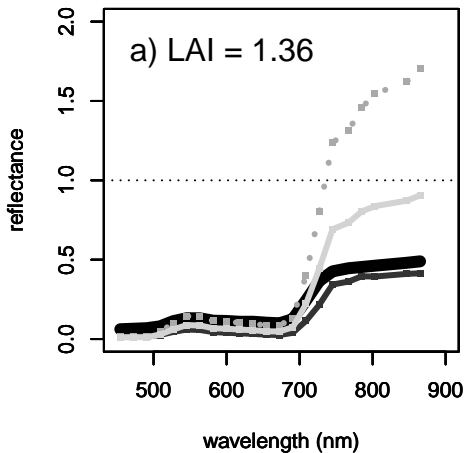
**Figure13**

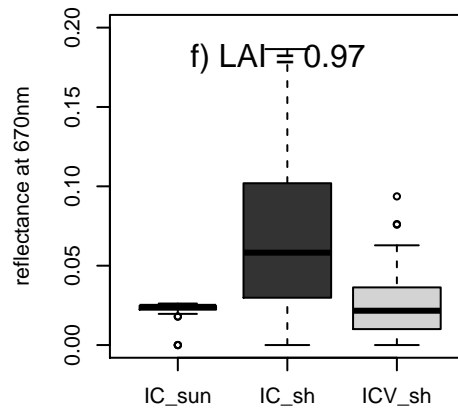
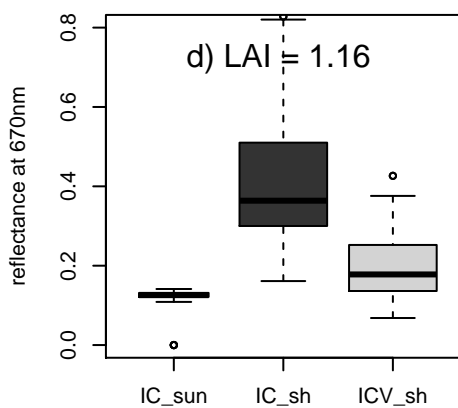
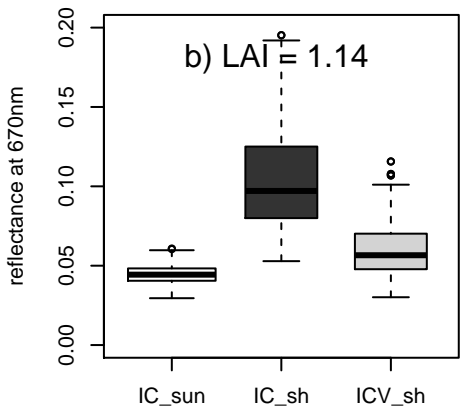
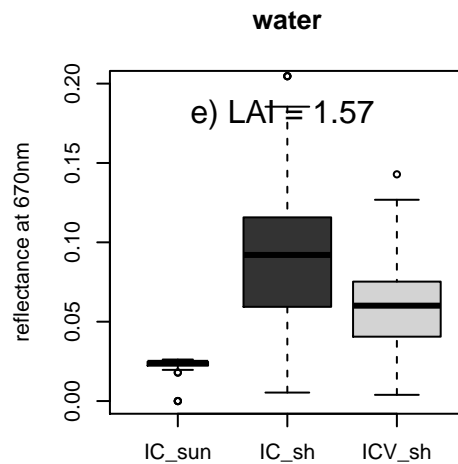
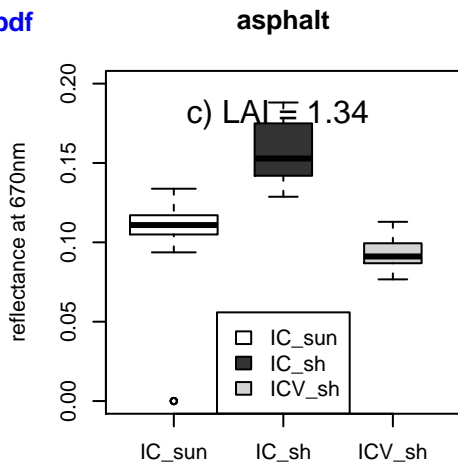
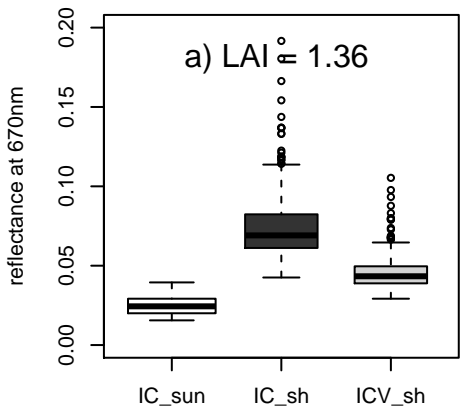
[Click here to download Figure: Fig13.pdf](#)

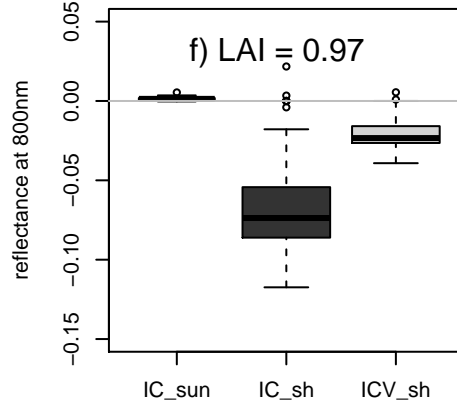
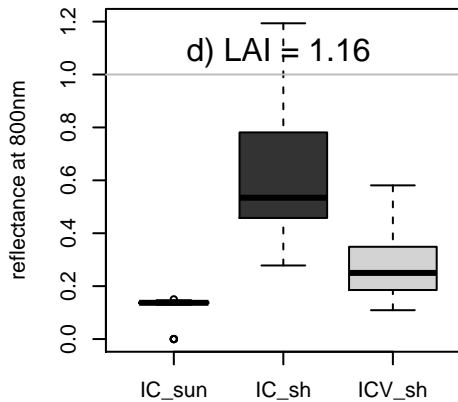
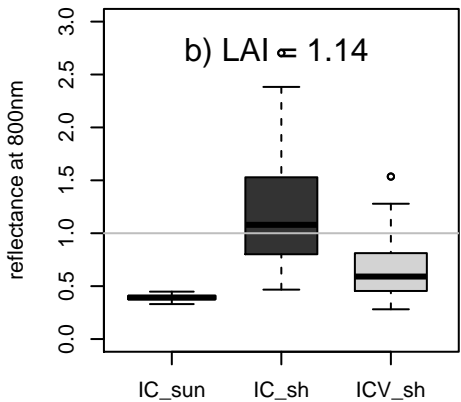
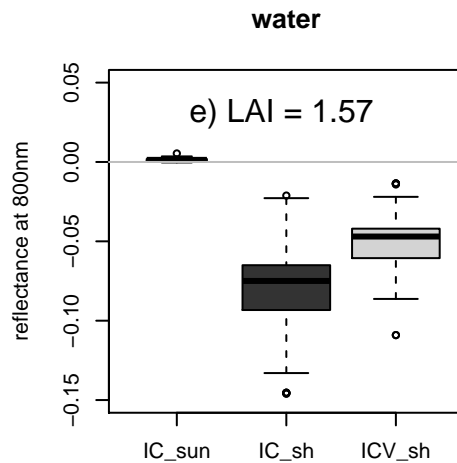
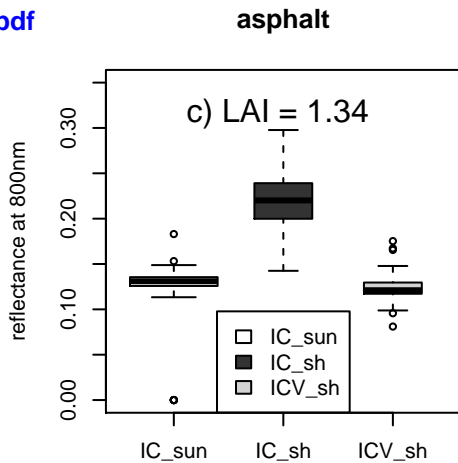
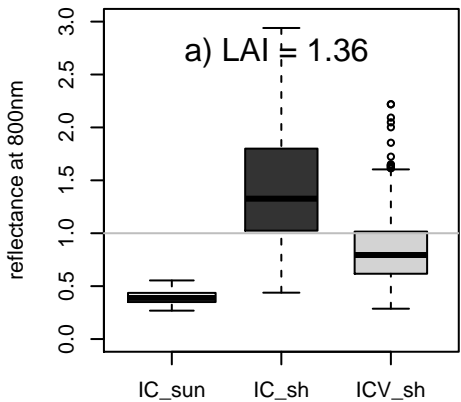
grass

asphalt

water

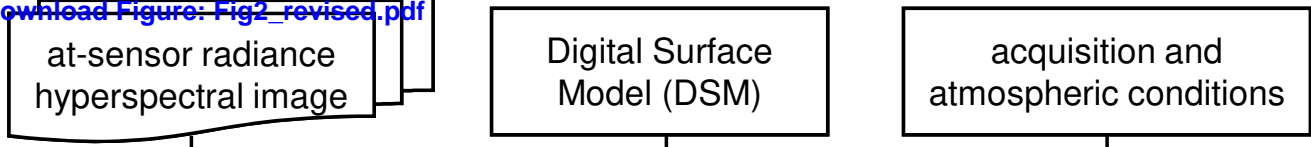


**Figure14a**[Click here to download Figure: Fig14a.pdf](#)

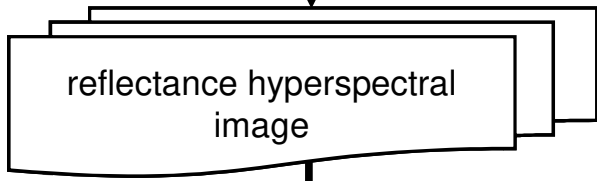
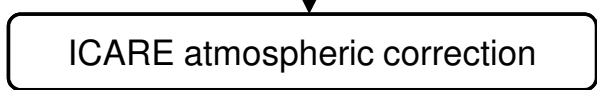
**Figure14b**[Click here to download Figure: Fig14b.pdf](#)

Figure

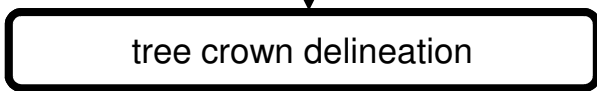
[Click here to download Figure: Fig2\\_revised.pdf](#)



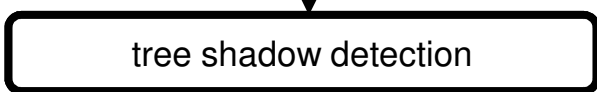
3.1



3.2

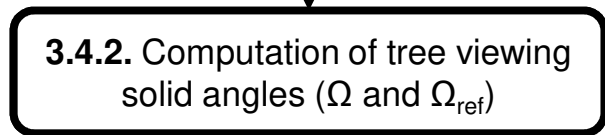
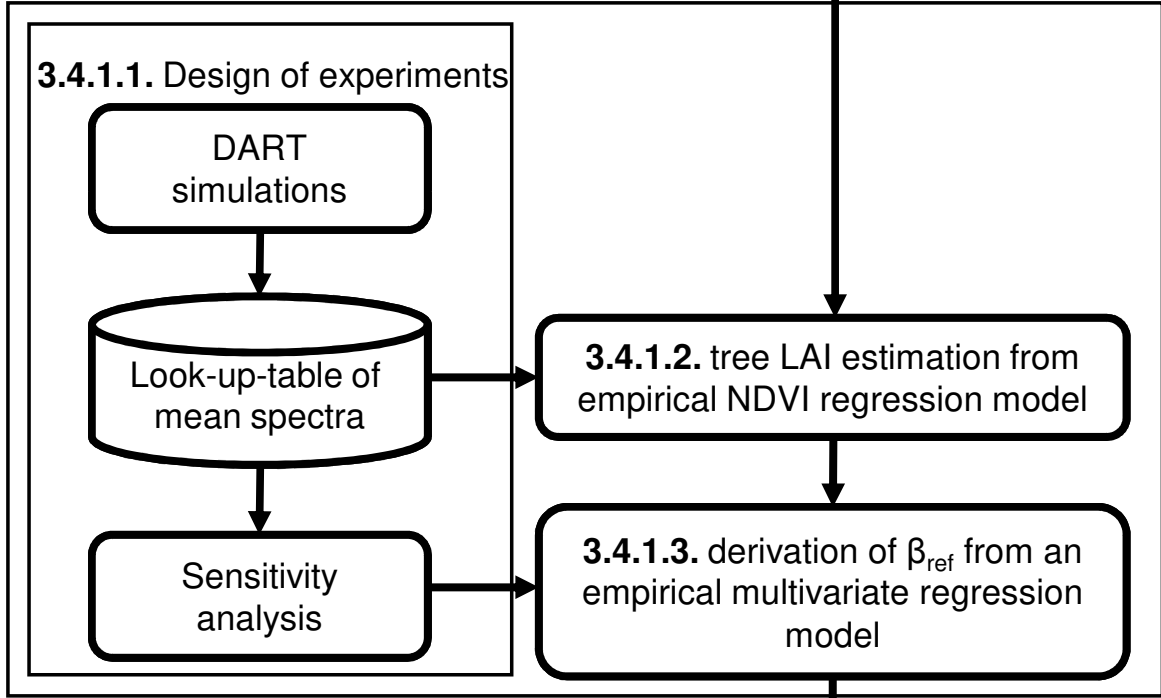


3.3



3.4

3.4.1. Reference correction factor ( $\beta_{ref}$ )



3.5

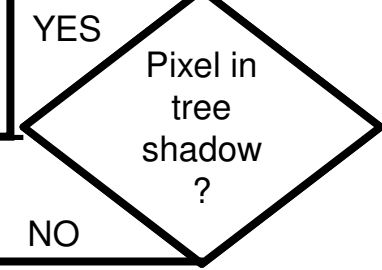
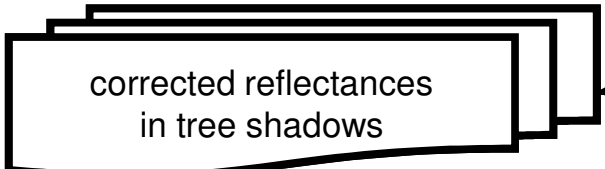
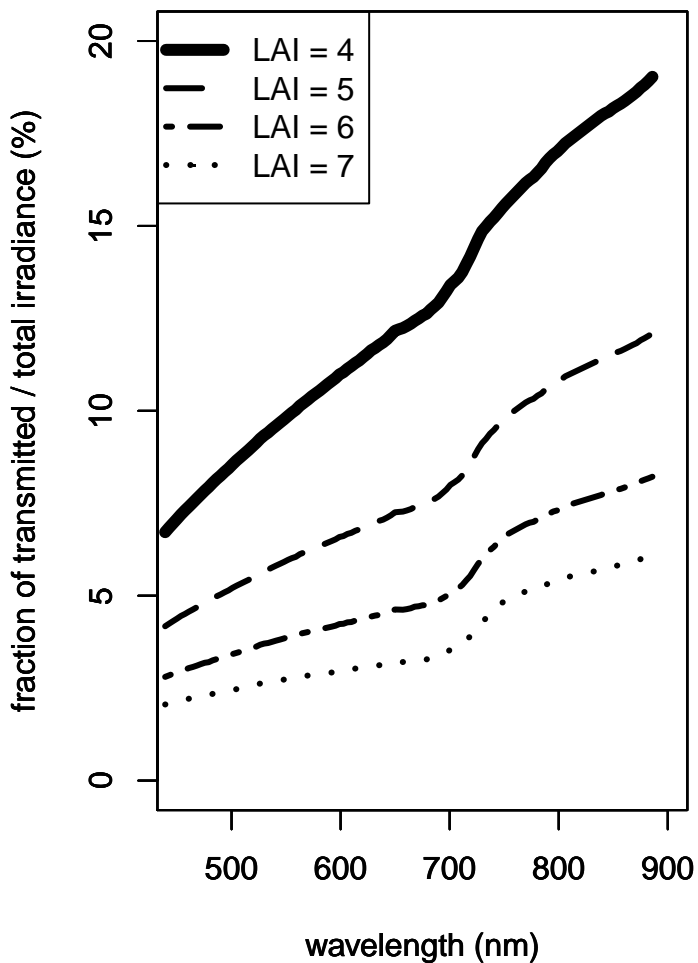
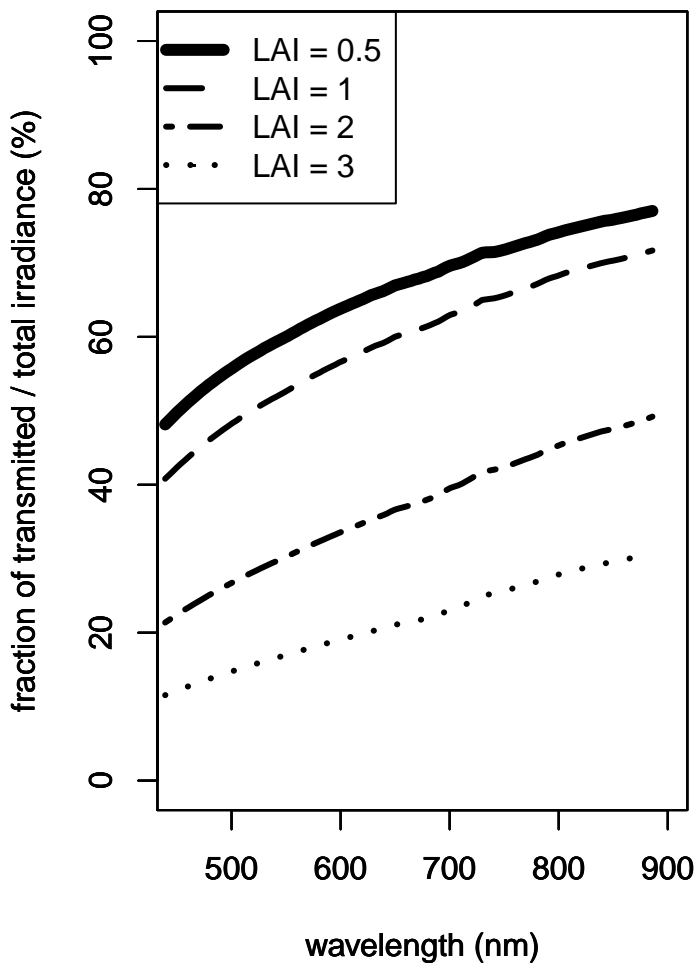
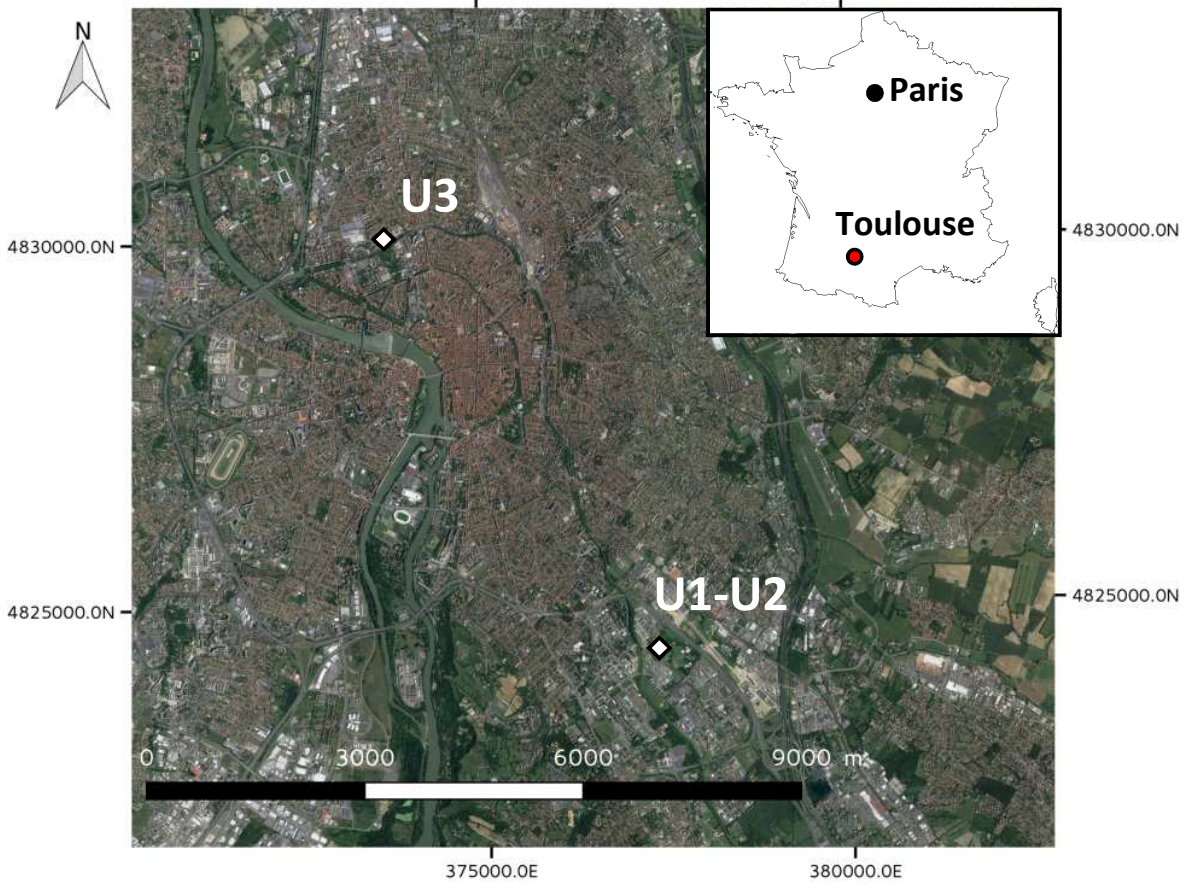
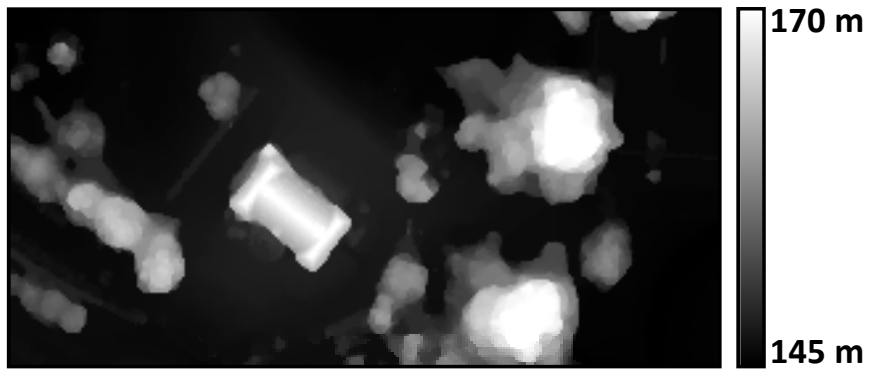


Figure  
[Click here to download Figure: Fig8\\_revisednumber.pdf](#)

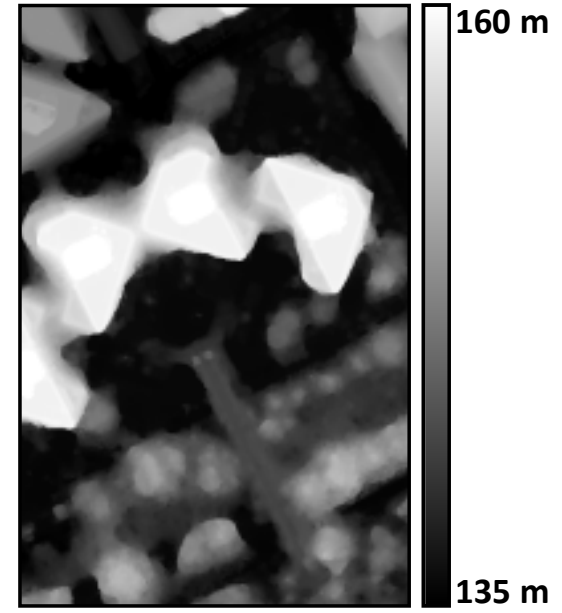




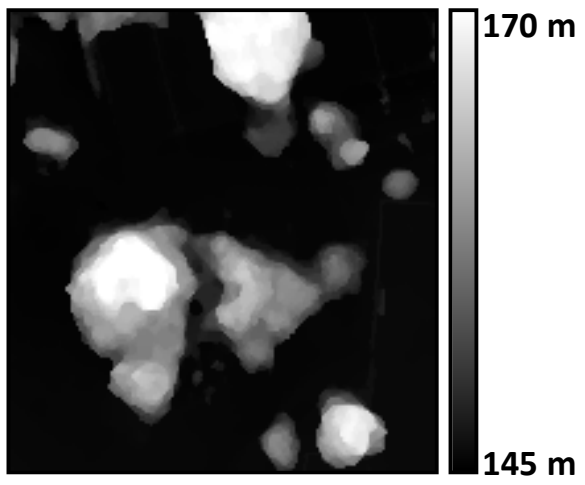
**U2 – 2.3 km<sup>2</sup>**



**U3 – 2.1 km<sup>2</sup>**

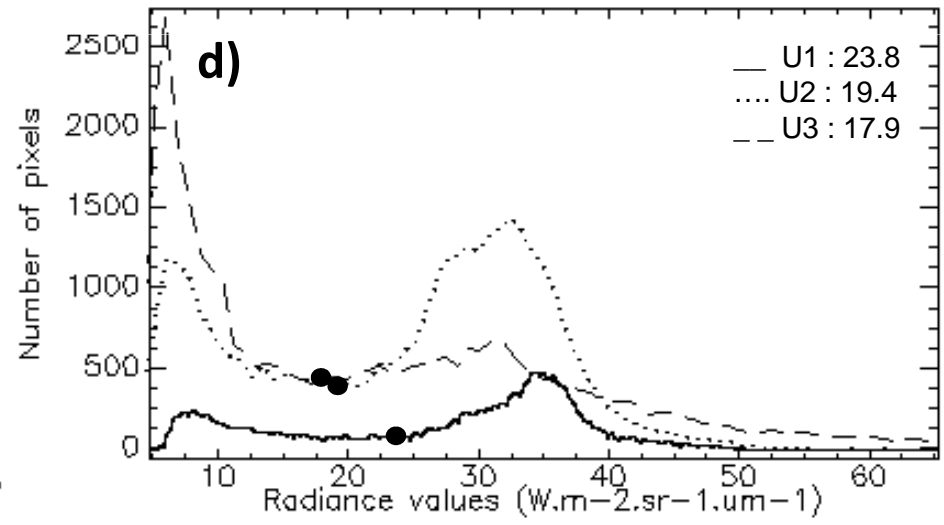
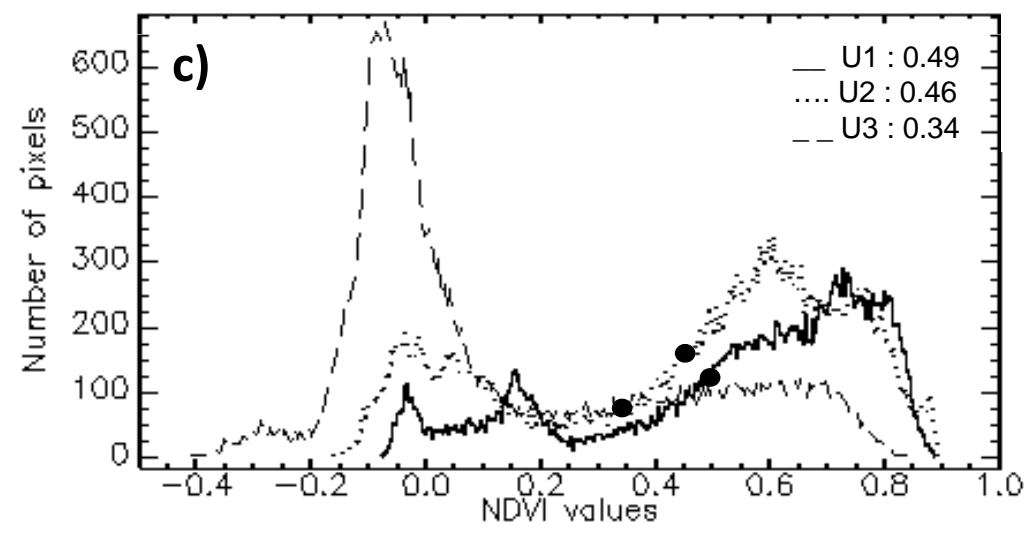
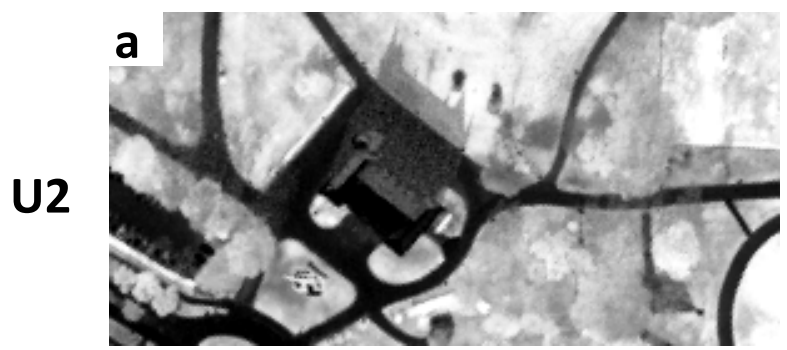
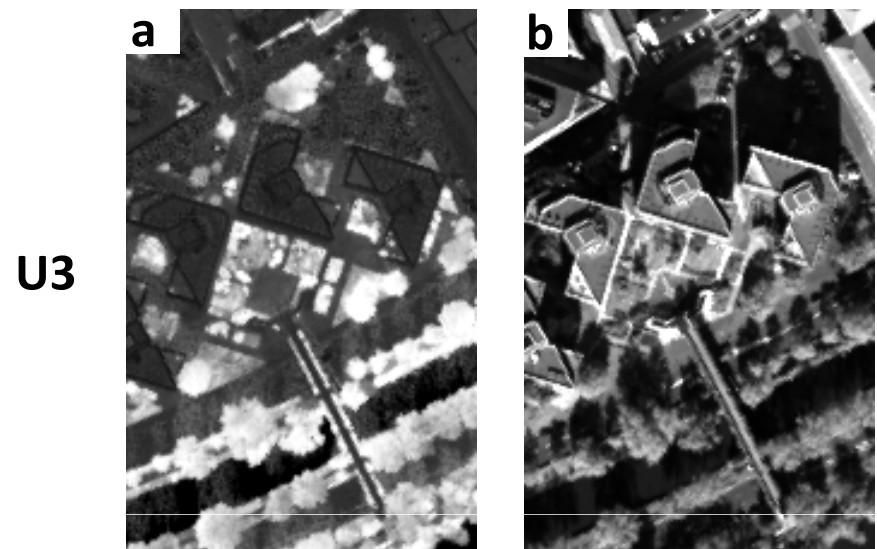
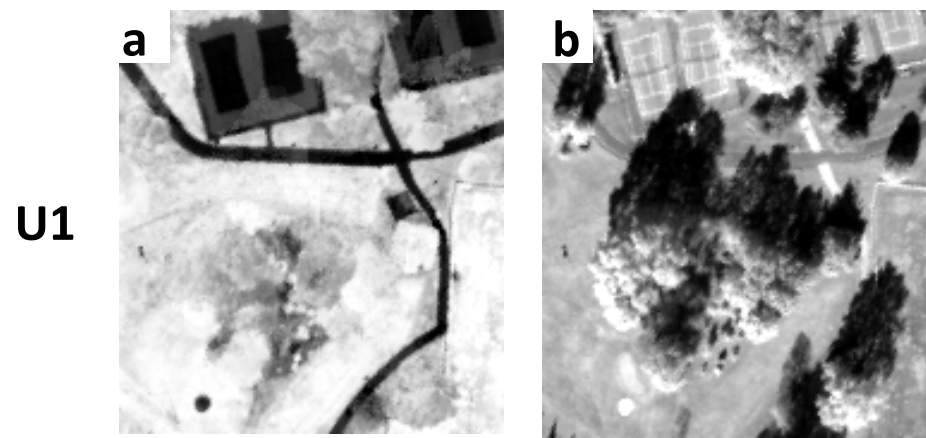


**U1 – 1.8 km<sup>2</sup>**

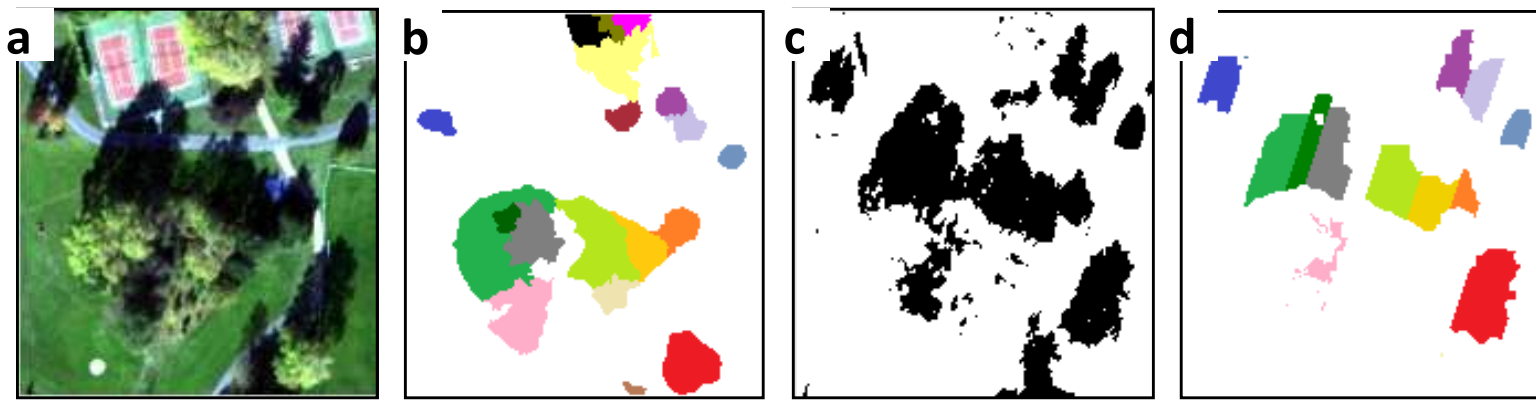


Figure

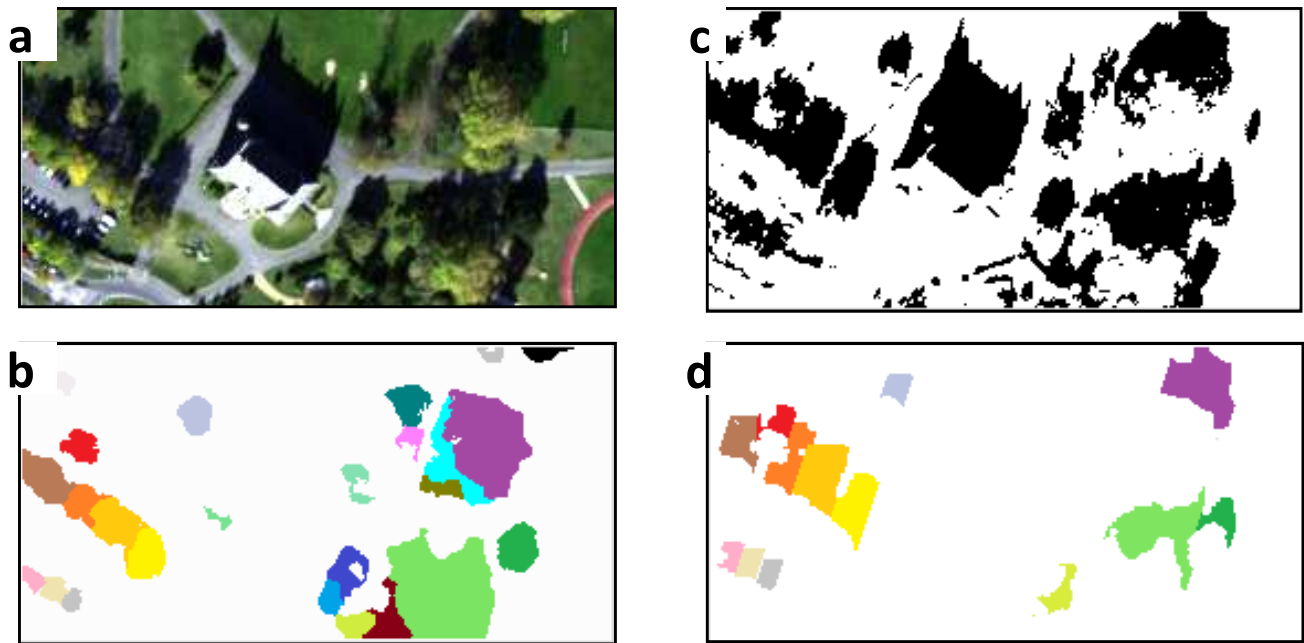
[Click here to download Figure: Fig10\\_revisednumber.pdf](#)



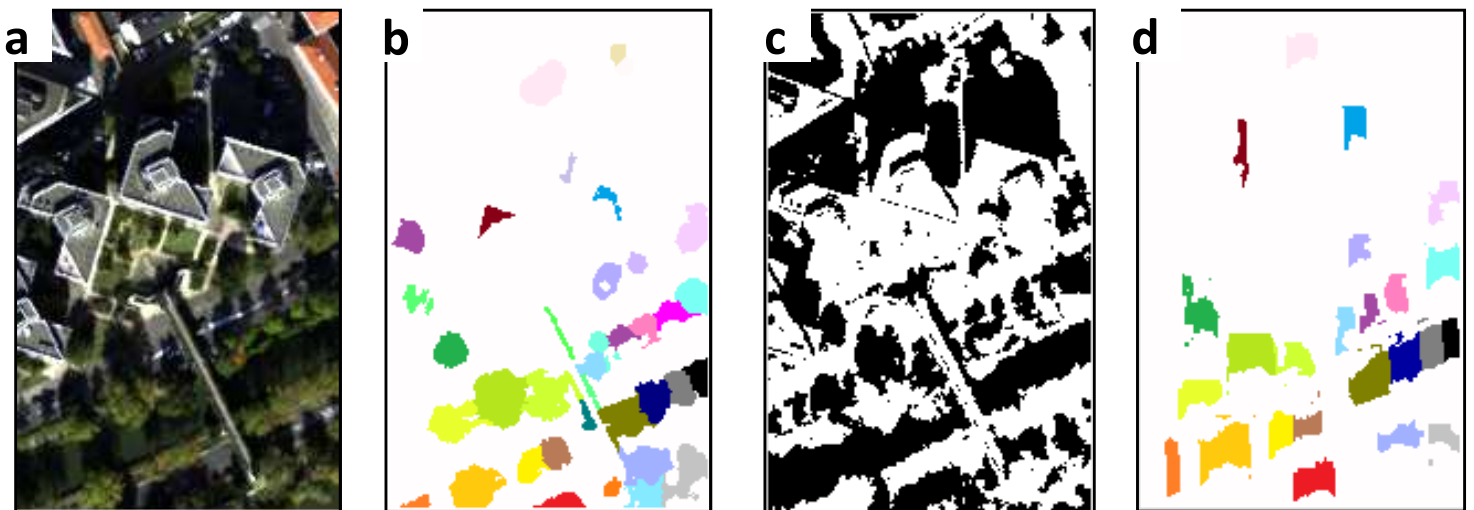
### U1



### U2

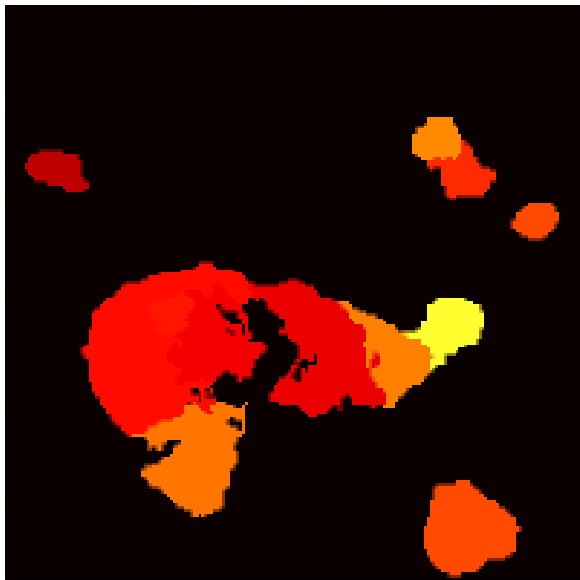


### U3

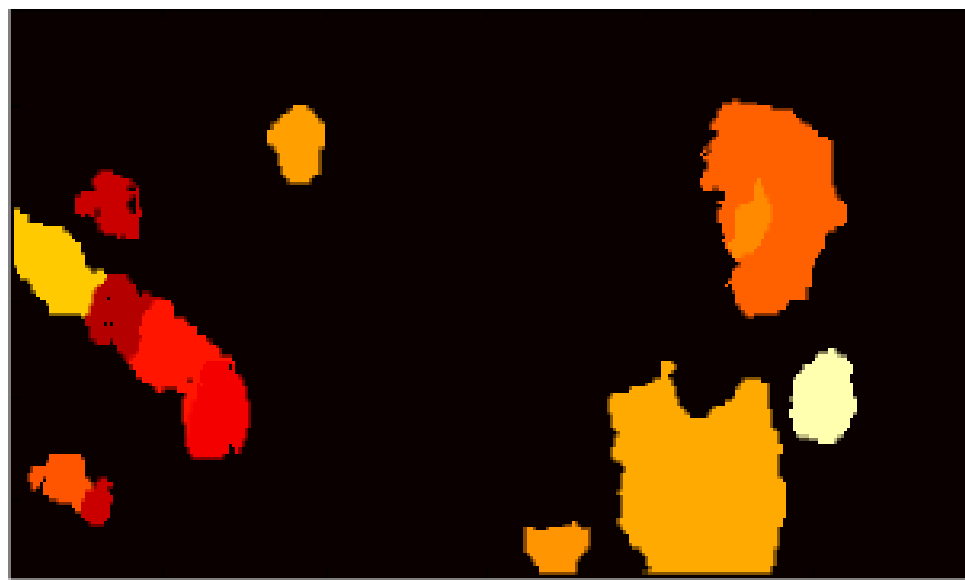




U1



U2



U3

