



HAL
open science

Frictionless contact of elastic bodies by finite element method and mathematical programming technique

Nguyen Dang Hung, Géry De Saxcé

► To cite this version:

Nguyen Dang Hung, Géry De Saxcé. Frictionless contact of elastic bodies by finite element method and mathematical programming technique. *Computers & Structures*, 1980, 11 (1-2), pp.55-67. <10.1016/0045-7949(80)90146-7>. <hal-01828018>

HAL Id: hal-01828018

<https://hal.science/hal-01828018v1>

Submitted on 20 Sep 2018

HAL is a multi-disciplinary open access archive for the deposit and dissemination of scientific research documents, whether they are published or not. The documents may come from teaching and research institutions in France or abroad, or from public or private research centers.

L'archive ouverte pluridisciplinaire HAL, est destinée au dépôt et à la diffusion de documents scientifiques de niveau recherche, publiés ou non, émanant des établissements d'enseignement et de recherche français ou étrangers, des laboratoires publics ou privés.



HAL Authorization

FRICTIONLESS CONTACT OF ELASTIC BODIES BY FINITE ELEMENT METHOD AND MATHEMATICAL PROGRAMMING TECHNIQUE

NGUYEN DANG HUNG† and GÉRY de SAXCÉ‡

Department of Structural Mechanics and Stability of Constructions, University of Liège, Belgium

(Received 13 June 1979)

Abstract—The work presents an analysis of the contact problems between elastic bodies without friction. Extended variational principles in the contact problems constitute the theoretical foundations of the analysis. In fact, kinematically admissible displacement fields are subjected to the non-interpenetration conditions so that the contact problem being equivalent to a minimization of the potential energy with constraints on the displacements may be reduced to a particular case of the mathematical programming techniques. Applications are limited to plane state of stress or strain cases where small deformations are considered. The geometrical space is discretized into finite elements, namely the 12 degree of freedom hybrid triangles or the 16 degrees of freedom isoparametric bi-linear quadrangle elements. A special procedure of linearization is adopted to use the quadratic programming algorithm already prepared for large scale problems.

In these conditions, a computer program has been written in FORTRAN IV H and the results obtained from this present good agreement comparing to analytical solutions or other numerical solution in the literature. Finally, theoretical efforts have been performed to generalize the method by introducing a concept of fictitious locked material which represents the assumed contact space between the two bodies.

A general and new condition of non-interpenetration is proposed for general cases of two elastic solids in contact.

NOMENCLATURE

x_i	Lagrangian coordinates
ξ_i	Eulerian coordinates
V, V_A, V_B	geometric domains of elastic bodies
$\Gamma_\sigma, \Gamma_{\sigma_A}, \Gamma_{\sigma_B}$	portion of boundary of V, V_A, V_B where \bar{t}_i are prescribed
\bar{n}, η_i	normal vector defined on the boundaries
Ω	rigid domain
$\partial\Omega$	boundary of Ω
$\varepsilon_{ij}, \varepsilon$	strain tensor, strain field
$U(\varepsilon_{ij})$	density of the strain energy
σ_{ij}, σ	stress tensor, stress field
τ_{ij}	stress tensor (Piola) (Euler-cauchy)
f_i	body forces
\bar{t}_i	tractions prescribed on the boundaries
q	nodal displacement vector
g	nodal generalized force vector
K	global stiffness matrix
Φ	total potential strain energy
Φ^*	modified total potential energy
Φ_c	contact potential
ϕ_c	dislocation potential
Π	contact constraint function
λ	Lagrange's parameter
ω	slack variable
A	constraint matrix
D_i, ∇	Lagrangian gradient operator
α_{ij}	displacement gradient
$[J_{ij}]$	Jacobian matrix
J	Jacobian, determinant of $[J_{ij}]$
I_{ij}	minor of element J_{ij} in $[J_{ij}]$

1. INTRODUCTION

The problem of contact of elastic bodies even in small deformations is a nonlinear problem because of the complicating factor: the presence of the unknown surface contact. One may find in the literature two distinct ways of numerical approach for this problem; the iterative method; and the direct method.

The first method consists of calculating the increment of loading and verifying the contact condition at each step. Following authors may be cited among the adepts of this procedure. Chan and Tuba [1], Gaertner [2], Zienkiewicz and Franca-villa [3], Fredriksson [4].

The second method consists of reducing the elastic contact problem to a special case of the mathematical programming techniques. By that way, Feng and Huang [5] have examined the contact problem of an inflated plane membrane. The variational forms of the contact problem is studied by Fremond [6] who has presented some numerical examples of contact between elastic bodies and rigid foundation. Panagiotopoulos [7] has generalized this approach to the inelastic foundation and presented some dual forms of the variational inequalities for the contact problem.

The present work belongs to the second type of formulation where appropriate linearization of contact condition is adopted. It is assumed that no friction between solid bodies exists so that the contact condition may be expressed uniquely in terms of displacements. It is supposed also that the deformation is small and the material obeys the linear elastic constitutive equations. In the numerical examples, we will be dealing only with plane strain or stress two dimensions problems. The generalization of the formulation to the three dimensions bodies would

†Maitre de Conférences.

‡Engineer Physician.

present no major difficulties but a considerable increasing number of variables. This paper may be divided in two sections. In the first section, the contact between an elastic body and a rigid foundation is considered.

Good agreement numerical results obtained using the present finite element algorithm adopting this formulation and the super-element technique are illustrated.

In the second section, theoretical efforts are performed to generalize the formulation. We introduce a concept of representing the space separating the contacting surface as a fictitious perfectly locking material.

This concept is pointed out by adopting a new and general non-interpenetration condition which involves important commodity for the formulation of the contact problem of elastic bodies. It may be seen that in the particular case of rigid-elastic contact under small deformations assumption, the general non-interpenetration condition is reduced to the constraint condition of the case mentioned above.

2. CONTACT OF AN ELASTIC BODY AND A RIGID FOUNDATION

2.1 Kinematically admissible displacements in the sense of contact problem

Let Ω be the rigid foundation and $\partial\Omega$ its boundary. Let V be the elastic body. Its boundary is composed of three portions: Γ_σ where surface tractions \bar{t}_i are prescribed, Γ_u where displacements \bar{u}_i are prescribed and Γ_c where possible contact may happen (Fig. 1).

The initial configuration of the body V is determined by a position vector $OP = \mathbf{x}$. The components of which x_i are the Lagrangian coordinates of the material point. Let $\mathbf{u}(\mathbf{x})$ be the displacement vector of the point P under loading. The new position P' of P after deformation is described by the new coordinates

$$OP' = \xi = \mathbf{x} + \mathbf{u} \quad (2.1)$$

where the components of ξ , ξ_i are Eulerian coordinates of the material point P' .

We assume that the surface of the foundation $\partial\Omega$ is regular so that it may be defined by the following equation:

$$\Pi(\xi) = 0. \quad (2.2)$$

In practice, eqn (2.2) defines only the possible contacting surface but not necessarily the whole surface $\partial\Omega$. By convention, we suppose that the region where $\Pi(\xi)$ is negative belongs to the foundation Ω . The displacement field \mathbf{u} is kinematically admissible in contact problem sense if it satisfied the following non-interpenetration condition

$$\Pi(\mathbf{x} + \mathbf{u}) \geq 0. \quad (2.3)$$

2.2 Displacement variational principle

The classical total potential energy of an elastic body V subjected to imposed body forces \bar{f}_i and prescribed traction \bar{t}_i on Γ_σ is

$$\Phi(u_i) = \int U(\varepsilon_{ij}) dV - \int f_i u_i dV - \int \bar{t}_i u_i d\Gamma_\sigma \quad (2.4)$$

where U is the density of strain energy.

ε_{ij} is kinematically admissible strain field such that

$$\varepsilon_{ij} = \frac{1}{2}(D_i u_j + D_j u_i). \quad (2.5)$$

The contact problem [6] is reduced to a minimization of the functional (2.4) subjected to the constraint (2.3) with respect to arbitrary kinematically admissible displacement field u_i minimized $\Phi(u_i)$.

$$u_i \in H_K$$

$$H_K = \{u_i \mid u_i = \bar{u}_i \text{ on } \Gamma_u$$

and

$$\Pi(x_i + u_i) \geq 0 \text{ on } \Gamma_c\}. \quad (2.6)$$

Now introducing a slack variable ω the inequality (2.3) may be substituted by the following equality:

$$\Pi(x_i + u_i) - \omega^2 = 0 \quad (2.7)$$

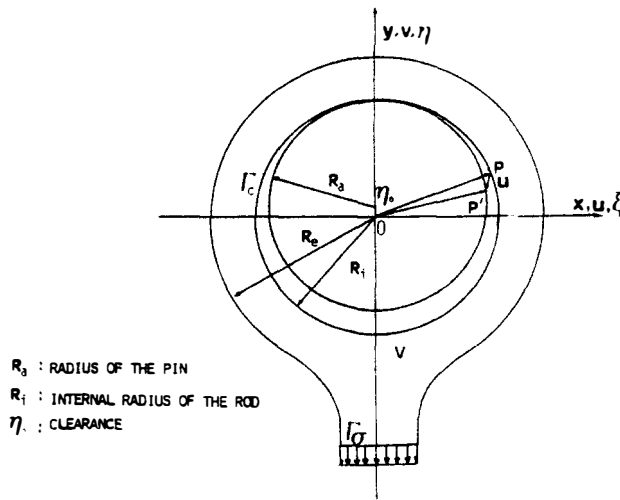

Fig. 1. Contact surface Γ_c and external surface Γ_σ contact between a pin and a piston rod

and using a Lagrange's parameter λ a relaxation of (2.7) may be performed by a dislocation potential according to Friedrich

$$\phi(u_i, \lambda, \omega) = -\int \lambda [\Pi(x_i + u_i) - \omega^2] d\Gamma_c. \quad (2.8)$$

If a modified functional Φ^* is adopted such that

$$\Phi^*(u_i, \lambda, \omega) = \Phi(u_i) + \phi(u_i, \lambda, \omega) \quad (2.9)$$

the following variational problem is equivalent to (2.6):

$$\delta\Phi^*(u_i, \lambda, \omega) = 0 \quad (2.10)$$

with $u_i, H = \{u_i | u_i = \bar{u}_i \text{ on } \Gamma_u\}$.

There are no difficulties to see that the Euler-Lagrange equations of the problem (2.10) are

$$\text{Internal equilibrium: } D_j \sigma_{ij} + \bar{f}_i = 0 \quad (2.11)$$

$$\text{Surface equilibrium on } \Gamma_\sigma: n_j \sigma_{ij} = \bar{t}_i \quad (2.12)$$

$$\text{Contact equilibrium on } \Gamma_c: n_j \sigma_{ij} = \lambda D_i \pi \quad (2.13)$$

$$\text{Displacement constraint on } \Gamma_c: \Pi(x_i + u_i) - \omega^2 = 0 \quad (2.14)$$

$$\text{Complementarity condition on } \Gamma_c: \lambda \omega = 0. \quad (2.15)$$

It appears from (2.15) that if $\omega \neq 0$, then $\lambda = 0$. There is no contact according to (2.14) and by (2.13) no contact pressure takes place. If $\omega = 0$ then $\lambda > 0$ and there is contact. So the complementarity condition (2.15) restores the Kuhn-Tucker optimality conditions. The Fig. 2 illustrates the situation discussed above. An interpretation of the Lagrange parameter λ may be performed in the following way. There is no friction so the surface tractions must be normal to the contacting surface Γ_c .

$$t = \lambda \nabla \Pi.$$

Consequently

$$\lambda = \frac{\|t\|}{\|\nabla \Pi\|}. \quad (2.16)$$

If one has chosen the normalized constraint function

$$\Pi_0 = \Pi / \|\nabla \Pi\| \quad (2.17)$$

instead of Π , then λ is identified exactly as the contact pressure.

2.3 Finite element formulation

Classical discretization using compatible finite element and displacement method leads to the following forms of total potential energy of the whole structure:

$$\Phi = \frac{1}{2} q^T K q - g^T q \quad (2.18)$$

where q is nodal displacement vector

g is generalized force vector

K is the stiffness matrix.

The finite element discretization of the contact potential

$$\Phi_c = \int \lambda \Pi(x_i + u_i) d\Gamma_c \quad (2.19)$$

may be realized in the following way.

Assuming the displacements are small. We may remain only the first order terms of the Taylor's expansion of the function $\Pi(x_i + u_i)$

$$\Pi(x_i + u_i) \simeq \Pi(x_i) + D_k \Pi(x_i) u_k + 0(u_i u_k).$$

So that inequality (2.3) becomes

$$D_k \Pi(x_i) u_k \geq -\Pi(x_i). \quad (2.20)$$

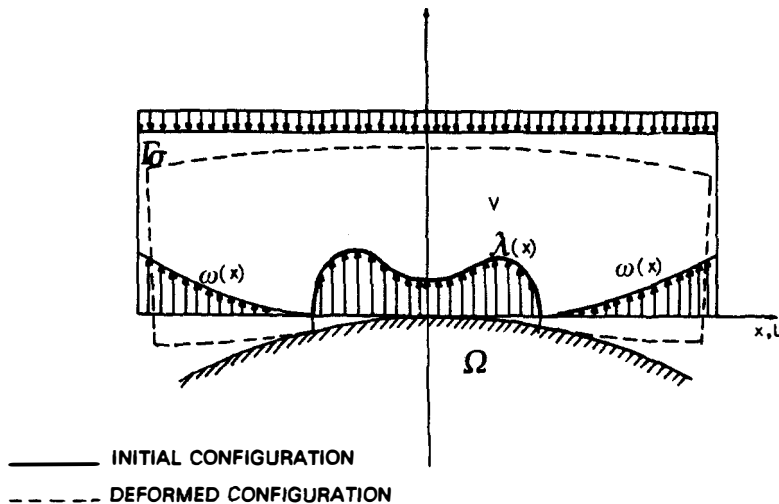

Fig. 2.

Now, let us consider an arbitrary finite element V_e with an interface Γ_e belongs to Γ_c . Let s the current coordinate defined on Γ_e . Let q_{re} be a system of nodal displacements chosen on Γ_e in adopting a system of shape function $M_e(s)$ for $u(s)$

$$u(s) = M_e(s)q_{re}. \quad (2.21)$$

Let $N_e(s)$ be another system of shape function corresponding to the nodal system λ_e of Lagrange's parameter λ

$$\lambda(s) = \lambda_e^T N_e(s). \quad (2.22)$$

According to (2.20), (2.21) and (2.22) the contact potential (2.19) of element V_e may reduce to this matrix form

$$\Phi_{ce} = \lambda_e^T (A_e q_{re} + h_e) \quad (2.23)$$

with

$$h_e = \int N_e \Pi \, d\Gamma_{ce} \quad (2.24)$$

$$A_e = \int N_e (\nabla \Pi)^T M_e \, d\Gamma_{ce}. \quad (2.25)$$

The assemblage of the contact elements may be performed by using some Boolean matrices L_e, G_e

$$q_{re} = L_e q_r \quad (2.26)$$

$$\lambda_e = G_e \lambda.$$

$$h_e = G_e^T h \quad (2.27)$$

and writing the total contact potential as the sum of the contact potential of each element

$$\Phi_c = \sum_e \Phi_{ce} = \lambda^T (A q_r + h) \quad (2.28)$$

where

$$A = \sum_e G_e^T A_e L_e$$

is the constraint matrix of the contact problem. Taking the variation of (2.28) with respect to λ the problem (2.10) gives the following linear constraint in terms of the nodal displacements defined on Γ_c :

$$A q_r \geq -h. \quad (2.30)$$

2.4 Superelement technique

Let

$$g_0 = A^T \lambda \quad (2.31)$$

be the generalized contact forces vector. The constraint affects only the nodal displacement defined on Γ_c . In order to reduce the size of the problem before the optimization process, the superelement technique is used. Application of the principle of virtual work for the entire structure

$$\delta [\frac{1}{2} q^T K q - g^T g - g_0^T q_r - \lambda^T h] = 0 \quad (2.32)$$

gives the nodal equilibrium equation

$$\begin{aligned} K_{cc} q_c + K_{cr} q_r &= g_c \\ K_{rc} q_c + K_{rr} q_r &= g_r + g_0 \end{aligned} \quad (2.33)$$

where q_c are the condensed displacements which must be eliminated before the optimization step

$$q_c = K_{cc}^{-1} [g_c - K_{cr} q_r]. \quad (2.34)$$

Replacing in (2.33) one obtains

$$\bar{K}_{rr} q_r = \bar{g}_r + g_0 \quad (2.35)$$

with

$$\bar{K}_{rr} = K_{rr} - K_{rc} K_{cc}^{-1} K_{cr} \quad (2.36)$$

$$\bar{g}_r = g_r - K_{rc} K_{cc}^{-1} g_c. \quad (2.37)$$

Now the size of the problem (2.32) is considerably reduced

$$\delta [\frac{1}{2} q_r^T \bar{K}_{rr} q_r - \bar{g}_r^T q_r - \lambda (A q_r + h)] = 0 \quad (2.38)$$

which is equivalent to the following quadratic programming problem:

$$\begin{aligned} &\text{minimize} \quad [\frac{1}{2} q_r^T \bar{K}_{rr} q_r - \bar{g}_r^T q_r] \\ &q_r \\ &\text{subjected to} \quad A q_r \geq -h. \end{aligned} \quad (2.39)$$

Once the optimal solution q_r and the associated Lagrange parameters λ are known, the internal displacements and stresses of the whole structure are obtained from (2.34) by back substitution and the contact force vector from (2.31).

2.5. Example

It seems useful to illustrate the above finite element formulation of the contact potential Φ_c by taking a simple example shown by Fig. 3. If V_e is a linear finite element having an interface 1-2 belongs to Γ_c one has the following interpolation matrix M_e and displacement q_{re} of formulae (2.21)

$$M = \begin{vmatrix} 1 - \eta & 0 & \eta & 0 \\ 0 & 1 - \eta & 0 & \eta \end{vmatrix} \quad \eta = s/l$$

$$q_{re}^T = [q_{11} \quad q_{12} \quad q_{21} \quad q_{22}]$$

where s is the current coordinate on the interface 1-2 and l is its length. If linear interpolation is taken for $\lambda(s)$ in (2.22) one has

$$\lambda_e^T = [\lambda_1 \quad \lambda_2]$$

$$N_e(s) = [1 - \eta \quad \eta].$$

In these conditions the constraint matrix A_e defined by (2.25) takes the following form:

$$A_e = l \begin{vmatrix} A_{11} & A_{12} & A_{13} & A_{14} \\ A_{21} & A_{22} & A_{23} & A_{24} \end{vmatrix}$$

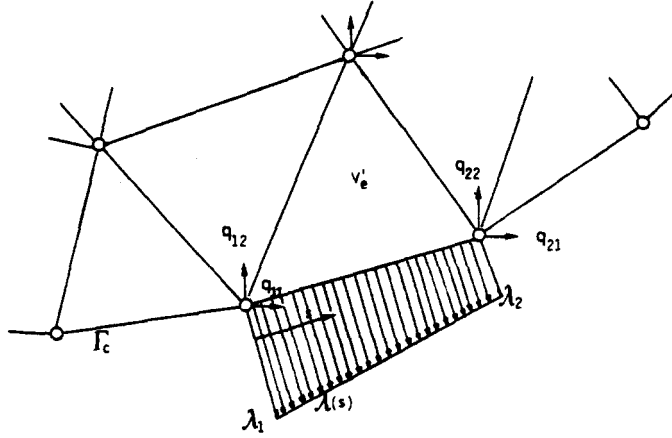

Fig. 3.

with

$$A_{11} = \int_0^1 (1 - \eta)^2 D_1 \Pi(\eta) d\eta$$

$$A_{12} = \int_0^1 (1 - \eta)^2 D_2 \Pi(\eta) d\eta$$

$$A_{13} = \int_0^1 (1 - \eta) \eta D_1 \Pi(\eta) d\eta$$

$$A_{14} = \int_0^1 (1 - \eta) \eta D_2 \Pi(\eta) d\eta$$

$$A_{21} = \int_0^1 (1 - \eta) \eta D_1 \Pi(\eta) d\eta$$

$$A_{22} = \int_0^1 (1 - \eta) \eta D_2 \Pi(\eta) d\eta$$

$$A_{23} = \int_0^1 \eta^2 D_1 \Pi(\eta) d\eta$$

$$A_{24} = \int_0^1 \eta^2 D_2 \Pi(\eta) d\eta.$$

In the case of the Fig. 4 where the rigid foundation is a circle of equation

$$\Pi(x_1, x_2) = x_1^2 + x_2^2 + 2x_2 R.$$

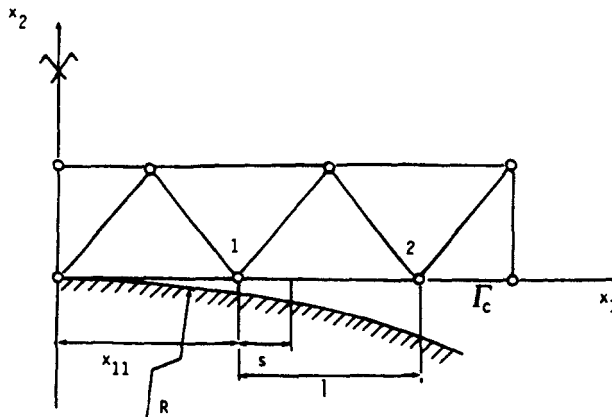

Fig. 4.

One has

$$D_1 \Pi = 2l(x_{11}/l + \eta); \quad D_2 \Pi = 2R.$$

Hence

$$A_e = \frac{l^2}{3} \begin{vmatrix} 2(x_{11}/l + \frac{1}{2}) & 2R/l & x_{11}/l + \frac{1}{2} & R/l \\ (x_{11}/l + \frac{1}{2}) & R/L & 2(x_{11}/l + \frac{3}{2}) & 2R/l \end{vmatrix}$$

and the matrix h_e defined by (2.24) is

$$h_e^T = l^3 \left[\frac{1}{2} \left(\frac{x_{11}}{l} \right)^2 + \frac{1}{3} \frac{x_{11}}{l} + \frac{1}{2} \right] \frac{1}{2} \left(\frac{x_{11}}{l} \right)^2 + \frac{x_{11}}{3l} + \frac{1}{4}.$$

3. CONTACT OF TWO ELASTIC BODIES

3.1. Formulation

The major difficulty for the extension of two elastic bodies consists on the fact that not only the contact zone is unknown here but the contact surface may deform during loading. We can take the boundary of one body as reference like the rigid foundation in the previous section but to do so we lost the symmetric feature of the problem. We do not treat the two body equally. For these reasons, we propose a new and general formulation described in the following. Let V_A , V_B (Fig. 5) two elastic bodies in contact with respectively Γ_{AC} , Γ_{BC} the possible contacting boundaries and Γ_{Ae} , Γ_{Be} the portion of boundaries where

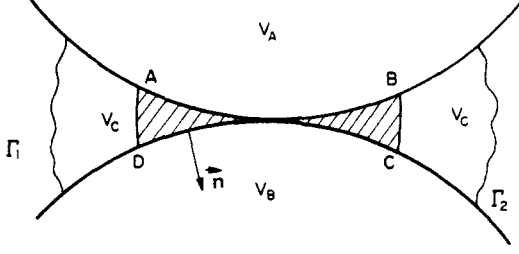

Fig. 5.

loading \bar{t}_i is prescribed. Let $V = V_A \cup V_B$ the total volume of the two elastic bodies and $\Gamma_\sigma = \Gamma_{A\sigma} \cup \Gamma_{B\sigma}$ the portion of its boundary where \bar{t}_i are prescribed. Let V_C is the region adjacent to the contact surface. This region has $\Gamma_C = \Gamma_{AC} \cup \Gamma_{BC}$ as boundary and some frontier $\Gamma = \Gamma_1 \cup \Gamma_2$ which joints Γ_{AC} and Γ_{BC} to limit the region V_C . It may be multiple if the V_A and V_B are initially in contact. The basic assumption of the formulation is that the displacement field existing in V may be extended in V_C which may be considered as a fictitious material defined afterwards. Let x_i be the Lagrangian coordinates of the material point. Under loading the configuration changes:

$$x_i \rightarrow \xi_i = x_i + u_i \quad (3.1)$$

and V_A, V_B, V_C become respectively the deformed Z_A, Z_B, Z_C . The associated Jacobian matrix of transformation (3.1) is

$$J_{ij} = D_i \xi_j = \delta_{ij} + D_i u_j \quad (3.2)$$

with the so-called determinant, or simply Jacobian

$$J = \det [J_{ij}]. \quad (3.3)$$

The volume of the fictitious material is reduced to the value

$$Z_C = \int_{V_C} dZ_C = \int_{V_C} J dV_C. \quad (3.4)$$

The narrow volume V_{C0} nearly the elastic bodies and limited by AB, CB is the seat of important strain and tends to zero as far as loading increases. Therefore it is evident that for a small element of volume in V_{C0} the contact between V_A and V_B is realized when

$$J = 0 \quad (3.5)$$

otherwise, the condition of non-interpenetration would be

$$J \geq 0 \quad (3.6)$$

and displacement field is called kinematically admissible in contact problem sense if it satisfies (3.6).

Now, the same formulation (2.9), (2.10) may be used here with only the following change for the dislocation potential:

$$\phi(u_i, \lambda, \omega) = -\int \lambda (J - \omega^2) dV_C \quad (3.7)$$

with the new contact potential

$$\Phi_C = \int \lambda J dV_C. \quad (3.8)$$

Noting that

$$I_{ij} = \frac{\partial J}{\partial J_{ij}} \quad (3.9)$$

is the minor of element J_{ij} of the Jacobi matrix $[J_{ij}]$, one has

$$\delta \Phi_C = \int \lambda \frac{\partial J}{\partial J_{ij}} \delta J_{ij} dV_C$$

and because of (3.2)

$$\delta \Phi_C = \int \lambda I_{ij} D_i \delta u_j dV_C = \int D_i (\lambda I_{ij} \delta u_j) dV_C - \int D_i (\lambda I_{ij}) \delta u_j dV_C \quad (3.10)$$

and according to the Gauss formulae

$$\delta \Phi_C = \int \lambda n_i I_{ij} \delta u_j d\bar{\Gamma} \times \int D_i (\lambda I_{ij}) \delta u_j dV_C$$

with

$$\bar{\Gamma} = \Gamma_C \cup \Gamma, \text{ the total boundary of } V_C.$$

Taking the variation of the modified functional

$$\Phi^*(u_i, \lambda, \omega) = \Phi(u_i) + \phi(u_i, \lambda, \omega) \quad (2.9)$$

where $\Phi(u_i)$ is defined by (2.4), we may find the following Euler-Lagrange's equations:

$$\text{in } V \quad D_j \sigma_{ij} + \bar{f}_i = 0 \quad (3.11)$$

$$\text{on } \Gamma_\sigma \quad n_j \sigma_{ij} = \bar{t}_i \quad (3.12)$$

$$\text{on } \Gamma \quad n_j \sigma_{ij} = 0 \quad (3.13)$$

$$\text{on } \Gamma_C \quad t_j = \lambda n_i I_{ij} \quad (3.14)$$

$$\text{in } V_C \quad D_i (\lambda I_{ij}) = 0. \quad (3.15)$$

3.2. Physical interpretations

The three first equations are classical equilibrium equations. Focusing our attention on the two last new ones to give some physical interpretations. We recognize in (3.14) the presence of the normal v_j (Fig. 6) of the strained surface Γ_C

$$v_j = n_i I_{ij} \quad (3.16)$$

so that it may be written

$$t_j = \lambda v_j. \quad (3.17)$$

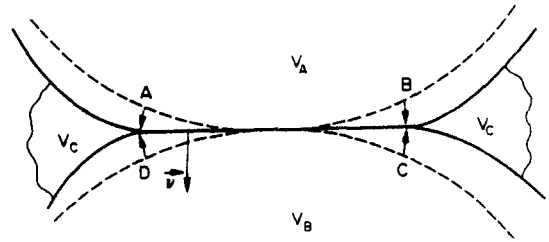

Fig. 6.

and due to the fact that the displacements are small

$$\mathbf{n} = \nabla \Pi(\mathbf{u} = 0) = D_k \Pi(\mathbf{u} = 0). \quad (3.32)$$

According to (3.27), (3.30), (3.31) and (3.32) the non-interpenetration condition (3.6) leads to

$$D_k \Pi(\mathbf{u} = 0) u_k > -\Pi(\mathbf{u} = 0) \quad (3.33)$$

which is nothing else but the linearized inequality (2.20) already obtained in Section 2.

The unity of the two formulations has been demonstrated.

4. NUMERICAL RESULTS

Computing program of the rigid-elastic contact formulation exposed in Section 2 is realized by connecting the finite element algorithm ADELEF existing in our department to the mathematical programming code called ACDPAC developed by Best and Bowler [9]. The types of finite element used alternatively in the numerical examples are the isoparametric quadrangle proposed by Ergatoudis [10], Argyris and Fried [11] and the hybrid triangle proposed by Nguyen Dang Hung [12]. The latter element has the following displacement field on the interfaces

$$\begin{aligned} u &= \alpha_1 + \alpha_2 x + \alpha_3 y + \alpha_4 x^2 + \alpha_5 xy + \alpha_6 y^2 \\ v &= \alpha_7 + \alpha_8 x + \alpha_9 y + \alpha_{10} x^2 + \alpha_{11} xy + \alpha_{12} y^2 \end{aligned}$$

and the stress field may have arbitrary degree derived from adopted general Airy's stress function

$$F = \sum_{i=0}^n \sum_{j=0}^i \beta_{ij} x^i y^j.$$

This element belongs to a very efficient class of hybrid elements named the mongrel elements discussed in [13] and [14]. Externally, this element posses the same

number of degree of freedom as the classical conforming quadratic triangle.

4.1. Hertz's problem

The classical contact problem of an infinite elastic cylinder on a rigid semi-infinite medium (Fig. 8) is tested. The analytical solution of the problem has been given early by Hertz [15]. Geometric and mechanic data of the example are

$$\begin{aligned} R &= 1000 \text{ mm} & E &= 21.000 \text{ kg mm}^{-2} \\ \nu &= 0.3 & P &= 600 \text{ kg mm}^{-1}. \end{aligned}$$

Taking the advantage of the symmetry, only a half of the infinite cylinder is discretized in triangle elements. The mesh is shown successively by Figs. 8, 9, 10 and 11. For this pattern 80 mongrel triangles are necessary with 394 degrees of freedom. The number of interface constraint elements is 16 with 36 degrees of freedom. The Fig. 12 illustrates the distribution of the pressure along the contact surface AB . The dotted curve is the analytical Hertz's results. The black points indicate the present results. Agreement between analytical and finite element results is satisfactory.

The CPU of this problem is 26 sec on IBM 370-158 at University of Liège. The Fig. 13 presents the nodal forces g_0 obtained directly in output. We may see that the coincidence with the Hertz's ellipse is more regular because the fact that the forces are relaxed by the interpolation shape function. One may distinguish the upper curve which is the forces taken from the mid-points of the contact elements and the lower curve from the connected vertex of the same elements.

4.2. Piston rod

Figure 1 shows how a piston rod acts on a pin under an external force F distributed along Γ_σ . A clearance exists before loading and the two solids are initially in contact on the top

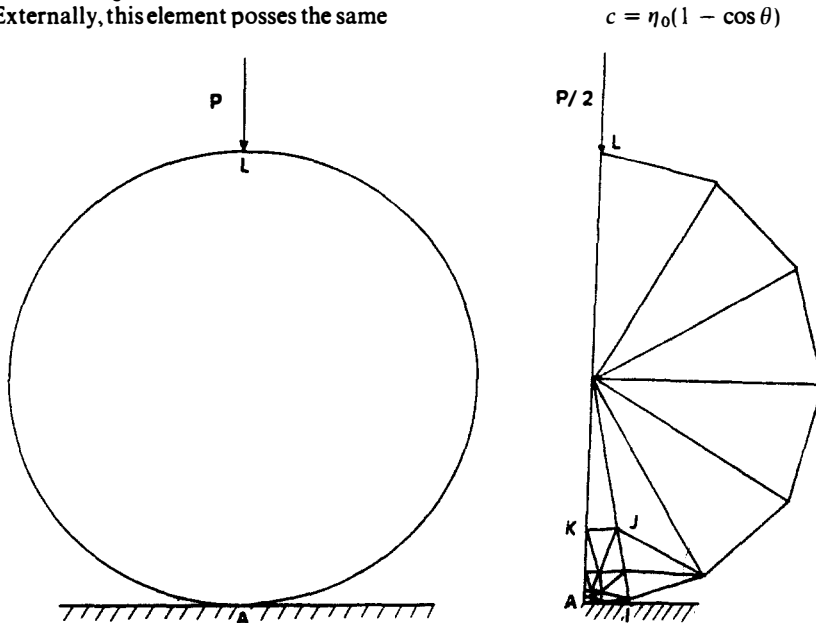

Fig. 8. Hertz's problem discretization of a semi-area of the cylinder.

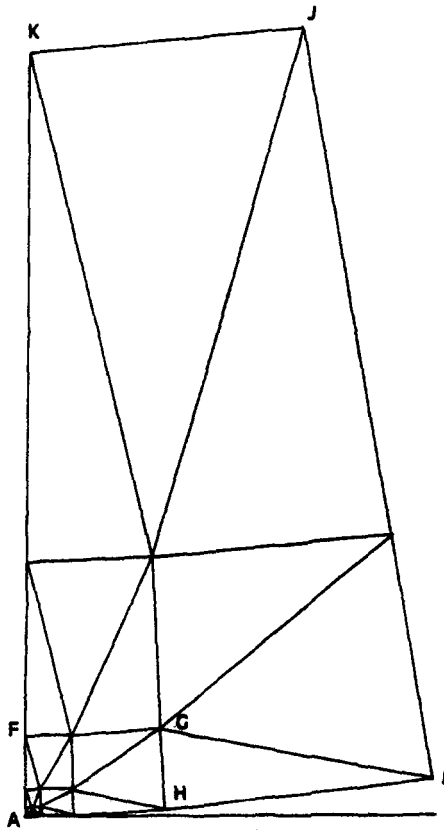

Fig. 9. Finite element mesh of region AKJI.

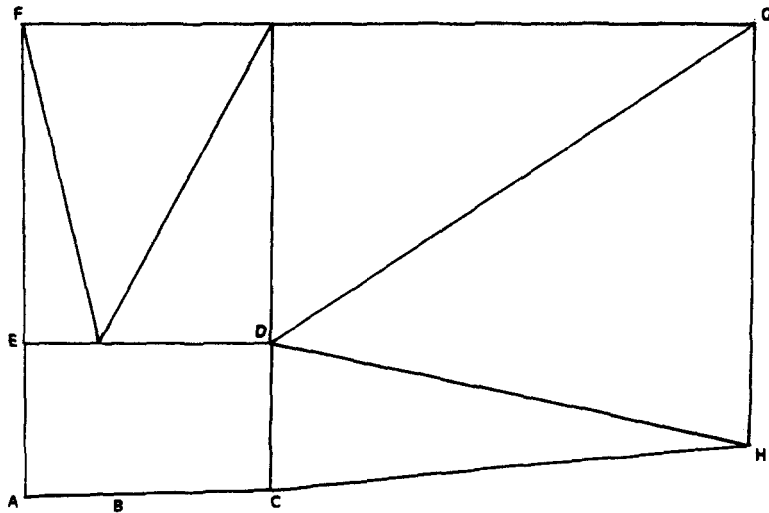

Fig. 10. Finite element mesh of region AFGH.

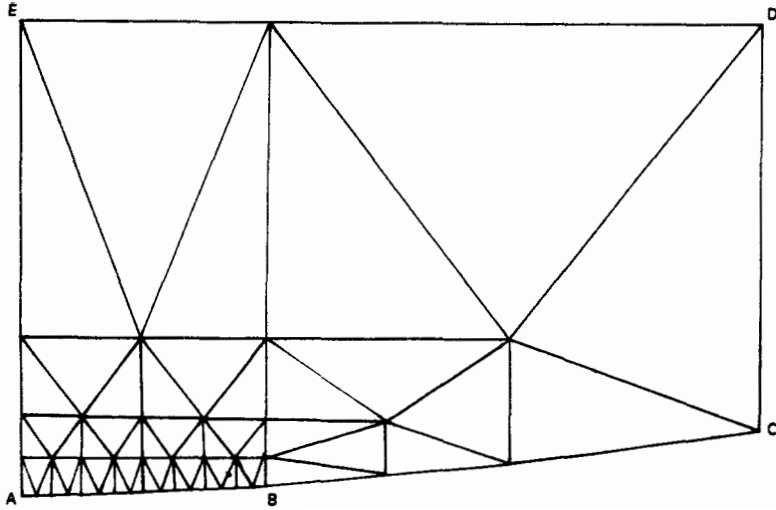

Fig. 11. Finite element mesh of region AEDC.

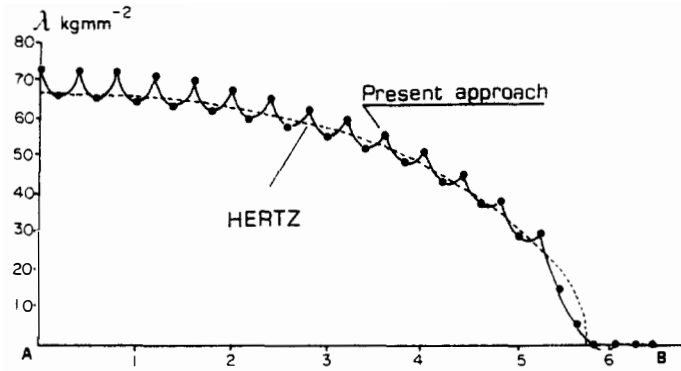

Fig. 12. Comparison of the distribution of the pressure along the contact surface.

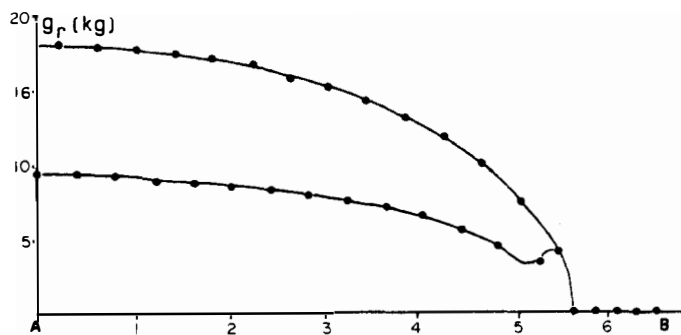

Fig. 13. distribution of the nodal forces along the contact surface.

where

$$\eta_0 = R_i - R_e$$

is the initial gap between the radius of the hole on the rod and of the pin. Following geometric data is chosen for present test:

$$\begin{aligned} E &= 7288 \text{ kg mm}^{-2} & \nu &= 0.32 \\ t \text{ (thickness)} &= 19.8 \text{ mm} \\ R_i &= 41 \text{ mm} & R_e &= 55.5 \text{ mm} \\ F &= 612 \text{ kg (Fig. 14).} \end{aligned}$$

Again the symmetry allows to discretized only a half of the structure using 48 isoparametric elements. The connecting rod is considered as elastic but the shaft as rigid. The constraint function is the equation of the boundary of the pin

$$\Pi(\xi, \eta) = \xi^2 + (\eta - \eta_0)^2 - R_a^2 \geq 0.$$

The pattern (Fig. 14) needs 394 degrees of freedom with 15 contact elements corresponding to 62 degrees of freedom.

Figures 15–17 illustrate some results for the case $\eta_0/R_i = 0.003$. Distributed pressures $\lambda(\theta)$ along the

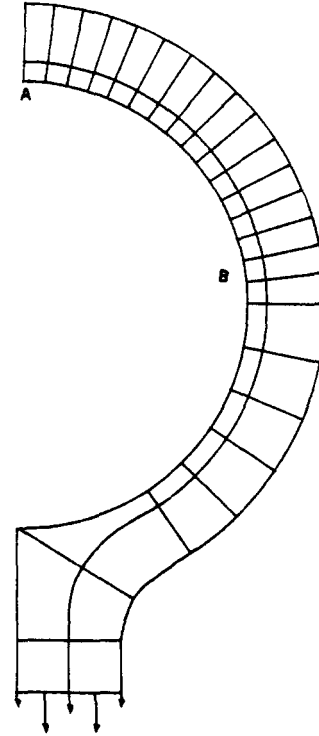

Fig. 14. Finite element mesh-the semi-area of the piston rod.

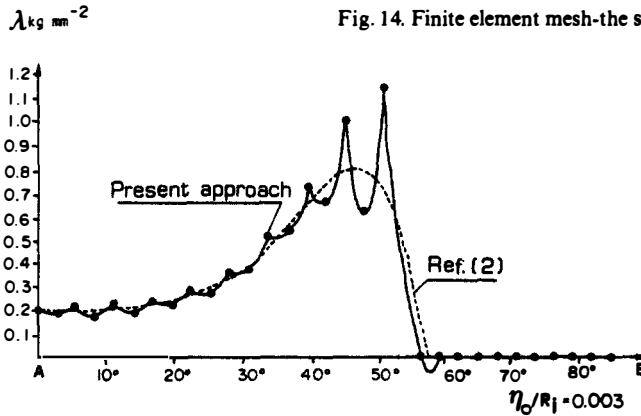

Fig. 15. Comparison of the distribution of the pressure along the contact surface.

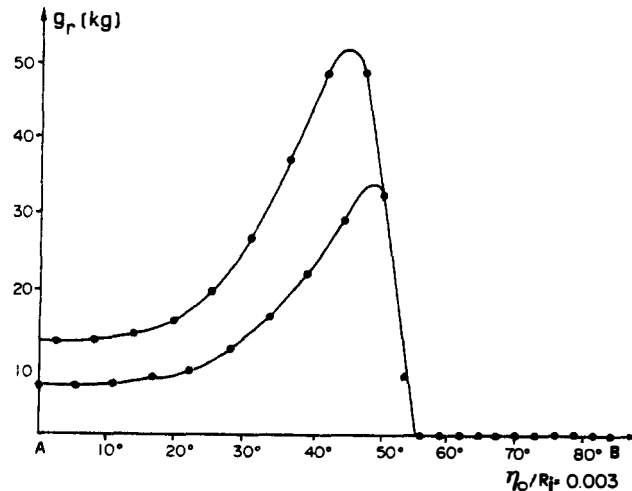

Fig. 16. Distribution of the nodal forces along the contact surface.

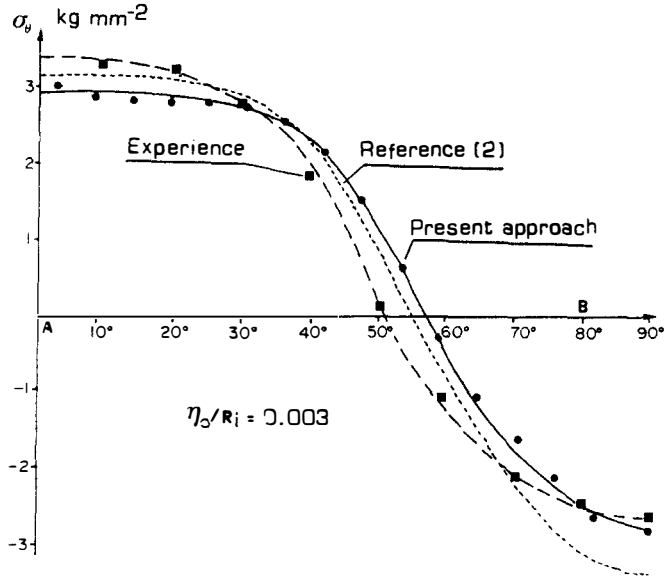

Fig. 17. Comparison of the distribution of the external circumferential stress.

angular contact and the distributed pressure of 3 cases $\eta_0/R_i = 0.008, \eta_0/R_i = 0.003, \eta_0/R_i = 0.001$ is given by Figure 18. It is seen that for large clearance, the pressures distribution tends rapidly to elliptic form of the Hertz's analytical results.

5. CONCLUSIONS

Dealing with the frictionless contact problem of elastic bodies the paper presents a procedure of linearization of the non-interpenetration condition in order to realize a modelling of the contact surface into contact finite elements. This method renders the optimization problem convex and the convergence is assured. Numerical experiences for rigid-elastic contact case are very encouraging.

Extension to the elastic contact problem leads to a new concept of considering the adjacent space near the contact surfaces as a perfectly locking material. The introduction of a symmetrical non-interpenetration

condition permits to formulate elegantly the frictionless contact problem of two elastic bodies. This very promising formulation may be reduced to the rigid elastic contact problem under small displacements conditions. We hope to present in the near future the numerical results of this, and the dual formulation using equilibrium finite elements.

REFERENCES

1. S. H. Chan and I. S. Tuba, A finite element method for contact problems of solid bodies. *Int. J. Mech. Sci.* 13, 615-639 (1971).
2. R. Gaertner, Investigation of plane elastic contact allowing for friction. *Comput. Structures* 7, 59-63 (1975).
3. A. Francavilla and O. C. Zienkiewicz, A note on numerical computation of elastic contact problems. *Int. J. Num. Meth. Eng.* 9, 913-924 (1975).
4. B. Fredriksson, Finite element solution of surface nonlinearities in structural mechanics with special emphasis to contact and fracture mechanics problems. *Comput. Structures* 6, 281-290 (1976).
5. W. W. Feng and P. Huang, On the general contact problem of an inflated non-linear plan membrane. *Int. J. Solids Structure* 11, 437-448 (1975).
6. M. Fremond, Etude des Structures visco-élastiques stratifiées soumises à des charges harmoniques et de solides élastiques reposant sur des structures. Thèse Université de Paris (1971).
Formulation duale des énergies potentielles et complémentaires. Application à la méthode des éléments finis. C.R. Ac. Sc. Paris, série A, pp. 775-777.
7. P. D. Panagiotopoulos, A nonlinear programming approach to the unilateral contact- and friction-boundary value problem in the theory of elasticity. *Ingénieur-Archives* 44, 421-432 (1975).
8. Nguyen Dang Hung, Modèles mathématiques et calcul numérique du comportement inélastique des matériaux. Notes de cours, Laboratoire de Mécanique des Matériaux et de Statique des Constructions, Université de Liège (1978).
9. M. J. Best and A. T. Bowler, ACDPAC, A FORTRAN IV Subroutine to solve differentiable mathematical Programmes User's Guide. Level 2.0 (1976).

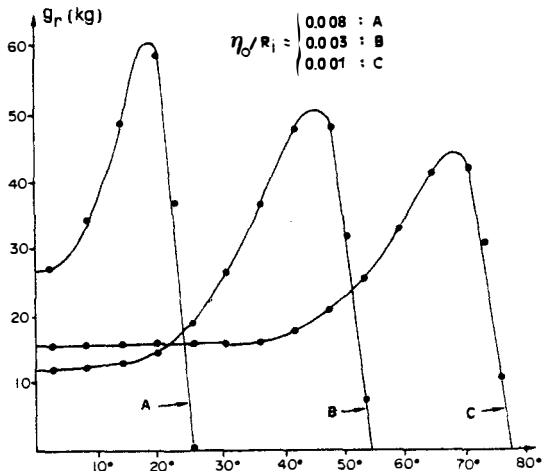

Fig. 18. Nodal forces distribution for different clearance for $F = 612 \text{ kg}$.

10. J. G. Ergatoudis, Isoparametric elements in two and tridimensional analysis. Ph.D. Thesis Univ. Wales, Swansea (1969).
11. J. H. Argyris and I. Fried, The LUMINA element for the matrix displacement method. *Aero J. ROY Aero soc.* **72**, 514 (1968).
12. Nguyen Dang Hung, Direct limit analysis via rigid-plastic finite elements. *Com. Meth. in Appl. Mech. and Eng.* **8**, 81-116 (1976).
13. Nguyen Dang Hung, Sur une classe particulière des éléments finis hybrides: les éléments métis. *Méthodes Numériques dans les Sciences de l'Ingénieur" Proc. GAMNI Cong. 22 November to 1st December 1978*, (Edited by DUNOD TECHNIQUE), pp. 53-63, Paris (1979).
14. Nguyen Dang Hung, On the monotony and the convergence of a special class of hybrid finite elements: the MONGREL Elements. IUTAM Symposium of variational method in the Mechanics. Northwestern University, Evanston, Illinois, U.S.A. 11-13 septembre 1978.
15. H. Hertz, Über die Berührung fester elastischer Körper. *J. für Math.* **92**, 156-171 (1882).