



**HAL**  
open science

# Use of reluctance network modelling and software component to study the influence of electrical machine pole number on hybrid electric vehicle global optimization

Mathias Le-Guyadec, Laurent Gerbaud, Emmanuel Vinot, Vincent Reinbold,  
Come Dumont

## ► To cite this version:

Mathias Le-Guyadec, Laurent Gerbaud, Emmanuel Vinot, Vincent Reinbold, Come Dumont. Use of reluctance network modelling and software component to study the influence of electrical machine pole number on hybrid electric vehicle global optimization. *Mathematics and Computers in Simulation*, 2018, 22 p. 10.1016/j.matcom.2018.06.001 . hal-01826120

**HAL Id: hal-01826120**

**<https://hal.science/hal-01826120>**

Submitted on 21 Oct 2021

**HAL** is a multi-disciplinary open access archive for the deposit and dissemination of scientific research documents, whether they are published or not. The documents may come from teaching and research institutions in France or abroad, or from public or private research centers.

L'archive ouverte pluridisciplinaire **HAL**, est destinée au dépôt et à la diffusion de documents scientifiques de niveau recherche, publiés ou non, émanant des établissements d'enseignement et de recherche français ou étrangers, des laboratoires publics ou privés.



Distributed under a Creative Commons Attribution - NonCommercial 4.0 International License

# Use of Reluctance Network Modelling and software component to study the influence of Electrical Machine pole number on Hybrid Electric Vehicle global optimization.

M. Le Guyadec<sup>a,b</sup>, L. Gerbaud<sup>b</sup>, E. Vinot<sup>a</sup>, V. Reinbold<sup>c</sup>, C. Dumont<sup>b</sup>

<sup>a</sup>Univ Lyon, IFSTTAR, AME, LTE, F-69675, LYON, France

<sup>b</sup>Univ. Grenoble Alpes, CNRS, Grenoble INP\*, G2Elab, 38000 Grenoble, France

\*Institute of Engineering Univ. Grenoble Alpes

<sup>c</sup>Université de Louvain, Belgique.

---

## Abstract

In the paper, the global optimization of hybrid electric vehicle (HEV) components and control is performed using genetic algorithm and dynamic programming. Reluctance network modelling (RNM) is used to describe the behaviour of the electrical machine (EM). The pole number is considered as a design variable in the EM model. A software component is built from this model and is used in Matlab for a sizing by optimization. The influence of the EM pole number on the system optimization is analysed. Contrary to the low differences observed on the energy efficiency of the vehicle, the machine shape is highly impacted.

*Keywords:* Hybrid Electric Vehicle, global optimization, Interior Permanent Magnet Synchronous Machine, pole number, Reluctance Network Model, software component.

---

## 1. Introduction

Nowadays, transportation is one of the main sources of greenhouse gas emissions [1] and pollutants. Hybrid electric vehicles (HEV) are a serious alternative to reduce the emissions of the conventional vehicles. Energy recovery at braking can indeed save up to 30% fuel on urban driving conditions.

---

*Email address:* [mathias.le-guyadec@ifsttar.fr](mailto:mathias.le-guyadec@ifsttar.fr) (M. Le Guyadec)

*Preprint submitted to Trans. of IMACS on Mathematics and Computers in Simulation. March 8, 2018*

However, HEV are complex systems because the energy management, the size of the components and the driving conditions are strongly linked [2]. For instance, it is difficult to size separately the electrical machine (EM) because its own operating cycle depends on the other component sizing and on the energy management of the HEV. The EM operating cycle has to be predetermined from the vehicle cycle with considerations on the management of the system. Besides, the characteristics of the components may influence the energy management. For example the management can be adapted to the best efficiency area of the EM [3, 4].

The approach used in the paper considers the entire system with these interactions. As shown in Fig. 1, the paper deals with a parallel hybrid architecture of HEV. A global optimization process [3] is used to minimize the fuel consumption of the vehicle over a driving cycle. The components and their energy management are sized by this process thanks to the combination of two optimization algorithms: non-dominated sorting genetic algorithm (NSGA-II) and dynamic programming. This kind of approaches have been reviewed [5] and used [6, 7, 8, 9].

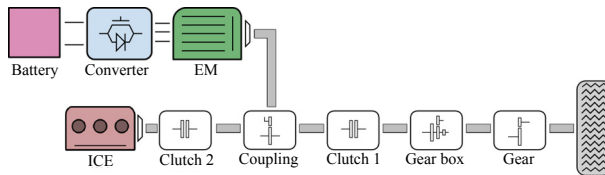

Figure 1: Hybrid parallel architecture with two clutches.

A specific electromagnetic model based on reluctance network modelling (RNM) is used to size precisely the electrical machine. This kind of model has a low computation time which is necessary in the context of a systemic optimization. CADES [10] framework is used to build a software component (MUSE standard [11]) containing the reluctance network model obtained from a reluctance schematic. This software component is a black box model which can be plugged inside several software tools. In our case, Matlab is used as the

upper level and calls the model during the global optimization process. The number of calls can be very high (about 20 million for the process). The RNM running time becomes then a key point when running the global optimization many times. Therefore, the simplification of the RNM thanks to symmetries and periodicities is considered.

First, the paper presents the global optimization process. NSGA-II and dynamic programming algorithms are introduced. Then, the EM model using a reluctance network is presented and compared to a finite element analysis. The building of the software component and its use in the global sizing process are also introduced. Finally, the comparative study discussing the influence of the pole number is detailed.

## 2. Optimization process

### 2.1. Description

In this work, the HEV is considered as a system described by 16 variables, where 11 deals with a geometrical description of the EM (Fig. 2), including the pole number. The other 5 are used to describe the remaining components such as gear ratios, the internal combustion engine (ICE), etc.

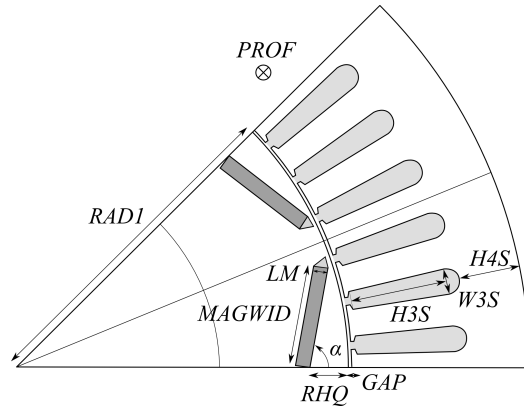

Figure 2: EM sizing variables.

The sizing process leads to the minimization of the fuel consumption of

the vehicle on the Hyzem urban driving cycle [12]. This is achieved by the combination of the component sizing and their optimal energy management. As presented in Fig. 3, the multi-objective algorithm NSGA-II [13] is used to explore the domain of feasible solutions. The energy management is considered as a sub-problem, and is solved by Dynamic Programming [14] at each step of the optimization process.

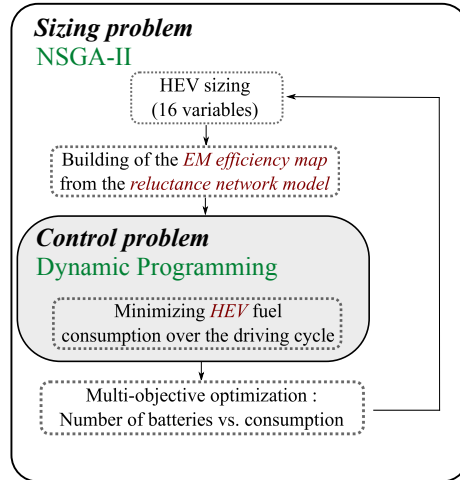

Figure 3: Optimization process.

## 2.2. NSGA-II

The non-dominated sorting genetic algorithm (NSGA-II) [13] is chosen to solve the sizing problem. This stochastic-based algorithm is well suited to solve non-convex problems with few variables. NSGA-II is a multi-objective algorithm, looking for a global solution, allowing to find a trade-off between several objectives.

Its main drawbacks are a high computation time caused by a high number of calls of the model and its difficulty to deal with numerous constraints. Table 1 presents the parameters chosen to get the best compromise between accuracy and computation time for the studied application. The other settings of the algorithm have quite no influence on the results.

Table 1: NSGA-II settings.

<b>Parameter</b>	<b>Value</b>
Population size	100
Number of iteration	200
Crossover/Mutation rate	90%/10%

As described in [13], NSGA-II is not adapted to discrete variables. In a first approach, a closed set of pole number values around the reference<sup>1</sup> is used: [2; 4; 6; 8; 10; 12]. The pole number values are considered sequentially. For each value, the optimization of all other variables is carried out. Hence, the non-continuous problem is replaced by 6 continuous problems: for each value of the pole number, an NSGA-II process is performed for the 15 remaining variables, where 10 are dedicated to the geometry of the EM and 5 to the other components of the HEV which are presented in section 3.2.

After the initialization of a random population of HEV, the algorithm follows several steps at each iteration:

- some individuals are selected through a non-domination sorting process;
- then, those individuals are used in an evolution process: a cross-over (90% of the cases) or a polynomial mutation (10%) is applied, to maintain the diversity in the evolving population;
- each individual of the resulting offspring population is evaluated regarding the objectives: the sizing of the battery pack (number of modules) and the fuel consumption assessment on driving cycle considering optimal energy management (Fig. 4);
- finally the best solutions from the initial and the offspring populations are saved to be used during the next iteration.

---

<sup>1</sup>The 8-pole interior permanent magnet synchronous motor of the 2004 Toyota Prius (THSII) [15] is considered as the reference for the EM of the system. It has a rated power of 50 kW.

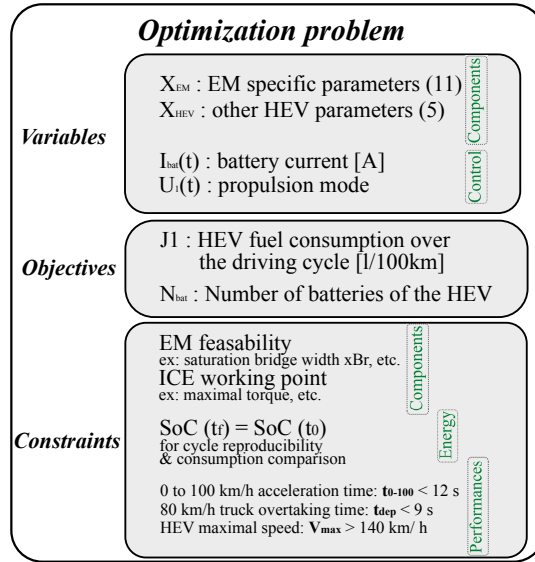

Figure 4: Summary of the optimization problem.

### 2.3. Dynamic Programming

The energy management is considered as a sub-problem, working on fixed values for the size of the components. A comparison of different sizing requires:

- an optimal energy management, to get a minimal fuel consumption for each sizing;
- a charge sustaining constraint on the cycle, to ensure neutral effect of the battery energy on the fuel consumption.

Dynamic programming [14] is well adapted for this case. The control problem is translated into a trajectory problem in a discretized space (state of charge (SoC) vs time). In fact, the knowledge of  $I_{bat}(t)$  (battery current) and  $u_1(t)$  (propulsion mode: hybrid or full electric) at each time step of the cycle, defines the entire system state [16]. So, the control problem is represented in Fig. 5 as the trajectory of the battery state of charge during the cycle. The solution is the trajectory that minimizes the HEV fuel consumption. Note that the initial and final SoC are equal as defined by the charge sustaining constraint.

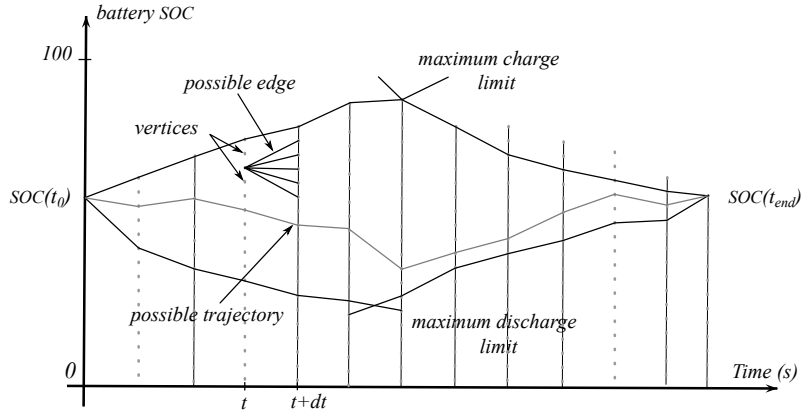

Figure 5: The control problem.

Fig. 4 summarizes the studied optimization problem. The EM and HEV models used in the process are more precisely described in the next sections.

### 3. Modelling

#### 3.1. Electrical machine modelling

##### 3.1.1. Description of the reluctance network model

The EM model developed in [3] is semi-analytical and quasi-static. A reluctance network modelling (RNM) is used. This approach is based on an equivalence between magnetic and electrical phenomena. The path of the magnetic flux through the EM can be represented by an equivalent electrical circuit. Cades-Reluctool software [17] is used to design the parametrized reluctance network. A non-linear model is used to represent the magnetic saturation in the iron parts (Fig. 6). The RNM is then solved thanks to a Newton-Raphson algorithm [18]. The main output is the static torque which is computed from the several inputs including:

- $X_{EM}$ : the EM variables described in Fig. 2 and the pole number;
- the stator current  $I_{EM}$ ;
- the control angle  $\psi$ .



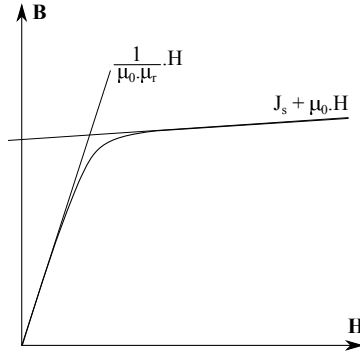

Figure 6: General shape of the curve linking the magnetic flux density  $B$  and the magnetic field intensity  $H$  in iron parts.  $\mu_0$  and  $\mu_r$  are the free space and the material relative permeability respectively, and  $J_s$  is the magnetic polarization.

Periodicities on the electrical distribution and on the geometry of the machine allow to reduce the model to a single pair of poles. This 2 poles model was the most simple model that can be built with the previous version of Reluctool [19]. Indeed, an anti-periodicity exists in the  $q$ -axis of the EM (Fig. 7). In fact,

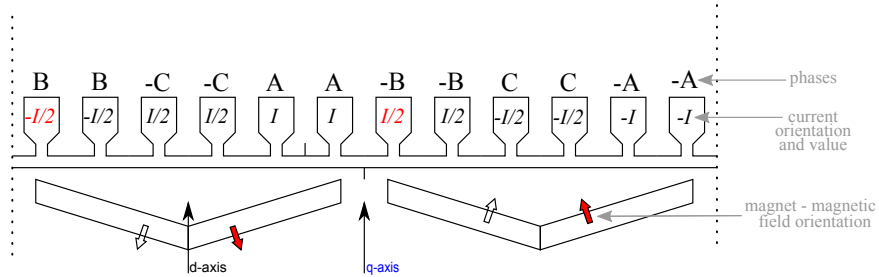

Figure 7: Representation of a pair of poles. There is an anti-periodicity on the sources in the  $q$ -axis. The control angle equals  $-\pi/6$  in this case.

the direction of the sources (current and permanent magnet) are opposed between two poles of the same pair of poles. It induces an anti-periodicity on the magnetic fluxes. For instance, it exists the following flux equality:  $F7 = -F1$  (Fig. 8). So the RNM can be reduced to a single pole thanks to the dedicated component proposed in the last version of Cades-Reluctool as shown in Fig. 8.

The simplification of the model reduces its computation time, which is more

appropriate in an optimization context. Moreover, models with 2 poles or less allow to work on EM with different numbers of pole pairs. Indeed, this variable has numerous impacts in the model. First, the pole number acts on the geometry (pole angle and number of slots as instance). Then, the current frequency and the performances (EM and static converter losses, highest efficiency area) are also impacted. The computation of the losses is presented in section 3.1.3 for the EM and then in section 3.2 for the other components of the HEV.

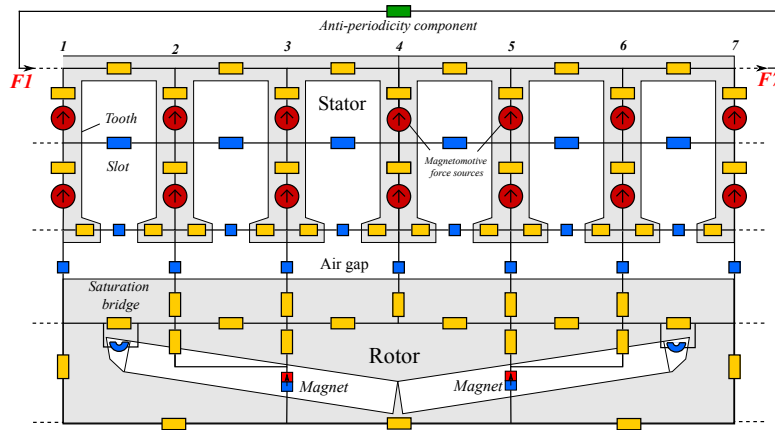

Figure 8: The RNM can be reduced to one pole thanks to the anti-periodicity component of Cades-Reluctool.

### 3.1.2. Validation of the reluctance network model

The RNM is built to fit the EM behaviour in the sizing domain given by the specifications (i.e. to respect the main paths of the magnetic flux with a good compromise between accuracy and computation time). Finite element simulations are used to validate the behaviour of the semi-analytical model with different values of the pole number. Finite element modelling (FEM) is more robust because the mesh is automatically adapted to each geometry and a fine discretization is easy to apply.

Fig. 9 presents a comparison of the static torque of the same 8-pole machine computed with Flux (FEM) and with Reluctool (RNM). The 8-pole interior permanent magnet synchronous motor of the 2004 Toyota Prius (THSII) [15]

is considered as the reference for the EM of the system. The same method is used for a 4-pole machine in Fig. 10. The torque depends on the stator current, the control angle, and the geometry. Results presented in Fig. 9 and 10 are computed at 100 A.

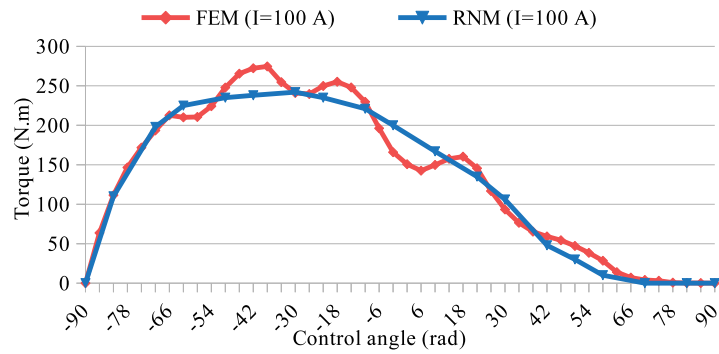

Figure 9: Torque validation of the 8-pole reference EM.

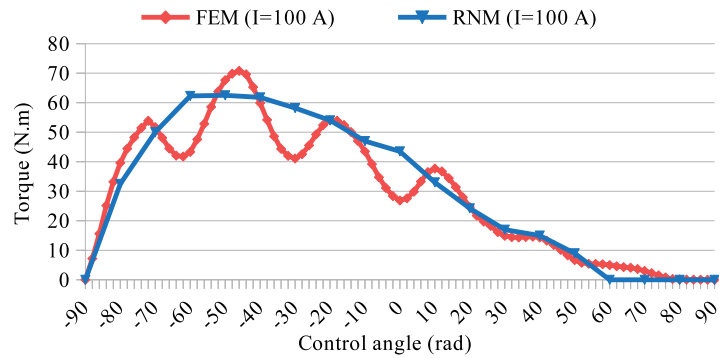

Figure 10: Torque validation of a 4-pole EM.

The cogging torque is neglected in the reluctance network model. Other phenomena such as the magnetic saturation could explain the differences<sup>2</sup>. How-

---

<sup>2</sup>During the driving cycle, the EM is operated at low torque and thus low current. The saturation will then have a small effect.

ever, Fig. 9 and 10 show that the torques computed with the reluctant model are in good agreement with those of the FEM. The semi-analytical model fits the average value obtain with the FEM in each case. 50 A and 200 A cases were also treated and the results lead to the same conclusions.

Then RNM will now be used to compute the torque and the magnetic field in each part of the EM for different values of current and control angle. Those results are then used to assess the losses in the EM and its efficiency.

### 3.1.3. Building of an efficiency map of the EM

To reduce the computation time of the EM model during the optimization process, an efficiency map in the speed-torque frame (Fig. 11) is built from the reluctance network model. Indeed the RNM is not fast enough to be directly

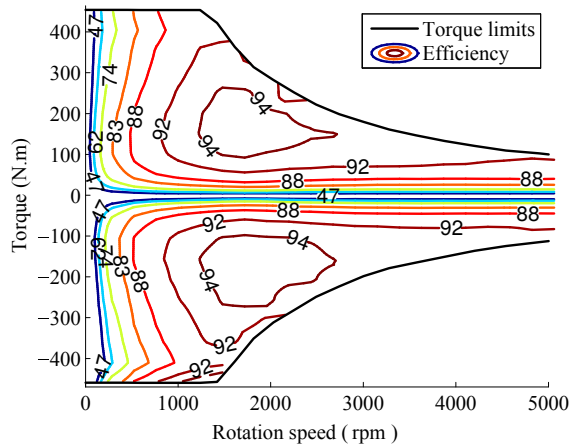

Figure 11: Efficiency map of an 8-pole EM.

used by dynamic programming. So, for each feasible EM sizing, a map is built (800 calls to the RNM), and then used during the energy management optimization thanks to linear interpolation. Dynamic programming needs in this case about 20,000 calls to the whole HEV model, to compute fuel consumption on each possible edge, as shown in Fig. 5, which is too expensive with direct call to RNM. A summary of the process is presented in Fig. 12. Several steps are followed to build the efficiency map:

- $I_{EM}$ ,  $\psi$  and the speed  $\Omega_{EM}$  spaces are sampled<sup>3</sup>;
- the RNM is computed for each couple  $\{I_{EM}, \psi\}$ . The magnetic fluxes and fields are deduced for each case;
- voltages, losses and torque are computed;
- voltage constraint is introduced;
- $\psi$  is chosen to maximise (minimize) the torque in motor (generator) phase respectively;
- the map is finally deduced thanks to linear interpolation.

The EM losses computation is composed of several elements. The copper losses are deduced from the current in the coils (Joule effect). The iron losses are evaluated using a Bertotti model with first harmonic assumption. Thus rotor iron losses are neglected. The mechanical losses are supposed to be dry frictions and are proportional to  $\Omega_{EM}$  and to the square of the external radius of the EM.

This losses model has been compared to measurements performed on the reference EM [20]. Less than 2% of error has been observed on the whole efficiency map.

#### 3.1.4. Implementation

In order to simulate and optimize the HEV system, the EM model has to be usable in Matlab. Indeed, as presented in the next section (3.2), the vehicle model was historically developed in Matlab-Simulink [21]. In this way, the building of an easy pluggable model using the MUSE standard [11] is appropriate.

MUSE is a standard for interoperability, capitalization and reuse of models and algorithms. It is more precisely called a software component. This stan-

---

<sup>3</sup>The maximum current is defined from magnetic and thermal limitations, and the maximum speed from the current and the available voltage.

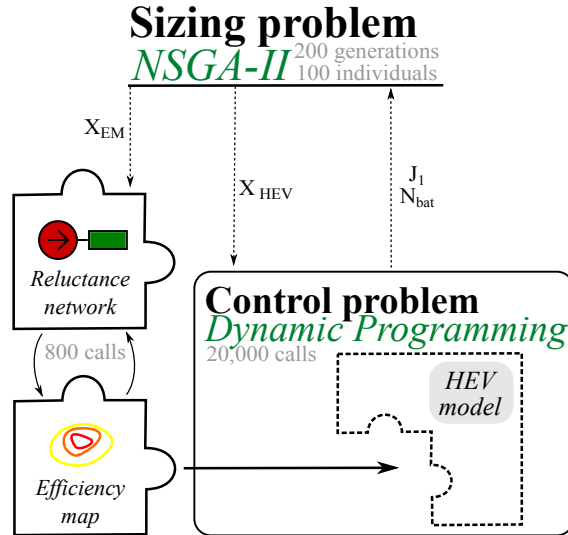

Figure 12: Use of the efficiency map during the optimization process. Remember that  $X_{EM}$  are the EM variables (Fig. 2) and  $X_{HEV}$  are the HEV variables (Section 3.2).  $J_1$  and  $N_{bat}$  are the two objectives (Fig. 4).

standard allows a communication between models using modelling languages such as Modelica or VHDL-AMS and standard modelling and analysis tools such as Matlab, Flux2D/3D, etc. An example is given in [22]. It is also compatible with the FMI standard [23].

The Cades framework, which includes Reluctool as well, is in fact the first native MUSE platform. The building and the use of the MUSE model embedding the RNM is presented in Fig. 13. Matlab can call the MUSE software component through a specific plug-in which knows how to interact with the model. Then, the methods embedded in the software component are usable in Matlab.

### 3.2. Vehicle model

The HEV model is described in VEHlib [21], a Matlab/Simulink library developed by IFSTTAR to simulate vehicle behaviours. A hybrid parallel architecture is chosen here, but the methodology is relevant for other architectures. VEHlib allows backward calculation, which is used to compute the fuel con-

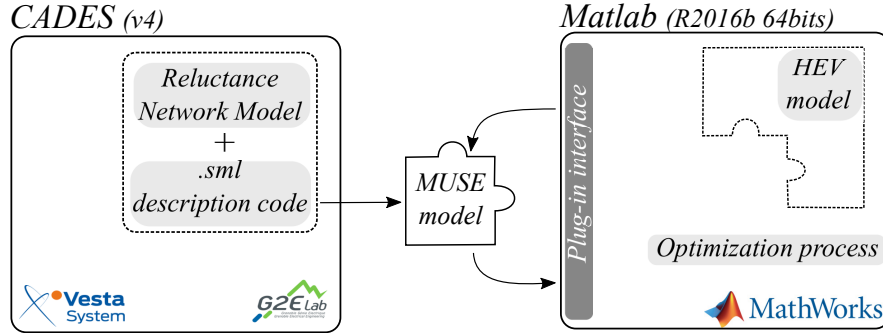

Figure 13: Implementation of the MUSE model embedding the RNM.

sumption of the HEV from the energy management and the speed imposed to the wheels by the driving cycle. In addition to the detailed EM model, the vehicle model has 5 more inputs ( $X_{HEV}$ ). These are the most important variables to describe such a vehicle:

- $N_{bat}$ , the number of battery modules (1.05 kW and 52.5 Wh per module);
- $U_{bus}$ , the DC voltage of the static converter (V);
- $P_{mt}$ , the internal combustion engine (ICE) power (W);
- $k_{cpl}$ , the coupling ratio;
- $k_{red}$ , the final gear ratio.

To sum up, 16 variables are used to describe the HEV, including 11 dedicated to a geometrical design of the EM and 5 other defining the remaining system components.

The HEV model contains the models of all the components of the parallel architecture, which is presented in Fig. 1:

- an analytical model is used for the batteries;
- a classical circuit model is used for the static converter. Pulse width modulation, IGBT and diode losses (conduction and switching) are considered;

- an analytical model with constant yield is used for the mechanical transmission;
- an efficiency map is used to represent the ICE;
- a classical model of the vehicle considering the drag force and the rolling resistance is used.

Note that both the ICE and the vehicle models have been validated through the experimental test bench at IFSTTAR [24, 25].

### 3.3. Computing performances

Table 2 presents some elements concerning the computing effort for the optimization process. The computation time considering one value of the pole number is presented by the last column. It also shows the gain enabled by the use of the RNM instead of the FEM. It is currently 3 times faster to build the efficiency map thanks to the RNM (4.4 s) than to call the FEM a single time (12 s).

Table 2: Comparison of solving times.

Model used	Type of computation		
	single call	efficiency map	optimization process
FEM	12 s		
RNM (2 poles)	.018 s	10.8 s	15 h
RNM (1 pole)	.009 s	4.4 s	5 h

These results are obtained on a same personal computer (i7-4710MQ @ 2,50 GHz processor, 16 GB RAM, Windows 7 Pro, 64 bits) using parallel computing. These values do not include the computation time to mesh the geometry in the finite element case.



## 4. Results

### 4.1. Fuel Consumption

This method has been applied on a parallel HEV architecture, following an urban Hyzem driving cycle [12]. Global optimization results (pareto fronts) are presented in Fig. 14. Each axis represents an objective (number of batteries vs fuel consumption) and each point corresponds to an optimal solution. The colour matches to the pole number of the EM.

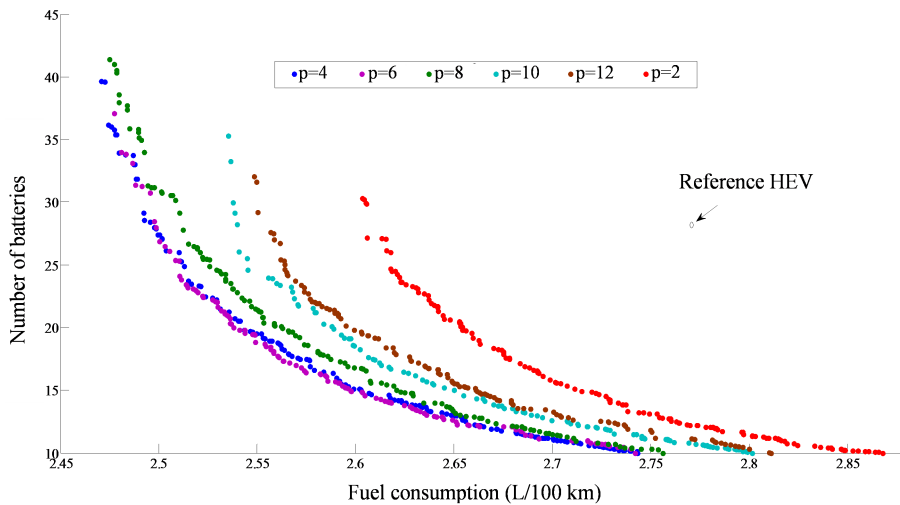

Figure 14: Comparison of pareto fronts for each number of poles.

First of all, an impact of the optimization is observed. The optimal HEV with an 8-pole EM consumes 9% less than the reference<sup>4</sup> HEV. Moreover the 4-pole EM and 6-pole EM lead to the best HEV systems reducing by about 1% the previous result. Fuel consumption increases in the other pole number cases but it remains an improvement compared to the reference HEV. Table 3 gives an

---

<sup>4</sup>The reference HEV is built from a conventional vehicle which is hybridized by the addition of a parallel electrical power-train, inspired from Toyota Prius 2004 data. A scaling factor was applied to the prius EM, and the coupling gear ratio were chosen arbitrarily. It is not an optimized sizing.

overview of optimal systems containing 28 battery modules (i.e. about 1.47 kWh, which is the reference HEV value), depending on the EM pole number.

Table 3: Overview of optimal systems containing 28 battery modules.

EM pole number	2	4	6	8	10	12
EM power-to-weight ratio [kW/kg]	1.6	1.42	1.04	0.85	0.64	0.69
ACM <sup>5</sup> traction efficiency at use [%]	82	87	87	87	87	86
ACM recovery efficiency at use [%]	85	89	89	89	88	88
Coupling gear ratio	1.92	1.29	0.7	0.59	0.4	0.4
Fuel consumption [l/km]	2.62	2.5	2.5	2.52	2.54	2.56

The best performances are notably due to an increase of the EM efficiency over the driving cycle. This reduces the energy needed to cover one kilometre. However, the consumption differences are small because the other HEV variables (as the coupling ratio) can change to match the optimal efficiency area of the EM. This is illustrated in Table 4 as well, which shows the speed of the EM for different speeds of the HEV.

Table 4: EM rotation speed at specific points of the driving cycle.

Pole number	EM rotation speed [rpm]		
	<i>HEV speed =</i>		
	<i>57 km/h</i>	<i>33 km/h</i>	<i>13 km/h</i>
2	3656	3327	2379
4	2524	2297	1643
6	1302	1185	847
8	1154	1051	751
10	753	686	490
12	750	683	488

<sup>5</sup>ACM is the French acronym for the combination of the static converter and the EM.

#### 4.2. EM sizing

An interesting result concerns the mass and the volume of the resulting EM with regards to the pole number. As shown in Fig. 15, in the case of systems containing 28 battery modules, it seems that the EM mass (as well as its volume) is reduced in systems with an EM composed of a low number of poles. The quantities of iron and copper also follow this trend. Note that the mass of end windings is taken into account.

In fact, the optimization converges on strictly different EM geometries if the number of poles is under 6 or above 8. In the system approach, fewer poles imply deep machines with a small diameter, and reciprocally, which confirms the result presented in [26].

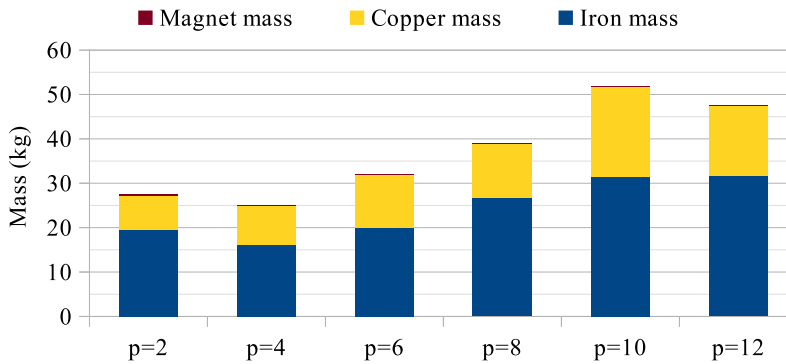

Figure 15: EM masses in optimal systems with 28 batteries.

## 5. Conclusion

In the paper, the influence of the EM pole number on optimal HEV systems is analysed using a global system sizing approach. The EM model gives a good approximation of the average torque. The pole number has a small influence on the system energy efficiency. The optimizations converge to different kinds of machines, in terms of geometry and dimensions. Smallest and lightest EM are

found in the case of a global optimization on a HEV with 4-pole or 6-pole EM. These two cases lead to the lowest fuel consumptions during the urban driving cycle as well.

The approach is using a software component (MUSE standard) as the EM model. It is embedding a fast reluctance network model designed in Cades-Reluctool. The use of the specific anti-periodicity component allows to reduce the model to a single pole. The resulting RNM is much faster than a FEM and more than twice faster than the 2-poles model, which was initially used.

Future works will focus on other architectures of HEV with two EM. The influence of the process on the design of the machines will be analysed.

## 6. Acknowledgements

The authors would like to thank the VESTA SYSTEM and the ALTAIR companies for their help.

## 7. References

- [1] n. W. Eurostat, Greenhouse gas emission statistics.
- [2] E. Silvas, E. Bergshoeff, T. Hofman, M. Steinbuch, Comparison of bi-level optimization frameworks for sizing and control of a hybrid electric vehicle, in: Vehicle Power and Propulsion Conference (VPPC), 2014 IEEE, 2014, pp. 1–6. doi:10.1109/VPPC.2014.7007029.
- [3] V. Reinbold, E. Vinot, L. Garbuio, L. Gerbaud, Optimal sizing of an electrical machine using a magnetic circuit model: application to a hybrid electrical vehicle, IET Electrical Systems in Transportation 6 (1) (2016) 27–33.
- [4] A. S. Mohammadi, J. P. Trovão, M. R. Dubois, Hybridisation ratio for hybrid excitation synchronous motors in electric vehicles with enhanced performance, IET Electrical Systems in Transportation 8 (1) (2018) p. 12–19. doi:DOI: 10.1049/iet-est.2017.0029.

- [5] E. Silvas, T. Hofman, N. Murgovski, L. P. Etman, M. Steinbuch, Review of optimization strategies for system-level design in hybrid electric vehicles, *IEEE Transactions on Vehicular Technology* 66 (1) (2017) 57–70.
- [6] Y. Zou, F. Sun, X. Hu, L. Guzzella, H. Peng, Combined optimal sizing and control for a hybrid tracked vehicle, *Energies* 5 (11) (2012) 4697–4710.
- [7] T. J. Boehme, B. Frank, M. Schori, T. Jeansch, Multi-objective optimal powertrain design of parallel hybrid vehicles with respect to fuel consumption and driving performance, in: *Control Conference (ECC), 2014 European*, IEEE, 2014, pp. 1017–1023.
- [8] C. Desai, S. S. Williamson, Optimal design of a parallel hybrid electric vehicle using multi-objective genetic algorithms, in: *Vehicle Power and Propulsion Conference, 2009. VPPC'09. IEEE, IEEE, 2009*, pp. 871–876.
- [9] T. Nuesch, T. Ott, S. Ebbesen, L. Guzzella, Cost and fuel-optimal selection of hev topologies using particle swarm optimization and dynamic programming, in: *American Control Conference (ACC), 2012, IEEE, 2012*, pp. 1302–1307.
- [10] B. Delinchant, D. Duret, L. Estrabaut, L. Gerbaud, H. Nguyen Huu, B. Du Peloux, H. L. Rakotoarison, F. Verdière, F. Wurtz, An optimizer using the software component paradigm for the optimization of engineering systems, *COMPEL-The international journal for computation and mathematics in electrical and electronic engineering* 26 (2) (2007) 368–379.
- [11] <http://muse-component.org/>.
- [12] M. André, Driving patterns analysis and driving cycles, within the project: European development of hybrid technology approaching efficient zero emission mobility (hyzem), INRETS report, n LEN 9709 (1997) 47.
- [13] A. Seshadri, A fast elitist multiobjective genetic algorithm: Nsga-ii, *MATLAB Central* 182.

- [14] R. Bellman, Dynamic programming and lagrange multipliers, Proceedings of the National Academy of Sciences of the United States of America 42 (10) (1956) 1–767.
- [15] J. Hsu, C. Ayers, C. Coomer, Report on toyota/prius motor design and manufacturing assessment, Federal Register (2004) 1–15.
- [16] E. Vinot, R. Trigui, B. Jeanneret, J. Scordia, F. Badin, Hevs comparison and components sizing using dynamic programming, in: Vehicle Power and Propulsion Conference, IEEE, 2007, pp. 314–321.
- [17] B. Du Peloux De Saint Romain, L. Gerbaud, F. Wurtz, E. Morin, A method and a tool for fast transient simulation of electromechanical devices: application to linear actuators, in: MOMAG 2010, Vila Vehla, Brazil, 2010.
- [18] W. H. Press, Numerical recipes 3rd edition: The art of scientific computing, Cambridge university press, 2007.
- [19] X. H. Nguyen, H. Dogan, L. Gerbaud, L. Garbuio, F. Wurtz, Efficient approach for angular modelling of electrical machine by reluctance network, in: Compumag 2013, 2013.
- [20] R. H. Staunton, C. W. Ayers, L. Marlino, J. Chiasson, B. Burrell, Evaluation of 2004 toyota prius hybrid electric drive system, Tech. rep., Oak Ridge National Lab.(ORNL), Oak Ridge, TN (United States) (2006).
- [21] E. Vinot, J. Scordia, R. Trigui, B. Jeanneret, F. Badin, Model simulation, validation and case study of the 2004 ths of toyota prius, International Journal of Vehicle Systems Modelling and Testing 3 (3) (2008) 139–167.
- [22] S. Robert, B. Delinchant, B. Hilaire, Y. Tanguy, Plumes: Towards a unified approach to building physical modeling, Proceedings of Building Simulation 2013.
- [23] <http://fmi-standard.org/>.

- [24] V. Reinbold, E. Vinot, L. Gerbaud, Global optimization of a parallel hybrid vehicle using optimal energy management, *International Journal of Applied Electromagnetics and Mechanics* 43 (1-2) (2013) pp-115.
- [25] R. Trigui, B. Jeanneret, B. Malaquin, C. Plasse, Performance comparison of three storage systems for mild hevs using phil simulation, *IEEE Transactions on Vehicular Technology* 58 (8) (2009) 3959–3969.
- [26] B. Multon, L. Hirsinger, Problème de la motorisation d’un véhicule électrique, 1ère partie, *revue 3EI* (1995) 1–53.