



HAL
open science

MS, CPW and Fin-line attenuation and dispersion effects on microwave and millimeter wave PBG structure parameters

J. Duchamp, A.-L. Perrier, Philippe Ferrari

► **To cite this version:**

J. Duchamp, A.-L. Perrier, Philippe Ferrari. MS, CPW and Fin-line attenuation and dispersion effects on microwave and millimeter wave PBG structure parameters. European Microwave Conference, Oct 2004, Amsterdam, France. hal-01816047

HAL Id: hal-01816047

<https://hal.science/hal-01816047>

Submitted on 18 Jun 2018

HAL is a multi-disciplinary open access archive for the deposit and dissemination of scientific research documents, whether they are published or not. The documents may come from teaching and research institutions in France or abroad, or from public or private research centers.

L'archive ouverte pluridisciplinaire **HAL**, est destinée au dépôt et à la diffusion de documents scientifiques de niveau recherche, publiés ou non, émanant des établissements d'enseignement et de recherche français ou étrangers, des laboratoires publics ou privés.

MS, CPW and Fin-line attenuation and dispersion effects on microwave and millimeter wave PBG structure parameters

J.M. Duchamp, A.L. Perrier, P. Ferrari

University of Savoy, LAHC, Domaine universitaire, 73376 Le Bourget du lac, France, (+33) 479758686

Abstract — This paper presents a simple analytical method to describe both effects of linear transmission line losses and, for the first time, frequency dispersion on photonic band-gap (PBG) propagation parameters. Applied to a coplanar waveguide PBG structure, this approach points out the attenuation difference between the two frequently used electrical models : one with fully distributed parameters and one with semi distributed parameters. Moreover, a comparison of the same PBG design with three technologies of transmission lines (CPW, MS and Fin-line) gives very interesting results on the Bragg frequency value and the PBG attenuation.

I. INTRODUCTION

Recently, the microwave and millimeter wave domains have shown a great interest in photonic band-gap (PBG) structures. PBG are periodical structures enhancing pass-bands and stop-bands in the frequency response which are interesting for filters [1]-[2] or non linear transmission line (NLTL) [3]-[4] designs. PBG can be realized easily with transmission lines periodically loaded with shunt-connected reactive elements (PL-PBG).

The propagation constant and the characteristic impedance of PL-PBG have already been studied [5] but no analytical method of losses study is yet available. Two types of electrical losses models are available : distributed ones and lumped ones. For example, coplanar wave-guide (CPW) dielectric ($\alpha_{L,d}$) and radiative ($\alpha_{L,r}$) losses, are described by distributed models in [6]-[7], while Heinrich in [8] prefers to model CPW conductor losses ($\alpha_{L,c}$) with a lumped element : a series resistor.

This paper, for the first time to our knowledge, describes the effects of the losses and dispersion of the transmission line on PL-PBG structures. Firstly the two electrical models are introduced by the transfer matrix method frequently used and PL-PBG propagation parameter equations are extracted. Then losses results obtained on a on a CPW periodical structure, from the two models (a fully distributed one and a semi distributed one) are compared. The last part points out the effect of dispersion on PL-PBG parameters by comparing the same PL-PBG designs with three different kinds of linear transmission line: Microstrip (MS), Coplanar Wave-guide (CPW) and Fin-line.

II. LOSSES MODELS

Thanks to Floquet's theorem, only one section (length d) of the periodical structure needs to be studied if the structure can be assumed as an infinite one.

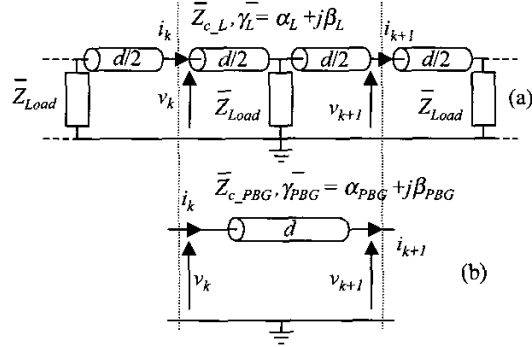

Fig. 1 Periodical loaded structure with fully distributed parameters (a) and an electrical model of one equivalent section (b).

Complex propagation parameters of one PL-PBG section (Fig. 1) are obtained from ABCD matrix :

$$\begin{bmatrix} v_k \\ i_k \end{bmatrix} = e^{\bar{\gamma}_{PBG} \cdot d} \begin{bmatrix} v_{k+1} \\ i_{k+1} \end{bmatrix} = \begin{bmatrix} \bar{A} & \bar{B} \\ \bar{C} & \bar{D} \end{bmatrix} \begin{bmatrix} v_{k+1} \\ i_{k+1} \end{bmatrix} \quad (1)$$

The PBG attenuation, propagation constant and characteristic impedance are defined by :

$$\cosh(\alpha_{PBG} + j\beta_{PBG}) = \frac{1}{2}(\bar{A} + \bar{D}) = \bar{A} \quad (2)$$

$$\bar{Z}_{c,PBG} = \Re_e(\bar{Z}_{c,PBG}) + j\Im_m(\bar{Z}_{c,PBG}) = \sqrt{\bar{B}/\bar{C}} \quad (3)$$

A. Fully Distributed Model

By identification between one PBG section (Fig. 1-a) and the fully distributed parameter model (Fig. 1-b), real and imaginary parts of (2) give these two equations :

$$\begin{aligned} \Re_e(\bar{A}) &= \cosh(\alpha_{PBG} \cdot d) \cos(\beta_{PBG} \cdot d) \\ &= \cosh(\alpha_L \cdot d) \left(\cos(\beta_L \cdot d) - \frac{1}{2} Z_{c,L} Y_{Load} \sin(\beta_L \cdot d) \right) \end{aligned} \quad (4)$$

$$\begin{aligned}\Im_m(\bar{A}) &= \sinh(\alpha_{PBG} \cdot d) \sin(\beta_{PBG} \cdot d) \\ &= \sinh(\alpha_L \cdot d) \left(\sin(\beta_L \cdot d) + \frac{1}{2} Z_{c_L} Y_{Load} \cos(\beta_L \cdot d) \right) \quad (5)\end{aligned}$$

In the case of a loss-less transmission line (α_L equal to $\alpha_{L_c} + \alpha_{L_d} + \alpha_{L_r}$), equation $\Re_e(\bar{A})$ becomes equal to (6). It still being true if linear losses are small, the first order Taylor formula of $\Re_e(\bar{A})$ and $\Im_m(\bar{A})$, lead to these two equations :

$$\cos(\beta_{PBG} \cdot d) = \cos(\beta_L \cdot d) - \frac{1}{2} Z_{c_L} Y_{Load} \sin(\beta_L \cdot d) \quad (6)$$

$$\alpha_{PBG} = \frac{\alpha_L \left(\sin(\beta_L \cdot d) + \frac{1}{2} Z_{c_L} Y_{Load} \cos(\beta_L \cdot d) \right)}{\sqrt{1 - \left(\cos(\beta_L \cdot d) - \frac{1}{2} Z_{c_L} Y_{Load} \sin(\beta_L \cdot d) \right)^2}} \quad (7)$$

The various Bragg frequencies $f_{B,i}$ are obtained from relation (6) when $\cos(\beta_{PBG} \cdot d) = -1$. We notice that Bragg frequencies are not modified by small losses (no α_L dependency).

A lumped approximation of $f_{B,i}$ (8) is used to define the section length d .

$$f_{B,i} = \left(c_0 \cdot Z_{c_PBG} \right) / \left(\pi \cdot \sqrt{\epsilon_{r_eff}} \cdot Z_{c_L} \cdot d \right) \quad (8)$$

The PBG attenuation α_{PBG} is given by relation (7). Two characteristic limits of α_{PBG} are pointed out :

$$\lim_{f \rightarrow 0} (\alpha_{PBG}) = \alpha_L \quad (9)$$

$$\lim_{f \rightarrow f_{B,i}} (\alpha_{PBG}) = +\infty \quad (10)$$

At low frequency, PL-PBG losses are equal to linear transmission line losses and at Bragg frequencies, when propagation is forbidden, equivalent PBG losses become infinite.

B. Semi Distributed Model

The second model has the propagation parameter β_L distributed (instead of lumped when LC parameters are used) and losses are described by two lumped resistors (Fig. 2).

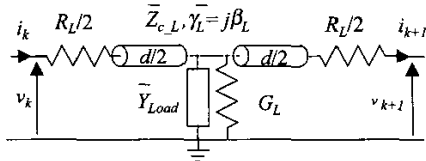

Fig. 2 Semi-distributed electrical model of one section

As previously, identification of Fig. 1-b, with Fig. 2, in the case of low losses gives two new equations (11) for $\Re_e(\bar{A})$ and (12) for $\Im_m(\bar{A})$:

$$\begin{aligned}\cos(\beta_{PBG} \cdot d) &= \frac{1}{4} G_L R_L \\ &+ \left(1 + \frac{1}{4} G_L R_L \right) \cos(\beta_L \cdot d) - \frac{1}{2} Z_{c_L} Y_{Load} \sin(\beta_L \cdot d) \quad (11)\end{aligned}$$

$$\alpha_{PBG} = \frac{R_L}{Z_{c_L} \cdot d} \cdot \frac{\cos\left(\beta_L \cdot \frac{d}{2}\right)}{\sqrt{1 - \cos(\beta_{PBG} \cdot d)^2}} \quad (12)$$

$$\left(1 + \frac{G_L}{R_L} Z_{c_L}^2 \sin\left(\beta_L \cdot \frac{d}{2}\right) + \frac{1}{2} Z_{c_L} Y_{Load} \cos\left(\beta_L \cdot \frac{d}{2}\right) \right)$$

Relations between losses elements in Fig. 2 and parameters of Fig. 1-a are :

$$R_L = 2d\alpha_{r_L} Z_{c_L} \quad (13)$$

$$G_L = 2d(\alpha_{d_L} + \alpha_{r_L}) / Z_{c_L} \quad (14)$$

C. CPW Model Comparison

In this part, modelling results of an example structure will be given. A CPW transmission line periodically loaded by capacitances, illustrates the differences of these two approaches.

CPW transmission line is printed on a GaAs substrate with $Z_{c_L} = 120 \Omega$ @ 60 GHz (Fig. 3) and capacitance loads C_L are chosen to achieve $Z_{c_PBG} = 50 \Omega$ (15). [6-8] models are used to describe CPW losses and frequency dispersion parameters.

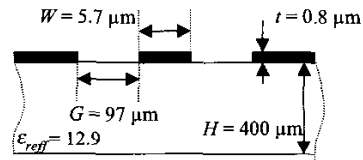

Fig. 3 CPW geometrical and substrate parameters.

From relation (3) and for loss-less PBG structure, characteristic impedance is only real until the frequency reaches the Bragg value (in pass-band frequency range). At $f_{B,i}$, Z_{c_PBG} is null. Then above $f_{B,i}$ (in stop-band frequency ranges) Z_{c_PBG} becomes purely imaginary.

When the line is lossy, characteristic impedance Z_{c_PBG} is a complex value and $\overline{|Z_{c_PBG}|} > 0 \forall f$.

At low frequency, a large signal equivalent impedance can be defined by

$$\lim_{f \rightarrow 0} (Z_{c_PBG}) = Z_{c_ls} = \frac{Z_{c_L}}{\sqrt{1 + \frac{C_{ls} \cdot c_0 \cdot Z_{c_L}}{d \cdot \sqrt{\epsilon_{r_eff}}}}} \quad (15)$$

Fig. 4 shows $\Re_e\left(\overline{|Z_{c_PBG}|}\right)$ versus normalized frequency $f / f_{B,i}$ for the fully distributed model and the semi distributed one.

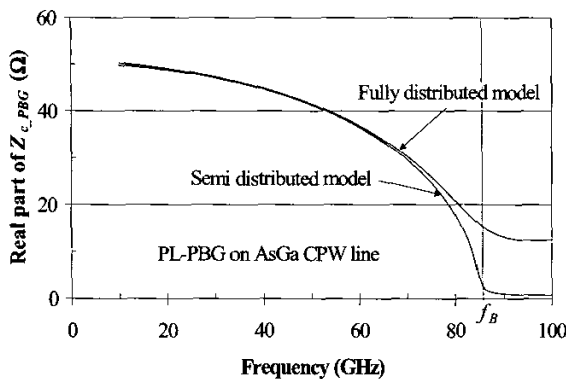

Fig. 4 Real part of characteristic impedance versus frequency for fully distributed models and semi distributed models for the CPW example.

Models give equivalent results until 80% of $f_{B,1}$. The frequency varies from 10 GHz to 100 GHz. Fig. 5 compares the PBG attenuation $\alpha_{PBG}(f)$ and the real part of characteristic impedance versus the frequency for these two models. We also add CPW attenuation $\alpha_L(f)$. Near the Bragg frequency $f_{B,1}$ (85 GHz for $d = 189 \mu\text{m}$), the two α_{PBG} models raise quickly (10). Although at low frequencies the semi-lumped model does not reach the expected limit: α_L .

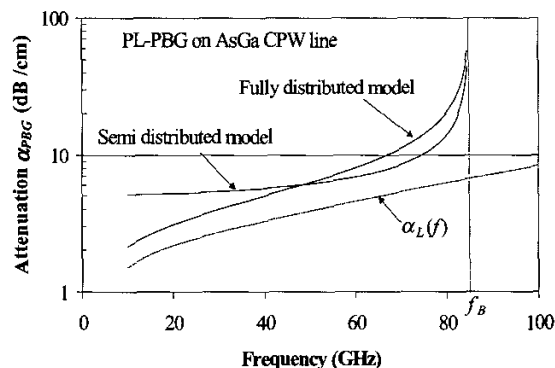

Fig. 5 Attenuation versus frequency for the fully distributed and semi distributed models for the CPW example.

III. LINEAR TRANSMISSION LINES DISPERSION

MS and CPW transmission line have been extensively studied. In this paper, we complete the study by adding Fin-line one. MS and CPW are designed on the same GaAs substrate. Geometrical parameters for CPW and MS are given on Fig. 6-a. The unilateral Fin-line, based on WR-42 guide, is described Fig. 6-b.

Fin-line propagation parameter equations are given in [9]-[10]. $Z_{c,L}$ is adapted with the ratio e/b . These three lines are designed for the same characteristic impedance value $Z_{c,L} = 120 \Omega$ and for the first band stop frequency $f_{B,1}$ is equal to 80 GHz. For MS and Fin-line, section lengths d are respectively equal to $152 \mu\text{m}$ and $508 \mu\text{m}$. Other parameters of (8) are defined at 20 GHz.

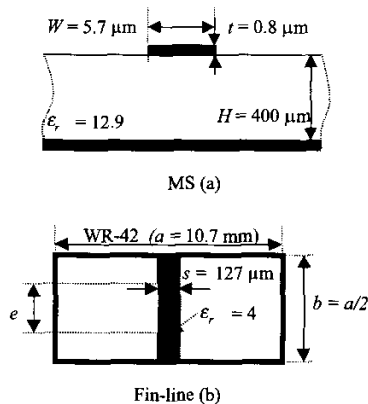

Fig. 6 MS and Fin-line geometrical and substrate parameters.

A fully distributed electrical model has been used to describe each PBG section and the capacitance loads are calculated to achieve $Z_{c,PBG} = 50 \Omega$.

Simulation results shown on Fig. 7 and Fig. 8 point out the effect of linear line dispersion.

It confirms that lumped propagation model (LC model) for Bragg frequency gives an underestimated $f_{B,1}$ value. In our example, the first Bragg frequency of CPW PBG structure, which is a low frequency disperse structure (less than 1% on the frequency range) is equal to 85 GHz instead of 80 GHz given by (8).

For frequency disperse lines, like MS or Fin-line, the $f_{B,1}$ value is reduced by the variation of the propagation parameters. In our example MS line exhibits a first Bragg frequency at 74.5 GHz and for the Fin-line, this value is 68.8 GHz as it is shown on Fig. 8.

Despite a larger dispersion for Fin-line than CPW, real parts of $Z_{c,PBG}$ stay quite close for frequencies lower than 50 GHz.

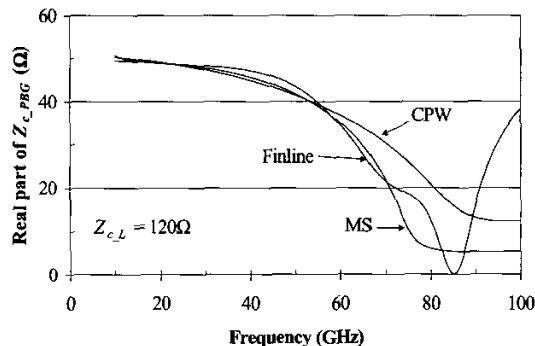

Fig. 7 Real part of the impedance characteristic of one PBG section for MS, CPW, Fin-line transmission lines.

Fig. 8 shows PBG attenuation of one PBG section versus frequency. MS and CPW line have the highest attenuation and still close on all the frequency range. However the most interesting results are about the fin-line attenuation which exhibits the periodical minimum values at $f_{min,1} = 28.5 \text{ GHz}$ and at $2f_{min,1} = 57 \text{ GHz}$.

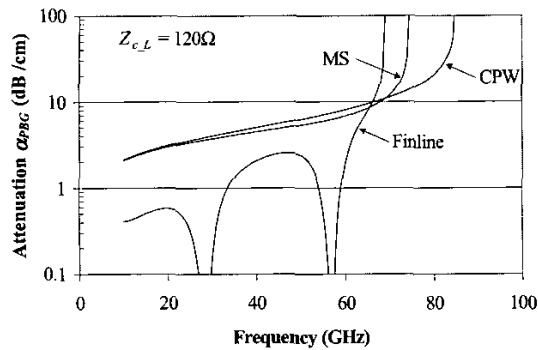

Fig. 8 PBG attenuation of one PBG section for MS, CPW, Fin-line transmission lines.

IV. CONCLUSIONS

In this paper, we describe a new and simple method to take into account all losses, including radiative ones, and the frequency parameters dispersion in PL-PBG structures. A fully distributed approach seems the most accurate one and our measures will confirm it soon. Furthermore a really interesting result is drawn out when we compare the transmission line dispersion effects. A PL-PBG based on Fin-line exhibits periodically low losses at f_{min} and $k.f_{min}$. This result can be used to design, for example, NLTTL frequency multipliers in which the pump and generated frequencies are adjusted to reach the minimum attenuation at $k.f_{min}$.

REFERENCES

[1] T. Y. Yun, and K. Chang, "Uniplanar One-Dimensional Photonic-Bandgap Structures and Resonators", *IEEE Transactions on Microwave Theory and Techniques*, Vol. 49, no. 3, pp. 549-553, March 2001.

[2] J. Sor, Y. Qian, and T. Itoh, "Miniature Low-Loss CPW Periodic Structures for Filter Applications", *IEEE Transactions on Microwave Theory and Techniques*, Vol. 49, No. 12, pp. 2336-2341, December 2001.

[3] J.-M. Duchamp, P. Ferrari, M. Fernandez, A. Jrad, X. Melique, Junwu Tao; S. Arscott, D. Lippens, and R.G. Harrison, "Comparison of Fully Distributed and Periodically Loaded Nonlinear Transmission Lines", *IEEE Transactions on Microwave Theory and Techniques*, Vol. 51, no. 4, pp. 1105-1116, April 2003.

[4] S. Hollung, J. Stake, L. Dillner, M. Ingvarson, and E. L. Kollberg, "A Distributed Heterostructure Barrier Varactor Frequency Tripler", *IEEE Microwave and Guided Wave Letters*, Vol. 10, No. 1, pp. 24-26, Jan. 2000.

[5] Lei Zhu, "Guided-wave characteristics of periodic coplanar waveguides with inductive loading-unit-length transmission parameters", *IEEE Transactions on Microwave Theory and Techniques*, Vol. 51, no. 10, pp. 2133-2138, October 2003.

[6] R. N. Simons, *Coplanar Waveguide Circuits, Components and Systems*, Wiley & Sons, Inc., 2001.

[7] M. Y. Frankel, S. Gupta, J. A. Valdmanis, and G. A. Mourou, "Terahertz Attenuation and Dispersion Characteristics of Coplanar Transmission Lines", *IEEE Transactions on Microwave Theory and Techniques*, Vol. 39, no. 6, pp. 910-916, June 1991.

[8] W. Heinrich, "Quasi-TEM Description of MMIC Coplanar Lines Including Conductor-Loss Effects", *IEEE Transactions on Microwave Theory and Techniques*, Vol. 41, no. 1, pp. 45-52, January 1993.

[9] D. Mirshekar-Syahkal, and J. B. Davies, "Accurate Analysis of Coupled Strip-Fineline Structure for Phase Constant, Characteristic Impedance, Dielectric and Conductor Losses", *IEEE Transactions on Microwave Theory and Techniques*, Vol. 82, no. 6, pp. 906-910, June 1982.

[10] A. K. Sharma, and W. J. R. Hoefer, "Empirical Expressions for Fin-Line Design", *IEEE Transactions on Microwave Theory and Techniques*, Vol. 83, no. 4, pp. 350-356, April 1983.