



HAL
open science

Targeting Well-Balanced Solutions in Multi-Objective Bayesian Optimization under a Restricted Budget

David Gaudrie, Rodolphe Le Riche, Victor Picheny, Benoît Enaux, Vincent Herbert

► **To cite this version:**

David Gaudrie, Rodolphe Le Riche, Victor Picheny, Benoît Enaux, Vincent Herbert. Targeting Well-Balanced Solutions in Multi-Objective Bayesian Optimization under a Restricted Budget. Journées du GdR Mascot-Num 2018, Mar 2018, Nantes, France. hal-01803844

HAL Id: hal-01803844

<https://hal.science/hal-01803844>

Submitted on 31 May 2018

HAL is a multi-disciplinary open access archive for the deposit and dissemination of scientific research documents, whether they are published or not. The documents may come from teaching and research institutions in France or abroad, or from public or private research centers.

L'archive ouverte pluridisciplinaire **HAL**, est destinée au dépôt et à la diffusion de documents scientifiques de niveau recherche, publiés ou non, émanant des établissements d'enseignement et de recherche français ou étrangers, des laboratoires publics ou privés.

Targeting Well-Balanced Solutions in Multi-Objective Bayesian Optimization under a Restricted Budget

David Gaudrie^{1,2,3}, Rodolphe le Riche², Victor Picheny³, Benoît Enaux¹, Vincent Herbert¹

¹Groupe PSA, ²CNRS, Mines Saint-Étienne, ³MIAT, Université de Toulouse, INRA



Industrial context

Multi-objective optimization of high dimensional systems (d up to 40)

$$\min_{\mathbf{x} \in X \subset \mathbb{R}^d} (f_1(\mathbf{x}), \dots, f_m(\mathbf{x}))$$

Computationally expensive CFD codes (24 hours per simulation) \Rightarrow optimization under restricted budget \Rightarrow metamodel-based optimization: Multi-Objective EGO [1]

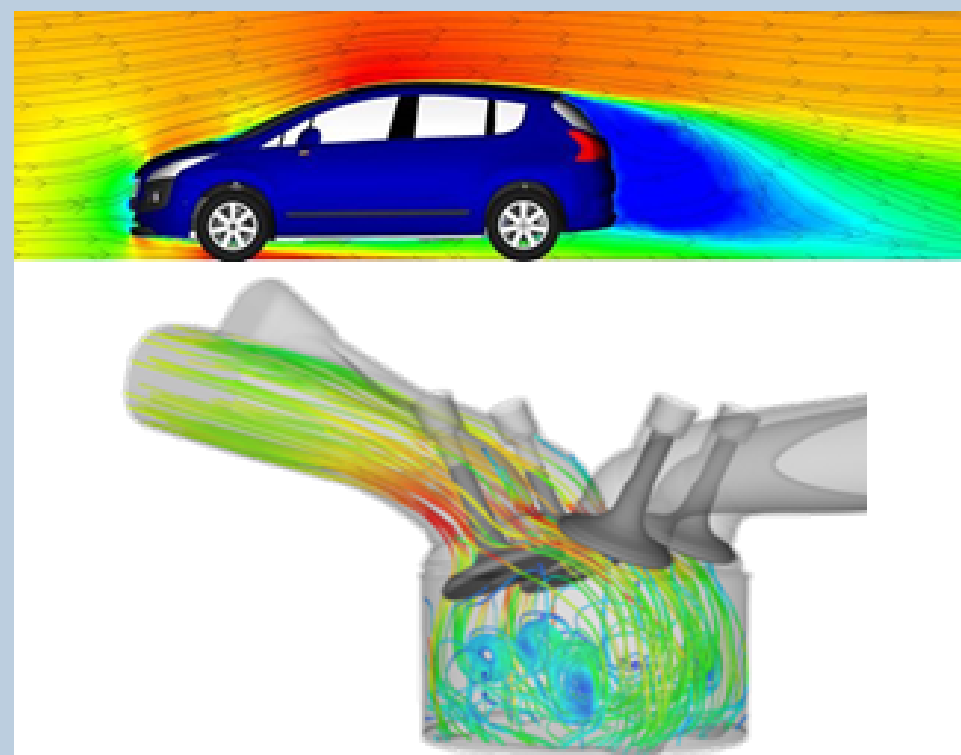

Multi-criteria decision-aid: choice among the optimal solutions made by a Decision Maker

Very tiny budget (≈ 100 evaluations), many objectives ($m \approx 6-8$) \Rightarrow impossible for classical MO-EGO approaches to uncover the Pareto Front (growing size of \mathcal{P}_Y with m)

How to obtain several optimal trade-off solutions in spite of the extremely parsimonious use of the computer code, and the multiple conflicting objectives?

Targeting: motivations

- Restricted budget and large number of objectives \Rightarrow Uncovering the whole Pareto Front \mathcal{P}_Y in a "region of interest"
- Shrink search to a smaller subset \Rightarrow faster convergence
- Emphasize solutions that *equilibrate* the objectives: (unknown) central part of the Pareto Front (PF) \Rightarrow interesting solutions for Decision Makers

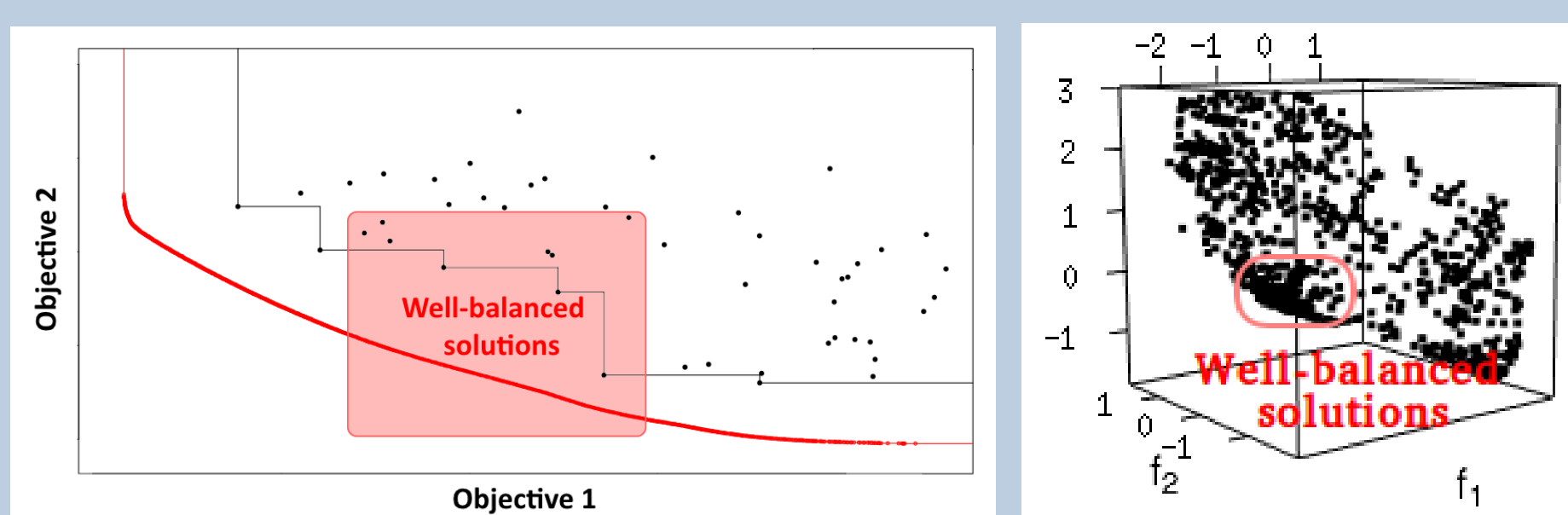

Center of the Pareto Front

Center \mathbf{C} = Projection of closest non-dominated point on Ideal-Nadir line \mathcal{L}

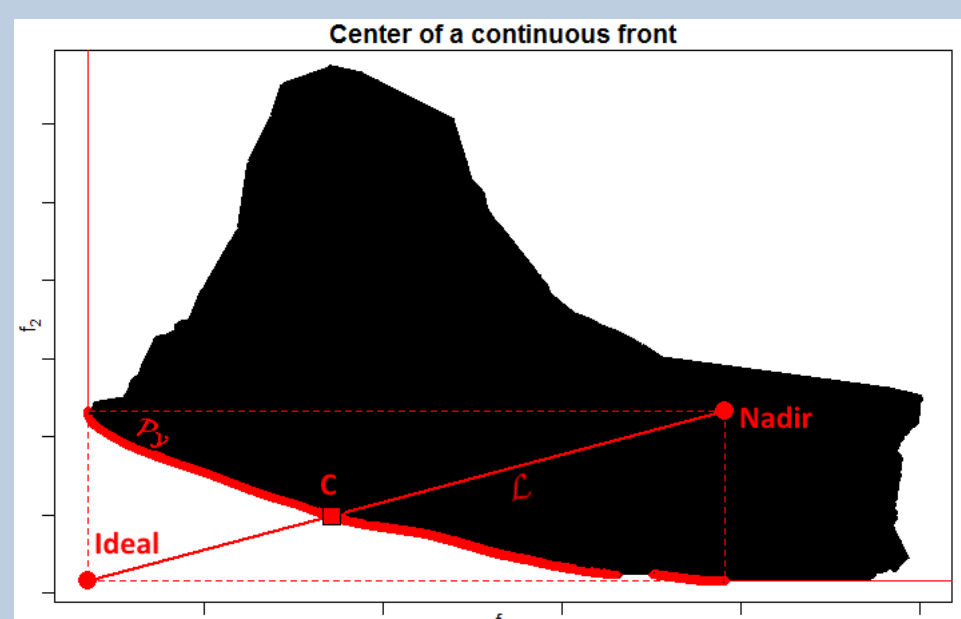

- Low dependence to variations of \mathbf{I} and \mathbf{N} : $|\frac{\partial C_i}{\partial I_i}|$ and $|\frac{\partial C_i}{\partial N_i}| < 1$ for a continuous front
- Insensitive to a linear scaling of the objectives in a bi-objective case, and when \mathcal{L} intersects \mathcal{P}_Y
- Computationally cheap, even for large m
- Estimation: GP simulations emphasizing the edges of the PF \Rightarrow estimated Ideal, Nadir and $\hat{\mathcal{L}} \Rightarrow$ estimated center $\hat{\mathbf{C}}$

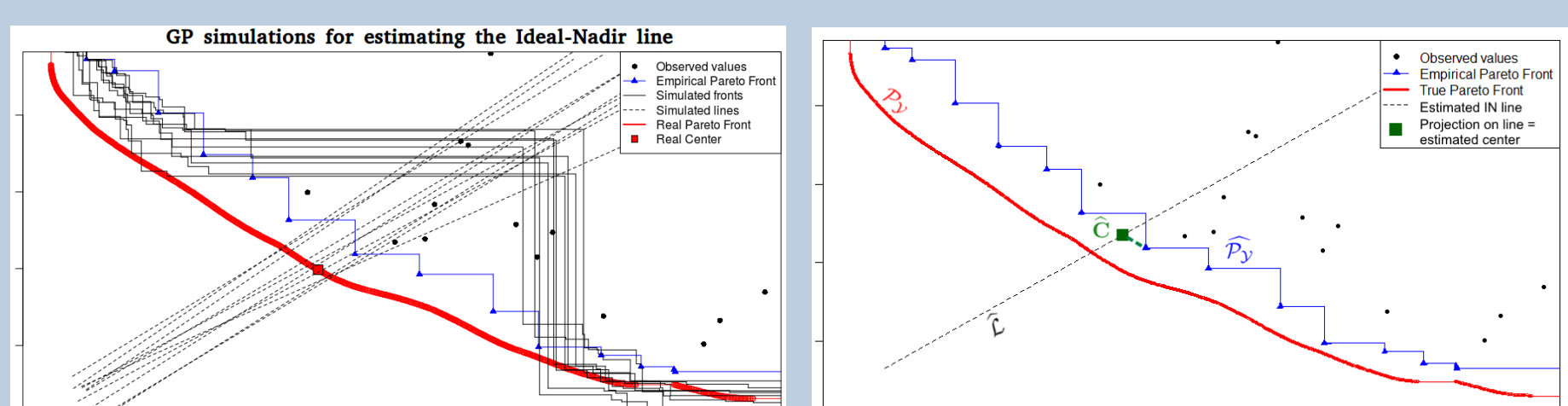

Infill Criteria for targeting the center

$IC = f(Y_1(\cdot), \dots, Y_m(\cdot); \mathbf{x}; \Theta)$: directs the search towards attractive new designs \mathbf{x}^*

Modify existing IC through Θ to direct the search towards the estimated central area

- Hypervolume Indicator [2]: $H(\hat{\mathcal{P}}_Y; \mathbf{R}) = \Lambda \left(\bigcup_{\mathbf{y} \in \hat{\mathcal{P}}_Y} \{\mathbf{z} : \mathbf{y} \preceq \mathbf{z} \preceq \mathbf{R}\} \right)$
- EHI: Expected Improvement of the Hypervolume Indicator [3] (relatively to \mathbf{R}), if adding design \mathbf{x}

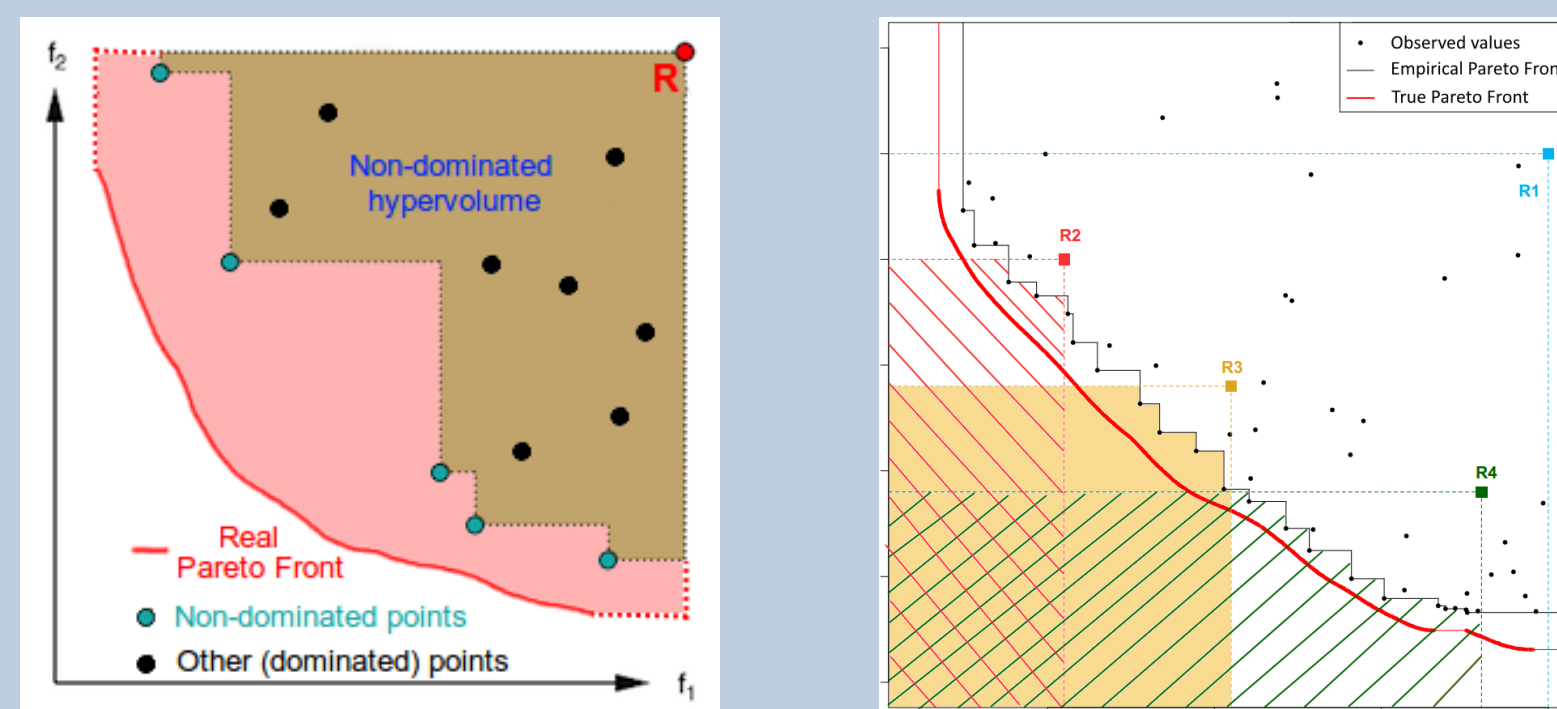

- Subspace targeted by \mathbf{R} : $\mathcal{I}_{\mathbf{R}} = \{\mathbf{y} \in \mathbb{R}^m : \mathbf{y} \preceq \mathbf{R}\}$
- Product of Expected Improvement w.r.t. $\hat{\mathbf{C}}$: $mEI(\mathbf{x}; \hat{\mathbf{C}}) = \prod_{i=1}^m EI_i(\mathbf{x}; \hat{C}_i)$, $EI_i(\cdot, \hat{C}_i)$: EI in objective i considering \hat{C}_i as the current minimum
- If $\mathbf{R} \notin \hat{\mathcal{P}}_Y$, $EHI(\cdot; \mathbf{R}) = mEI(\cdot; \mathbf{R})$

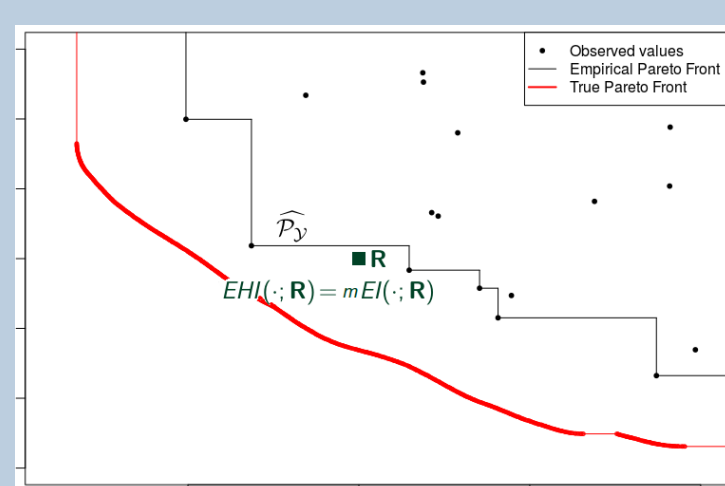

- Still cheap for large m
- Analytical expression
- Parallelizable

Use the estimated center $\hat{\mathbf{C}}$ as reference point \mathbf{R} \Rightarrow Optimization directed towards the center

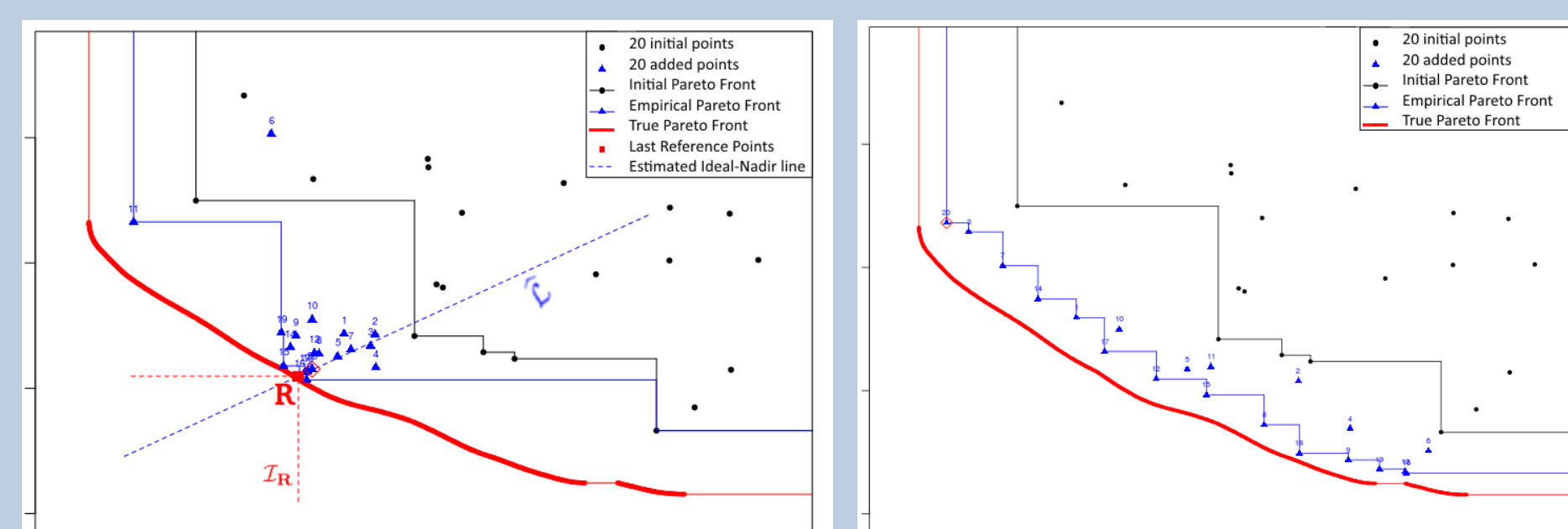

Convergence towards the center of the PF

When to stop the targeting of the center?

- Probability of domination $p(\mathbf{y})$: probability that objective vector \mathbf{y} can be dominated by any $(f_1(\mathbf{x}), \dots, f_m(\mathbf{x})), \mathbf{x} \in X$
- Estimated using Pareto Fronts from GP draws: $p(\mathbf{y}) = \frac{1}{n_{sim}} \sum_{i=1}^{n_{sim}} \mathbb{1}_{\hat{\mathcal{P}}_Y^{(i)} \preceq \mathbf{y}}$
- Information about (local) uncertainty and convergence towards the PF

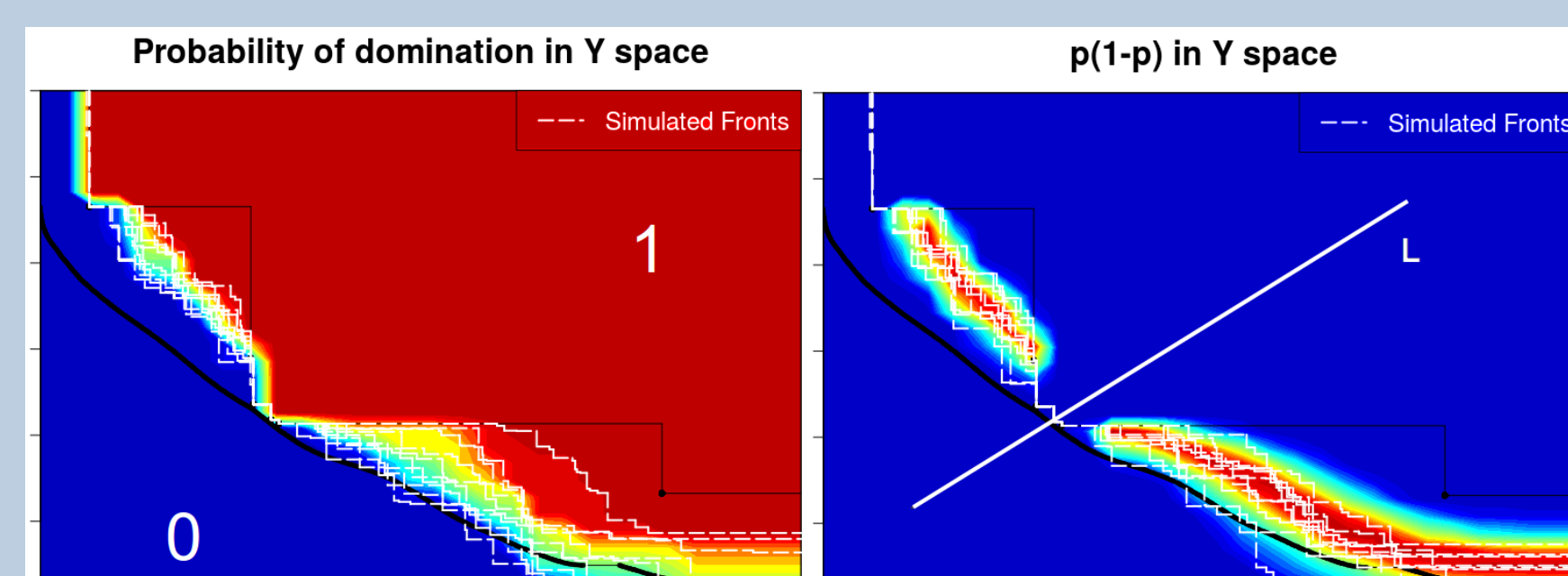

Assume local convergence towards the central part of the PF when $\int_{\hat{\mathcal{L}}} p(\mathbf{y})(1-p(\mathbf{y}))d\mathbf{y} \leq \varepsilon$

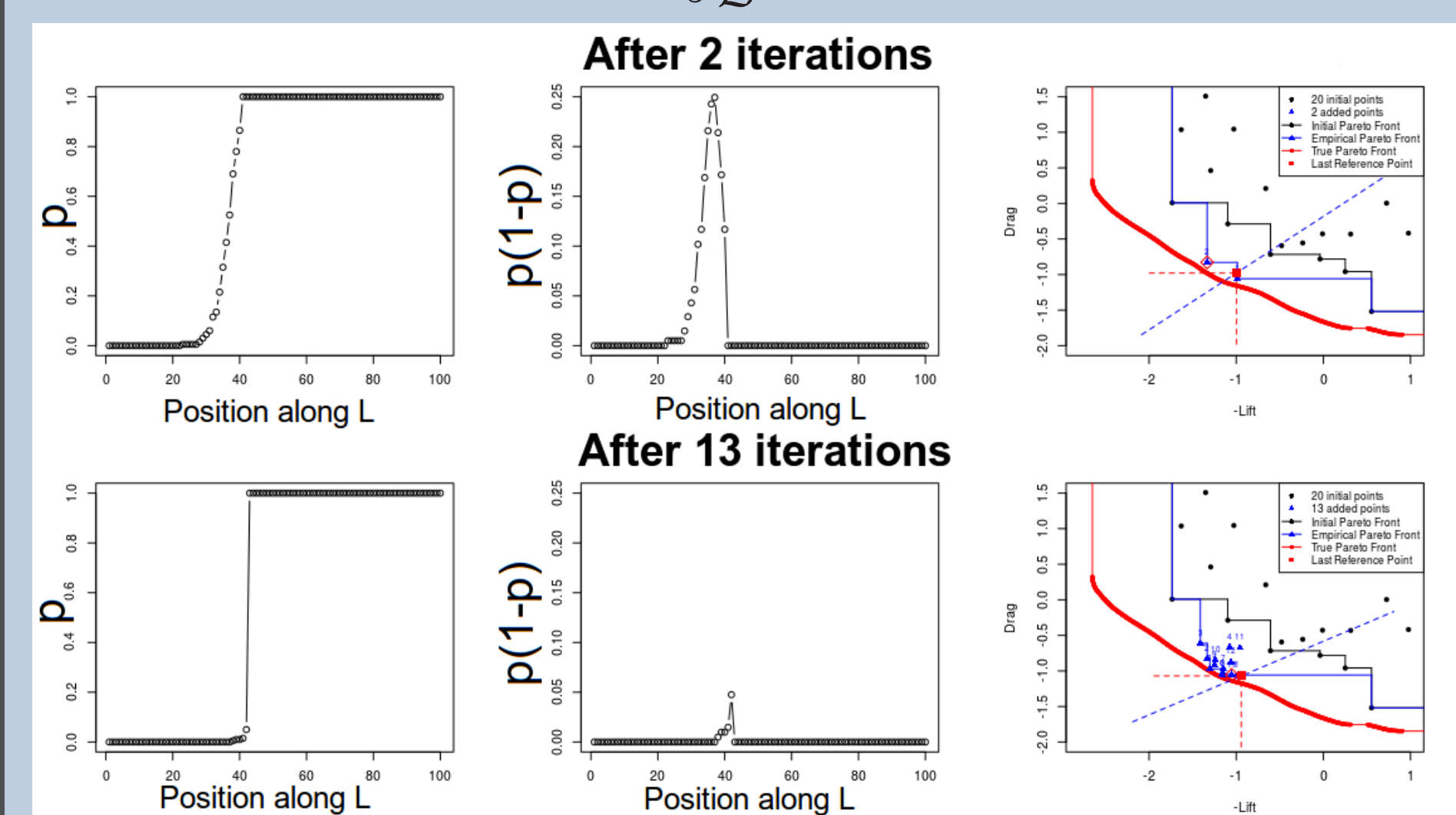

After local convergence: expansion of the PF

b iterations remaining \Rightarrow what to do next?

- Local convergence detected
- Use the remaining budget b to converge towards \mathcal{P}_Y in a wider but attainable central part
- $EHI(\cdot, \mathbf{R})$, with \mathbf{R} on $\hat{\mathcal{L}} \Rightarrow$ focus on central part of \mathcal{P}_Y , size of targeted subspace depending on distance between \mathcal{P}_Y and \mathbf{R}
- Anticipate the algorithm's behavior in the next iterations and the final PF via *virtual infills* that depend on \mathbf{R} : forecast the width of the PF that can be accurately discovered in the last b steps
- *Virtual infills*: either through a Kriging Believer strategy (anticipated \mathbf{y} 's are the kriging mean) or through GPs realizations (anticipated \mathbf{y} 's are samples)
- Small uncertainty on virtual final Pareto Front = convergence in $\mathcal{I}_{\mathbf{R}} \Rightarrow$ choose farthest \mathbf{R} such that $\frac{1}{Vol(\mathcal{I}_{\mathbf{R}})} \int_{\mathcal{I}_{\mathbf{R}}} p(\mathbf{y})(1-p(\mathbf{y}))d\mathbf{y} \leq \varepsilon$

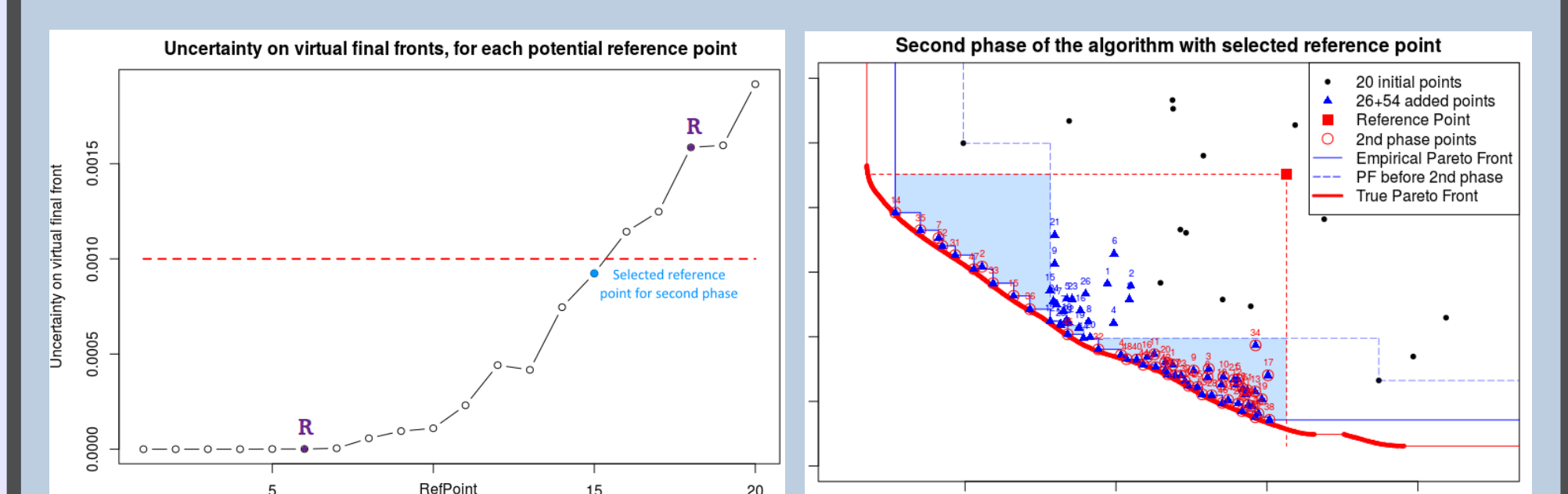
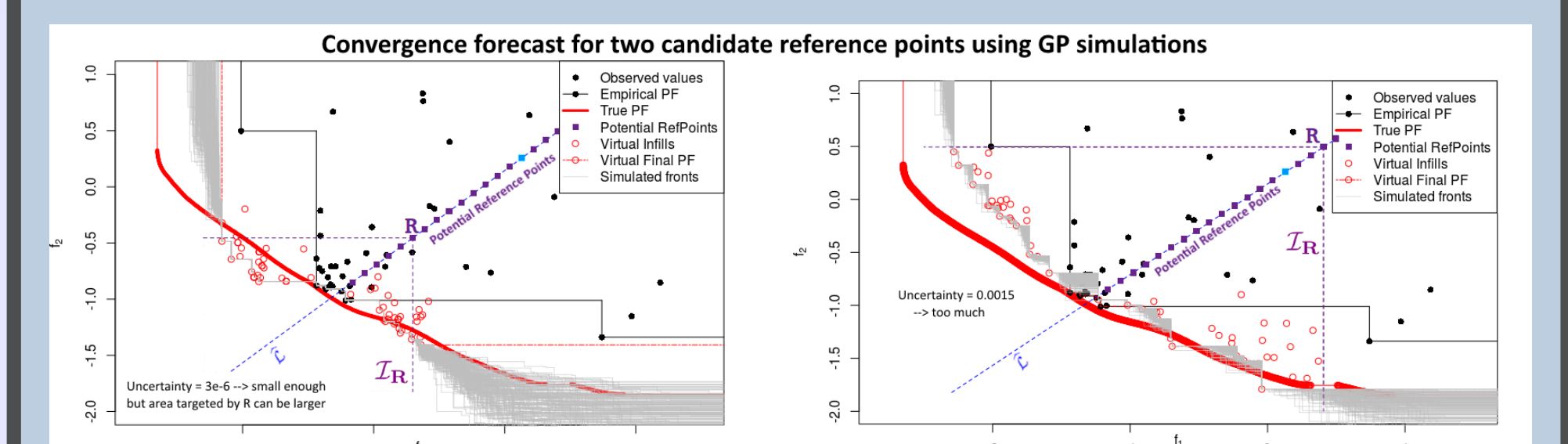

Summary

A two-step algorithm for targeting well-balanced solutions within a few iterations:

- Estimate the Ideal-Nadir line $\hat{\mathcal{L}}$, on which the expected center of the PF is located
- Define a reference point \mathbf{R} combining $\hat{\mathcal{L}}$ and the current approximation front $\hat{\mathcal{P}}_Y$
- Target the estimated central part of the PF using \mathbf{R} and a targeting infill criterion
- When convergence is detected, widen the region of interest $\mathcal{I}_{\mathbf{R}}$ by a backward step of \mathbf{R} calculated through virtual infills.

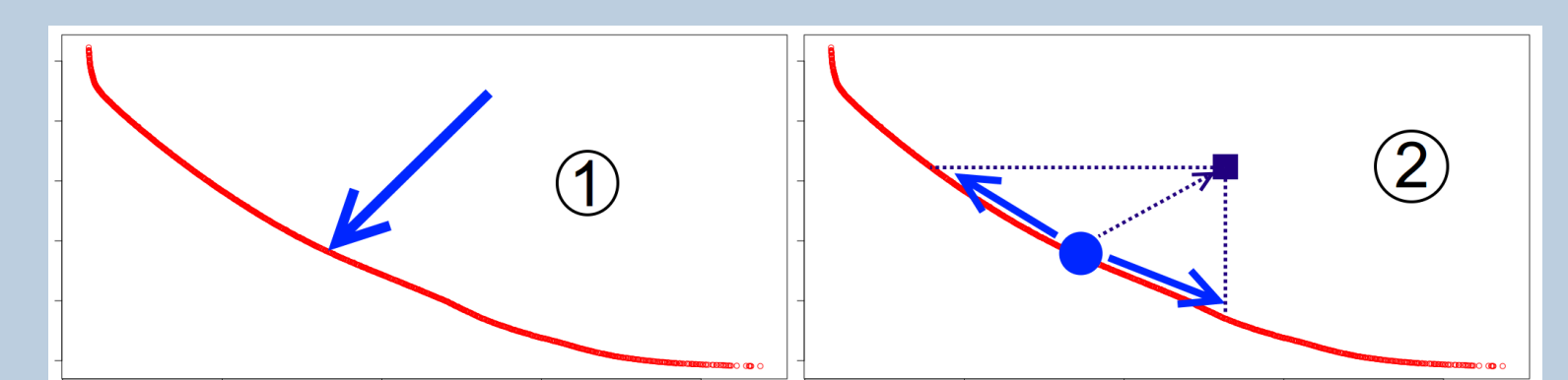

References

- [1] D. R. Jones, M. Schonlau, and W. J. Welch, Efficient global optimization of expensive black-box functions, *Journal of Global Optimization*, 13, 455–492 (1998)
- [2] E. Zitzler and L. Thiele, Multiobjective Optimization Using Evolutionary Algorithms - A Comparative Case Study, *Conference on Parallel Problem Solving from Nature (PPSN V)*, pages 292–301 (1998)
- [3] M. Emmerich, K. Giannakoglou, B. Naujoks, Single and Multiobjective Evolutionary Optimization Assisted by Gaussian Random Field Metamodels, *IEEE Transactions on Evolutionary Computation*, 10 (2006)