



2018 INTERNATIONAL SOCIETY
FOR ASPHALT PAVEMENTS

ISAP CONFERENCE

JUNE 19th – 21st, 2018 - HOTEL GRAN MARQUISE
FORTALEZA-CEARÁ-BRAZIL

2D Multilayer Analysis of Electrified Roads with Charging Box Discontinuities

Armelle Chabot and Pawan Deep

Materials and Structures Department



IFSTAR



2018 INTERNATIONAL SOCIETY
FOR ASPHALT PAVEMENTS
ISAP CONFERENCE
JUNE 19th – 21st, 2018 – HOTEL GRAN MARQUISE
FORTALEZA-CEARÁ-BRAZIL

Introduction

Context and background

In order to attain the reduction of CO₂ emissions under the objectives of European Energy Agency (EEA 2016), one of the solutions proposed being is the electrified Roads (eRoad)

→ Challenge for 2030!

Catenary



Conduction



Solar

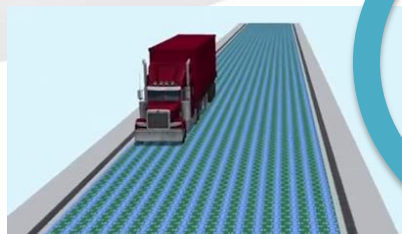

Induction



https://www.youtube.com/watch?v=BtaAp_wTr7E



Induction charging solution

Without any contact

Static

- Already tested (Nguyen et al., 2015)
(Pérez et al., MC2016) ...
- Almost ready for the future...



Dynamic / Main benefits for vehicles

- Time... no needs to park the EVs
- Smaller and lighter batteries (Seugmin et al., 2015)



Still Pb to solve from M&S pt of vue!



2018 INTERNATIONAL SOCIETY
FOR ASPHALT PAVEMENTS
ISAP CONFERENCE
JUNE 19th – 21st, 2018 – HOTEL GRAN MARQUISE
FORTALEZA-CEARÁ-BRAZIL

Outlines

- 1 Intro / Context
- 2 M&S pavement needs: asphalt tRoads → eRoads
- 3 M4-5nW developments for eRoad analysis
- 4 Results and 1 alternative M&S eRoad proposal
- 5 Conclusion & Prospects



2018 INTERNATIONAL SOCIETY FOR ASPHALT PAVEMENTS
ISAP CONFERENCE
JUNE 19th – 21st, 2018 – HOTEL GRAN MARQUISE
FORTALEZA – CEARÁ – BRAZIL

M&S pavement needs

Top layer problems

Box inclusion (CC material) in asphalt pavements

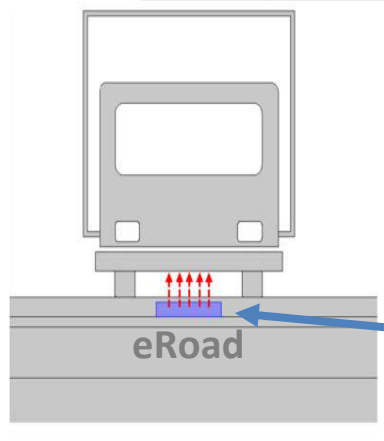

Charging Unit (CU) slab

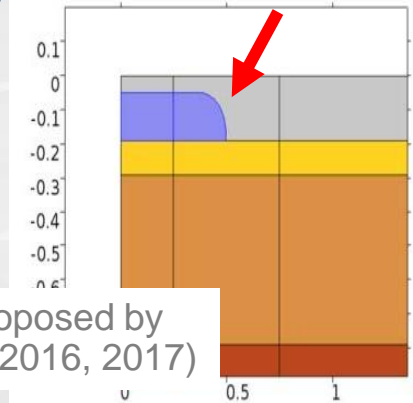
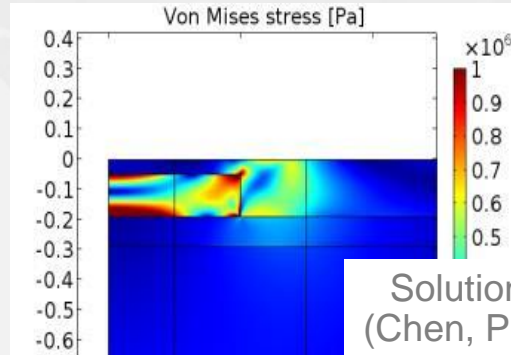

Solution proposed by (Chen, PHD 2016, 2017)

Lateral loads effects

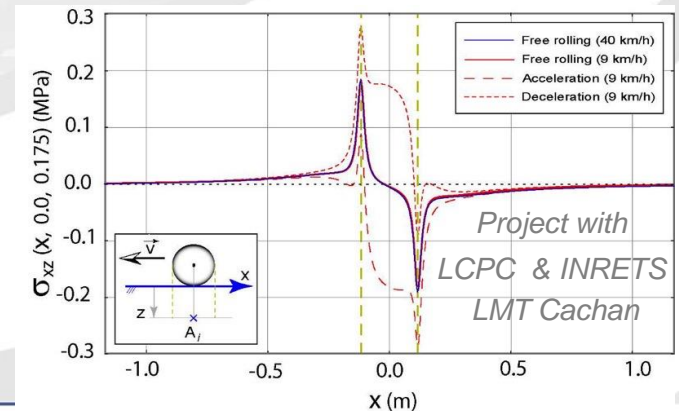

Hammoum F. et al., 2010. Accelerating and Decelerating Effects of Tramway Loads moving on Bituminous Pavement. *M&S*, 43:1257-1269



M&S pavement needs discontinuities...

Debonding (RILEM MCD2016, MCD STAR ChIII: Petit et al. 2018, Chen et al. 2018)

- $E_{\text{layer}}/E_{\text{CU}} \rightarrow (T^{\circ}\text{C}, \text{Load speed})$
- Boundary conditions

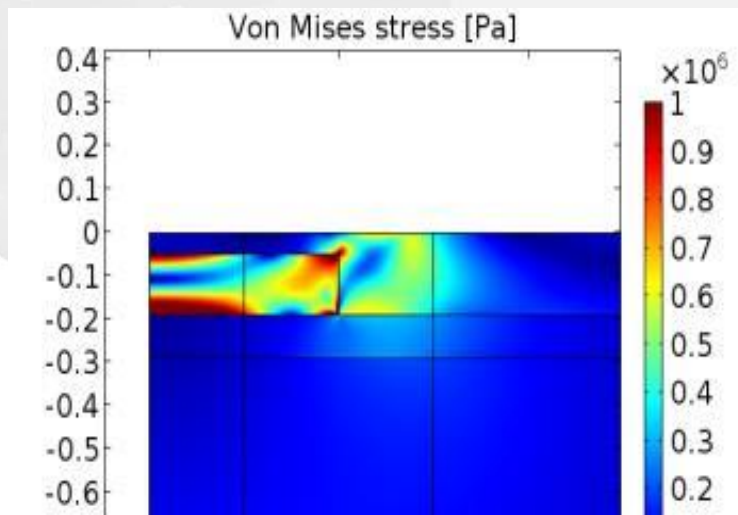

(Chen, PHD 2016, 2017)

Any cables somewhere?

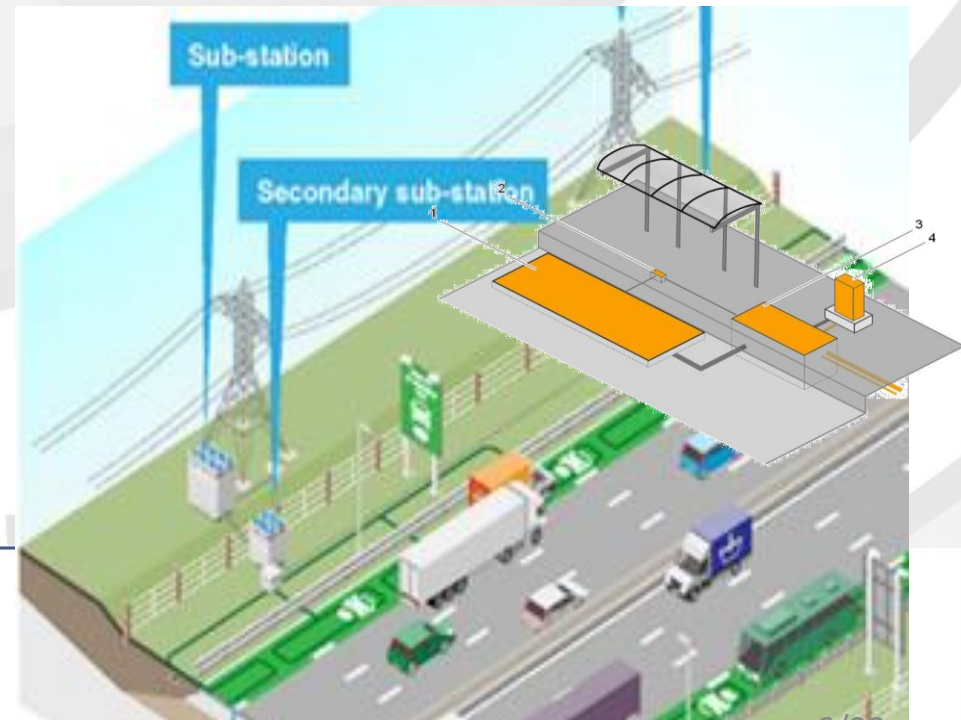



2018 INTERNATIONAL SOCIETY
FOR ASPHALT PAVEMENTS
ISAP CONFERENCE
JUNE 19th – 21st, 2018 – HOTEL GRAN MARQUISE
FORTALEZA-CEARÁ-BRAZIL

Outlines

- 1 Intro / Context
- 2 M&S pavement needs: asphalt tRoads → eRoads
- 3 M4-5nW developments for eRoad analysis
- 4 Results and 1 alternative M&S eRoad proposal
- 5 Conclusion & Prospects



Why?

Debonding criteria ?

2018 INTERNATIONAL SOCIETY FOR ASPHALT PAVEMENTS
ISAP CONFERENCE
 JUNE 19th – 21st, 2018 – HOTEL GRAN MARQUISE
 FORTALEZA-CEARÁ-BRAZIL

Interface stresses (2D strain plane)

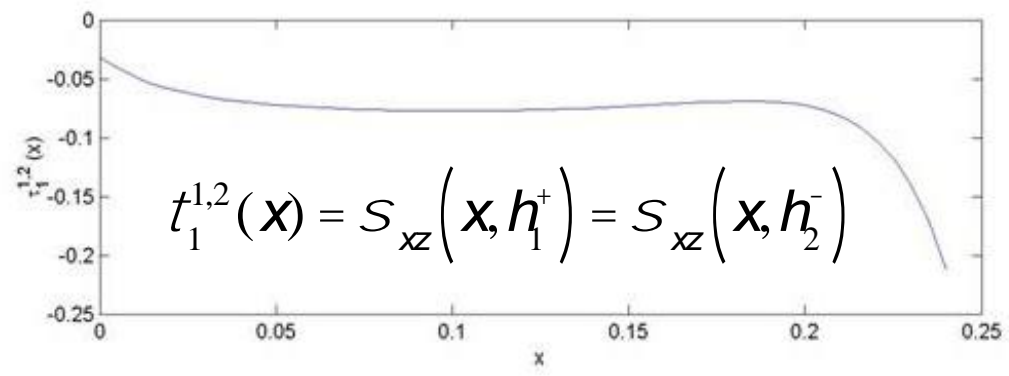
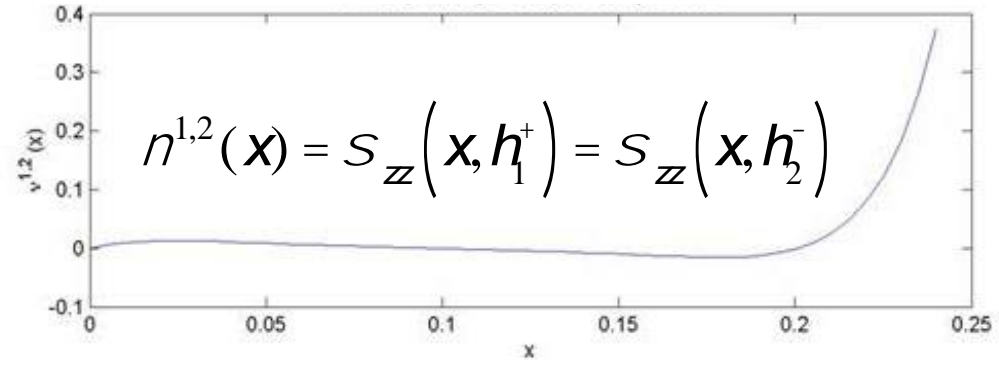



Why?

Debonding criteria ?



2018 INTERNATIONAL SOCIETY FOR ASPHALT PAVEMENTS
ISAP CONFERENCE
JUNE 19th - 21st, 2018 - HOTEL GRAN MARQUISE
FORTALEZA-CEARÁ-BRAZIL

For homogeneous material ok!

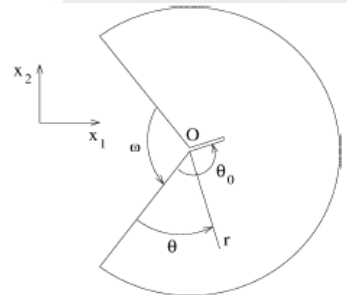

$$\bar{\sigma} = \frac{K_I}{\sqrt{r}} f_I(\theta) + \frac{K_{II}}{\sqrt{r}} f_{II}(\theta) + \dots \left\{ \begin{array}{l} G(\bar{\sigma}, \bar{u}) = - \frac{\partial E_p(\bar{\sigma}, \bar{u}, a)}{\partial a} \\ G < G_c \end{array} \right.$$

$$\underline{U}(x_1, x_2) = \underline{U}(O) + kr^\lambda \underline{u}(\theta) + \dots$$

The critical value k_c depends on the opening ω of the notch, it must be experimentally determined. The factors k and k_c are strongly dependent of the singularity and in particular of the exponent λ . Units for

For bi-material, it is worst, λ can be a complexe field

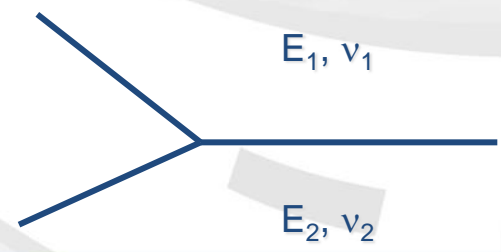

- Point stress?
- Average stress?
- Energy release rate -> fatigue...: Paris law?

Multi-particle Model of Multi-layer Materials (M4) – 5n

(Chabot, 1997)
(Chabot & Ehrlicher, 1998)

- Polynomial approximation per layer i in z for σ_{ij}
- Hellinger-Reissner formulation (Reissner, 1950)

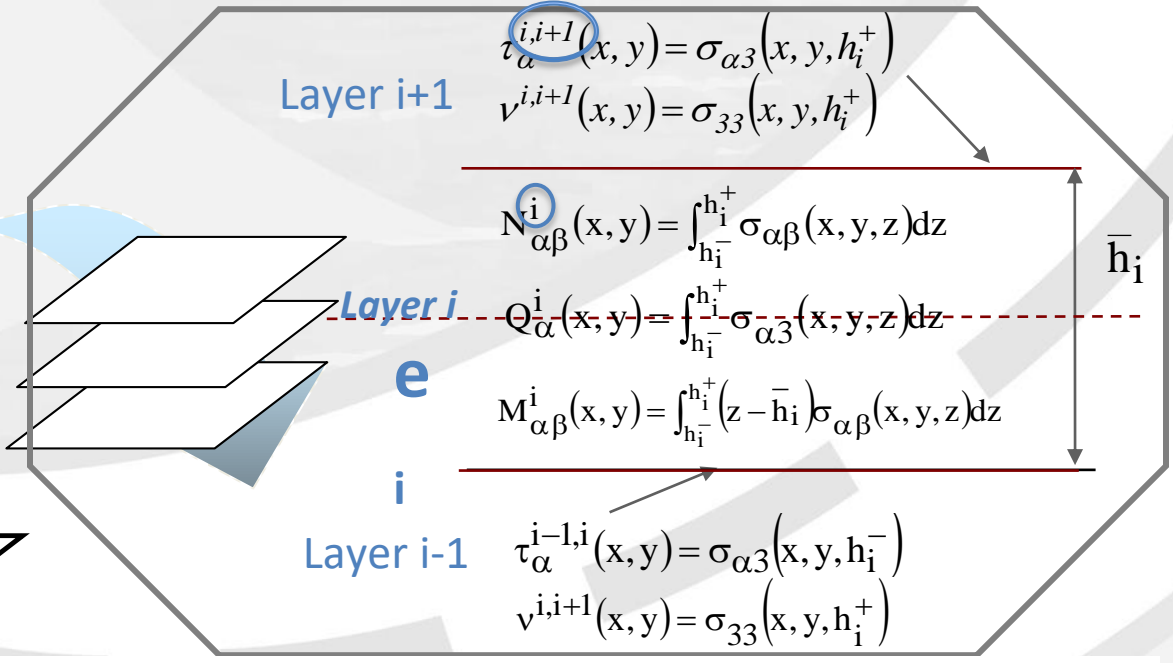
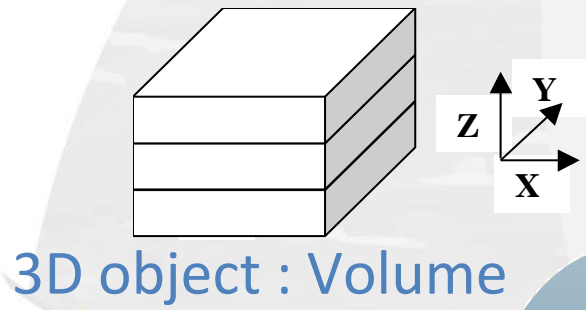

Chabot A., Ehrlicher A. 1998, *JNC11*, Arcachon, **3**, 1389-1397
For pavements (Tran et al., RILEM CP2004) (Chabot et al., BLPC2005) etc



M4-5nW 2D tool

(Nasser, PHD 2016) (Nasser and Chabot, 2018)

2D Problem → only 1D system to solve with matrix (12,12)

$$AX''(x) + BX'(x) + CX(x) = DY^{0,1'}(x) + EY^{n,n+1'}(x) + FY^{0,1}(x) + GY^{n,n+1}(x)$$

$$X = \begin{bmatrix} X^1 \\ X^2 \\ X^3 \\ X^4 \end{bmatrix}_{12 \times 1} \quad [X^i] = \begin{bmatrix} U_1^i \\ \phi_1^i \\ U_3^i \end{bmatrix} \quad [Y^{i,i+1}] = \begin{bmatrix} \tau_1^{i,i+1} \\ \nu^{i,i+1} \end{bmatrix}$$

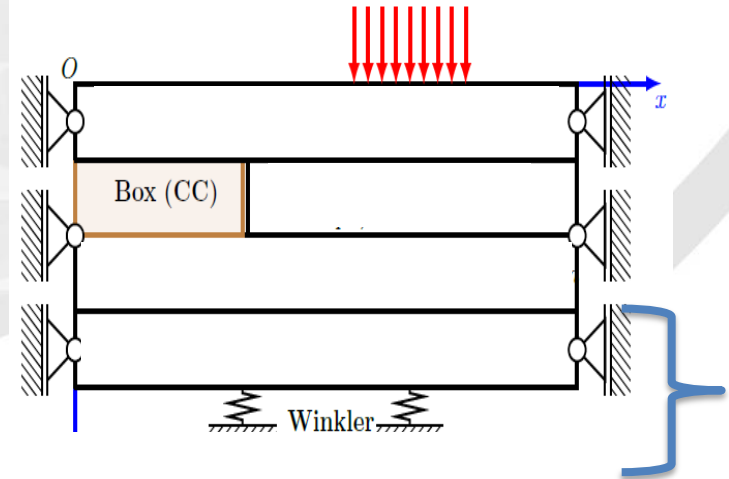

Numerically → Newmark method

$$\frac{X'_{j+1} + X'_j}{2} = \frac{X_{j+1} + X_j}{k_{j+1}}$$

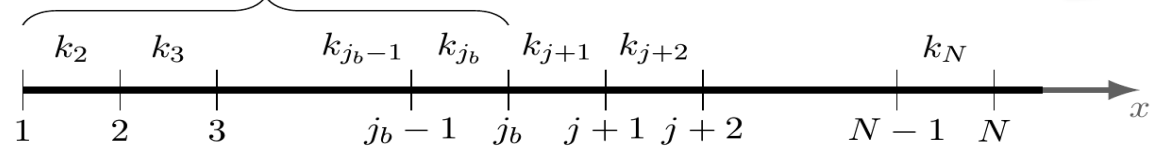

Nasser H., Chabot A., 2018. A Half-analytical Elastic Solution for 2D Analysis of Cracked Pavements. *Advances in Engineering Software*, 117: 107-122

$$U_1(x, z) = U_1^i(x) + (z - \bar{h}_i)\phi_1^i(x) + \Delta U_1^i(x)$$



Introducing the material discontinuity (Deep, 2017)

$$A^I X''(x) + B^I X'(x) + C^I X(x) = D^I Y^{0,1'}(x) + E + F^I Y^{0,1}(x) + G^I Y^{n,n+1}(x)$$

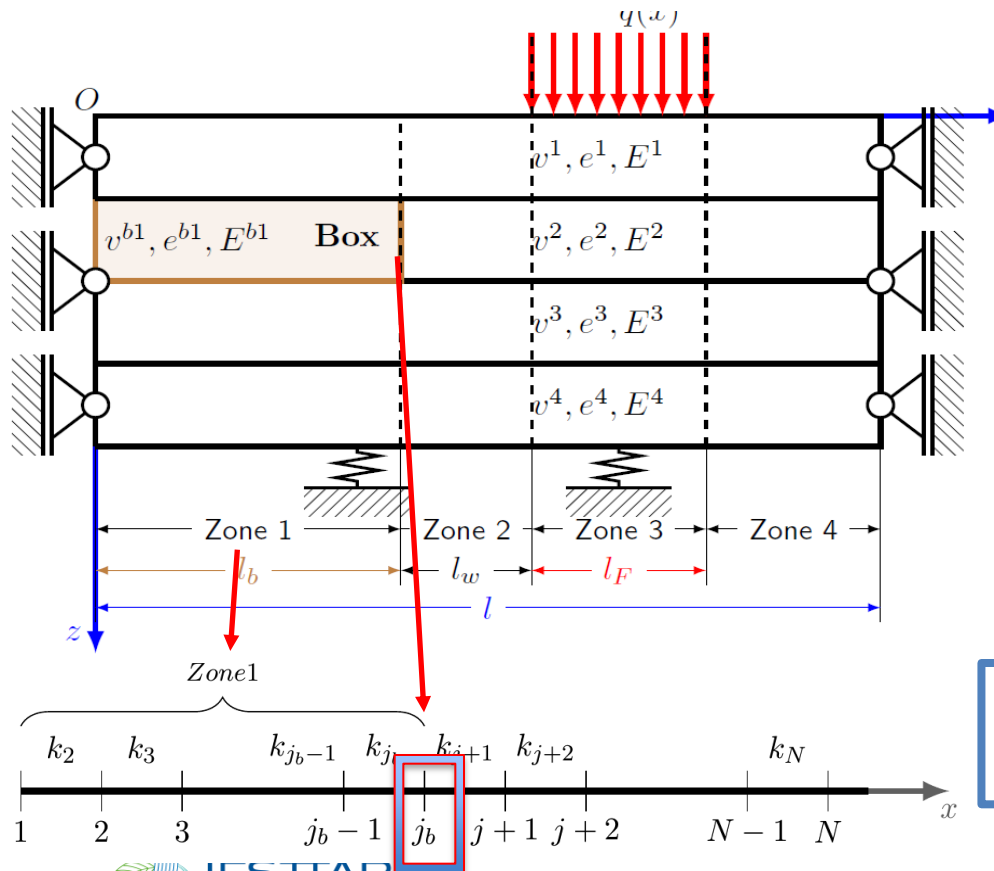

For zone with index I (CU)

1. Discretization posed issues as derivatives: in Newmark scheme used left and right nodes
2. All the matrices relating to zone 1 was to be modified in the code even before discretization, after discretization and for post processing

After discretization

$$AX(x) = BY^{0,1}(x) + CY^{n,n+1}(x) + D$$



Introducing material discontin. & 1 vertical crack

(Deep, 2017)

$$A^I X''(x) + B^I X'(x) + C^I X(x) = D^I Y^{0,1'}(x) + E^I Y^{n,n+1'}(x) + F^I Y^{0,1}(x) + G^I Y^{n,n+1}(x)$$

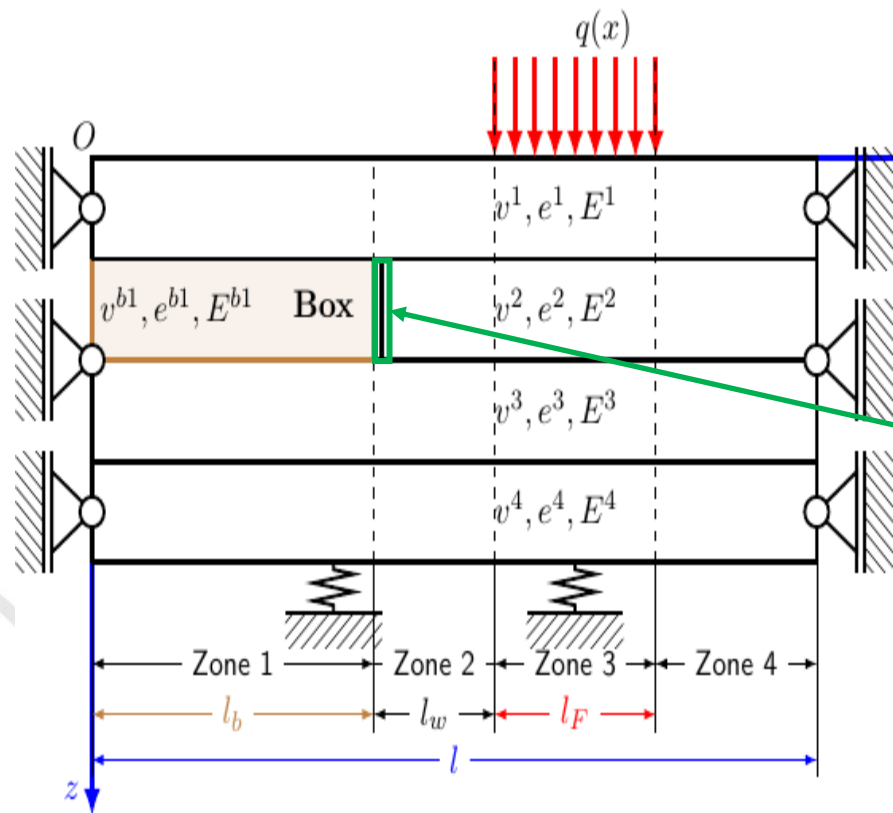

Crack discretization $X_f = X_{jb}$

Layer 2 stresses around this node are zero

$$\begin{cases} N_{11}^2(X_f) = 0 \\ M_{11}^2(X_f) = 0 \\ Q_1^2(X_f) = 0 \end{cases} \quad \text{et} \quad \begin{cases} N_{11}^2(X_{f+1}) = 0 \\ M_{11}^2(X_{f+1}) = 0 \\ Q_1^2(X_{f+1}) = 0 \end{cases}$$

For layer 2

→ Boundary condition on the left and right at the point of crack and so changes are made in the system

$$AX(x) = BY^{0,1}(x) + CY^{n,n+1}(x) + D$$



2018 INTERNATIONAL SOCIETY
FOR ASPHALT PAVEMENTS
ISAP CONFERENCE
JUNE 19th – 21st, 2018 – HOTEL GRAN MARQUISE
FORTALEZA-CEARÁ-BRAZIL

Outlines

- 1 Intro / Context
- 2 M&S pavement needs: asphalt tRoads → eRoads
- 3 M4-5nW developments for eRoad analysis
- 4 Results and 1 alternative M&S eRoad proposal
- 5 Conclusion & Prospects



2D comparison M4-5nW vs (Chen, 2016) for tRoad

$$w=0, E^1=1000\text{MPa} = E^2$$

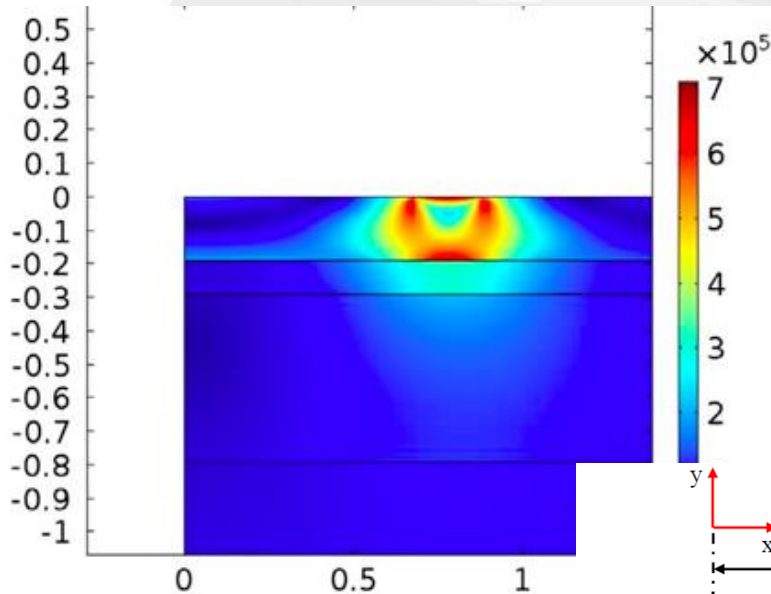

(Chen, 2016)(in Pa)

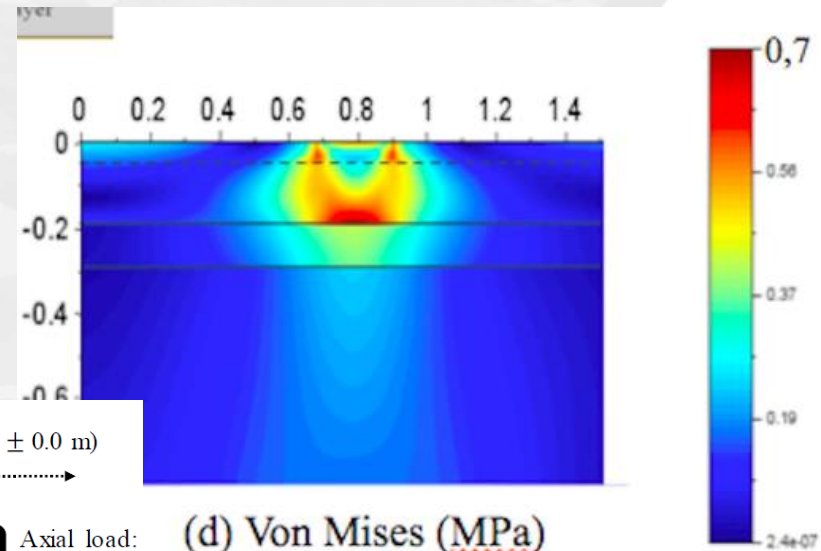

(d) Von Mises (MPa)

M4-5nW

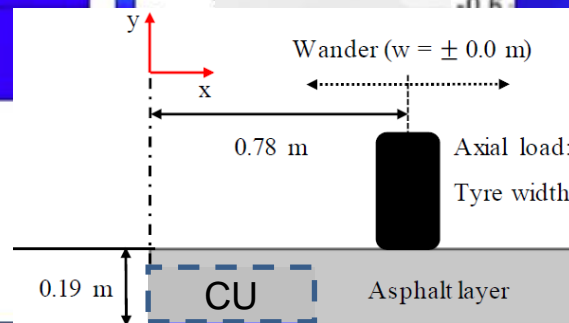

The material in the first layer is at more than 30°C at 10 Hz
When the material in box is same as in layer, results match.



M4-5nW Results

(Deep, 2017)

Results due to load wandering at $w=-0.2$, $E1=1000\text{MPa} = E2$

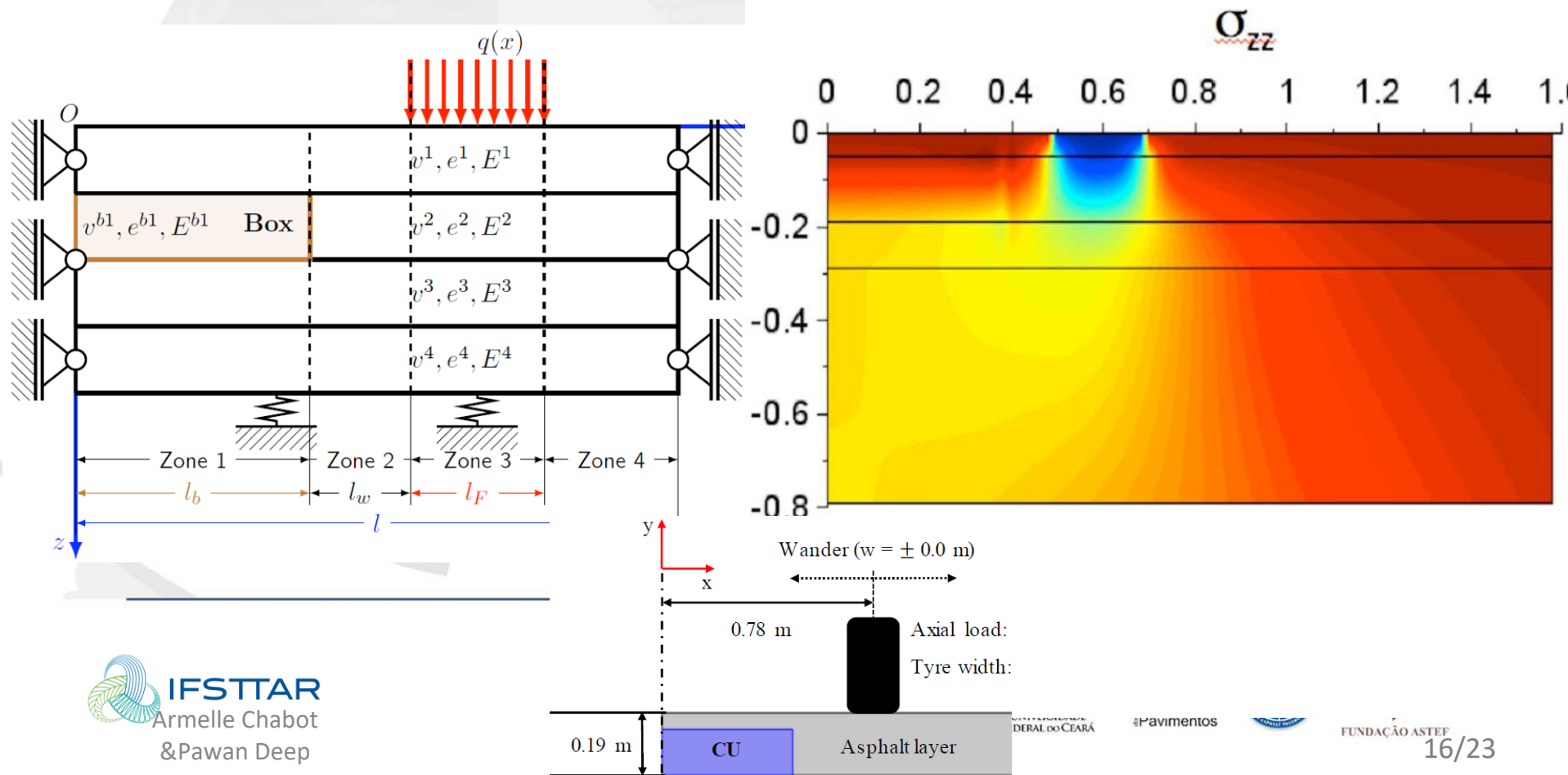



Introducing the vertical crack

Results at $w=0$

Interface Normal stresses

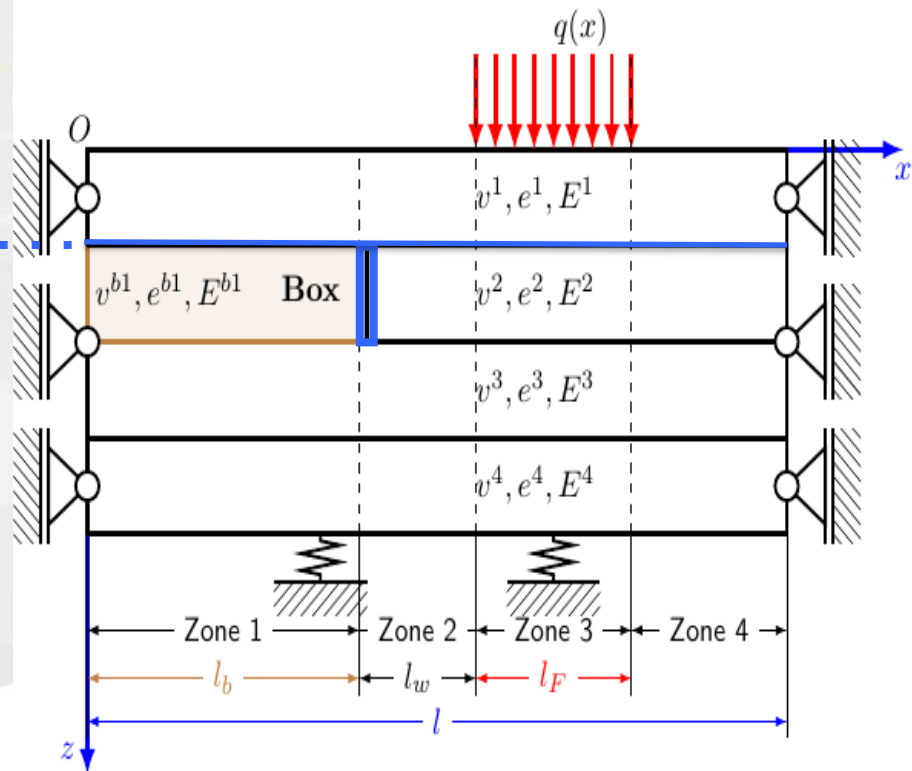
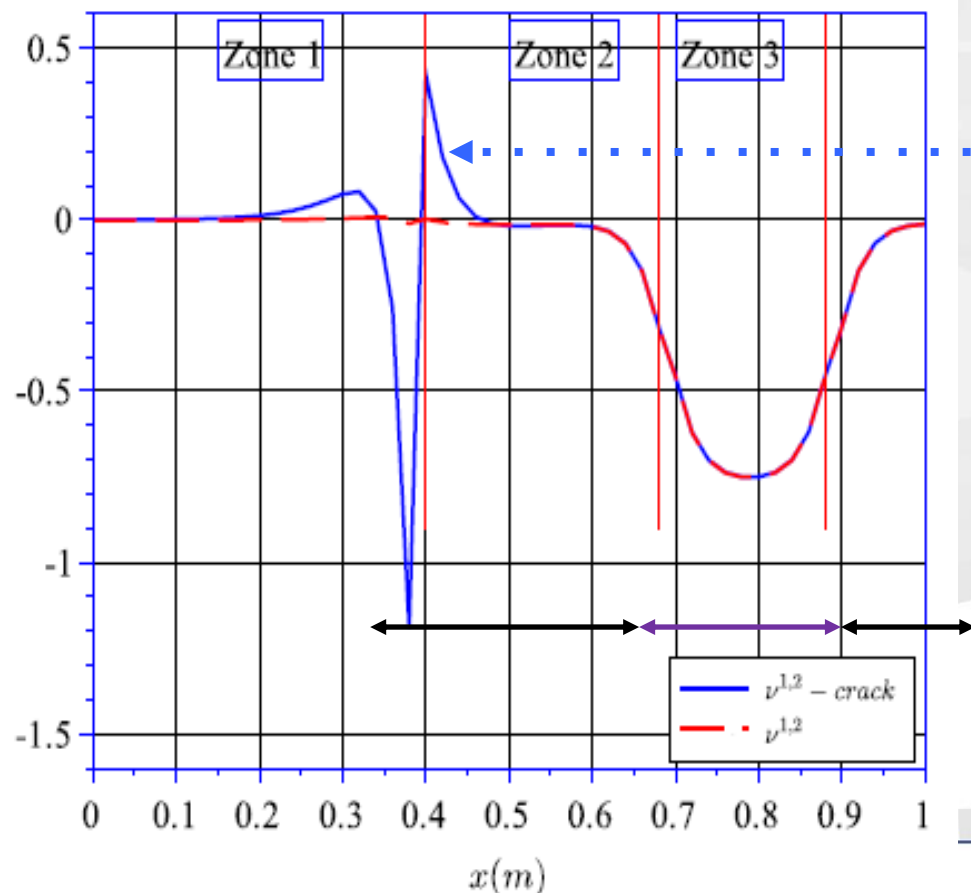

High interface stresses in case of vertical crack at $w=0$

$$n^{1,2}(x) = s_{33}(x, h_1^+) = s_{33}(x, h_2^-)$$



Adaptation of tRoads for eRoads?

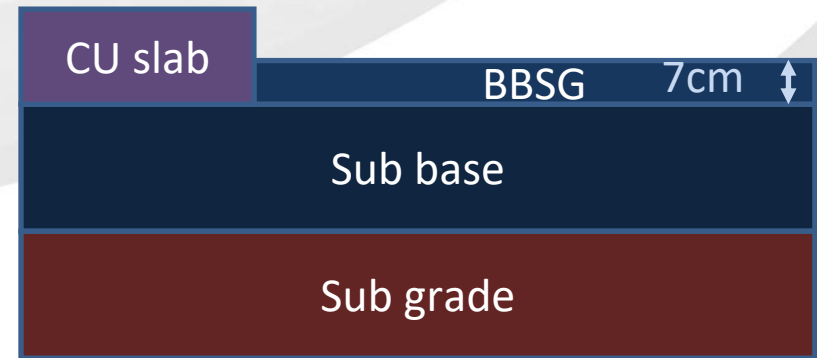
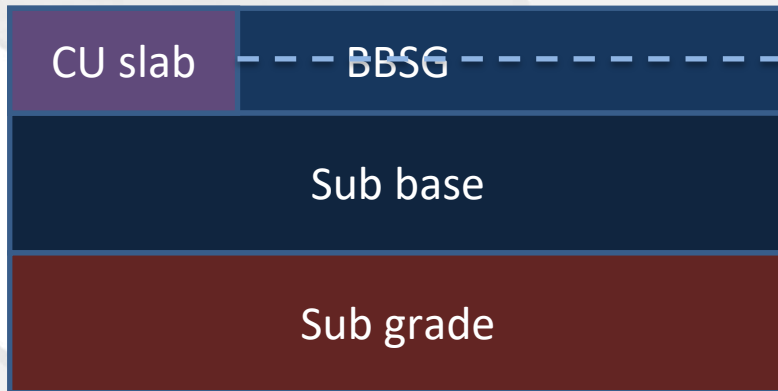
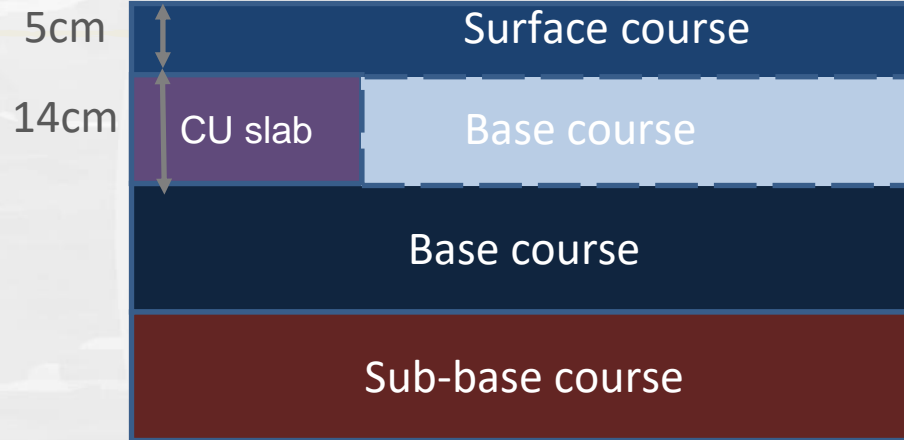



Proposal 1 solution for the Adaption of tRoads

Why not using composite pavement such as UTW?

Knowing that Cement concrete(CC) overlaid on asphalt has a good bond (such as in UTW pavement) (Silfwerbrand,1998) (Pouteau et al., 2004) (Rasmussen et al., 2004) (Hun et al.,CP2012) (Chabot et al., 2008 2013 2017) (Barman et al., 2017) (Mateos, 2017), ...

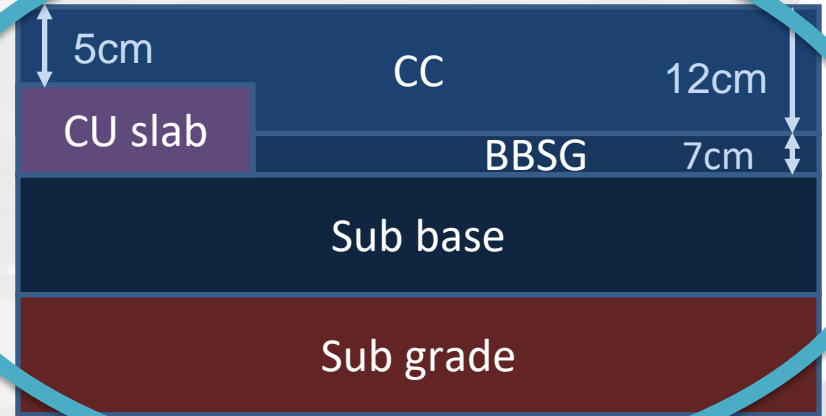

Joints → cables



Proposal

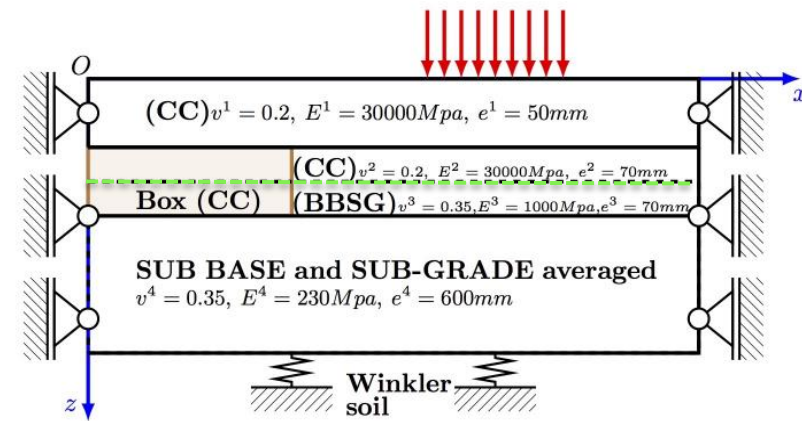
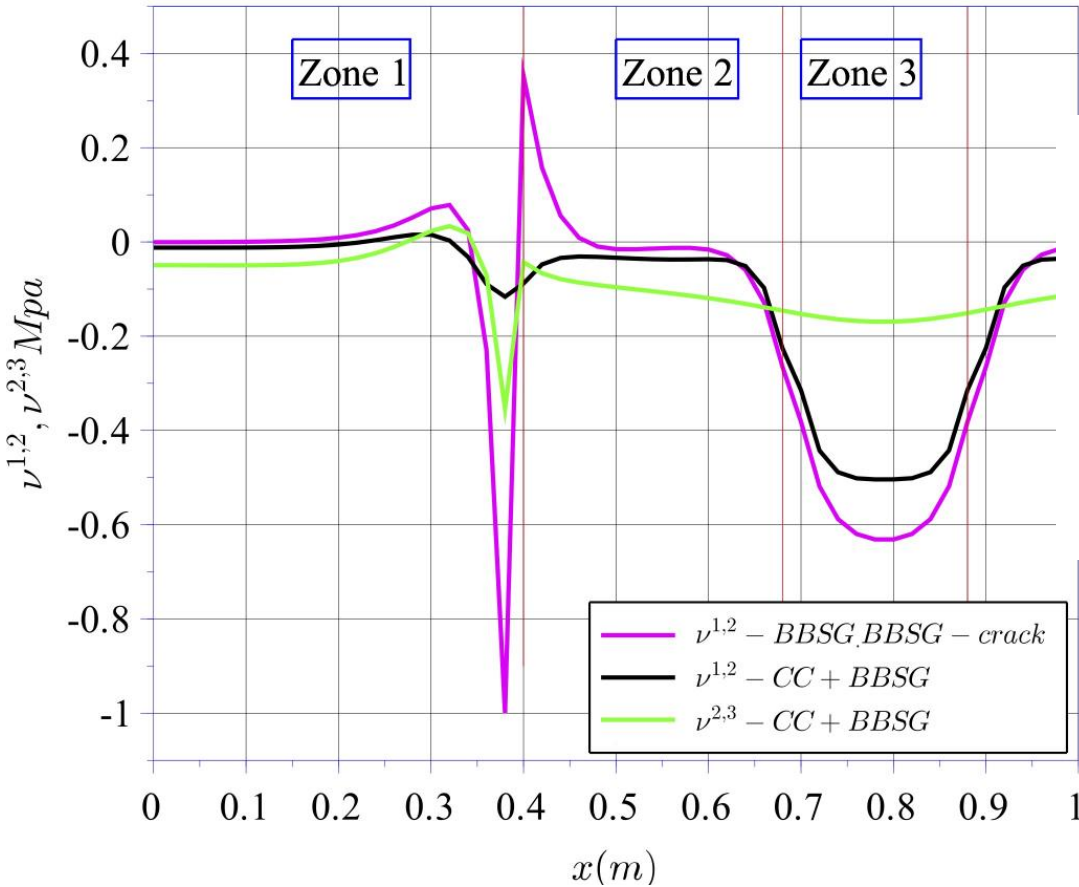

$$n^{1,2}(x) = s_{zz}(x, h_1^+) = s_{zz}(x, h_2^-)$$

$$n^{2,3}(x) = s_{zz}(x, h_2^+) = s_{zz}(x, h_3^-)$$



2018 INTERNATIONAL SOCIETY
FOR ASPHALT PAVEMENTS
ISAP CONFERENCE
JUNE 19th – 21st, 2018 – HOTEL GRAN MARQUISE
FORTALEZA-CEARÁ-BRAZIL

Outlines

- 1 Intro / Context
- 2 M&S design needs: asphalt tRoads → eRoads
- 3 M4-5nW developments for eRoad analysis
- 4 Results and 1 alternative M&S eRoad proposal
- 5 Conclusion & Prospects



2018 INTERNATIONAL SOCIETY
FOR ASPHALT PAVEMENTS
ISAP CONFERENCE
JUNE 19th – 21st, 2018 – HOTEL GRAN MARQUISE
FORTALEZA-CEARÁ-BRAZIL

Conclusion & prospects

eRoad PB tested with viscoelasticity model in (Chen,2016), here discontinuities are studied between the CU & material layer

A better access to interface stress field plays for a better understanding of the PB → need to use alternative modeling

Prospects

- Use of M4-5n 3D new development with FreeFem++ code (Nasser et al., 2018) → Partial debonding boundary conditions
- Lateral loading study according to (Hammoum et al., 2010)
- Thermal gradient effect studies specially for the use of top layers made with CC materials as done by (Chabot et al., 2005)



2018 INTERNATIONAL SOCIETY
FOR ASPHALT PAVEMENTS
ISAP CONFERENCE
JUNE 19th – 21st, 2018 – HOTEL GRAN MARQUISE
FORTALEZA-CEARÁ-BRAZIL



Thanks for your attention

apt 2020

**Accelerated Pavement Testing
6th international conference**

September 21-23, 2020
Nantes, FRANCE

Save the dates!
apt2020.sciencesconf.org





2018 INTERNATIONAL SOCIETY
FOR ASPHALT PAVEMENTS
ISAP CONFERENCE
JUNE 19th - 21st, 2018 - HOTEL GRAN MARQUISE
FORTALEZA - CEARÁ - BRAZIL

Prise en compte de décollement d'interface

Rendre les efforts d'interface nuls sur la surface décollée

Idem : dédoublement des nœuds sur contour de la surface décollée

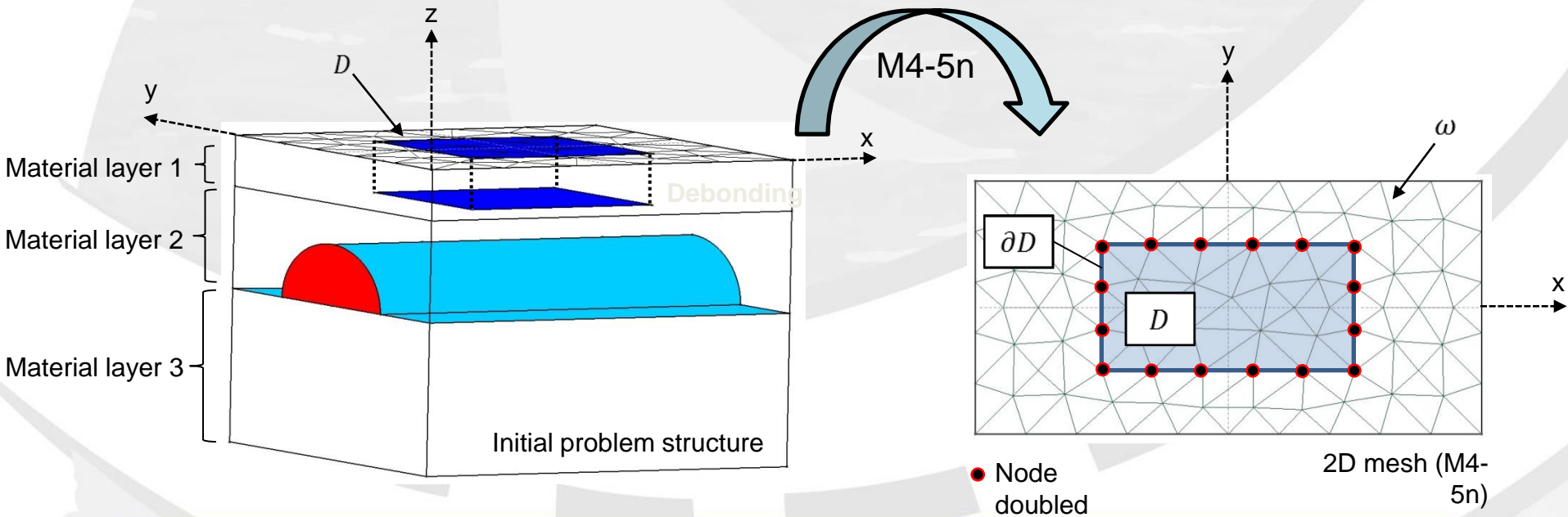

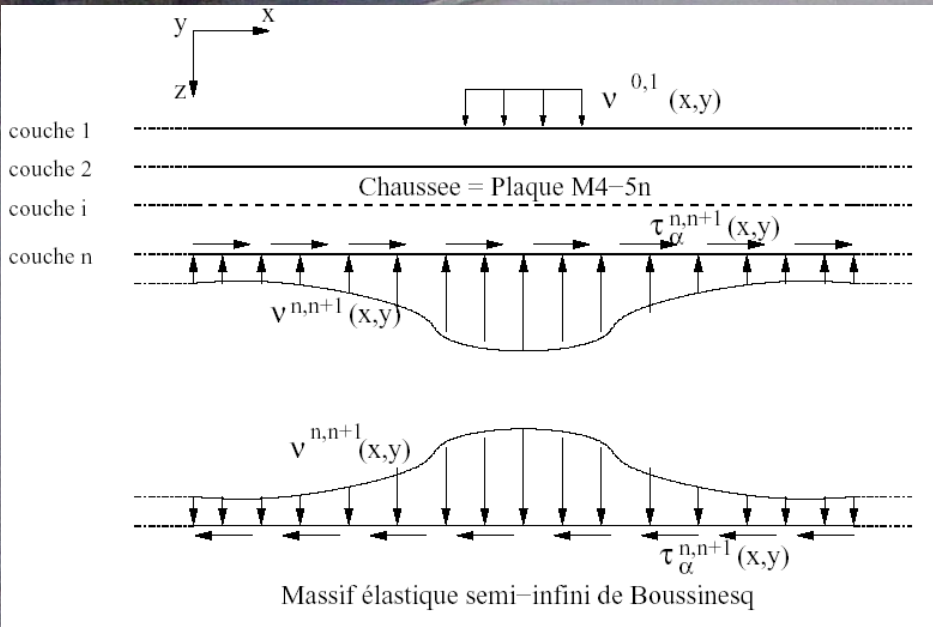

M4-Boussinesq results (Tran, 2004)
 Example of a cracked bi-layers pavement with thermic effects in the Layer 2

